



2024





www.yato.com

Compressors are invaluable support in industry, construction, workshops, and agriculture. They find application wherever compressed air is needed to power devices, blow out drillings, and clean surfaces. The YATO brand offers four models of compressors to best meet user expectations.

Kompresory są nieocenionym wsparciem w przemyśle, na budowie, w warsztacie i rolnictwie. Znajdą zastosowanie wszędzie tam, gdzie sprężone powietrze jest potrzebne do napędzania urządzeń, przedmuchiwania nawierć i czyszczenia powierzchni. Marka YATO oferuje cztery modele kompresorów, aby najlepiej spełnić oczekiwania użytkowników.



YT-23300
24 L



YT-23305
50 L



YT-23310
100 L



YT-23320
200 L



www.yato.com

YATO heaters enhance work comfort by heating the air in garages, workshops, warehouses, and production halls. They find application in facilities where maintaining the appropriate temperature conditions for production, storage, or product processing is necessary. They work well for drying and ventilating spaces during construction and renovation work. The choice of the heater depends on the size of the room, the type of fuel powering the device and the mobility expectations for the equipment.

Nagrzewnice YATO podnoszą komfort pracy ogrzewając powietrze w garażach, warsztatach, magazynach i halach produkcyjnych. Znajdą zastosowanie w obiektach, gdzie konieczne jest utrzymanie odpowiednich warunków temperaturowych do produkcji, składowania lub przetwarzania produktów. Dobrze sprawdzą się podczas suszenia i przewietrzania pomieszczeń w trakcie prac remontowo-budowlanych. Wybór nagrzewnicy zależy od wielkości pomieszczenia, paliwa zasilającego urządzenie i oczekiwań wobec mobilności urządzenia.



YT-99700
2 kW

YT-99705
3 kW

YT-99710
5 kW

**ELECTRIC HEATERS PTC
NAGRZEWNICE
ELEKTRYCZNE PTC**



YT-99720
3 kW

**ELECTRIC HEATER PTC
NAGRZEWNICA
ELEKTRYCZNA PTC**



YT-99730
15 kW

YT-99733
30 kW

**GAS FIRED HEATERS
NAGRZEWNICE GAZOWE**



YT-99740
30 kW

YT-99743
50 kW

**DIRECT OIL FIRED HEATERS
NAGRZEWNICE OLEJOWE**

więcej na stronach:
more on pages:
535-536

1 **SPANNERS / KLUCZE** 6-19

2 **SOCKETS, ACCESSORIES & SETS / KLUCZE NASADOWE, AKCESORIA I ZESTAWY** 20-59

3 **IMPACT SOCKETS, ACCESSORIES & SETS / UDAROWE KLUCZE NASADOWE, AKCESORIA I ZESTAWY** 60-69

4 **TORQUE WRENCHES & TORQUE MULTIPLIERS / KLUCZE DYNAMOMETRYCZNE I WZMACNIACZE MOMENTU** 70-75

5 **SCREWDRIVERS & SCREWDRIVER BITS / WKRĘTAKI I KOŃCÓWKI WKRĘTAKOWE** 76-101

6 **PLIERS / SZCZYPCE** 102-113

7 **ELECTRICIAN TOOLS / NARZĘDZIA DLA ELEKTRYKÓW** 114-133

8 **HAMMERS, CHISELS, PUNCHES & AXES / MŁOTKI, DŁUTA, PRZECINAKI I SIEKIERY** 134-147

9 **CLAMPS, VICES & HOLDERS / ŚCISKI, IMADŁA I WSPORNIKI** 148-153

10 **CUTTING TOOLS / NARZĘDZIA TNĄCE** 154-235

11 **PLUMBING TOOLS / NARZĘDZIA HYDRAULICZNE** 236-253

12

FASTENING TOOLS / NARZĘDZIA DO ŁĄCZENIA

254-273



13

CONSTRUCTION TOOLS / NARZĘDZIA BUDOWLANE

274-299



14

MEASURING TOOLS / NARZĘDZIA MIERNICZE

300-315



15

PNEUMATIC TOOLS / NARZĘDZIA PNEUMATYCZNE

316-341



16

SPECIAL AUTOMOTIVE TOOLS & EQUIPMENT / NARZĘDZIA I WYPOSAŻENIE WARSZTATU SAMOCHODOWEGO

342-487



17

WELDING EQUIPMENT & ACCESSORIES / NARZĘDZIA SPAWALNICZE I AKCESORIA

488-495



18

POWER & GASOLINE TOOLS / ELEKTRONARZĘDZIA I NARZĘDZIA SPALINOWE

496-557

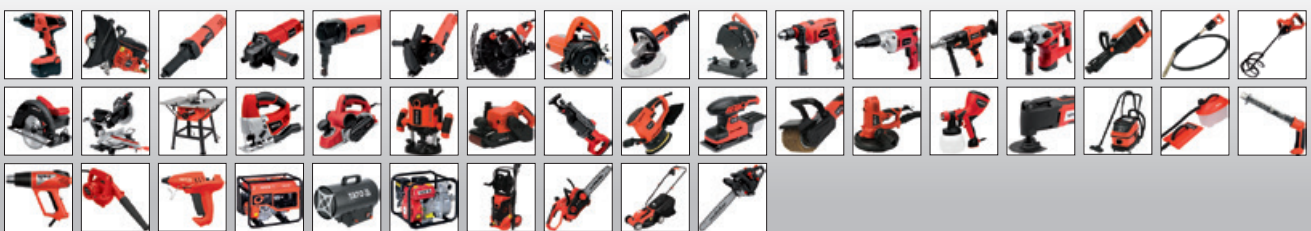

19

ACCESSORIES / AKCESORIA

558-571



20

HEALTH & SAFETY ARTICLES / ARTYKUŁY BHP

572-599



21

ELECTRIC PRODUCTS / ARTYKUŁY ELEKTRYCZNE

600-619



22

GARDEN TOOLS / NARZĘDZIA OGRODNICZE











620-635



1

**Spanners
Klucze**



Combination spanners Klucze płasko-oczkowe	8-9		Half-moon spanners Klucze oczkowe typu „C”	14	
Combination spanners & sets, polished head Klucze płasko-oczkowe i zestawy, polerowana główka	8		Flare nut wrenches & sets Klucze oczkowe półotwarte i zestawy	14	
Stubby combination spanners, polished head Klucze płasko-oczkowe krótkie, polerowana główka	9		Torx ring spanner sets Zestawy kluczy oczkowych „Torx”	14	
Combination ratchet wrenches Klucze płasko-oczkowe z grzechotką	9-10		Torx type double head flexible wrenches & sets Klucze przegubowe „Torx” i zestawy	15	
Combination ratchet wrenches & sets Klucze płasko-oczkowe z grzechotką i zestawy	9		L-type socket wrenches Klucze nasadowe typu „L”	15	
Flexible ratchet combination wrenches Klucze płasko-oczkowe z grzechotką i przegubem	10		Double ratchet wrenches Dwustronne klucze nasadowe z grzechotką	16	
X-handle combination wrenches Klucze płasko-oczkowe skręcone	10-11		T-type socket wrenches Klucze nasadowe typu „T”	16-17	
X-handle combination wrenches & sets Klucze płasko-oczkowe skręcone i zestawy	10		Socket wrenches with handle Klucze nasadowe z rękojeścią	16	
X-handle combination ratchet wrenches Klucze płasko-oczkowe skręcone z grzechotką	11		T-type deep socket wrenches with rotary handle Klucze nasadowe typu „T” z obrotową rączką	16	
Double open end spanners Klucze płaskie	11		T-type adapters with rotary handle Adaptery typu „T” z obrotową rączką	16	
Double open end spanners & sets, polished head Klucze płaskie i zestawy, polerowana główka	11		T-type deep socket wrenches Klucze nasadowe typu „T”	17	
Double ratchet spanner sets Zestawy kluczy oczkowych z grzechotką	12		T-handle swivel socket wrenches Klucze nasadowe typu „T” z przegubem	17	
Bi-hexagonal ring spanners Klucze oczkowe odgięte	12-13		Adjustable wrenches Klucze nastawne	18	
Bi-hexagonal ring spanners & sets, polished head Klucze oczkowe odgięte i zestawy, polerowana główka	12		Flexible hook wrenches Klucze hakowe	18	
Combination ratchet wrenches Klucze oczkowe odgięte z grzechotką	13		Impact wrenches Klucze do pobijania	13	
Impact wrenches Klucze do pobijania	13		Ring impact wrenches Klucze oczkowe do pobijania	13	
Ring impact wrenches Klucze oczkowe do pobijania	13		Open end impact wrenches Klucze płaskie do pobijania	13	
Open end impact wrenches Klucze płaskie do pobijania	13				

EN Combination spanner
 PL Klucz płasko-oczkowy
 DE Maulringschlüssel
 RU Ключ комбинированный
 CZ Plochy a očkový klíč
 HU Kulcs villás-csillag
 RO Cheie combinată
 FR Clé mixte
 IT Chiave combinata
 ES Combinada con llave de estrella
 CN 两用扳手

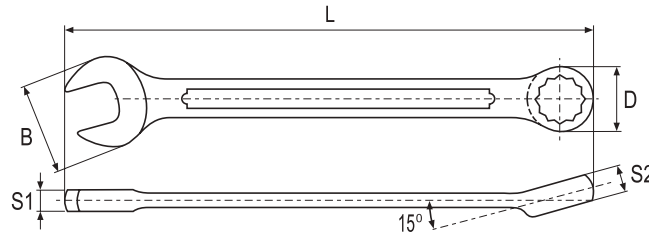

- Application: workshop
- Head offset: 15°
- Surface finish: chromed, satin
- Przeznaczenie: warsztat
- Kąt odchylenia główki: 15°
- Wykończenie powierzchni: chromowana, satynowa

YATO	Ø [mm]	L [mm]	B [mm]	D [mm]	S1 [mm]	S2 [mm]	PCS	ROBE
YT-0335	6	110	14.8	10.5	3.7	4.9	10	300/600
YT-0336	7	120	16.1	11.3	4.0	5.3	10	300/600
YT-0337	8	130	18.5	12.9	4.2	5.0	10	180/360
YT-0338	9	140	20.5	14.6	4.2	5.0	10	180/360
YT-0339	10	150	22.2	16.2	4.9	6.4	10	180/360
YT-0340	11	160	25.5	17.3	4.9	7.0	10	180/360
YT-0341	12	170	26.7	18.7	5.3	7.6	10	120/240
YT-0342	13	180	28.0	19.6	5.5	8.2	10	120/240
YT-0343	14	190	30.3	21.4	5.9	7.7	10	50/100
YT-0344	15	200	32.8	22.8	6.2	8.5	10	50/100
YT-0345	16	210	33.9	23.7	6.1	9.1	10	50/100
YT-0346	17	220	35.9	24.7	6.5	9.1	10	50/100
YT-0347	18	230	37.8	26.9	6.9	10.0	10	50/100

YATO	Ø [mm]	L [mm]	B [mm]	D [mm]	S1 [mm]	S2 [mm]	PCS	ROBE
YT-0348	19	235	38.9	27.7	7.0	10.1	10	50/100
YT-0349	20	250	41.4	29.2	7.3	11.0	10	40/80
YT-0350	21	260	43.4	31.0	7.1	10.9	10	40/80
YT-0351	22	270	45.9	32.2	8.1	11.2	5	20/40
YT-0352	23	280	47.8	34.3	7.8	11.1	5	20/40
YT-0353	24	290	49.9	34.8	9.2	11.2	5	20/40
YT-0354	25	300	51.2	36.6	9.2	12.4	5	20/40
YT-0355	26	310	53.2	37.4	9.2	12.9	5	20/40
YT-0356	27	320	55.9	39.3	9.3	12.7	5	15/30
YT-0357	28	330	56.5	40.9	9.9	13.5	5	15/30
YT-0358	29	340	60.0	42.4	10.0	13.6	5	15/30
YT-0359	30	350	60.9	43.8	10.0	14.7	5	10/20
YT-0360	32	370	64.5	46.6	11.3	14.9	5	10/20

EN Combination spanner
 PL Klucz płasko-oczkowy
 DE Maulringschlüssel
 RU Ключ комбинированный
 CZ Plochy a očkový klíč
 HU Kulcs villás-csillag
 RO Cheie combinată
 FR Clé mixte
 IT Chiave combinata
 ES Combinada con llave de estrella
 CN 两用扳手

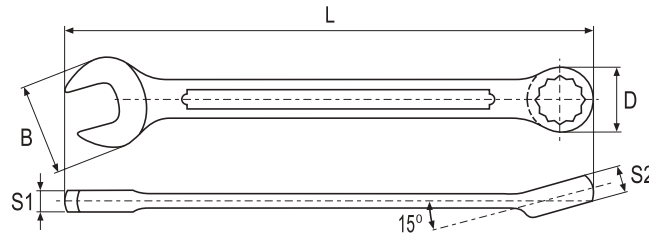

- Application: workshop
- Head offset: 15°
- Surface finish: chromed, satin
- Przeznaczenie: warsztat
- Kąt odchylenia główki: 15°
- Wykończenie powierzchni: chromowana, satynowa

YATO	Ø [mm]	L [mm]	B [mm]	D [mm]	S1 [mm]	S2 [mm]	PCS	ROBE
YT-00760	34	425	65.2	51.0	13.0	16.0	5	5/20
YT-00761	36	460	73.0	57.0	14.0	17.5	5	5/15
YT-00762	38	460	73.0	57.0	14.0	17.5	5	5/15
YT-00763	41	500	83.0	61.5	15.0	19.0	5	5/10
YT-00764	46	540	88.3	69.0	16.5	21.0	5	5/10

YATO	Ø [mm]	L [mm]	B [mm]	D [mm]	S1 [mm]	S2 [mm]	PCS	ROBE
YT-00765	48	570	92.0	72.0	16.5	22.0	5	5/10
YT-00766	50	598	96.0	74.0	18.0	23.5	2	2/8
YT-00767	55	620	105.6	82.4	19.0	25.0	2	2/6
YT-00768	60	660	115.2	89.8	21.0	27.0	2	2/6
YT-00769	65	680	124.8	97.3	23.0	29.0	2	2/4

EN Combination spanner set
 PL Komplet kluczy płasko-oczkowych
 DE Maulringschlüsselsatz
 RU Набор ключей комбинированных
 CZ Souprava plochých a očkových klíčů
 HU Kulcskészlet, villás-csillag
 RO Set chei combinate
 FR Set de clés mixtes
 IT Set chiave combinata
 ES Juego de combinadas con llave de estrella
 CN 两用扳手组套

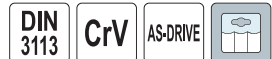

12 PCS

YATO	Ø [mm]	PCS
YT-0362	8, 9, 10, 11, 12, 13, 14, 15, 17, 19, 22, 24	6



17 PCS

YATO	Ø [mm]	PCS
YT-0363	8, 9, 10, 11, 12, 13, 14, 15, 16, 17, 18, 19, 22, 24, 27, 30, 32	3



25 PCS

YATO	Ø [mm]	PCS
YT-0365	6, 7, 8, 9, 10, 11, 12, 13, 14, 15, 16, 17, 18, 19, 20, 21, 22, 23, 24, 25, 26, 27, 28, 30, 32	3

EN Stubby combination spanner
 PL Klucz płasko-oczkowy krótki
 DE Maulringschlüssel
 RU Ключ комбинированный
 CZ Plochý a očkový klíč
 HU Kulcs villás-csillag
 RO Cheie combinată
 FR Clé mixte courte
 IT Chiave combinata corta
 ES Combinada con llave de estrella
 CN 两用短扳手

CrV AS-DRIVE

1

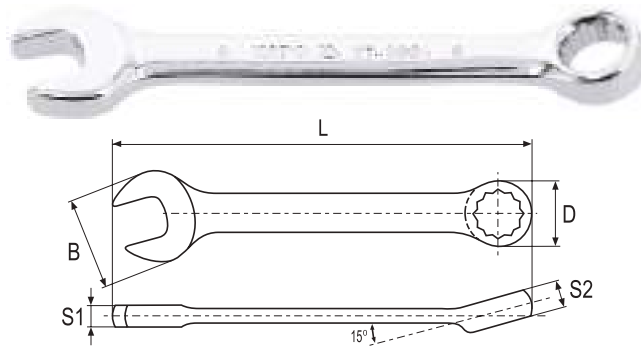

• Application: workshop
 • Head offset: 15°
 • Surface finish: chromed

• Przeznaczenie: warsztat
 • Kąt odchylenia głowki: 15°
 • Wykończenie powierzchni: chromowana

YATO	Ø [mm]	L [mm]	B [mm]	D [mm]	S1 [mm]	S2 [mm]	PCS ROZB	Box
YT-4901	8	91	19.2	13.9	5.0	6.3	10	120/240
YT-4902	9	97	21.7	16.4	5.4	6.4	10	120/240
YT-4903	10	97	21.9	16.6	5.2	6.4	10	120/240
YT-4904	11	100	23.2	18.3	5.9	7.2	10	120/240
YT-4905	12	108	27.4	20.2	6.4	7.6	10	120/240
YT-4906	13	109	27.9	20.7	6.7	7.7	10	120/240

YATO	Ø [mm]	L [mm]	B [mm]	D [mm]	S1 [mm]	S2 [mm]	PCS ROZB	Box
YT-4907	14	115	29.3	22.1	6.1	8.3	10	60/120
YT-4908	15	120	31.2	24.0	6.8	9.6	10	60/120
YT-4909	16	121	32.0	24.3	6.8	9.6	10	60/120
YT-4910	17	128	36.6	27.1	7.4	9.9	10	60/120
YT-4911	18	127	36.2	26.8	7.4	9.9	10	60/120
YT-4912	19	135	39.2	19.5	8.8	10.8	10	60/120

EN Combination ratchet wrench
 PL Klucz płasko-oczkowy z grzechotką
 DE Ratschenringmaulschlüssel
 RU Ключ комбинированный с трещоткой
 CZ Klíč očkoplochý ráčnový
 HU Csillag-villás kulcs racsnis
 RO Cheie combinată cu crichet
 FR Clé mixte à cliquet
 IT Chiave combinata a cricchetto reversibile
 ES Llave combinada fija abierta y carraca
 CN 棘轮两用扳手

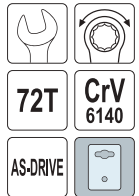

• Application: service
 • 72 teeth ratchet
 • Minimum operation angle: 5°
 • Surface finish: chromed, mirror

• Przeznaczenie: serwis
 • Grzechotka 72 zębów
 • Minimalny kąt pracy: 5°
 • Wykończenie powierzchni: chromowana, polerowana

YATO	Ø [mm]	L [mm]	B [mm]	D [mm]	S1 [mm]	S2 [mm]	PCS ROZB	Box
YT-01906	6	120	14.7	18.0	4.0	6.5	10	50/100
YT-01907	7	130	16.2	18.0	4.3	7.0	10	50/100
YT-01908	8	141	17.6	18.2	4.8	7.2	10	50/100
YT-01909	9	151	19.4	20.4	4.8	7.4	10	50/100
YT-0191	10	160	22.1	22.2	6.0	7.8	10	50/100
YT-0192	11	165	24.7	24.2	6.6	8.5	10	50/100
YT-0193	12	170	26.4	25.5	6.7	8.9	10	50/100
YT-0194	13	180	27.5	26.7	6.6	9.2	10	50/100
YT-0195	14	190	30.8	29.0	7.4	9.4	10	50/100
YT-0196	15	200	32.9	30.8	7.7	10.1	10	50/100
YT-0197	16	210	34.3	31.5	7.8	10.3	10	50/100

YATO	Ø [mm]	L [mm]	B [mm]	D [mm]	S1 [mm]	S2 [mm]	PCS ROZB	Box
YT-0198	17	225	36.8	33.6	8.4	10.6	10	50/100
YT-0199	18	235	39.2	35.6	9.1	10.8	10	50/100
YT-0200	19	245	40.1	37.3	9.5	11.3	10	50/100
YT-0189	21	290	45.2	43.0	9.9	13.3	6	30/60
YT-0201	22	290	45.6	44.2	10.5	13.4	6	24/48
YT-0202	24	335	52.8	50.0	11.3	14.5	6	48
YT-0203	25	335	52.0	47.4	10.2	14.3	6	48
YT-0204	27	355	55.6	52.7	10.9	15.7	6	30
YT-0205	30	400	62.5	57.7	12.2	17.1	6	24
YT-0206	32	420	65.0	61.7	13.2	17.9	6	24

EN Combination ratchet wrench set
 PL Komplet kluczy płasko-oczkowych z grzechotką
 DE Knarrenringmaulschlüssel-Satz
 RU Набор комбинированных ключей с трещоткой
 CZ Klíče ráčnové sada
 HU Racsnis csillag-villás kulcs készlet
 RO Set chei combinată
 FR Set de clés mixte à cliquet
 IT Set chiavi combinata a cricchetto
 ES Juego de llaves planas con matraca
 CN 棘轮扳手组套



YATO	Ø [mm]	Box
YT-0208	10, 12, 13, 14, 15, 17, 19	10/20

1

- EN Combination ratchet wrench
- PL Klucz płasko-oczkowy z grzechotką
- DE Ratschenringmaulschlüssel
- RU Ключ комбинированный с трещоткой
- CZ Klíč očkoplochy ráčnový
- HU Csillag-villás kulcs racsnis
- RO Cheie combinata cu crichet
- FR Clé mixte à cliquet
- IT Chiave combinata a cricchetto reversibile
- ES Llave combinada fija abierta y carraca
- CN 双向棘轮两用扳手

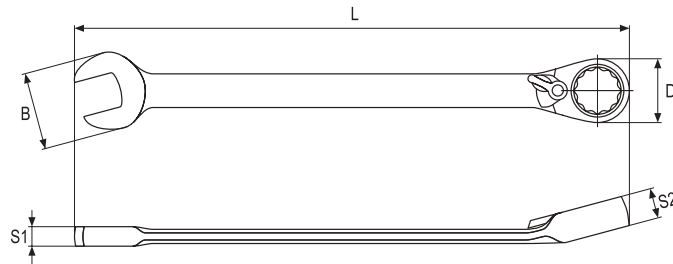
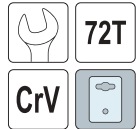

YATO	Ø [mm]	L [mm]	B [mm]	D [mm]	S1 [mm]	S2 [mm]	PCS	PCB
YT-1651	8	140	17.5	19.0	6.0	7.2	10	50/100
YT-1652	9	150	19.8	20.7	6.4	7.5	10	50/100
YT-1653	10	160	22.1	23.1	6.4	7.9	10	50/100
YT-1654	11	165	23.9	25.0	6.6	8.4	10	50/100
YT-1655	12	170	27.1	26.0	6.5	8.9	10	50/100
YT-1656	13	180	27.9	27.6	7.1	9.1	10	50/100
YT-1657	14	190	31.6	28.3	7.3	9.5	10	50/100
YT-1658	15	200	32.8	31.4	8.1	9.8	10	50/100
YT-1659	16	210	33.9	32.9	8.4	10.3	10	50/100
YT-1660	17	225	38.0	34.5	8.7	10.5	10	50/100
YT-1661	18	235	39.8	36.9	9.3	10.7	10	50/100

YATO	Ø [mm]	L [mm]	B [mm]	D [mm]	S1 [mm]	S2 [mm]	PCS	PCB
YT-1662	19	245	41.8	38.3	9.5	11.3	10	50/100
YT-1663	20	245	41.9	38.1	9.7	11.4	6	30/60
YT-1664	21	290	44.9	43.0	9.8	13.6	6	30/60
YT-1665	22	290	44.8	43.8	10.0	13.6	6	30/60
YT-1666	23	290	44.9	43.3	10.3	13.7	6	24/48
YT-1667	24	330	52.0	49.4	10.2	14.5	6	24/48
YT-1669	26	360	56.3	53.6	12.1	15.7	6	30
YT-1670	27	360	55.6	52.9	12.2	16.1	6	30
YT-1671	28	360	56.1	53.6	12.6	16.0	6	24
YT-1672	30	400	62.1	58.0	11.9	17.2	6	24
YT-1673	32	420	64.1	62.0	12.9	17.7	6	24

- EN Flexible ratchet combination wrench
- PL Klucz płasko-oczkowy z grzechotką i przegubem
- DE Ratschenringmaulschlüssel
- RU Ключ комбинированный с трещоткой
- CZ Klíč očkoplochy ráčnový
- HU Csillag-villás kulcs racsnis
- RO Cheie combinata cu crichet
- FR Clé mixte à cliquet tête articulée
- IT Chiave combinata a cricchetto testa mobile
- ES Llave combinada fija abierta y carraca
- CN 活头棘轮两用扳手

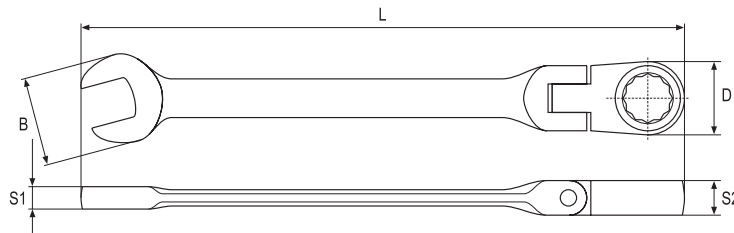

YATO	Ø [mm]	L [mm]	B [mm]	D [mm]	S1 [mm]	S2 [mm]	PCS	PCB
YT-1674	8	140	18.0	19.6	6.3	7.3	10	50/100
YT-1675	9	145	19.7	21.1	4.7	7.6	10	50/100
YT-1676	10	160	22.8	23.2	6.3	7.8	10	50/100
YT-1677	11	160	24.0	24.7	5.4	8.5	10	50/100
YT-1678	12	170	26.4	26.7	6.8	8.8	10	50/100
YT-1679	13	180	28.4	27.3	7.2	9.1	10	50/100
YT-1680	14	185	29.5	28.7	6.8	9.4	10	50/100
YT-1681	15	195	32.9	30.8	7.2	9.8	10	50/100

YATO	Ø [mm]	L [mm]	B [mm]	D [mm]	S1 [mm]	S2 [mm]	PCS	PCB
YT-1682	16	210	34.4	33.3	7.6	10.3	10	50/100
YT-1683	17	230	36.7	35.7	8.3	10.5	10	50/100
YT-1684	18	235	39.0	35.9	8.0	10.8	10	50/100
YT-1685	19	245	40.8	37.6	9.5	11.2	10	50/100
YT-1686	20	245	40.9	38.2	8.8	11.1	6	30/60
YT-1687	21	290	45.0	42.8	9.8	13.6	6	30/60
YT-1688	22	290	45.2	42.7	9.8	13.5	6	30/60
YT-1690	24	330	51.3	48.7	10.4	14.5	6	24/48

- EN Combination spanner
- PL Klucz płasko-oczkowy
- DE Maulringschlüssel
- RU Ключ комбинированный
- CZ Plochy a očkový klíč
- HU Kulcs villás-csillag
- RO Cheie combinată
- FR Clé mixte
- IT Chiave combinata
- ES Combinada con llave de estrella
- CN 两用扳手

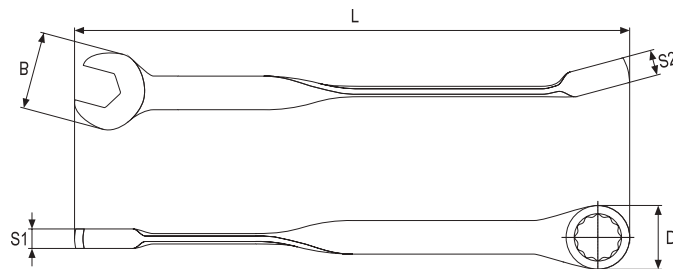

YATO	Ø [mm]	L [mm]	B [mm]	D [mm]	S1 [mm]	S2 [mm]	PCS	PCB
YT-01851	10	165	20.6	15.7	5.9	7.1	100/200	
YT-01852	12	204	25.6	20.2	7.0	8.0	40/120	
YT-01853	13	204	25.5	20.0	6.8	8.2	40/120	
YT-01854	14	216	28.4	21.4	7.2	8.4	40/120	

YATO	Ø [mm]	L [mm]	B [mm]	D [mm]	S1 [mm]	S2 [mm]	PCS	PCB
YT-01855	15	230	30.9	25.1	7.4	9.4	40/120	
YT-01856	17	244	34.5	26.8	7.7	10.0	40/80	
YT-01858	19	259	38.4	28.9	8.0	9.9	40/80	

- EN Combination spanner set
- PL Komplet kluczy płasko-oczkowych
- DE Maulringschlüsselsatz
- RU Набор ключей комбинированных
- CZ Souprava plochých a očkových klíčů
- HU Kulcskészlet, villás-csillag
- RO Set chei combinate rasucite
- FR Set de clés mixtes
- IT Set di chiavi combinate
- ES Juego de combinadas con llave de estrella
- CN 两用扳手组套



14
PCS



YATO	Ø [mm]	Icon
YT-01865	10, 12, 13, 14, 15, 17, 18, 19, 21, 22, 24, 27, 30, 32	4

- EN Combination ratchet wrench
- PL Klucz płasko-oczkowy z grzechotką
- DE Ratschenringmaulschlüssel
- RU Ключ комбинированный с трещоткой
- CZ Klíč oškorlochý ráčnový
- HU Csillag-villás kulcs rácsnis
- RO Cheie combinata răsucită cu clichet
- FR Clé mixte à cliquet
- IT Chiave combinata a cricchetto
- ES Llave combinada fija abierta y carraca
- CN X柄两用棘轮扳手



72T

CrV
50BV30

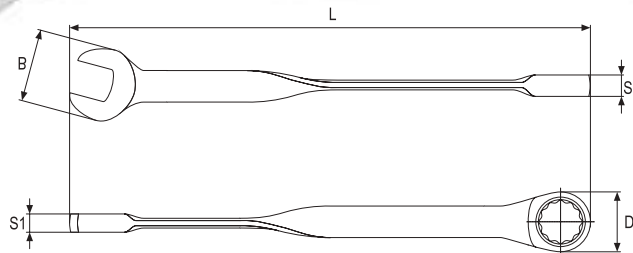

YATO	Ø [mm]	L [mm]	B [mm]	D [mm]	S1 [mm]	S2 [mm]	Icon
YT-01870	8	153	20.0	21.2	5.0	8.2	25/200
YT-01872	10	167	24.8	24.9	6.3	9.0	25/200
YT-01874	12	177	27.7	27.1	6.5	9.5	25/150
YT-01875	13	182	29.5	28.3	7.1	9.5	25/150

YATO	Ø [mm]	L [mm]	B [mm]	D [mm]	S1 [mm]	S2 [mm]	Icon
YT-01876	14	192	32.3	31.5	7.7	9.6	25/100
YT-01877	15	201	34.3	30.9	7.3	9.6	25/100
YT-01879	17	228	38.7	35.3	8.0	10.7	20/80

- EN Double open end spanner
- PL Klucz płaski
- DE Doppelmaulschlüssel
- RU Ключ рожковый
- CZ Plochý klíč
- HU Villáskulcs
- RO Cheie fixă
- FR Clé plate
- IT Chiave piatta
- ES Llave fija
- CN 双头呆扳手



DIN
3110

CrV

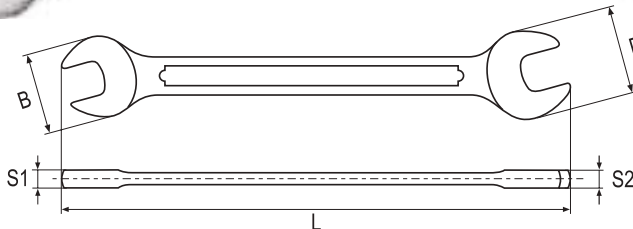

* Surface finish: chromed, satin / mirror

* Wykończenie powierzchni: chromowana, satynowa / polerowana

YATO	Ø [mm]	L [mm]	B [mm]	D [mm]	S1 [mm]	S2 [mm]	PCS PIECE	Icon
YT-0367	6x7	120	15.1	16.8	3.5	3.6	10	360/720
YT-0368	8x9	140	18.7	20.8	3.7	3.6	10	180/360
YT-0369	10x11	155	22.4	25.5	4.6	4.6	10	150/300
YT-0332	10x13	170	22.5	29.3	4.6	5.3	10	150/300
YT-0370	12x13	170	27.1	29.3	4.9	5.3	10	80/160
YT-0333	13x17	180	29.3	37.5	5.3	6.3	10	50/100
YT-0371	14x15	180	31.0	33.0	5.3	5.4	10	80/160
YT-0372	16x17	200	34.9	37.5	6.5	6.3	10	50/100

YATO	Ø [mm]	L [mm]	B [mm]	D [mm]	S1 [mm]	S2 [mm]	PCS PIECE	Icon
YT-0334	17x19	220	37.5	38.7	6.3	6.3	10	50/100
YT-0373	18x19	220	38.7	41.0	6.6	6.3	10	50/100
YT-0374	20x22	230	42.1	46.8	7.1	6.8	10	30/60
YT-0375	21x23	245	44.4	48.6	7.3	6.9	10	30/60
YT-0376	24x27	260	51.6	56.9	8.1	8.1	5	20/40
YT-0377	25x28	270	52.3	57.9	8.4	8.3	5	20/40
YT-0378	30x32	295	61.4	65.1	8.0	8.6	5	15/30

- EN Double open end spanner set
- PL Komplet kluczy płaskich
- DE Doppelmaulschlüsselsatz
- RU Набор рожковых ключей
- CZ Souprava plochých klíčů
- HU Kulcskészlet, villás
- RO Set chei fixe
- FR Set de clés à tête fendue
- IT Set di chiavi piatte
- ES Juego de llaves fijas
- CN 双头呆扳手组套



DIN
3110

CrV



10
PCS

YATO	Ø [mm]	Icon
YT-0380	6x7, 8x9, 10x11, 12x13, 14x15, 16x17, 18x19, 20x22, 21x23, 24x27	6

12
PCS

YATO	Ø [mm]	Icon
YT-0381	6x7, 8x9, 10x11, 12x13, 14x15, 16x17, 18x19, 20x22, 21x23, 24x27, 25x28, 30x32	8

1

EN Double ratchet spanner set
 PL Klucze oczkowe z grzechotką
 DE Ringschlüsselsatz
 RU Набор ключей накидных
 CZ Očkové klíče
 HU Csillagkulcs készlet
 RO Set chei inelare
 FR Set de clés à oeil à cliquet
 IT Set chiavi a criochetto
 ES Llaves de anillo
 CN 双头梅花棘轮扳手组套



5
PCS

72T

CrV
6140

YATO	Ø [mm]	PCS
YT-5038	8x9, 10x11, 12x13, 14x15, 17x19	10/30

EN Bi-hexagonal ring spanner
 PL Klucz oczkowy odgięty
 DE Doppelringschlüssel
 RU Ключ накидной изогнутый
 CZ Očkový klíč ohnutý
 HU Hajlítottszerű csillagkulcs
 RO Cheie inelaro-curbată
 FR Clé contre-coudée
 IT Chiave poligonale doppio piegato
 ES Llave de estrella
 CN 双头高颈梅花扳手

DIN
838

CrV

AS-DRIVE

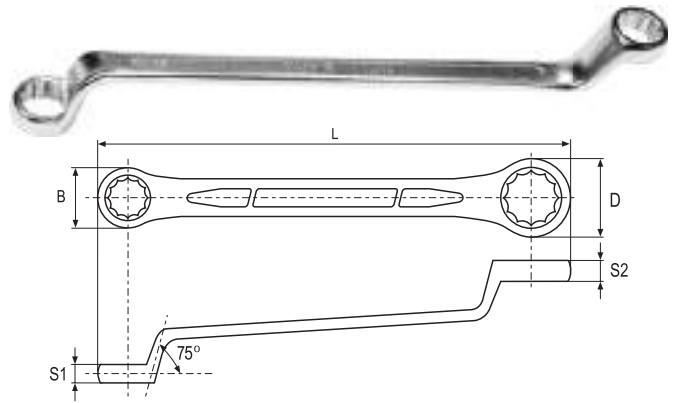

- Application: industry
- Surface finish: chromed, satin / mirror
- Przeznaczenie: przemysł
- Wykończenie powierzchni: chromowana, satynowa / polerowana

YATO	Ø [mm]	L [mm]	B [mm]	D [mm]	S1 [mm]	S2 [mm]	PCS
YT-03950	6x7	165	11.0	12.7	5.4	5.5	10/400
YT-03951	8x9	185	13.9	15.5	6.8	7.2	10/200
YT-03952	10x11	200	16.3	17.6	6.8	7.2	10/200
YT-03953	12x13	220	19.6	21.5	7.2	7.7	10/120
YT-03954	14x15	230	23.6	21.9	8.9	9.1	10/100
YT-03955	16x17	255	24.6	26.4	8.6	9.3	10/60
YT-03956	18x19	270	27.5	28.8	10.5	10.2	5/50

EN Bi-hexagonal ring spanner
 PL Klucz oczkowy odgięty
 DE Doppelringschlüssel
 RU Ключ накидной изогнутый
 CZ Očkový klíč ohnutý
 HU Hajlítottszerű csillagkulcs
 RO Cheie inelaro-curbată
 FR Clé contre-coudée
 IT Chiave poligonale doppio piegato
 ES Llave de estrella
 CN 双头高颈梅花扳手



DIN
838

CrV

AS-DRIVE

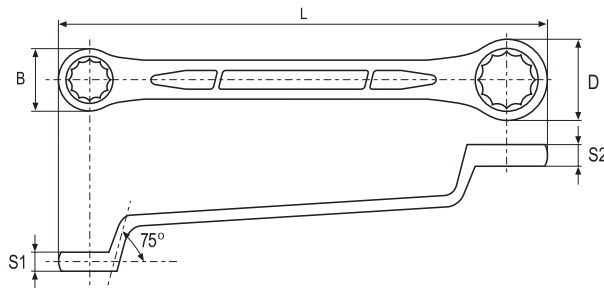

- Application: industry
- Surface finish: chromed, satin / mirror
- Przeznaczenie: przemysł
- Wykończenie powierzchni: chromowana, satynowa / polerowana

YATO	Ø [mm]	L [mm]	B [mm]	D [mm]	S1 [mm]	S2 [mm]	PCS
YT-0383	6x7	165	11.0	12.7	5.4	5.5	10
YT-0384	8x9	185	13.9	15.5	6.8	7.2	10
YT-0385	10x11	200	16.3	17.6	6.8	7.2	10
YT-0386	12x13	220	19.6	21.5	7.2	7.7	10
YT-0387	14x15	230	23.6	21.9	8.9	9.1	10
YT-0388	16x17	255	24.6	26.4	8.6	9.3	10

YATO	Ø [mm]	L [mm]	B [mm]	D [mm]	S1 [mm]	S2 [mm]	PCS
YT-0389	18x19	270	27.5	28.8	10.5	10.2	5
YT-0390	20x22	290	30.9	33.4	10.5	11.4	5
YT-0391	21x23	310	31.9	34.4	11.8	12.4	5
YT-0392	24x27	330	36.2	40.6	11.5	13.2	5
YT-0394	30x32	390	44.0	47.1	13.8	14.9	3

EN Bi-hexagonal ring spanner set
 PL Komplet kluczy oczkowych odgiętych
 DE Doppelringschlüsselsatz
 RU Набор ключей накидных изогнутых
 CZ Klíče očkové vyhnuté sada
 HU Csillagkulcs készlet
 RO Set chei inelare cu cot
 FR Set de clés contre-coudées
 IT Set chiavi poligonali doppie piegate
 ES Juego de llaves de estrella acodadas
 CN 双头高颈梅花扳手组套



DIN
838

CrV

AS-DRIVE

8
PCS

YATO	Ø [mm]	PCS
YT-0396	6x7, 8x9, 10x11, 12x13, 14x15, 16x17, 18x19, 20x22	6

12
PCS

YATO	Ø [mm]	PCS
YT-0398	6x7, 8x9, 10x11, 12x13, 14x15, 16x17, 18x19, 20x22, 21x23, 24x27, 25x28, 30x32	4

- EN Combination ratchet wrench
- PL Klucz oczkowy odgięty z grzechotką
- DE Kombinationsratchetschlüssel
- RU Трещотка для бит
- CZ Kombinovaný rohatkový klíč
- HU Kombinált racsnis kulcs
- RO Antrenor cu clichet combinat
- FR Clé mixte à cliquet
- IT Chiave ad anello piegata a cricchetto
- ES Llave de trinquete combinada
- CN 双向棘轮扳手

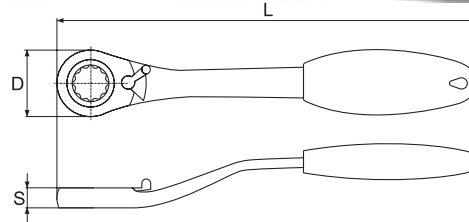

YATO	Ø [mm]	L [mm]	D [mm]	S [mm]	📦
YT-02370	8	140	18	8	10/200
YT-02371	9	145	22	8	10/200
YT-02372	10	145	23	8	10/200
YT-02373	11	170	24	9	10/100
YT-02374	12	175	24	9	10/100
YT-02375	13	190	30	9	10/100
YT-02376	14	195	31	10	10/100
YT-02377	15	195	31	10	10/100
YT-02378	16	195	31	11	10/100
YT-02379	17	225	35	11	10/60

YATO	Ø [mm]	L [mm]	D [mm]	S [mm]	📦
YT-02380	18	225	35	11	10/60
YT-02381	19	225	36	11	10/60
YT-02382	20	250	43	13	5/40
YT-02383	21	250	43	14	5/40
YT-02384	22	250	43	14	5/40
YT-02385	24	265	47	15	5/40
YT-02386	27	280	50	15	5/20
YT-02387	30	290	57	17	5/20
YT-02388	32	290	57	18	5/20

- EN Ring impact wrench
- PL Klucz do pobijania oczkowy
- DE Schlagringschlüssel
- RU Ключ закрытый для растряски
- CZ Klíč maticový očkový rázový
- HU Útőcsillagkulcs
- RO Cheie inelară cu bătător
- FR Clé à frapper à oeil
- IT Chiave poligonale semplice a percussione
- ES Llave de muletilla para usarse dando golpes
- CN 敲击梅花扳手

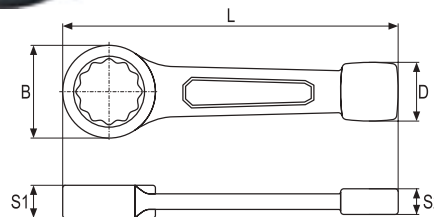

- Application: industry
- 12 point profile
- AS-DRIVE system
- Drop forged
- Surface finish: black oxidised

- Przeznaczenie: przemysł
- Profil 12-kątny
- System AS-DRIVE
- Kute
- Wykończenie powierzchni: czarna, oksydowana

YATO	Ø [mm]	L [mm]	B [mm]	D [mm]	S1 [mm]	S2 [mm]	📦
YT-1601	24	160	41	31	15.0	10	5/25
YT-1602	27	185	47	33	15.0	12	5/25
YT-1603	30	190	51	35	16.5	14	5/25
YT-1604	32	195	54	37	16.5	15	5/25
YT-1605	36	210	60	39	20.0	17	5/10
YT-1606	38	210	60	39	20.0	17	5/10
YT-1607	41	225	66	42	20.0	18	5/10

YATO	Ø [mm]	L [mm]	B [mm]	D [mm]	S1 [mm]	S2 [mm]	📦
YT-1608	46	240	74	44	22.0	19	5/10
YT-1609	50	250	80	45	23.0	20	5/10
YT-1610	55	270	86	55	25.0	22	5/10
YT-1611	58	270	86	55	25.0	22	5
YT-1612	60	270	92	60	25.0	23	5
YT-1613	65	290	100	65	30.0	24	5
YT-1614	70	310	108	70	32.0	25	5

- EN Open end impact wrench
- PL Klucz do pobijania płaski
- DE Schlagschraubenschlüssel
- RU Ключ плоский для растряски
- CZ Klíč maticový plochý rázový
- HU Útőlaposkulcs
- RO Cheie fixă cu bătător
- FR Clé à frapper plate
- IT Chiave a forchetta semplice a percussione
- ES Llave de boca abierta para usarse dando golpes
- CN 敲击开口扳手

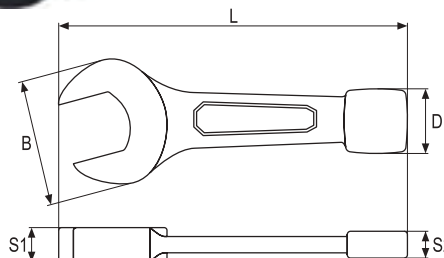
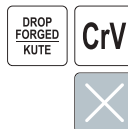

- Application: industry
- Head offset: 15°
- Drop forged
- Surface finish: black oxidised

- Przeznaczenie: przemysł
- Kąt odchylenia główki: 15°
- Kute
- Wykończenie powierzchni: czarna, oksydowana

YATO	Ø [mm]	L [mm]	B [mm]	D [mm]	S1 [mm]	S2 [mm]	📦
YT-1615	27	180	55	33	15	12	5/25
YT-1616	30	187	63	35	17	14	5/25
YT-1617	32	195	67	37	18	15	5/25
YT-1618	36	210	77	39	18	17	5/10

YATO	Ø [mm]	L [mm]	B [mm]	D [mm]	S1 [mm]	S2 [mm]	📦
YT-1619	41	225	89	42	20	18	5/10
YT-1620	46	255	98	44	20	19	5/10
YT-1621	50	280	107	45	22	20	5
YT-1622	55	310	118	55	25	22	5

1

- EN Half-moon spanner
- PL Klucz oczkowy typu „C”
- DE Starter- und Blockschlüssel
- RU Ключ накладной изогнутый „С”
- CZ Klíč očkoplochý typ „C”
- HU Félhold alakú csillagkulcs
- RO Cheie inelara semi-luna
- FR Clé à oeil „C”
- IT Chiave poligonale doppio speciale tipo „C”
- ES Llave de estrella tipo „C”
- CN C型梅花扳手

CrV 6140 AS-DRIVE

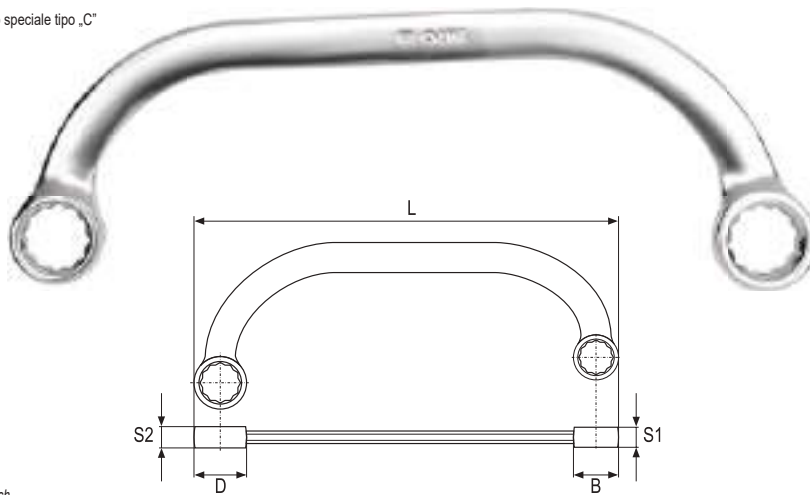

- Application: industry
- Excellent for work in tight spaces
- Used for dismantling of collector tubes, alternators and starters
- Surface finish: chromed, satin
- Przeznaczenie: przemysł
- Do pracy w miejscach szczególnie trudno dostępnych
- Ułatwia odkręcanie kolektorów, alternatorów i rozruszników samochodowych
- Wykończenie powierzchni: chromowana, satynowa

YATO	Ø [mm]	L [mm]	B [mm]	D [mm]	S1 [mm]	S2 [mm]	PCS
YT-0170	10x12	145	16.8	19.2	6.8	6.8	10/60
YT-0171	11x13	170	18.5	21.2	8.4	8.6	10/60
YT-0172	14x15	195	22.8	25.8	9.2	9.9	10/60

YATO	Ø [mm]	L [mm]	B [mm]	D [mm]	S1 [mm]	S2 [mm]	PCS
YT-0173	16x17	220	26.2	28.6	9.9	10.5	10/60
YT-0175	19x22	260	28.7	32.9	10.4	10.9	10/60

- EN Flare nut wrench
- PL Klucz oczkowy półotwarty
- DE Schraubenschlüssel, halboffen
- RU Ключ накладной полуоткрытый
- CZ Klíč prstencový polootevřený
- HU Csuklós, nyitott
- RO Cheie inelară semideschisă
- FR Clé mixte à cliquet
- IT Chiave poligonale semiaperto
- ES Llave semiabierta
- CN 油管扳手

CrV 6140

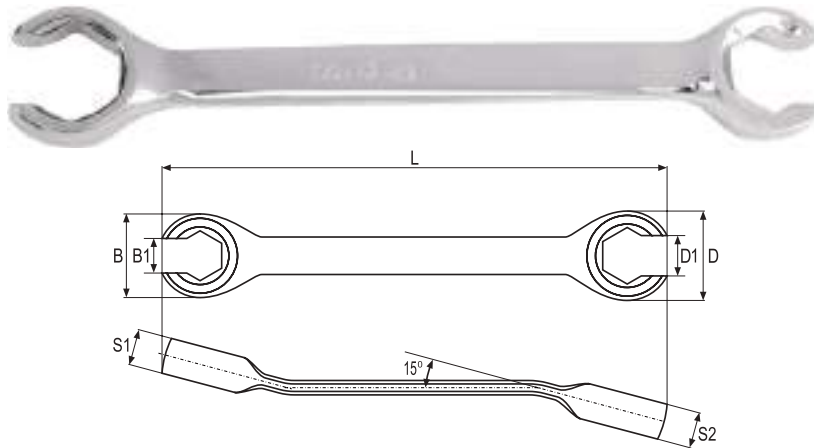

YATO	Ø [mm]	L [mm]	B [mm]	B1 [mm]	D [mm]	D1 [mm]	S1 [mm]	S2 [mm]	PCS	PCS
YT-0135	8x10	140	18.7	6.2	21.8	7.2	7.7	8.4	10	200/400
YT-0136	11x12	160	21.2	8.1	24.0	9.2	8.5	9.5	10	100/200
YT-0137	13x14	175	26.3	9.6	27.3	10.7	9.6	10.5	10	100/200
YT-0138	15x17	190	31.2	11.8	31.2	13.0	11.5	10.9	10	50/100

YATO	Ø [mm]	L [mm]	B [mm]	B1 [mm]	D [mm]	D1 [mm]	S1 [mm]	S2 [mm]	PCS	PCS
YT-01385	17x19	195	29.0	14.5	31.2	15.0	12.4	12.8	10	50/100
YT-0139	19x21	230	36.3	14.7	42.1	16.7	12.4	12.8	10	50/100
YT-0140	22x24	250	42.7	17.1	44.2	18.6	13.2	13.9	10	50/100

- EN Flare nut wrench set
- PL Zestaw kluczy oczkowych półotwartych
- DE Schraubenschlüssel, halboffen
- RU Набор накладных полуоткрытых
- CZ Klíč prstencový polootevřený
- HU Csuklós, nyitott
- RO Cheie inelară semideschisă
- FR Set de clés à tête fendue
- IT Set chiavi poligonali semiaperte
- ES Llaves semiabierta
- CN 油管扳手组套

4 PCS CrV 6140



YATO	Ø [mm]	PCS
YT-0143	8x10, 11x12, 13x14, 15x17	25/50

- EN Torx ring spanner set
- PL Komplet kluczy oczkowych Torx
- DE Torx-Ringschlüsselsatz
- RU Набор накладных ключей
- CZ Očkové klíče
- HU Csillagkulcs készlet
- RO Chei inelare
- FR Set de clés à oeil
- IT Set chiavi doppie Torx
- ES Llaves de anillo Torx
- CN 星型扳手组套

4 PCS CrV 6150



YATO	Ø [mm]	PCS
YT-0530	E6xE8, E10xE12, E14xE18, E20xE24	10/60

EN Torx type double head flexible wrench
PL Klucz przegubowy Torx
DE Torx Doppel-Gelenkschlüssel
RU Ключ двусторонний шарнирный Torx
CZ Oboustranný kloubový klíč Torx
HU Csavarkulcs Torx

RO Cheie Torx cu articulație
FR Clé articulée Torx
IT Chiave snodata Torx
ES Llave articulada Torx
CN 双摇头杆

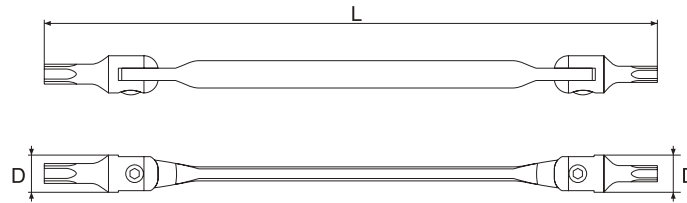

YATO	⊕	L [mm]	D [mm]	📦
YT-05311	T15xT20	202	12.4	25/100
YT-05312	T25xT27	216	13.9	25/100
YT-05313	T30xT40	229	17.8	25/100
YT-05314	T45xT50	243	19.7	10/50
YT-05315	T55xT60	255	21.8	10/50

EN Torx type double head flexible wrench set
PL Zestaw kluczy Torx z przegubem
DE Torx Doppel-Gelenkschlüssel-Satz
RU Набор ключей Torx с шарниром
CZ Klíče kloubové zástrčné Torx sada
HU Kétféjű Torx flexibilis szárral készlet
RO Set chei Torx cu articulație
FR Clé à double tête de type Torx
IT Set di chiavi snodate Torx
ES Juego de llaves articuladas Torx
CN 双摇头杆

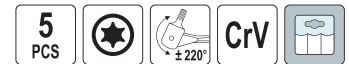

YATO	⊕	📦
YT-05320	T15xT20, T25xT27, T30xT40, T45xT50, T55xT60	20

EN L-type socket wrench
PL Klucz nasadowy typu „L”
DE Steckschlüssel gebogen
RU Ключ торцевой „L” типа
CZ Nástrčný klíč fajtkový
HU Kulcs, dugó-pipa
RO Cheie tubulara cu cot tip „L”
FR Clé en „L”
IT Chiave a tubo doppio tipo „L”
ES Llave de vaso „L”
CN L 型套筒扳手

CrV
6140

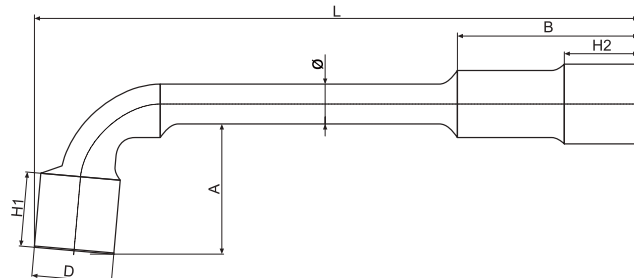

YATO	⊕ [mm]	L [mm]	B [mm]	H1 [mm]	H2 [mm]	A [mm]	D [mm]	Ø [mm]	📦
YT-1627	7	106	27.0	10.1	10.2	21.0	10.7	7	12/60
YT-1628	8	117	29.5	11.9	12.3	18.5	12.2	9	12/60
YT-1629	9	121	31.7	12.8	13.4	19.1	13.2	10	12/60
YT-1630	10	131	35.1	16.9	16.4	23.3	15.0	10	12/60
YT-1631	11	138	36.0	16.8	16.5	24.7	16.3	11	12/60
YT-1632	12	147	42.5	18.2	17.9	17.9	18.0	12	12/60
YT-1633	13	154	44.2	19.1	18.5	30.1	19.3	12	12/60
YT-1634	14	162	47.0	20.3	19.3	30.2	20.8	13	12/60
YT-1635	15	173	48.9	21.6	20.6	31.6	22.3	13	12/60
YT-1636	16	182	55.0	23.1	23.2	37.3	23.6	14	12/60

YATO	⊕ [mm]	L [mm]	B [mm]	H1 [mm]	H2 [mm]	A [mm]	D [mm]	Ø [mm]	📦
YT-1637	17	188	57.0	25.5	25.1	37.9	25.1	14	12/36
YT-1638	18	192	57.1	24.6	25.1	40.1	26.0	14	12/36
YT-1639	19	207	62.3	27.4	26.9	41.6	28.2	16	12/36
YT-1640	20	215	62.4	28.3	27.0	42.4	29.2	16	6/24
YT-1641	21	221	65.0	30.6	30.5	54.0	30.2	16	6/24
YT-1642	22	232	67.5	30.6	30.8	49.1	31.7	16	6/24
YT-1644	24	253	78.2	31.7	32.3	53.5	33.6	17	6/18
YT-1647	27	288	85.3	36.4	36.9	54.7	37.6	20	6/12
YT-1649	30	310	95.0	38.6	38.4	65.3	42.0	22	6/12

1

- EN Ratchet wrench
- PL Klucz nasadkowy z grzechotką
- DE Gerüstratsche
- RU Ключ торцовый с трещоткой
- CZ Ráčnový klič průchozí
- HU Kettős racsnis kulcs
- RO Cheie tubulara cu clichet
- FR Clé à tube à cliquet
- IT Chiavi a cricchetto per ponteggi
- ES Llave de vaso con carraca
- CN 尖尾棘轮扳手

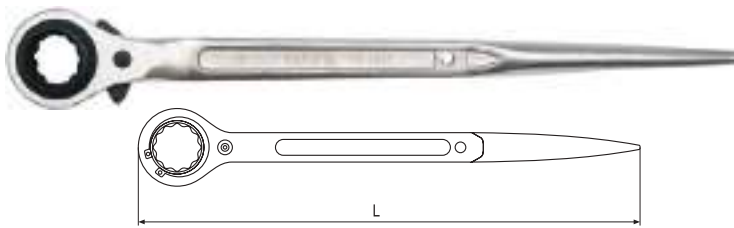

19x22 mm
32T
CrV
COLD FORGED KUTE NA ZIMNO

YATO	Ø [mm]	L [mm]	
YT-4937	19x22	315	2/40

- EN Double ratchet wrench
- PL Dwustronny klucz nasadkowy z grzechotką
- DE Gerüstratsche
- RU Ключ торцовый с трещоткой
- CZ Ráčnový klič průchozí dvoustranný
- HU Kettős racsnis kulcs
- RO Cheie tubulara dubla cu clichet
- FR Clé à oeil à cliquet
- IT Chiave a cricco doppio
- ES Llave de vaso con carraca
- CN 尖尾棘轮扳手

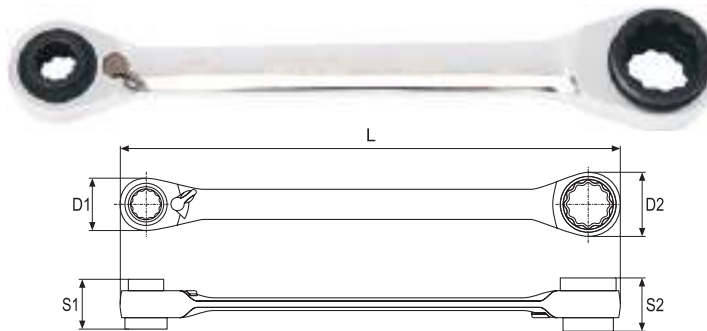

10x13 mm
17x19 mm
72T
CrV

YATO	Ø [mm]	L [mm]	D1 [mm]	D2 [mm]	S1 [mm]	S2 [mm]	
YT-4945	10x13x17x19	200	29	35	17	22	5/50

- EN Socket wrench with handle
- PL Klucz nasadowy z rękojeścią
- DE Steckschlüssel
- RU Ключ торцевой
- CZ Nástrčný klič
- HU Kulcs
- RO Cheie tubulara
- FR Clé à tube
- IT Chiave a cricco doppio
- ES Llave
- CN 六角套筒螺丝批



HRC 44
CrV

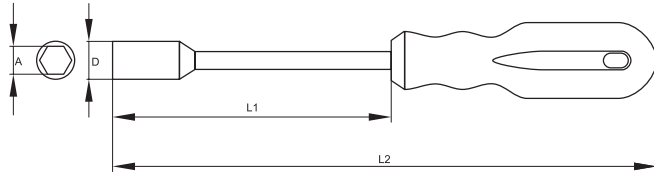

YATO	Ø [mm]	D [mm]	L1 [mm]	L2 [mm]	PCS PERE	
YT-1542	6	9.1	125	242	6	120
YT-1543	7	10.9	125	242	6	120
YT-1544	8	12.0	125	242	6	120
YT-1546	10	14.1	125	242	6	120
YT-1549	13	18.0	125	242	6	120

- EN T-type deep socket wrench with rotary handle
- PL Klucz nasadowy typu „T” z obrotową rękojeścią
- DE Steckschlüssel vom Typ „T” mit drehbarem Handgriff
- RU Торцовый ключ типа „Т” с вращательной ручкой
- CZ Klič nástrčný typ „T” s otočnou rukojetí
- HU „T” típusú dugókulcs, forgatható karral

- RO Cheie tubulară de tip „T” cu mâner rotativ
- FR Clé à tube en „T”
- IT Chiave tipo „T” con manico scorrevole
- ES Llave tubular „T” con un mango giratorio
- CN T型套筒扳手

CrV 6140
AS-DRIVE

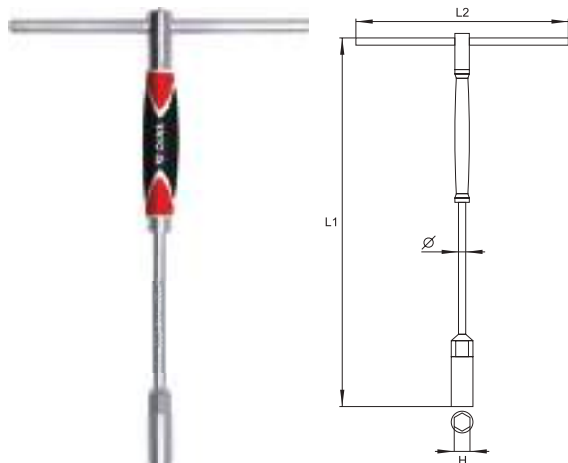

- Ergonomic handle
- Movable handle with position locking system
- Long bar for work in deeply set, difficult to reach places
- Ergonomiczna rękojeść
- Przesuwane pokrętko z blokadą położenia
- Długi trzpień umożliwiający pracę w głębokich wnękach



YATO	Ø [mm]	L1 [mm]	L2 [mm]	Ø [mm]	
YT-1552	8	310	200	10	10/40
YT-1554	10	310	200	10	10/40
YT-1556	12	310	200	10	10/40
YT-1557	13	310	200	10	10/40
YT-1558	14	310	200	10	10/40

- EN T-type adapter with rotary handle
- PL Adapter typu „T” z obrotową rękojeścią
- DE Adapter vom Typ „T” mit drehbarem Handgriff
- RU Адаптер типа „Т” с вращательной ручкой
- CZ Adaptér typ „T” s otočnou rukojetí
- HU „T” típusú adapter, forgatható karral

- RO Adaptor tip „T” cu mâner rotativ
- FR Adapteur en „T”
- IT Adattatore tipo „T” con manico scorrevole
- ES Adaptador „T” con un mango giratorio
- CN T型套筒接头

1/4" 6.3 mm
3/8" 9.5 mm
1/2" 12.7 mm
CrV 6140

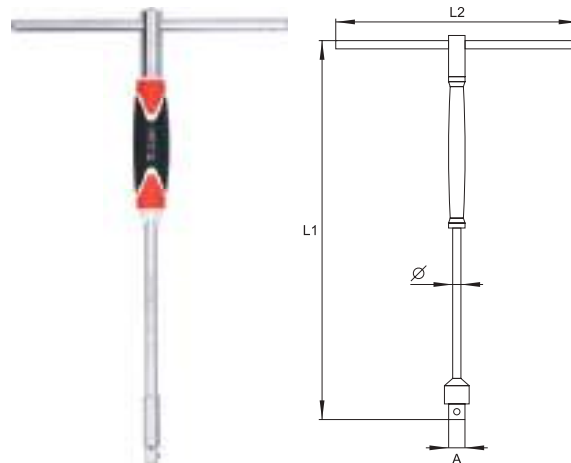

- Ergonomic handle
- Movable handle with position locking system
- Long bar for work in deeply set, difficult to reach places
- Ergonomiczna rękojeść
- Przesuwane pokrętko z blokadą położenia
- Długi trzpień umożliwiający pracę w głębokich wnękach



YATO	Ø H	L1 [mm]	L2 [mm]	Ø [mm]	
YT-1565	1/4" (6.3 mm)	310	200	8	10/40
YT-1566	3/8" (9.5 mm)	310	200	10	10/40
YT-1567	1/2" (12.7 mm)	310	200	10	10/40

EN T-type deep socket wrench
PL Klucz nasadowy typu „T”
DE Steckschlüssel vom Typ „T”
RU Торцовый ключ типа „T”
CZ Klíč nástrčný typ „T”
HU „T” típusú dugókulcs

RO Cheie tubulară de tip „T”
FR Clé à tube en „T”
IT Chiave a bussola tipo „T”
ES Llave tubular „T”
CN T型套筒扳手

CrV
6140

AS-DRIVE

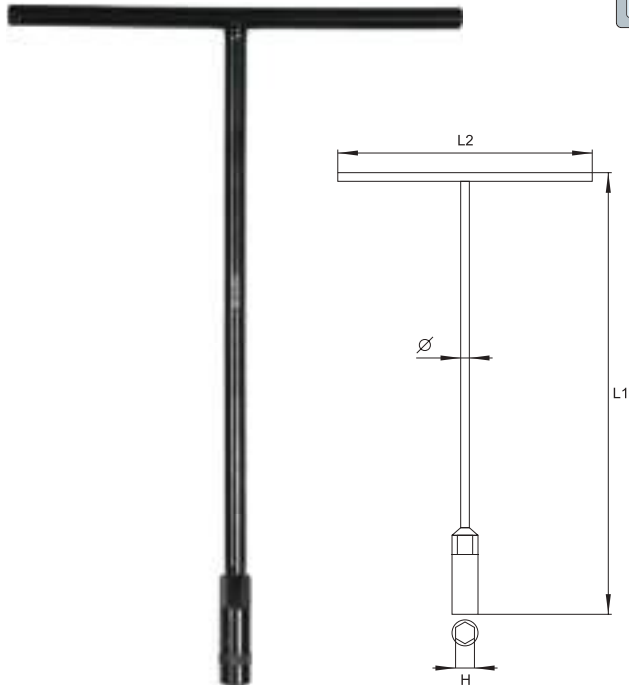

YATO	Ø [mm]	L1 [mm]	L2 [mm]	Ø [mm]	
YT-1571	8	310	200	10	10/40
YT-1573	10	310	200	10	10/40
YT-1575	12	310	200	10	10/40
YT-1576	13	310	200	10	10/40

EN T-handle swivel socket wrench
PL Klucz nasadowy z przegubem typu „T”
DE T-Griff Steckchlüssel mit Gelenk
RU Ключ торцевой с карданом Т-образный
CZ Hlavice ohebná na T-rukojeji matlu povrch
HU Csuklós „T” kulcs adatai
RO Cheie tubulară cu cruce cardanica tip „T”
FR Clé à poignée en „T” longue à cardan
IT Chiave a bussola a „T” con snodo
ES Llave vaso en „T” con cardan
CN T型活动套筒扳手



CrV
50BV30

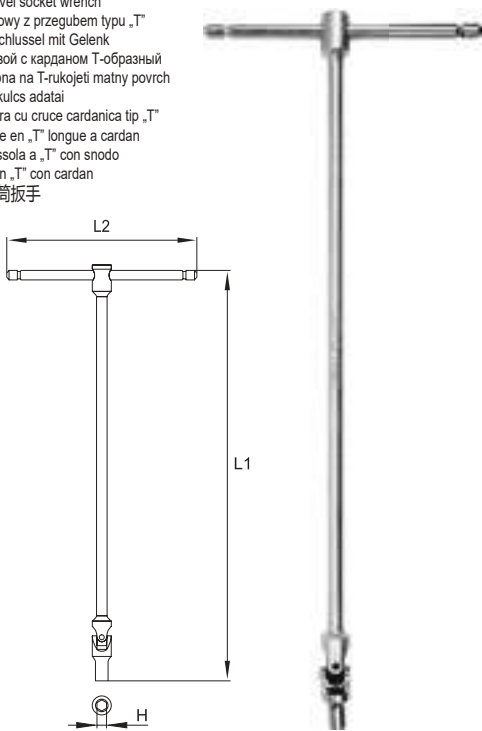

YATO	Ø [mm]	L1 [mm]	L2 [mm]	
YT-15273	8	450	180	10/40
YT-15275	10	450	180	10/40
YT-15277	12	450	180	10/40
YT-15278	13	450	180	10/40
YT-15279	14	450	180	10/40
YT-15280	15	450	180	10/40
YT-15282	17	450	180	10/40

EN T-type deep socket wrench set
PL Zestaw kluczy nasadowych typu „T”
DE Steckschlüsselsatz vom Typ „T”
RU Набор торцевых ключей типа „T”
CZ Sada nástrčných klíčů typ „T”
HU „T” típusú dugókulcs készlet

RO Set chei tubulare de tip „T”
FR Ensemble de clé à douille de type „T”
IT Set di chiavi a bussola a „T”
ES Juego de llaves tubulares „T”
CN T型套筒扳手套

CrV
6140

AS-DRIVE



YATO	Ø [mm]	
YT-15791	8, 10, 13	4/16

EN T-handle swivel adapter
PL Klucz z przegubem typu „T”
DE T-Griff Steckchlüssel mit Gelenk
RU Вороток Т-образный с карданом
CZ „T” klíč sa kloubem
HU Csuklós T-hajtószer
RO Adaptor tip „T” cu cruce cardanica
FR Clé à poignée en „T” longue à cardan
IT Chiave a „T” con snodo
ES Alargadera a cardan
CN T型活动套筒扳手



CrV
50BV30

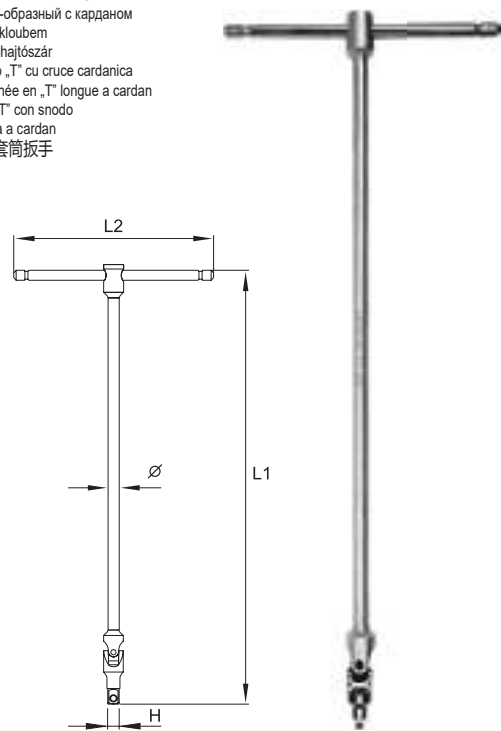



YATO	Ø H	L1 [mm]	L2 [mm]	
YT-15291	1/4" (6.3 mm)	450	180	10/40
YT-15292	3/8" (9.5 mm)	450	180	10/40
YT-15293	1/2" (12.7 mm)	450	180	10/40

EN Adjustable wrench
PL Klucz nastawny
DE Rollgabelschlüssel
RU Ключ разводной

CZ Nastavitelný klíč
HU Állítható svédkulcs
RO Cheie reglabilă
FR Clé à molette



IT Chiave a rullino graduata
ES Llave ajustable tipo inglesa
CN 发黑活络扳手



YATO 	L [mm]	
YT-2071	150	6/60
YT-2072	200	6/60
YT-2073	250	6/36
YT-2074	300	6/24
YT-2075	375	6/12





DIN 3117 

YATO 	L [mm]	
YT-2170	150	6/72
YT-2171	200	6/60
YT-2172	250	6/48
YT-2173	300	6/36



DIN 3117 

YATO 	L [mm]	Max. jaws range / Maks. rozwarcie szczęk [mm]	
YT-21650	150	19.3	6/60
YT-21651	200	24.0	6/60
YT-21652	250	30.0	6/36
YT-21653	300	36.0	6/24
YT-21654	375	45.0	2/16

EN Flexible hook wrench
PL Klucz hakowy
DE Hakenschlüssel



RU Ключ сегментный шарнирный
CZ Hákový klíč
HU Körmös kulcs

RO Cheie universală cu carlig
FR Clé à crochet
IT Chiave a settore



ES Llave de gancho articulada
CN 方头钩型扳手

CrV 



YATO 	L [mm]	⌀ [mm]	
YT-01670	170	15-35	10/50
YT-01671	210	35-50	10/50
YT-01672	280	50-80	10/50
YT-01673	340	80-120	5/10
YT-01674	470	120-180	5/10



YATO 	L [mm]	⌀ [mm]	
YT-01675	170	15-35	10/50
YT-01676	210	35-50	10/50
YT-01677	280	50-80	10/50
YT-01678	340	80-120	5/10
YT-01679	470	120-180	5/10



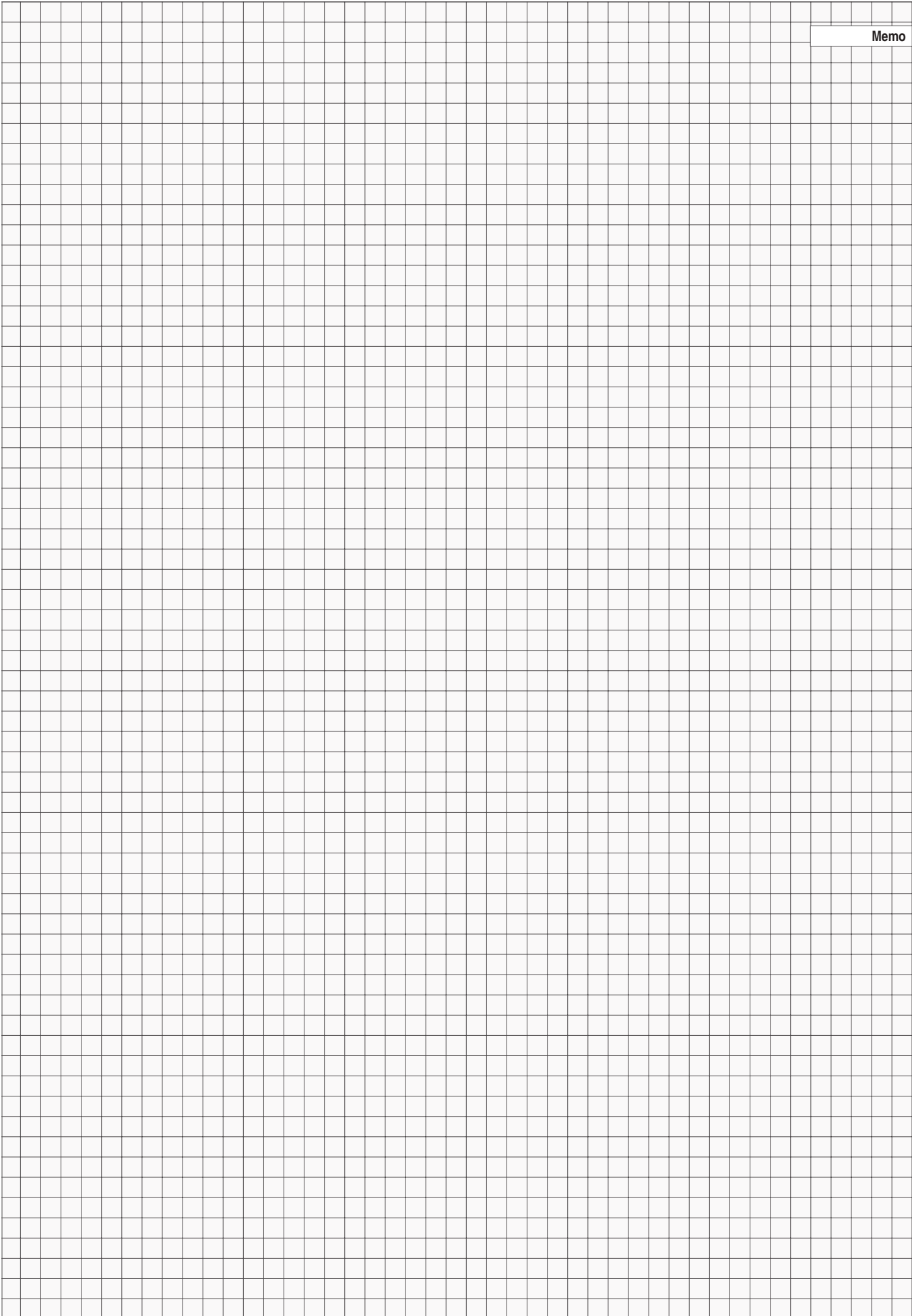





Memo











2

Sockets, accessories & sets
Klucze nasadowe,
akcesoria i zestawy



Sockets 1/4" Klucze nasadowe 1/4"			Sliding T-bars Pokrętła typu „T”..... 28
..... 23			Flexible handles Pokrętła łamane..... 28
Hexagonal sockets Klucze nasadowe sześciokątne, krótkie..... 23			Ratchet handles 3/8" Grzechotki 3/8"
Hexagonal deep sockets Klucze nasadowe sześciokątne, długie..... 23		 29 
Accessories 1/4" Akcesoria 1/4"			Ratchet handles Grzechotki..... 29
..... 23-25			Flexible ratchet handles Grzechotki z przegubem..... 29
Extension bars Przedłużki..... 23			Composite ratchet handles Grzechotki powlekane..... 29
Extension bars with wobble Przedłużki uchyłne..... 24			Curved ratchet handles Grzechotki wygięte..... 29
Adapters Redukcje..... 24			Telescopic ratchet handles Grzechotki z przedłużonym uchwytem..... 29
Bit adapters Adaptory do bitów..... 24			Sockets 1/2" Klucze nasadowe 1/2"
Universal joints Przeguby Cardana..... 24		 30-31 
Spinner handles Pokrętła do nasadek..... 24			Hexagonal sockets Klucze nasadowe sześciokątne, krótkie..... 30
Sliding T-bars Pokrętła typu „T”..... 25			Bi-hexagonal sockets Klucze nasadowe dwunastokątne, krótkie..... 30
Flexible handles Pokrętła łamane..... 25			Spline sockets Klucze nasadowe „Spline”..... 30
Ratchet handles 1/4" Grzechotki 1/4"			Hexagonal deep sockets Klucze nasadowe sześciokątne, długie..... 31
..... 25-26			Bi-hexagonal deep sockets Klucze nasadowe dwunastokątne, długie..... 31
Ratchet handles Grzechotki..... 25			Accessories 1/2" Akcesoria 1/2"
Flexible ratchet handles Grzechotki z przegubem..... 25		 31-32 
Composite ratchet handles Grzechotki powlekane..... 26			Extension bars Przedłużki..... 31
Curved ratchet handles Grzechotki wygięte..... 26			Extension bars with wobble Przedłużki uchyłne..... 31
Telescopic ratchet handles Grzechotki z przedłużonym uchwytem..... 26			Adapters Redukcje..... 31
Bit and socket drive ratchet handles Grzechotki do bitów i nasadek..... 26			Bit adapters Adaptory do bitów..... 32
Sockets 3/8" Klucze nasadowe 3/8"			Universal joints Przeguby Cardana..... 32
..... 27			Sliding T-bars Pokrętła typu „T”..... 32
Hexagonal sockets Klucze nasadowe sześciokątne, krótkie..... 27			Flexible handles Pokrętła łamane..... 32
Hexagonal deep sockets Klucze nasadowe sześciokątne, długie..... 27			L-type handles Pokrętła typu „L”..... 32
Accessories 3/8" Akcesoria 3/8"			Ratchet handles 1/2" Grzechotki 1/2"
..... 27-28		 33 
Extension bars Przedłużki..... 27			Ratchet handles Grzechotki..... 33
Extension bars with wobble Przedłużki uchyłne..... 27			Flexible ratchet handles Grzechotki z przegubem..... 33
Adapters Redukcje..... 28			Composite ratchet handles Grzechotki powlekane..... 33
Bit adapters Adaptory do bitów..... 28			Curved ratchet handles Grzechotki wygięte..... 33
Universal joints Przeguby Cardana..... 28			Telescopic ratchet handles Grzechotki z przedłużonym uchwytem..... 33



<p>Socket sets Zestawy kluczy nasadowych</p> <p>34-47 </p>	<p>Sockets 3/4" Klucze nasadowe 3/4"</p> <p>50 </p>
<p>Socket sets 1/4" Zestawy kluczy nasadowych 1/4"..... 34</p> <p>Socket sets 3/8" Zestawy kluczy nasadowych 3/8"..... 35</p> <p>Socket sets 1/2" Zestawy kluczy nasadowych 1/2"..... 36</p> <p>Socket sets 1/2", 1/4" Zestawy kluczy nasadowych 1/2", 1/4"..... 37</p> <p>Socket sets 1/2", 3/8", 1/4" Zestawy kluczy nasadowych 1/2", 3/8", 1/4"..... 41</p>	<p>Accessories 3/4" Akcesoria 3/4"..... 51-52 </p> <p>Extension bars Przedłużki..... 51</p> <p>Adapters Redukcje..... 51</p> <p>Universal joints Przeguby Cardana..... 51</p> <p>Sliding T-bars Pokręta typu „T”..... 51</p> <p>Flexible handles Pokręta łamane..... 51</p> <p>L-type handles Pokręta typu „L”..... 52</p>
<p>Socket sets Zestawy kluczy nasadowych</p> <p>48 </p>	<p>Ratchet handles 3/4" Grzechotki 3/4"..... 52 </p>
<p>Socket sets 1/4" Zestawy kluczy nasadowych 1/4"..... 48</p> <p>Socket sets 1/2" Zestawy kluczy nasadowych 1/2"..... 48</p> <p>Socket sets 1/2", 3/8" Zestawy kluczy nasadowych 1/2", 3/8"..... 48</p>	<p>Socket sets 3/4" Zestawy kluczy nasadowych 3/4"..... 52 </p>
<p>Tool sets Zestawy narzędziowe</p> <p>49 </p>	<p>Bit sockets & sets 1/4", 3/8", 1/2" Klucze trzpieniowe i zestawy 1/4", 3/8", 1/2"..... 53-58 </p>
<p>Torx sockets & sets Klucze nasadowe „Torx” i zestawy</p> <p>49-50 </p>	

EN Hexagonal socket
PL Nasadka sześciokątna
DE Sechskantenschlüssel
RU Головка шестигранная короткая
CZ Šestihranný nástavec
HU Dugókulcs hatszög
RO Cheie tubulară hexagonală
FR Douille courte
IT Chiave a bussola esagonale
ES Boquilla hexagonal corta
CN 六角套筒

1/4"
6.3mm
DIN 3121
CrV 50BV30
AS-DRIVE

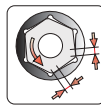
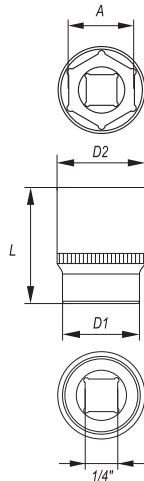

- Drive locks
- Surface finish: chromed, satin / mirror
- Zamki blokujące
- Wykończenie powierzchni: chromowana, satynowa / polerowana

YATO	o A [mm]	D1 [mm]	D2 [mm]	L [mm]	PCS PCORE	
YT-1401	4.0	7.0	12	25	24	240/480
YT-1403	5.0	8.0	12	25	24	240/480
YT-1404	5.5	8.5	12	25	24	240/480
YT-1405	6.0	9.0	12	25	24	240/480
YT-1406	7.0	10.0	12	25	24	240/480
YT-1407	8.0	12.0	11	25	24	240/480
YT-1408	9.0	13.0	12	25	24	240/480
YT-1409	10.0	15.0	12	25	24	240/480
YT-1410	11.0	16.0	14	25	24	240/480
YT-1411	12.0	17.0	15	25	24	240/480
YT-1412	13.0	18.0	16	25	24	240/480

EN Hexagonal deep socket
PL Nasadka sześciokątna długa
DE Sechskantenschlüssel, lange
RU Головка шестигранная длинная
CZ Šestihranný hluboký nástavec
HU Dugókulcs hatszög hosszú
RO Cheie tubulară hexagonală adâncă
FR Douille longue
IT Chiave a bussola esagonale
ES Boquilla hexagonal larga
CN 六角长套筒

1/4"
6.3mm
DIN 3121
CrV 50BV30
AS-DRIVE

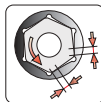
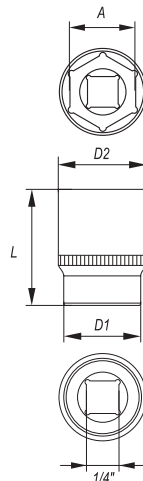

- Drive locks
- Surface finish: chromed, satin / mirror
- Zamki blokujące
- Wykończenie powierzchni: chromowana, satynowa / polerowana

YATO	o A [mm]	D1 [mm]	D2 [mm]	L [mm]	PCS PCORE	
YT-1413	4.0	7.0	12	50	24	240/480
YT-1414	4.5	7.5	12	50	24	240/480
YT-1415	5.0	8.0	12	50	24	240/480
YT-1416	5.5	8.5	12	50	24	240/480
YT-1417	6.0	9.0	12	50	24	240/480
YT-1418	7.0	10.0	12	50	24	240/480
YT-1419	8.0	12.0	12	50	24	240/480
YT-1420	9.0	13.0	12	50	24	240/480
YT-1421	10.0	14.0	13	50	24	240/480
YT-1422	11.0	16.0	14	50	24	120/240
YT-1423	12.0	17.0	15	50	24	120/240
YT-1424	13.0	18.0	16	50	24	120/240

EN Hexagonal socket
PL Nasadka sześciokątna
DE Sechskantenschlüssel
RU Головка шестигранная короткая
CZ Šestihranný nástavec
HU Dugókulcs hatszög
RO Cheie tubulară hexagonală
FR Douille courte
IT Chiave a bussola esagonale
ES Boquilla hexagonal corta
CN 六角套筒

1/4"
6.3mm
CrV 50BV30
AS-DRIVE

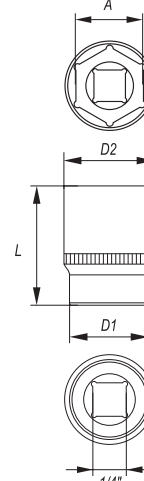

YATO	o A [mm]	D1 [mm]	D2 [mm]	L [mm]	
YT-14120	5.0	8.0	12	25	12/360
YT-14121	5.5	8.5	12	25	12/360
YT-14123	6.0	9.0	12	25	12/360
YT-14124	7.0	10.0	12	25	12/360
YT-14125	8.0	12.0	12	25	6/360
YT-14126	9.0	13.0	12	25	6/360
YT-14127	10.0	15.0	12	25	6/360
YT-14128	12.0	17.0	15	25	6/360
YT-14129	13.0	18.0	16	25	6/360

EN Extension bar
PL Przedłużka
DE Verlängerung
RU Удлинитель для воротка
CZ Prodlužovací příravek
HU Toldalék
RO Prelungitor
FR Rallonge
IT Prolunga
ES Tubo de prolongación
CN 接杆

1/4"
6.3mm
DIN 3121
CrV 50BV30

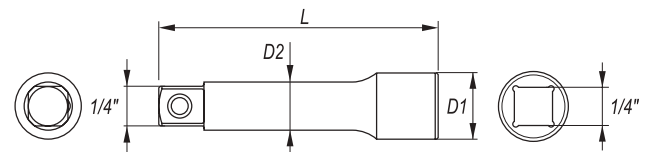

YATO	o	D1 [mm]	D2 [mm]	L [mm]	PCS PCORE	
YT-1429	1/4" (6.3 mm)	12.4	8.3	50.8	30	150/300
YT-1430	1/4" (6.3 mm)	12.4	8.3	76.0	30	150/300
YT-1431	1/4" (6.3 mm)	12.4	8.3	101.6	20	100/200
YT-1432	1/4" (6.3 mm)	12.4	8.3	152.4	20	100/200

- EN Extension bar with wobble
 PL Przedłużka uchylna
 DE Gelenkverlängerung
 RU Удлинитель наклонный
 CZ Odchýlný prodlužovací přípravek
 HU Csuklós toldalék
- RO Prelungitor rabatabil
 FR Rallonge angulaire
 IT Prolunga
 ES Tubo de prolongación desviable
 CN 转向接杆

1/4"
6.3mm

DIN
3121

CrV
50BV30

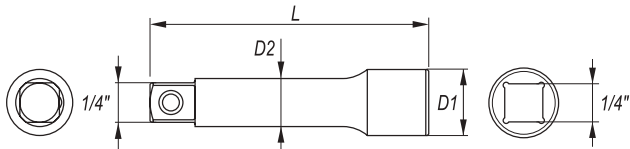



YATO	Ø	D1 [mm]	D2 [mm]	L [mm]	PCS PKG	Icon
YT-1433	1/4" (6.3 mm)	12.4	8.3	50.8	30	150/300
YT-1434	1/4" (6.3 mm)	12.4	8.3	76.0	30	150/300
YT-1435	1/4" (6.3 mm)	12.4	8.3	101.6	20	100/200
YT-1436	1/4" (6.3 mm)	12.4	8.3	152.4	20	100/200

- EN Bit adapter
 PL Adapter do bitów
 DE Bithalter
 RU Держатель винтовёртовых наконечников
 CZ Držák na šroubovakové koncovky
 HU Szár a csavarhúzóvégéhez
 RO Capete şurubelniţă
 FR Adaptateur d'embouts
 IT Chiave esagonale a bussola
 ES Mandril para puntas
 CN 旋具头接头

1/4"
6.3mm

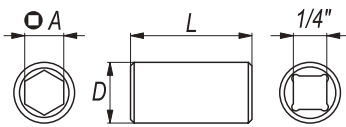
CrV
6140

YATO	Ø	Ø A	D [mm]	L [mm]	PCS PKG	Icon
YT-12971	1/4" (6.3 mm)	1/4" (6.3 mm)	11.8	24	5/600	

- EN Universal joint
 PL Przegub Cardana
 DE Kardangelenk
 RU Карданный шарнир
 CZ Kardánový kloub
 HU Kardán csukló
- RO Articulație Cardanică
 FR Cardan
 IT Snodo cardanico
 ES Articulación Cardan
 CN 万向接头

1/4"
6.3mm

DIN
3121

CrV
50BV30

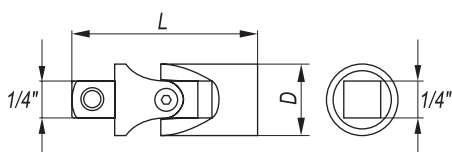
YATO	Ø	D [mm]	L [mm]	PCS PKG	Icon
YT-1437	1/4" (6.3 mm)	14	35	20	120/240

- EN Adapter
 PL Redukcja
 DE Reduktion
 RU Переходник
 CZ Redukce
 HU Redukció
- RO Reducție
 FR Réduction
 IT Riduttore
 ES Reducción
 CN 转换头

1/4"
6.3mm

DIN
3121

CrV
50BV30

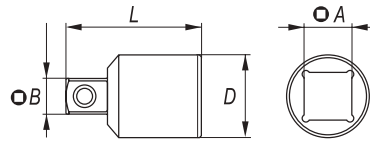
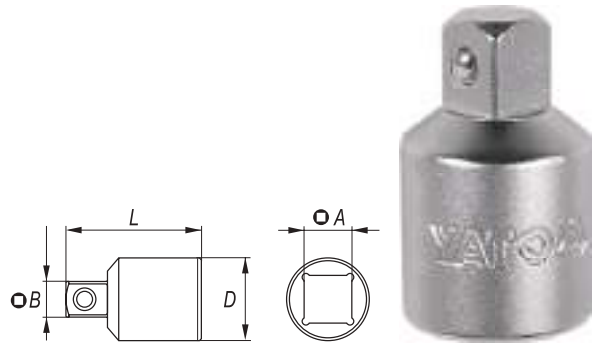



YATO	Ø A	Ø B	D [mm]	L [mm]	PCS PKG	Icon
YT-1438	1/4" (6.3 mm) (F)	3/8" (9.5 mm) (M)	12	25	10	250/500

- EN Bit adapter
 PL Adapter do bitów
 DE Bithalter
 RU Держатель винтовёртовых наконечников
 CZ Držák na šroubovakové koncovky
 HU Szár a csavarhúzóvégéhez
 RO Capete şurubelniţă
 FR Adaptateur d'embouts
 IT Chiave esagonale a bussola
 ES Mandril para puntas
 CN 旋具头接头

1/4"
6.3mm

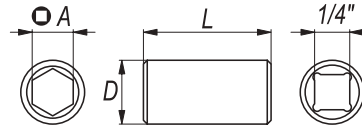
CrV
6140

YATO	Ø	Ø A	D [mm]	L [mm]	PCS PKG	Icon
YT-1297	1/4" (6.3 mm)	1/4" (6.3 mm)	11.8	24	10	250/1000

- EN Spinner handle
 PL Pokrętko do nasadek
 DE Drehgriff für Steckschlüssel
 RU Ручка с соединением под головки
 CZ Nástrčná rukojeť
 HU Csavarhúzószáj hajtószár
- RO Maner surubelnita cu antrenor
 FR Barre
 IT Porta bussola con manico
 ES Destornillador con cuadradillo
 CN 旋柄

1/4"
6.3mm

CrV
50BV30





YATO	Ø	L [mm]	PCS PKG	Icon
YT-1427	1/4" (6.3 mm)	150	12	48

EN Sliding T-bar
PL Pokrętko typu „T”
DE Handgriff mit Gleitstück
RU Вороток Т-образный
CZ Otočná ráčká typ „T”
HU „T” alakú hajtókar

RO Mâner clupă tipul „T”
FR Barre type „T”
IT Manopola „T” scorrevole
ES Mango tipo „T”
CN 滑行杆

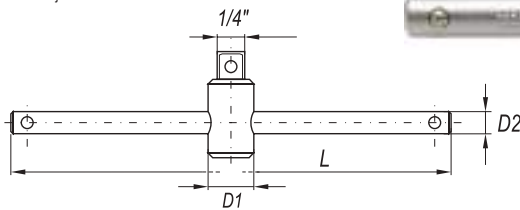
1/4"
6.3mm
DIN
3121
CrV
50BV30



YATO	Ø	D1 [mm]	D2 [mm]	L [mm]	PCS PIECE	
YT-1426	1/4" (6.3 mm)	13.3	6.3	152.4	10	100/200

EN Flexible handle
PL Pokrętko lamane
DE Gelenkgriff
RU Вороток шарнирный
CZ Otočná lomená ráčká
HU Hajlított hajtókar

RO Prelungitor cu prindere flexibilă
FR Barre pivotante
IT Manopola a snodo
ES Mango articulado
CN 转向手柄

1/4"
6.3mm
DIN
3121
CrV
50BV30

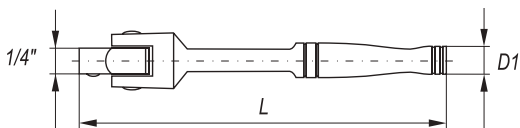

YATO	Ø	D [mm]	L [mm]	PCS PIECE	
YT-1425	1/4" (6.3 mm)	13	140	10	100/200

EN Quick release ratchet handle
PL Grzechotka
DE Hebelumschaltknarre
RU Трещотка

CZ Řehtačka
HU Racsnis hajtókar
RO Dispozitiv de prindere cu clichet
FR Clé à cliquet

IT Cricchetto bussola
ES Carraca
CN 快速脱落棘轮扳手

1/4"
6.3mm
DIN
3122
QUICK
RELEASE
SZYBKO-
ZŁĄCZE
72T



CrV
6140

YATO	Ø	T	L [mm]	PCS PIECE	
YT-0307	1/4" (6.3 mm)	72	146	12	24/96



CrV
6140

YATO	Ø	T	L [mm]	PCS PIECE	
YT-0310	1/4" (6.3 mm)	72	125	12	36/72



CrV
6140

YATO	Ø	T	L [mm]	PCS PIECE	
YT-0313	1/4" (6.3 mm)	72	125	12	24/96



CrV
6135

YATO	Ø	T	L [mm]	PCS PIECE	
YT-0316	1/4" (6.3 mm)	72	145	12	24/96



CrV
6140

YATO	Ø	T	L [mm]	PCS PIECE	
YT-0322	1/4" (6.3 mm)	72	148	12	48/96

EN Quick release ratchet handle
PL Grzechotka
DE Hebelumschaltknarre
RU Трещотка

CZ Ráčna
HU Racsnis hajtókar
RO Dispozitiv de prindere cu clichet
FR Clé à cliquet

IT Cricchetto bussola
ES Carraca
CN 快速脱落棘轮扳手

1/4"
6.3mm
DIN
3122
QUICK
RELEASE
SZYBKO-
ZŁĄCZE
72T
CrV
6140

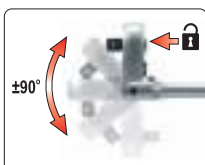

YATO	Ø	T	L [mm]	PCS PIECE	
YT-0325	1/4" (6.3 mm)	72	159	12	48/96

- EN Quick release ratchet handle
 PL Grzechotka powlekana
 DE Hebelumschaltnarre
 RU Трещотка
- CZ Řehtačka
 HU Racsnis hajtókar
 RO Dispozitiv de prindere cu clichet
 FR Clé à cliquet
- IT Cricchetto bussola
 ES Carraca
 CN 快速脱落棘轮扳手

1/4" 6.3mm
 DIN 3122
 QUICK RELEASE SZYBKO-ZŁĄCZE
 72T
 CrV 6135



YATO	Ø	T	L [mm]	PCS PCBKG	☐
YT-0290	1/4" (6.3 mm)	72	144	12	48/96

YATO	Ø	T	L [mm]	PCS PCBKG	☐
YT-0293	1/4" (6.3 mm)	72	144	12	48/96

- EN Quick release ratchet handle
 PL Grzechotka
 DE Hebelumschaltnarre
 RU Трещотка
 CZ Ráčna
 HU Racsnis hajtókar
- RO Dispozitiv de prindere cu clichet
 FR Clé à cliquet
 IT Cricchetto bussola
 ES Carraca
 CN 快速脱落棘轮扳手

1/4" 6.3mm
 QUICK RELEASE SZYBKO-ZŁĄCZE
 72T
 CrV 6140

- EN Quick release ratchet handle
 PL Grzechotka
 DE Hebelumschaltnarre
 RU Трещотка
 CZ Ráčna
 HU Racsnis hajtókar
- RO Dispozitiv de prindere cu clichet
 FR Clé à cliquet
 IT Cricchetto bussola
 ES Carraca
 CN 快速脱落棘轮扳手

1/4" 6.3mm
 QUICK RELEASE SZYBKO-ZŁĄCZE
 72T
 CrV 6135



YATO	Ø	T	L [mm]	PCS PCBKG	☐
YT-0730	1/4" (6.3 mm)	72	155	12	12/96

YATO	Ø	T	L [mm]	PCS PCBKG	☐
YT-0733	1/4" (6.3 mm)	72	155	12	24/96

- EN Telescopic ratchet handle
 PL Grzechotka z przedłużonym uchwytem
 DE Umschaltnarre
 RU Трещотка
 CZ Ráčna
 HU Racsnis hajtókar
- RO Antrenor cu clichet
 FR Clé à cliquet
 IT Cricchetto bussola
 ES Carraca telescópico
 CN 可伸缩快速脱落棘轮扳手

1/4" 6.3mm
 QUICK RELEASE SZYBKO-ZŁĄCZE
 72T
 CrV 6135



YATO	Ø	T	L [mm]	PCS PCBKG	☐
YT-0297	1/4" (6.3 mm)	72	150-200	12	12/48

- EN Ratchet handle and bit drive
 PL Grzechotka do bitów i nasadek
 DE Bit- und Steckschlüssel-Umschaltnarre
 RU Трещотка для битов и головок
 CZ Ráčna kombinovaná pro bity a nástrčné kľiče
 HU Bit és dugófej behajtó racsnis hajtókar
 RO Antrenor cu clichet pt. biti
 FR Clé à cliquet
 IT Cricchetto bussola per punte e snodi
 ES Carraca para boquillas y puntas
 CN 套筒旋具两用棘轮扳手



1/4" 6.3mm
 DIN 3122
 QUICK RELEASE SZYBKO-ZŁĄCZE
 72T
 CrV 6140

- EN Swivel ratchet handle for bits and sockets
 PL Grzechotka z obrotową głowicą do bitów i nasadek
 DE Drehkopfratsche für Bits und Steckschlüssel
 RU Трещотка для бит и головок с шарниром
 CZ Ráčna s otočnou hlavou na hlavice a bity
 HU Racsnis hajtószár bit és dugókulcshoz
 RO Antrenor clichet cu articulatie pentru tubulare și bitii
 FR Cliquet à tête pivotante pour embouts et douilles
 IT Cricchetto con testa rotante per punte e chiavi a bussola
 ES Carraca con cabeza giratoria
 CN 套筒旋具两用棘轮扳手



1/4" 6.3mm
 DIN 3122
 5°
 3D
 72T
 CrV 6140



YATO	Ø	T	L [mm]	PCS PCBKG	☐
YT-0331	1/4" (6.3 mm) x 1/4" (6.3 mm)	72	136	12	48

YATO	Ø	T	L [mm]	PCS PCBKG	☐
YT-03311	1/4" (6.3 mm) x 1/4" (6.3 mm)	72	115	10	10/100

EN Hexagonal socket
PL Nasadka sześciokątna
DE Sechskantenschlüssel
RU Головка шестигранная короткая
CZ Šestihřanný nástavec
HU Dugókulcs hatszög
RO Cheie tubulară hexagonală
FR Douille courte
IT Chiave a bussola esagonale
ES Boquilla hexagonal corta
CN 六角套筒

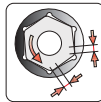
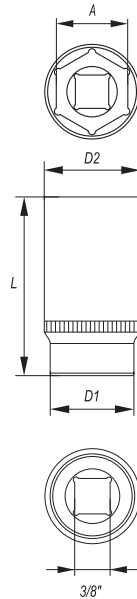

- Drive locks
- Surface finish: chromed, satin / mirror
- Zamki blokujące
- Wykończenie powierzchni: chromowana, satynowa / polerowana

YATO	∅ A [mm]	D1 [mm]	D2 [mm]	L [mm]	PCS FRONT	
YT-3801	6	10	17	28	24	240/480
YT-3802	7	11	17	28	24	240/480
YT-3803	8	12	17	28	24	240/480
YT-3804	9	13	17	28	24	240/480
YT-3805	10	14	17	28	24	240/480
YT-3806	11	16	17	28	24	240/480
YT-3807	12	18	17	28	24	240/480
YT-3808	13	19	18	28	24	240/480
YT-3809	14	20	19	28	24	240/480
YT-3810	15	21	19	28	12	240/480
YT-3811	16	22	21	28	12	240/480
YT-3812	17	24	22	30	12	120/240
YT-3813	18	25	23	30	12	120/240
YT-3814	19	26	24	30	12	120/240

EN Extension bar
PL Przedłużka
DE Verlängerung
RU Удлинитель для воротка
CZ Prodlužovací přípravek
HU Toldalék
RO Prelungitor
FR Rallonge
IT Prolunga
ES Tubo de prolongación
CN 接杆

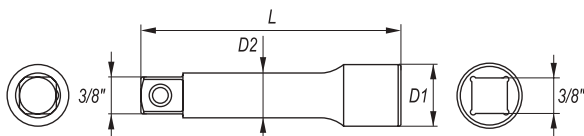

YATO	∅	D1 [mm]	D2 [mm]	L [mm]	PCS FRONT	
YT-3842	3/8" (9.5 mm)	18	12.3	42.0	10	100/200
YT-3843	3/8" (9.5 mm)	18	12.3	76.0	10	100/200
YT-3844	3/8" (9.5 mm)	18	12.3	152.4	10	50/100
YT-3845	3/8" (9.5 mm)	18	12.3	254.0	10	50

EN Hexagonal deep socket
PL Nasadka sześciokątna długa
DE Sechskantenschlüssel, lange
RU Головка шестигранная длинная
CZ Šestihřanný hluboký nástavec
HU Dugókulcs hatszög hosszú
RO Cheie tubulară hexagonală adâncă
FR Douille longue
IT Chiave a bussola esagonale
ES Boquilla hexagonal larga
CN 六角长套筒

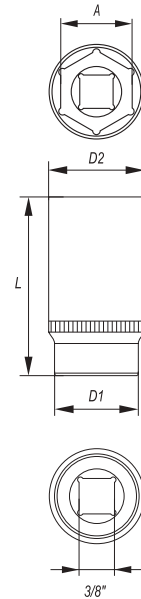

- Drive locks
- Surface finish: chromed, satin / mirror
- Zamki blokujące
- Wykończenie powierzchni: chromowana, satynowa / polerowana

YATO	∅ A [mm]	D1 [mm]	D2 [mm]	L [mm]	PCS FRONT	
YT-3820	6	10	17	63	24	48/96
YT-3821	7	10	17	63	24	48/96
YT-3822	8	12	17	63	24	48/96
YT-3823	9	13	17	63	24	48/96
YT-3824	10	14	17	63	24	48/96
YT-3825	11	16	17	63	24	48/96
YT-3826	12	18	17	63	24	48/96
YT-3827	13	19	17	63	24	48/96
YT-3828	14	20	19	63	24	48/96
YT-3829	15	21	19	63	12	60/120
YT-3830	16	22	20	63	12	60/120
YT-3831	17	24	23	63	12	60/120
YT-3832	18	25	23	63	12	60/120
YT-3833	19	26	24	63	12	60/120

EN Extension bar with wobble
PL Przedłużka uchylna
DE Gelenverlängerung
RU Удлинитель наклонный
CZ Odchylný prodlužovací přípravek
HU Csuklósdaldalék
RO Prelungitor rabatabil
FR Rallonge angulaire
IT Prolunga
ES Tubo de prolongación desviable
CN 转向接杆

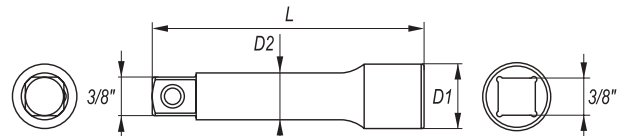
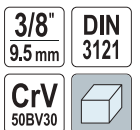

YATO	∅	D1 [mm]	D2 [mm]	L [mm]	PCS FRONT	
YT-3847	3/8" (9.5 mm)	18	12.3	76.0	10	100/200
YT-3848	3/8" (9.5 mm)	18	12.3	152.4	10	50/100
YT-3849	3/8" (9.5 mm)	18	12.3	254.0	10	50

- EN Adapter
- PL Redukcja
- DE Reduktion
- RU Переходник
- CZ Redukce
- HU Redukció
- RO Reducție
- FR Réduction
- IT Riduttore
- ES Reducción
- CN 转换头

3/8"
9.5 mm

DIN
3121

CrV
50BV30

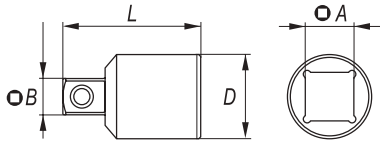



YATO	A	B	D [mm]	L [mm]	PCS PKG	
YT-3853	3/8" (9.5 mm) (F)	1/4" (6.3 mm) (M)	17	27	10	250/500
YT-3854	3/8" (9.5 mm) (F)	1/4" (6.3 mm) (M)	17	35	10	100/200

- EN Bit adapter
- PL Adapter do bitów
- DE Bithalter
- RU Держатель винтовёртовых наконечников
- CZ Držák na šroubovakové koncovky
- HU Szár a csavarhúzóvégekhez
- RO Capete şurubelniţă
- FR Adaptateur d'embouts
- IT Chiave esagonale a bussola
- ES Mandril para puntas
- CN 旋具头接头

3/8"
9.5 mm

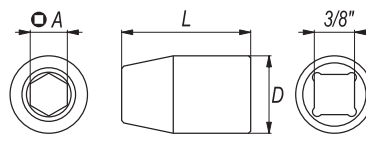
CrV
6140





YATO	A	D [mm]	L [mm]	PCS PKG	
YT-12961	3/8" (9.5 mm)	8	17.9	30	5/300

- EN Bit adapter
- PL Adapter do bitów
- DE Bithalter
- RU Держатель винтовёртовых наконечников
- CZ Držák na šroubovakové koncovky
- HU Szár a csavarhúzóvégekhez
- RO Capete şurubelniţă
- FR Adaptateur d'embouts
- IT Chiave esagonale a bussola
- ES Mandril para puntas
- CN 旋具头接头

3/8"
9.5 mm

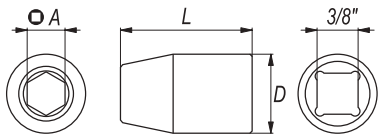
CrV
6140

YATO	A	D [mm]	L [mm]	PCS PKG		
YT-1296	3/8" (9.5 mm)	8	17.9	30	10	250/500

- EN Universal joint
- PL Przegub Cardana
- DE Kardangelenk
- RU Карданный шарнир
- CZ Kardanový kloub
- HU Kardán csukló
- RO Articulație Cardanică
- FR Cardan
- IT Snodo cardanico
- ES Articulación Cardan
- CN 万向接头

3/8"
9.5 mm

DIN
3121

CrV
50BV30

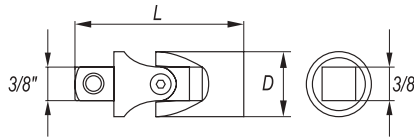
YATO	A	D [mm]	L [mm]	PCS PKG	
YT-3850	3/8" (9.5 mm)	18	49	10	50/200

- EN Sliding T-bar
- PL Pokrętko typu „T”
- DE Handgriff mit Gleitstück
- RU Вороток T-образный
- CZ Otočná račká typ „T”
- HU „T” alakú hajtókar
- RO Măner clupă tipul „T”
- FR Barre type „T”
- IT Manopola „T” scorrevole
- ES Mango tipo „T”
- CN 滑行杆

3/8"
9.5 mm

CrV
50BV30

DIN
3121

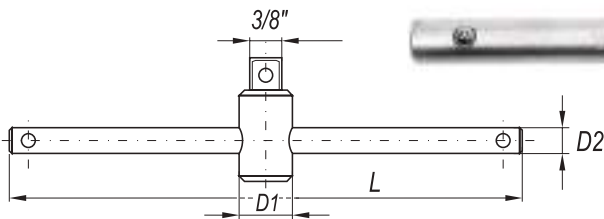
YATO	A	D1 [mm]	D2 [mm]	L [mm]	PCS PKG	
YT-3840	3/8" (9.5 mm)	20	10.7	198	10	50/100

- EN Flexible handle
- PL Pokrętko lamane
- DE Gelenkgriff
- RU Вороток шарнирный
- CZ Otočná lomená ráčka
- HU Dugókulcs hatszög hosszú
- RO Prelungitor cu prindere flexibilă
- FR Barre pivotante
- IT Manopola a snodo
- ES Mango articulado
- CN 转向手柄

3/8"
9.5 mm

DIN
3121

CrV
50BV30

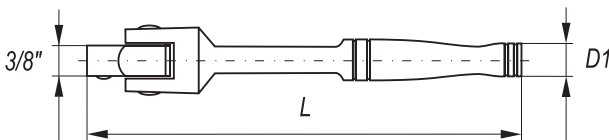
YATO	A	D [mm]	L [mm]	PCS PKG	
YT-3839	3/8" (9.5 mm)	16	215	8	24/48

EN Quick release ratchet handle
PL Grzechotka
DE Hebelumschaltknarre
RU Трещотка
CZ Řehtačka
HU Racsnis hajtókar
RO Dispozitiv de prindere cu clichet
FR Clé à cliquet
IT Cricchetto bussola
ES Carraca
CN 快速脱落棘轮扳手

3/8"
9.5 mm
DIN
3122
QUICK
RELEASE
SZYBKO-
ZŁĄCZE
72T
CrV
6140



YATO	Ø	T	L [mm]	PCS ROZB.	☐
YT-0308	3/8" (9.5 mm)	72	185	6	24/48



YATO	Ø	T	L [mm]	PCS ROZB.	☐
YT-0311	3/8" (9.5 mm)	72	200	6	18/36



YATO	Ø	T	L [mm]	PCS ROZB.	☐
YT-0314	3/8" (9.5 mm)	72	170	6	24/48



YATO	Ø	T	L [mm]	PCS ROZB.	☐
YT-0317	3/8" (9.5 mm)	72	200	6	24/48



YATO	Ø	T	L [mm]	PCS ROZB.	☐
YT-0323	3/8" (9.5 mm)	72	197	6	24/48

EN Quick release ratchet handle
PL Grzechotka
DE Hebelumschaltknarre
RU Трещотка
CZ Ráčna
HU Racsnis hajtókar
RO Dispozitiv de prindere cu clichet
FR Clé à cliquet
IT Cricchetto bussola
ES Carraca
CN 快速脱落棘轮扳手

3/8"
9.5 mm
QUICK
RELEASE
SZYBKO-
ZŁĄCZE
DIN
3122
72T
CrV
6140

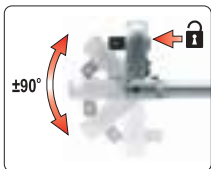

YATO	Ø	T	L [mm]	PCS ROZB.	☐
YT-0326	3/8" (9.5 mm)	72	242	6	24/48

EN Quick release ratchet handle
PL Grzechotka powlekana
DE Hebelumschaltknarre
RU Трещотка
HU Racsnis hajtókar
RO Dispozitiv de prindere cu clichet
FR Clé à cliquet
IT Cricchetto bussola
ES Carraca
CN 快速脱落棘轮扳手

3/8"
9.5 mm
DIN
3122
QUICK
RELEASE
SZYBKO-
ZŁĄCZE
72T
CrV
6135



YATO	Ø	T	L [mm]	PCS ROZB.	☐
YT-0291	3/8" (9.5 mm)	72	202	6	24/48



YATO	Ø	T	L [mm]	PCS ROZB.	☐
YT-0294	3/8" (9.5 mm)	72	202	6	24/48

EN Quick release ratchet handle
PL Grzechotka
DE Hebelumschaltknarre
RU Трещотка
CZ Ráčna
HU Racsnis hajtókar
RO Dispozitiv de prindere cu clichet
FR Clé à cliquet
IT Cricchetto bussola
CN 快速脱落棘轮扳手

3/8"
9.5 mm
72T
CrV
6140

EN Telescopic ratchet handle
PL Grzechotka z przedłużanym uchwytem
DE Umschaltknarre
RU Трещотка
CZ Ráčna
HU Racsnis hajtókar
RO Antrenor cu clichet
FR Clé à cliquet
IT Cricchetto bussola
ES Carraca telescópico
CN 可伸缩快速脱落棘轮扳手



3/8"
9.5 mm
72T
CrV
6135



YATO	Ø	T	L [mm]	PCS ROZB.	☐
YT-0731	3/8" (9.5 mm)	72	200	6	6/48



YATO	Ø	T	L [mm]	PCS ROZB.	☐
YT-0298	3/8" (9.5 mm)	72	215-315	6	6/24

EN Hexagonal socket
 PL Nasadka sześciokątna
 DE Sechskantenschlüssel
 RU Головка шестигранная короткая
 CZ Šestihranný nástavec
 HU Dugókulcs hatszög
 RO Cheie tubulară hexagonală
 FR Douille courte
 IT Chiave a bussola esagonale
 ES Bquilla hexagonal corta
 CN 六角套筒

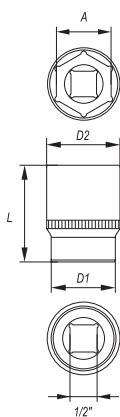

1/2"
12.7mm

DIN
3121

CrV
50BV30

AS-DRIVE



- Drive locks
- Surface finish: chromed, satin / mirror
- Zamki blokujące
- Wykończenie powierzchni: chromowana, satynowa / polerowana

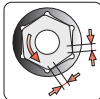

YATO	∅ A [mm]	D1 [mm]	D2 [mm]	L [mm]	PCS PER PKG	
YT-1201	8	12	22	38	12	120/240
YT-1202	9	14	22	38	12	120/240
YT-1203	10	15	22	38	12	120/240
YT-1204	11	16	22	38	12	120/240
YT-1205	12	18	22	38	12	120/240
YT-1206	13	19	22	38	12	120/240
YT-1207	14	20	22	38	12	120/240
YT-1208	15	21	22	38	12	120/240
YT-1209	16	23	22	38	12	120/240
YT-1210	17	24	23	38	12	120/240
YT-1211	18	25	23	38	12	120/240
YT-1212	19	27	24	38	12	120/240
YT-1213	20	28	24	38	12	120/240
YT-1214	21	29	24	38	12	120/240
YT-1215	22	30	26	38	12	120/240
YT-1216	23	31	28	38	12	60/120
YT-1217	24	32	28	38	12	60/120
YT-1218	27	36	30	42	12	60/120
YT-1219	30	40	34	42	12	60/120
YT-1220	32	42	36	42	6	24/48

EN Spline socket
 PL Nasadka Spline
 DE Steckschlüssel Spline
 RU Головка Spline
 CZ Nástrčný kľúč profil Spline
 HU Dugókulcs Spline
 RO Cheie tubulară cu stifturi
 FR Douille
 IT Chiave a bussola Spline
 ES Bquilla Spline
 CN 花键型套筒

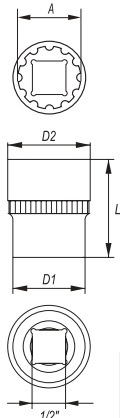

1/2"
12.7mm

DIN
3121

CrV
50BV30



- Drive locks
- Enables to undo 5 types of screws
- Surface finish: chromed, satin / mirror
- Zamki blokujące
- Możliwość odkręcenia 5 rodzajów śrub
- Wykończenie powierzchni: chromowana, satynowa / polerowana

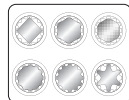

YATO	∅ A [mm]	D1 [mm]	D2 [mm]	L [mm]	PCS PER PKG	
YT-1460	8	13	22	38	12	120/240
YT-1461	9	15	22	38	12	120/240
YT-1462	10	16	22	38	12	120/240
YT-1463	11	17	22	38	12	120/240
YT-1464	12	18	22	38	12	120/240
YT-1465	13	19	22	38	12	120/240
YT-1466	14	20	22	38	12	120/240
YT-1467	15	22	23	38	12	120/240
YT-1468	16	23	22	38	12	120/240
YT-1469	17	25	23	38	12	120/240
YT-1470	18	26	23	38	12	120/240
YT-1471	19	27	24	38	12	120/240
YT-1472	20	28	24	38	12	120/240
YT-1473	21	30	24	38	12	120/240
YT-1474	22	31	26	38	12	120/240
YT-1475	23	32	28	38	12	60/120
YT-1476	24	34	28	38	12	60/120
YT-1478	27	37	30	42	12	60/120
YT-1480	30	41	34	42	6	60/120
YT-1481	32	44	36	42	6	60/120

EN Bi-hexagonal socket
 PL Nasadka dwunastokątna
 DE Zwölfkant-Steckschlüssel-Einsatz
 RU Головка 12-гранная
 CZ Nástrčný oheč dvanáctihránný
 HU Dugókulcs 12-szögű
 RO Cheie tubulară bihexagonală
 FR Douille courte
 IT Chiave a bussola bi-esagonale
 ES Bquilla de anillo
 CN 十二角套筒

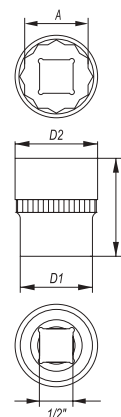

1/2"
12.7mm

DIN
3121

CrV
50BV30

AS-DRIVE



- Drive locks
- Surface finish: chromed, satin / mirror
- Zamki blokujące
- Wykończenie powierzchni: chromowana, satynowa / polerowana

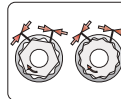

YATO	∅ A [mm]	D1 [mm]	D2 [mm]	L [mm]	PCS PER PKG	
YT-1270	8	12	22	38	12	120/240
YT-1271	9	14	22	38	12	120/240
YT-1272	10	15	22	38	12	120/240
YT-1273	11	16	22	38	12	120/240
YT-1274	12	17	22	38	12	120/240
YT-1275	13	19	22	38	12	120/240
YT-1276	14	20	22	38	12	120/240
YT-1277	15	21	22	38	12	120/240
YT-1278	16	23	22	38	12	120/240
YT-1279	17	24	22	38	12	120/240
YT-1280	18	25	23	38	12	120/240
YT-1281	19	27	24	38	12	120/240
YT-1282	20	28	24	38	12	120/240
YT-1283	21	29	24	38	12	120/240
YT-1284	22	30	26	38	12	120/240
YT-1285	23	31	28	38	12	60/120
YT-1286	24	32	28	38	12	60/120
YT-1289	27	36	30	42	12	60/120
YT-1291	30	40	34	42	6	48/96
YT-1292	32	42	36	42	6	48/96

EN Spline socket
 PL Nasadka Spline
 DE Steckschlüssel Spline
 RU Головка Spline
 CZ Nástrčný kľúč profil Spline
 HU Dugókulcs Spline
 RO Cheie tubulară cu stifturi
 FR Douille
 IT Chiave a bussola Spline
 ES Bquilla Spline
 CN 花键型套筒

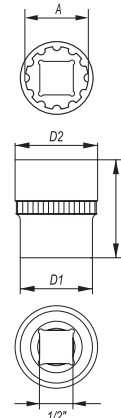

1/2"
12.7mm

DIN
3121

CrV
50BV30



- Drive locks
- Enables to undo 5 types of screws
- Surface finish: chromed, satin / mirror
- Zamki blokujące
- Możliwość odkręcenia 5 rodzajów śrub
- Wykończenie powierzchni: chromowana, satynowa / polerowana

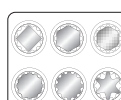

YATO	∅ A [mm]	D1 [mm]	D2 [mm]	L [mm]	PCS PER PKG	
YT-14820	8	13	22	38	10	200
YT-14821	9	15	22	38	10	200
YT-14822	10	16	22	38	10	200
YT-14824	12	18	22	38	10	200
YT-14825	13	19	22	38	10	200
YT-14826	14	20	22	38	10	200
YT-14827	15	22	22	38	10	200
YT-14828	16	23	22	38	10	200
YT-14829	17	25	23	38	10	200
YT-14830	18	26	23	38	10	200
YT-14831	19	27	24	38	10	200
YT-14833	21	30	24	38	10	160
YT-14834	22	31	26	38	10	160
YT-14836	24	34	28	38	10	160
YT-14838	30	41	34	42	5	60
YT-14839	32	44	36	45	5	60

EN Hexagonal deep socket
PL Nasadka sześciokątna długa
DE Sechskantenschlüssel, lange
RU Головка шестигранная длинная
CZ Šestihranný hluboký nástavec
HU Dugókulcs hatszög hosszú
RO Cheie tubulară hexagonală adâncă
FR Douille longue
IT Chiave a bussola esagonale
ES Boquilla hexagonal larga
CN 六角长套筒

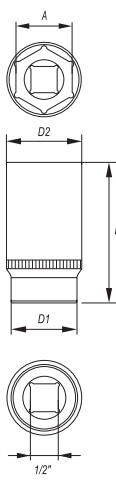

1/2"
12.7mm

DIN
3121

CrV
50BV30

AS-DRIVE



- Drive locks
- Surface finish: chromed, satin / mirror
- Zamki blokujące
- Wykończenie powierzchni: chromowana, satynowa / polerowana

YATO	Ø A [mm]	D1 [mm]	D2 [mm]	L [mm]	PCS ROBIE	Icon
YT-1221	8	13	22	76	12	60/120
YT-1222	9	14	22	76	12	60/120
YT-1223	10	15	22	76	12	60/120
YT-1224	11	17	22	76	12	60/120
YT-1225	12	18	22	76	12	60/120
YT-1226	13	19	22	76	12	60/120
YT-1227	14	20	22	76	12	60/120
YT-1228	15	21	22	76	12	60/120
YT-1229	16	24	22	76	12	60/120
YT-1230	17	24	22	76	12	60/120
YT-1231	18	25	23	76	12	60/120
YT-1232	19	27	24	76	12	60/120
YT-1233	20	28	24	76	12	60/120
YT-1234	21	29	24	76	12	60/120
YT-1235	22	30	26	76	12	60/120
YT-1236	23	31	28	76	12	60/120
YT-1237	24	32	28	76	12	60/120
YT-1238	27	36	30	76	12	36/72
YT-1239	30	40	36	76	12	24/48
YT-1240	32	42	38	76	6	24/48

EN Bi-hexagonal deep socket
PL Nasadka dwunastokątna długa
DE Zwölfkant-Steckschlüssel-Einsatz, lange
RU Головка 12-гранная длинная
CZ Dvanáctihřanný hluboký nástavec
HU Dugókulcs 12-szögű hosszú
RO Cheie tubulară bihexagonală adâncă
FR Douille longue
IT Chiave a bussola bi-esagonale
ES Boquilla de anillo larga
CN 十二角长套筒

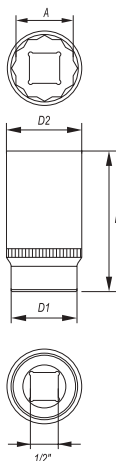

1/2"
12.7mm

DIN
3121

CrV
50BV30

AS-DRIVE



YATO	Ø A [mm]	D1 [mm]	D2 [mm]	L [mm]	PCS ROBIE	Icon
YT-12930	8	22	14	77	12	60/120
YT-12931	9	22	16	77	12	60/120
YT-12932	10	22	16	77	12	60/120
YT-12933	11	22	18	77	12	60/120
YT-12934	12	22	18	77	12	60/120
YT-12935	13	22	19	77	12	60/120
YT-12936	14	22	19	77	12	60/120
YT-12937	15	21	22	77	12	60/120
YT-12938	16	21	22	77	12	60/120
YT-12939	17	22	24	77	12	60/120
YT-12940	18	22	26	77	12	60/120
YT-12941	19	22	26	77	12	60/120
YT-12942	20	24	28	77	12	60/120
YT-12943	21	24	28	77	12	60/120
YT-12944	22	26	30	77	12	60/120
YT-12945	23	27	32	77	12	60/120
YT-12946	24	28	32	77	12	60/120
YT-12947	27	30	36	77	12	36/72
YT-12948	30	34	40	77	6	24/48
YT-12949	32	36	42	77	6	24/48

EN Extension bar
PL Przedłużka
DE Verlängerung
RU Удлинитель для воротка
CZ Prodlužovací přípravek
HU Toldalék

RO Prelungitor
FR Rallonge
IT Prolunga
ES Tubo de prolongación
CN 接杆

1/2"
12.7mm

DIN
3121

CrV
50BV30

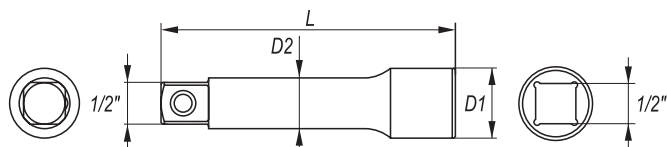

YATO	Ø	D1 [mm]	D2 [mm]	L [mm]	PCS ROBIE	Icon
YT-1246	1/2" (12.7 mm)	24	14.5	76	15	30/120
YT-1247	1/2" (12.7 mm)	24	14.5	127	5	20/80
YT-1248	1/2" (12.7 mm)	24	14.5	254	5	20/40

EN Extension bar with wobble
PL Przedłużka uchylna
DE Gelenkverlängerung
RU Удлинитель наклонный
CZ Odchylný prodlužovací přípravek
HU Csuklós toldalék

RO Prelungitor rabatabil
FR Rallonge angulaire
IT Prolunga
ES Tubo de prolongación desviado
CN 转向接杆

1/2"
12.7mm

DIN
3121

CrV
50BV30

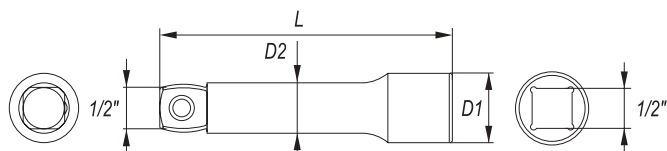

YATO	Ø	D1 [mm]	D2 [mm]	L [mm]	PCS ROBIE	Icon
YT-1249	1/2" (12.7 mm)	24	14.5	76	15	30/120
YT-1250	1/2" (12.7 mm)	24	14.5	127	5	20/80
YT-1251	1/2" (12.7 mm)	24	14.5	254	5	20/40

EN Adapter
PL Redukcja
DE Reduktion
RU Переходник
CZ Redukce
HU Redukció
RO Reducție
FR Réduction
IT Riduttore
ES Reducción
CN 转换头

1/2"
12.7mm

3/4"
19mm

DIN
3121

CrV
50BV30

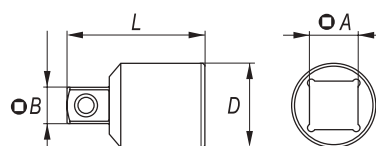

YATO	Ø A	Ø B	D [mm]	L [mm]	PCS ROBIE	Icon
YT-1255	1/2" (12.7 mm) (F)	3/8" (9.5 mm) (M)	22	34.0	10	100/200
YT-1258	1/2" (12.7 mm) (F)	3/4" (19.0 mm) (M)	27	45.5	10	50/100
YT-1259	3/4" (19.0 mm) (F)	1/2" (12.7 mm) (M)	35	51.0	5	50/100
YT-1356	1/2" (12.7 mm) (F)	3/4" (19.0 mm) (M)	26	48.0	12	48

EN Bit adapter
 PL Adapter do bitów
 DE Bithalter
 RU Держатель винтовёртовых наконечников
 CZ Držák na šroubovakové koncovky
 HU Szár a csavarhúzóvégekhöz
 RO Capete surubelnită
 FR Adaptateur d'embouts
 IT Chiave esagonale a bussola
 ES Mandril para puntas
 CN 旋具头接头

1/2"
12.7mm
CrV
6140

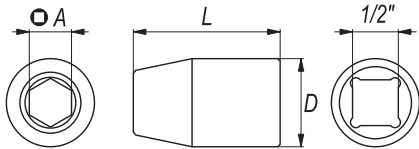

YATO	Ø	Ø A [mm]	D [mm]	L [mm]	PCS PER PKG	
YT-12951	1/2" (12.7 mm)	8	21.9	38	5/300	

EN Bit adapter
 PL Adapter do bitów
 DE Bithalter
 RU Держатель винтовёртовых наконечников
 CZ Držák na šroubovakové koncovky
 HU Szár a csavarhúzóvégekhöz
 RO Capete surubelnită
 FR Adaptateur d'embouts
 IT Chiave esagonale a bussola
 ES Mandril para puntas
 CN 旋具头接头

1/2"
12.7mm
CrV
6140

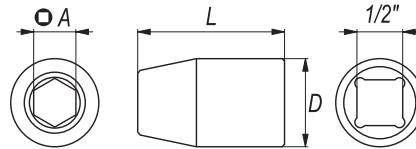

YATO	Ø	Ø A [mm]	D [mm]	L [mm]	PCS PER PKG	
YT-1295	1/2" (12.7 mm)	8	21.9	38	10/150/300	

EN Universal joint
 PL Przegub Cardana
 DE Kardangelenk
 RU Карданный шарнир
 CZ Kardanový kloub
 HU Kardán csukló
 RO Articulație Cardanică
 FR Cardan
 IT Snodo cardanico
 ES Articulación Cardan
 CN 万向接头



1/2"
12.7mm
DIN
3121
CrV
50BV30

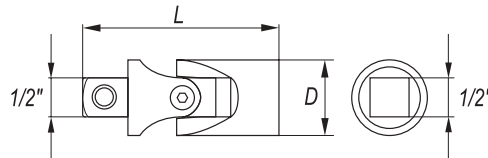

YATO	Ø	D [mm]	L [mm]	PCS PER PKG	
YT-1252	1/2" (12.7 mm)	25	69	5/50/100	

EN Sliding T-bar
 PL Pokreńto typu „T”
 DE Handgriff mit Gleitstück
 RU Вороток Т-образный
 CZ Otočná račká typ „T”
 HU „T” alakú hajtókar
 RO Măner clupă tipul „T”
 FR Barre type „T”
 IT Manopola „T” scorrevole
 ES Mango tipo „T”
 CN 滑行杆

1/2"
12.7mm
DIN
3121
CrV
50BV30

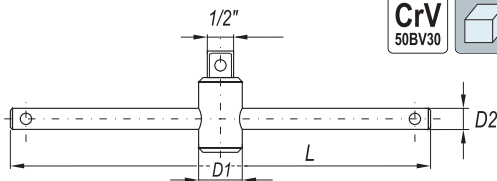

YATO	Ø	D1 [mm]	D2 [mm]	L [mm]	PCS PER PKG	
YT-1243	1/2" (12.7 mm)	24	13.5	255	4/24/48	

EN Flexible handle
 PL Pokreńto lamane
 DE Gelenkgriff
 RU Вороток шарнирный
 CZ Otočná lomená račka
 HU Hajlított hajtókar

1/2"
12.7mm
DIN
3121
CrV
50BV30

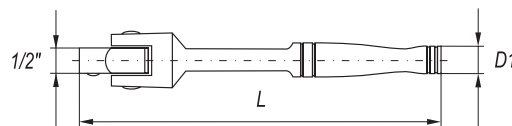

YATO	Ø	D [mm]	L [mm]	PCS PER PKG	
YT-1241	1/2" (12.7 mm)	19	360	5/15/30	
YT-1242	1/2" (12.7 mm)	20	457	5/10/20	

EN L-type handle
 PL Pokreńto typu „L”
 DE Admüternschlüssel
 RU Вороток тип „L”
 CZ Páka zahnutá
 HU „L” alakú hajtókar

RO Măner clupă tipul „L”
 FR Barre type „L”
 IT Leva tipo „L”
 ES Mango tipo „L”
 CN L型套筒扳手

1/2"
12.7mm
DIN
3121
CrV
50BV30

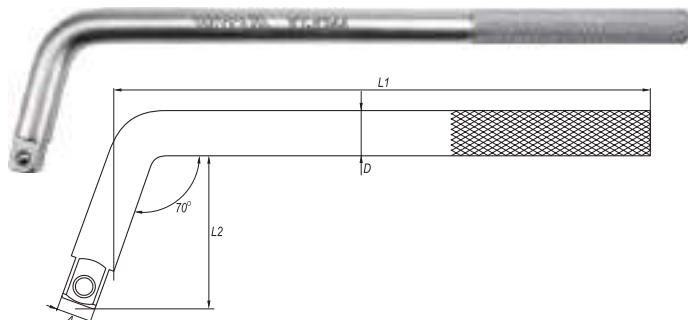

YATO	Ø	D [mm]	L1 [mm]	L2 [mm]	PCS PER PKG	
YT-1244	1/2" (12.7 mm)	16	330	62	3/36	

EN L-type handle
 PL Pokreńto typu „L”
 DE Admüternschlüssel
 RU Вороток тип „L”
 CZ Páka zahnutá
 HU „L” alakú hajtókar

RO Măner clupă tipul „L”
 FR Barre type „L”
 IT Leva tipo „L”
 ES Mango tipo „L”
 CN L型扳手

1/2"
12.7mm
DIN
3122
CrV
50BV30

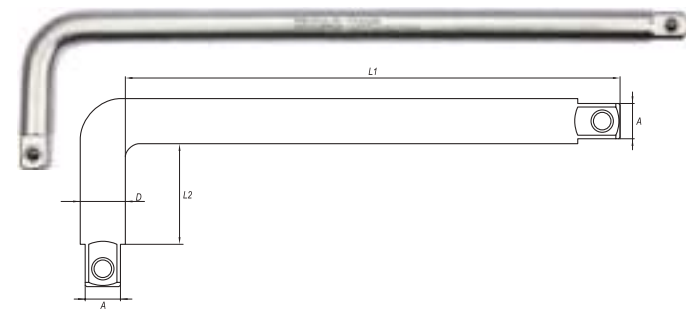

YATO	Ø	D [mm]	L1 [mm]	L2 [mm]	PCS PER PKG	
YT-12439	1/2" (12.7 mm)	16	282	55	10/20	
YT-12445	1/2" (12.7 mm)	16	585	190	4/4/12	

EN Quick release ratchet handle
PL Grzechotka
DE Hebelumschaltknarre
RU Трещотка
CZ Rehtačka
HU Racsnis hajtókar

RO Dispozitiv de prindere cu clichet
FR Clé à cliquet
IT Cricchetto bussola
ES Carraca
CN 快速脱落棘轮扳手

1/2"
12.7mm
DIN
3122
72T
CrV
6140



YATO	Ø	T	L [mm]	PCS ROZB	☐
YT-0309	1/2" (12.7 mm)	72	278	6	24



YATO	Ø	T	L [mm]	PCS ROZB	☐
YT-0312	1/2" (12.7 mm)	72	250	6	12/24



YATO	Ø	T	L [mm]	PCS ROZB	☐
YT-0315	1/2" (12.7 mm)	72	250	6	24



YATO	Ø	T	L [mm]	PCS ROZB	☐
YT-0318	1/2" (12.7 mm)	72	250	6	24



YATO	Ø	T	L [mm]	PCS ROZB	☐
YT-0324	1/2" (12.7 mm)	72	265	6	24

EN Quick release ratchet handle
PL Grzechotka
DE Hebelumschaltknarre
RU Трещотка
CZ Ráčna
HU Racsnis hajtókar

RO Dispozitiv de prindere cu clichet
FR Clé à cliquet
IT Cricchetto bussola
ES Carraca
CN 快速脱落棘轮扳手

1/2"
12.7mm
QUICK
RELEASE
SZYBKO-
ZŁĄCZE
72T
CrV
6140



YATO	Ø	T	L [mm]	PCS ROZB	☐
YT-0732	1/2" (12.7 mm)	72	255	6	24

EN Telescopic ratchet handle
PL Grzechotka z przedłużanym uchwytem
DE Umschaltknarre
RU Трещотка

CZ Ráčna
HU Racsnis hajtókar
RO Antrenor cu clichet
FR Clé à cliquet

IT Cricchetto bussola
ES Carraca telescópico
CN 可伸缩快速脱落棘轮扳手



YATO	Ø	T	L [mm]	PCS ROZB	☐
YT-0299	1/2" (12.7 mm)	72	305-445	6	24

EN Quick release ratchet handle
PL Grzechotka
DE Hebelumschaltknarre
RU Трещотка
CZ Ráčna
HU Racsnis hajtókar
RO Dispozitiv de prindere cu clichet
FR Clé à cliquet
IT Cricchetto bussola
ES Carraca
CN 快速脱落棘轮扳手

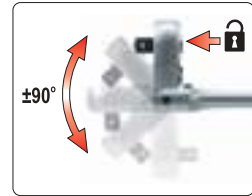

1/2"
12.7mm
DIN
3122
72T
CrV
6140



YATO	Ø	T	L [mm]	PCS ROZB	☐
YT-0327	1/2" (12.7 mm)	72	290	6	1/24

EN Quick release ratchet handle
PL Grzechotka powlekana
DE Hebelumschaltknarre
RU Трещотка
CZ Rehtačka
HU Racsnis hajtókar

RO Dispozitiv de prindere cu clichet
FR Clé à cliquet
IT Cricchetto bussola
ES Carraca
CN 快速脱落棘轮扳手

1/2"
12.7mm
DIN
3122
72T
CrV
6135



YATO	Ø	T	L [mm]	PCS ROZB	☐
YT-0292	1/2" (12.7 mm)	72	257	6	24



YATO	Ø	T	L [mm]	PCS ROZB	☐
YT-0295	1/2" (12.7 mm)	72	257	6	24

EN Quick release ratchet handle
PL Grzechotka
DE Hebelumschaltknarre
RU Трещотка
CZ Ráčna
HU Racsnis hajtókar

RO Dispozitiv de prindere cu clichet
FR Clé à cliquet
IT Cricchetto bussola
ES Carraca
CN 快速脱落棘轮扳手

1/2"
12.7mm
QUICK
RELEASE
SZYBKO-
ZŁĄCZE
72T
CrV
6135





YATO	Ø	T	L [mm]	PCS ROZB	☐
YT-0735	1/2" (12.7 mm)	72	255	6	24

EN Deep socket set
 PL Zestaw nasadek dlugich
 DE Lange Steckschlüsselsatz
 RU Набор высоких головок
 CZ Sada hlubokých nástavců
 HU Hosszú dugókulcs készlet
 RO Set tubulare
 FR Jeu de douilles longues
 IT Set di chiavi a bussola lunghe
 ES Juego de vasos largos
 CN 套筒组套

8 PCS **1/4"** **6.3mm** **CrV** 50BV30 **AS-DRIVE** 









 1/4" (6.3 mm): 5.5, 6, 7, 8, 9, 10, 12, 13 mm (L=50 mm); CrV 50BV30

YATO 		
YT-14431	1/4" (6.3 mm)	10/20

EN Tool set
 PL Zestaw narzędziowy
 DE Werkzeug-Satz
 RU Набор инструмента
 CZ Sada nářadí
 HU Szerszámkészlet
 RO Trusa de scule
 FR Jeu d'outils
 IT Set di utensili
 ES Juego de herramientas
 CN 工具组套

23 PCS **1/4"** **6.3mm** **CrV** 50BV30 **CrMo** 440 **72T** **AS-DRIVE** 









 1/4" (6.3 mm): 4, 5, 6, 7, 8, 9, 10, 12, 13 mm (L=25 mm); CrV 50BV30;
 1/4" (6.3 mm): 4, 5, 6, 7, 8, 9, 10, 12, 13 mm (L=50 mm); CrV 50BV30;
 1/4" (6.3 mm): (50.8, 152.4 mm); CrV 50BV30;
 1/4" (6.3 mm); CrV 50BV30;
 1/4" (6.3 mm); (155 mm); 72T; CrMo 440;
 1/4" (6.3 mm); (150 mm); CrV 50BV30



YATO 		
YT-14451	1/4" (6.3 mm)	10

EN Tool set
 PL Zestaw narzędziowy
 DE Werkzeug-Satz
 RU Набор инструмента
 CZ Sada nářadí
 HU Szerszámkészlet
 RO Trusa de scule
 FR Jeu d'outils
 IT Set di utensili
 ES Juego de herramientas
 CN 工具组套

20 PCS **1/4"** **6.3mm** **CrV** 50BV30 **CrMo** 440 **72T** **AS-DRIVE** 









 1/4" (6.3 mm): 3.5, 4, 4.5, 5, 5.5, 6, 7, 8, 9, 10, 11, 12, 13, 14 mm (L=25 mm); CrV 50BV30;
 1/4" (6.3 mm); (51.6, 151.5 mm); CrV 50BV30;
 1/4" (6.3 mm); CrV 50BV30;
 1/4" (6.3 mm); (152.8 mm); CrV 50BV30;
 1/4" (6.3 mm); (155 mm); 72T; CrMo 440;
 1/4" (6.3 mm); (150 mm); CrV 50BV30



YATO 		
YT-14491	1/4" (6.3 mm)	10

EN Tool set
 PL Zestaw narzędziowy
 DE Werkzeug-Satz
 RU Набор инструмента
 CZ Sada nářadí
 HU Szerszámkészlet
 RO Trusa de scule
 FR Jeu d'outils
 IT Set di utensili
 ES Juego de herramientas
 CN 工具组套

25 PCS **1/4"** **6.3mm** **CrV** 50BV30 **CrMo** 440 **CrV** 40 **72T** **AS-DRIVE** 



 1/4" (6.3 mm): 3.5, 4, 4.5, 5, 5.5, 6, 7, 8, 9, 10, 11, 12, 13, 14 mm (L=25 mm); CrV 50BV30;
 1/4" (6.3 mm): 8, 10, 11, 12, 13 mm (L=50 mm); CrV 50BV30;
 1/4" (6.3 mm); (50.8, 101.6 mm); CrV 50BV30;
 1/4" (6.3 mm); CrV 50BV30;
 1/4" (6.3 mm); (152.4 mm); CrV 40;
 1/4" (6.3 mm); (155 mm); 72T; CrMo 440;
 1/4" (6.3 mm); (150 mm); CrV 50BV30

YATO 		
YT-14461	1/4" (6.3 mm)	10











EN Tool set
PL Zestaw narzędziowy
DE Werkzeug-Satz
RU Набор инструмента



CZ Sada nářadí
HU Szerszámkészlet
RO Trusa de scule
FR Jeu d'outils

IT Set di utensili
ES Juego de herramientas
CN 工具组套

38 PCS	1/4" 6.3mm	CrV 50BV30	CrV 6150	CrV 40
CrMo 440	S2	72T	AS-DRIVE	



-  1/4" (6.3 mm): 3.5, 4, 4.5, 5, 5.5, 6, 7, 8, 9, 10, 11, 12, 13, 14 mm (L=25 mm); CrV 50BV30;
-  1/4" (6.3 mm); (50.8, 101.6 mm); CrV 50BV30;
-  1/4" (6.3 mm); CrV 50BV30;
-  1/4" (6.3 mm); (152.4 mm); CrV 40;
-  1/4" (6.3 mm); (155 mm); 72T; CrMo 440;
-  1/4" (6.3 mm); (150 mm); CrV 50BV30;
-  1/4" (6.3 mm): 4, 5, 5, 6.5 mm (L=37 mm); AISI S2 / CrV 6150;
-  1/4" (6.3 mm): PH1, PH2 (L=37 mm); AISI S2 / CrV 6150;
-  1/4" (6.3 mm): PZ1, PZ2 (L=37 mm); AISI S2 / CrV 6150;
-  1/4" (6.3 mm): T10, T15, T20, T25, T30, T40 (L=37 mm); AISI S2 / CrV 6150;
-  1/4" (6.3 mm): 3, 4, 5, 6, 8 mm (L=37 mm); AISI S2 / CrV 6150

YATO 	○	
YT-14471	1/4" (6.3 mm)	10

EN Tool set
PL Zestaw narzędziowy
DE Werkzeug-Satz















RU Набор инструмента
CZ Sada nářadí
HU Szerszámkészlet



RO Trusa de scule
FR Jeu d'outils
IT Set di utensili

ES Juego de herramientas
CN 工具组套

56 PCS	1/4" 6.3mm	CrV 50BV30	CrV 6150	CrV 40
CrMo 440	S2	72T	AS-DRIVE	



-  1/4" (6.3 mm): 4, 4.5, 5, 5.5, 6, 7, 8, 9, 10, 11, 12, 13 mm (L=25 mm); CrV 50BV30;
-  1/4" (6.3 mm): 6, 7, 8, 9, 10, 11, 12, 13 mm (L=50 mm); CrV 50BV30;
-  1/4" (6.3 mm): E4, E5, E6, E7, E8, E10; CrV 6150;
-  1/4" (6.3 mm); (76, 152.4 mm); CrV 50BV30;
-  1/4" (6.3 mm); (150 mm); CrV 50BV30;
-  1/4" (6.3 mm); CrV 50BV30;
-  1/4" (6.3 mm); (152.4 mm); CrV 40;
-  1/4" (6.3 mm); (155 mm); 72T; CrMo 440;
-  1/4" (6.3 mm); (150 mm); CrV 50BV30;
-  1/4" (6.3 mm) (F) x 3/8" (9.5 mm) (M); CrV 50BV30;
-  1/4" (6.3 mm): 4, 5, 5, 6.5 mm (L=37 mm); AISI S2 / CrV 6150;
-  1/4" (6.3 mm): PH1, PH2, PH3 (L=37 mm); AISI S2 / CrV 6150;
-  1/4" (6.3 mm): PZ1, PZ2, PZ3 (L=37 mm); AISI S2 / CrV 6150;
-  1/4" (6.3 mm): T8, T10, T15, T20, T25, T30, T40 (L=37 mm); AISI S2 / CrV 6150;
-  1/4" (6.3 mm): 3, 4, 5, 6, 7, 8 mm (L=37 mm); AISI S2 / CrV 6150

YATO 	○	
YT-14501	1/4" (6.3 mm)	10

EN Tool set
PL Zestaw narzędziowy
DE Werkzeug-Satz





RU Набор инструмента
CZ Sada nářadí
HU Szerszámkészlet



RO Trusa de scule
FR Jeu d'outils
IT Set di utensili

ES Juego de herramientas
CN 工具组套

22 PCS	3/8" 9.5mm	CrV 50BV30	CrV 40
CrMo 440	72T	AS-DRIVE	



-  3/8" (9.5 mm): 6, 7, 8, 9, 10, 11, 12, 13, 14, 15, 16 mm (L=28 mm); 17, 18, 19, 20, 21, 22 mm (L=30 mm); CrV 50BV30;
-  3/8" (9.5 mm); (76, 152.4 mm); CrV 50BV30;
-  3/8" (9.5 mm); CrV 50BV30;
-  3/8" (9.5 mm); (198 mm); CrV 40;
-  3/8" (9.5 mm); (200 mm); 72T; CrMo 440

YATO 	○	
YT-38561	3/8" (9.5 mm)	10

EN Deep socket set
 PL Zestaw nasadek dlugich
 DE Lange Steckschlüsselsatz
 RU Набор высоких головок
 CZ Sada hlubokých nástavců
 HU Hosszú dugókulcs készlet
 RO Set tubulare
 FR Jeu de douilles longues
 IT Set di chiavi a bussola lunghe
 ES Juego de vasos largos
 CN 套筒组套



10
PCS
 1/2"
12.7mm
 CrV
50BV30
 AS-DRIVE

1/2" (12.7 mm): 10, 12, 13, 14, 15, 17, 19, 21, 22, 24 mm (L=76 mm); CrV 50BV30

YATO		
YT-38861	1/2" (12.7 mm)	5/10

EN Socket set and accessories
 PL Zestaw nasadek z akcesoriami
 DE Steckschlüsselsatz mit Zubehör
 RU Набор головок с принадлежностями
 CZ Sada nástavců s příslušenstvím
 HU Dugókulcs készlet tartozékokkal
 RO Trusă tubulare cu accesorii
 FR Jeu de douilles et accessoires
 IT Set di chiavi a bussola con accessori
 ES Juego de vasos y accesorios
 CN 套筒组套



12
PCS
 1/2"
12.7mm
 CrV
50BV30
 CrMo
440
 72T
 AS-DRIVE

1/2" (12.7 mm): 10, 11, 12, 13, 14, 15, 17, 19, 21, 24 mm (L=38 mm); CrV 50BV30;
 1/2" (12.7 mm): (127 mm); CrV 50BV30;
 1/2" (12.7 mm): (255 mm); 72T, CrMo 440

YATO		
YT-38821	1/2" (12.7 mm)	5/10

EN Socket and ratchet set
 PL Zestaw nasadek z grzechotką
 DE Steckschlüsselsatz mit Hebelumschaltknarre
 RU Набор головок с трещоткой
 CZ Sada nástavců a ráčny
 HU Dugókulcs készlet racsnis hajtókarral
 RO Trusă tubulare și antrenor
 FR Jeu de douilles et clé à cliquet
 IT Set di chiavi a bussola con cricchetto
 ES Juego de vasos y carraca
 CN 套筒组套



19
PCS
 1/2"
12.7mm
 CrV
50BV30
 CrMo
440
 72T
 AS-DRIVE

1/2" (12.7 mm): 8, 9, 10, 11, 12, 13, 14, 15, 16, 17, 19, 21, 22, 23, 24 mm (L=38 mm); 27, 30, 32 mm (L=42 mm); CrV 50BV30;
 1/2" (12.7 mm): (255 mm); 72T; CrMo 440

YATO		
YT-38681	1/2" (12.7 mm)	3/6

EN Tool set
 PL Zestaw narzędziowy
 DE Werkzeug-Satz
 RU Набор инструмента
 CZ Sada náradí
 HU Szerszámkészlet

RO Trusa de scule
 FR Jeu d'outils
 IT Set di utensili
 ES Juego de herramientas
 CN 工具组套

12
PCS
 1/2"
12.7mm
 CrV
50BV30
 CrMo
440
 72T
 AS-DRIVE



1/2" (12.7 mm): 10, 11, 12, 13, 14, 15, 17, 19, 21, 24 mm (L=38 mm); CrV 50BV30;
 1/2" (12.7 mm): (127 mm); CrV 50BV30;
 1/2" (12.7 mm): (255 mm); 72T; CrMo 440

YATO		
YT-38671	1/2" (12.7 mm)	10

EN Tool set
 PL Zestaw narzędziowy
 DE Werkzeug-Satz

RU Набор инструмента
 CZ Sada náradí
 HU Szerszámkészlet

RO Trusa de scule
 FR Jeu d'outils
 IT Set di utensili

ES Juego de herramientas
 CN 工具组套

25
PCS
 1/2"
12.7mm
 CrV
50BV30
 CrV
6140
 72T
 AS-DRIVE



1/2" (12.7 mm): 10, 11, 12, 13, 14, 15, 16, 17, 18, 19, 20, 21, 22, 23, 24 mm (L=38 mm); 27, 30, 32 mm (L=42 mm); CrV 50BV30;
 1/2" (12.7 mm): (127 mm); CrV 50BV30;
 1/2" (12.7 mm): 16, 21 mm; CrV 50BV30;
 1/2" (12.7 mm): (255 mm); CrV 50BV30;
 1/2" (12.7 mm): (255 mm); 72T; CrV 6140;
 1/2" (12.7 mm): (317 mm); CrV 50BV30;
 1/2" (12.7 mm) (F) x 3/8" (9.5 mm) (M); CrV 50BV30

YATO		
YT-38741	1/2" (12.7 mm)	2

EN Tool set
PL Zestaw narzędziowy
DE Werkzeug-Satz
RU Набор инструмента

CZ Sada nářadí
HU Szerszámkészlet
RO Trusa de scule
FR Jeu d'outils

IT Set di utensili
ES Juego de herramientas
CN 工具组套

60 PCS	1/2" 12.7mm	1/4" 6.3mm	CrV 50BV30	CrV 6150
CrV 6140	S2	72T	AS-DRIVE	

2



- 1/2" (12.7 mm): 10, 11, 12, 13, 14, 15, 16, 17, 18, 19, 20, 21, 22, 24 mm (L=38 mm); 27, 30, 32 mm (L=42 mm); CrV 50BV30;
- 1/2" (12.7 mm); (127 mm; 254 mm); CrV 50BV30;
- 1/2" (12.7 mm): 16, 21 mm; CrV 50BV30;
- 1/2" (12.7 mm): 10, 11, 12, 13, 14, 15, 16, 17, 18, 19 mm (L=76 mm); CrV 50BV30;
- 3/8" (9.5 mm) (F) x 1/2" (12.7 mm) (M); CrV 50BV30;
- 1/2" (12.7 mm); CrV 50BV30;
- 1/2" (12.7 mm); (255 mm); 72T; CrV 6140;
- 1/4" (6.3 mm); (150 mm); CrV 50BV30;
- 1/4" (6.3 mm) x 1/4" (6.3 mm); CrV 6140;
- 1/4" (6.3 mm); 2, 3, 4, 5, 6, 7, 8 mm (L=25 mm); AISI S2;
- 1/4" (6.3 mm); PZ1, PZ2, PZ3 (L=25 mm); AISI S2;
- 1/4" (6.3 mm); T8, T10, T15, T20, T25, T27, T30, T40 (L=25 mm); AISI S2;
- 1/4" (6.3 mm); 4, 5.5, 6.5 mm (L=37 mm); AISI S2 / CrV 6150;
- 1/4" (6.3 mm); PH1, PH2, PH3 (L=37 mm); AISI S2 / CrV 6150

YATO		
YT-12660	1/4" (6.3 mm), 1/2" (12.7 mm)	4

EN Tool set
PL Zestaw narzędziowy
DE Werkzeug-Satz
RU Набор инструмента

CZ Sada nářadí
HU Szerszámkészlet
RO Trusa de scule
FR Jeu d'outils

IT Set di utensili
ES Juego de herramientas
CN 工具组套

72 PCS	1/2" 12.7mm	1/4" 6.3mm	CrV 50BV30	CrV 6150
CrV 6140	72T	AS-DRIVE		



- 1/2" (12.7 mm): 10, 11, 12, 13, 14, 15, 16, 17, 18, 19, 20, 21, 22, 23, 24 mm (L=38 mm); 27 mm (L=42 mm); 1/4" (6.3 mm): 4, 5, 6, 7, 8, 9, 10, 11, 12, 13 mm (L=25 mm); CrV 50BV30;
- 1/2" (12.7 mm); (127, 254 mm); 1/4" (6.3 mm); (152.4 mm); CrV 50BV30;
- 3/8" (9.5 mm) (F) x 1/2" (12.7 mm) (M); CrV 50BV30;
- 1/2" (12.7 mm); CrV 50BV30;
- 1/2" (12.7 mm): 21 mm; CrV 50BV30;
- 1/2" (12.7 mm); (255 mm); 1/4" (6.3 mm); (155 mm); 72T; CrV 6140;
- 1/4" (6.3 mm); (150 mm); CrV 50BV30;
- 1/4" (6.3 mm) x 1/4" (6.3 mm); CrV 6140;
- 1/4" (6.3 mm); 4, 5, 5.5, 6, 7 mm (L=25 mm); CrV 6150;
- 1/4" (6.3 mm); PH0, PH1, PH2, PH3 (L=25 mm); CrV 6150;
- 1/4" (6.3 mm); PZ0, PZ1, PZ2, PZ3 (L=25 mm); CrV 6150;
- 1/4" (6.3 mm); T8, T9, T10, T15, T20, T25, T27, T30, T40 (L=25 mm); CrV 6150;
- 1/4" (6.3 mm); 3, 4, 5, 6, 7, 8 mm (L=25 mm); CrV 6150;
- 1/4" (6.3 mm); S0, S1, S2, S3 (L=25 mm); CrV 6150;
- 1.25, 1.5, 2.5, 3 mm; CrV 6150

YATO		
YT-38782	1/4" (6.3 mm), 1/2" (12.7 mm)	4

EN Tool set
 PL Zestaw narzędziowy
 DE Werkzeug-Satz

RU Набор инструмента
 CZ Sada náradí
 HU Szerszámkészlet

RO Trusa de scule
 FR Jeu d'outils
 IT Set di utensili

ES Juego de herramientas
 CN 工具组套

77 PCS	1/2" 12.7mm	1/4" 6.3mm	CrV 50BV30	CrV 6150
CrMo 440	S2	72T	AS-DRIVE	



- 1/2" (12.7 mm): 10, 11, 12, 13, 14, 15, 17, 19, 22, 24 mm (L=38 mm); 27, 30, 32 mm (L=42 mm);
- 1/4" (6.3 mm): 4, 5, 6, 7, 8, 9, 10, 11, 12 mm (L=25 mm); CrV 50BV30;
- 1/2" (12.7 mm): (127, 254 mm), 1/4" (6.3 mm): (76, 101.6 mm); CrV 50BV30;
- 1/2" (12.7 mm), 1/4" (6.3 mm); CrV 50BV30;
- 1/2" (12.7 mm): 16, 21 mm; CrV 50BV30;
- 1/2" (12.7 mm): (255 mm), 1/4" (6.3 mm): (155 mm); 72T; CrMo 440;
- 1/4" (6.3 mm) x 1/4" (6.3 mm); CrV 50BV30;
- 1/4" (6.3 mm) x 1/4" (6.3 mm); CrV 50BV30;
- 1/4" (6.3 mm): 3, 4, 5.5, 7 mm (L=25 mm); AISI S2;
- 1/4" (6.3 mm): PH0, PH1, PH2, PH3 (L=25 mm); AISI S2;
- 1/4" (6.3 mm): PZ1, PZ2, PZ3 (L=25 mm); AISI S2;
- 1/4" (6.3 mm): T10, T15, T20, T25, T30 (L=25 mm); AISI S2;
- 1/4" (6.3 mm): 2, 3, 4, 5, 6 mm (L=25 mm); AISI S2;
- 7, 8, 9, 10, 11, 12, 13, 14, 15, 17, 19 mm; CrV;
- 8x9, 10x11, 12x13, 14x15 mm; CrV 50BV30;
- 1.5, 2, 2.5, 5, 6, 8, 10 mm; CrV 6150

YATO	
YT-38781	1/4" (6.3 mm), 1/2" (12.7 mm)
	2

EN Tool set
 PL Zestaw narzędziowy
 DE Werkzeug-Satz

RU Набор инструмента
 CZ Sada náradí
 HU Szerszámkészlet

RO Trusa de scule
 FR Jeu d'outils
 IT Set di utensili

ES Juego de herramientas
 CN 工具组套

79 PCS	1/2" 12.7mm	1/4" 6.3mm	CrV 50BV30	CrV 6140	CrV 60
CrMo	SK5	S2	72T	AS-DRIVE	



- 1/2" (12.7 mm): 10, 11, 12, 13, 14, 16, 17, 19, 22, 24, 26 mm (L=38 mm); 27, 30, 32 mm (L=42 mm); 1/4" (6.3 mm): 5, 6, 7, 8, 9, 10, 11, 12, 13 mm (L=25 mm); CrV 50BV30;
- 1/2" (12.7 mm): 10, 11, 12, 13, 14, 17, 19 mm (L=76 mm); CrV 50BV30;
- 1/2" (12.7 mm): (125 mm), 1/4" (6.3 mm): (50 mm); CrV 50BV30;
- 1/2" (12.7 mm); CrV 50BV30;
- 1/2" (12.7 mm): 16, 21 mm; CrV 50BV30;
- 1/2" (12.7 mm): (255 mm), 1/4" (6.3 mm): (155 mm); 72T; CrV 6140;
- 1/4" (6.3 mm): (150 mm); CrV 50BV30;
- 1/2" (12.7 mm): (457 mm);
- 6, 7, 8, 9, 10, 11, 12, 13, 14, 16, 17, 19, 22, 24 mm; CrV;
- 2.0x50, 2.4x75 mm; S2;
- 3.0x75, 4.0x100, 6.5x150, 8.0x150 mm; S2;
- PH0x75 mm; S2;
- PH1x75, PH2x100 mm; S2;
- 180 mm;
- 160 mm;
- 160, 200 mm;
- 250 mm;
- 300 g;
- 300 mm;
- 180 mm; CrMo;
- 120 mm; CrV 60;
- SK5;
- 2.5, 3, 4, 5, 6, 8, 10 mm; CrV

YATO	
YT-38911	1/4" (6.3 mm), 1/2" (12.7 mm)
	2

EN Tool set
PL Zestaw narzędziowy
DE Werkzeug-Satz

RU Набор инструмента
CZ Sada náradí
HU Szerszámkészlet

RO Trusa de scule
FR Jeu d'outils
IT Set di utensili

ES Juego de herramientas
CN 工具组套

82
PCS

1/2"
12.7mm

1/4"
6.3mm

CrV
50BV30

CrV
6150

CrV
40

CrMo
440

S2

72T

AS-DRIVE



2



- 1/2" (12.7 mm): 14, 15, 16, 17, 18, 19, 20, 22, 24 mm (L=38 mm); 27, 30, 32 mm (L=42 mm); 1/4" (6.3 mm): 4, 4.5, 5, 5.5, 6, 7, 8, 9, 10, 11, 12, 13, 14 mm (L=25 mm); CrV 50BV30;
- 1/2" (12.7 mm); (127, 254 mm), 1/4" (6.3 mm); (50.8, 101.6 mm); CrV 50BV30;
- 3/8" (9.5 mm) (F) x 1/2" (12.7 mm) (M); CrV 50BV30;
- 1/4" (6.3 mm); (150 mm); CrV 50BV30;
- 1/2" (12.7 mm), 1/4" (6.3 mm); CrV 50BV30;
- 1/2" (12.7 mm): 16, 21 mm; CrV 50BV30;
- 1/4" (6.3 mm); (152.4 mm); CrV 40;
- 1/2" (12.7 mm); (255 mm), 1/4" (6.3 mm); (155 mm); 72T, CrMo 440;
- 1/4" (6.3 mm); (150 mm); CrV 50BV30;
- 1/2" (12.7 mm) x 5/16" (7.9 mm); CrV 50BV30;
- 1/4" (6.3 mm) x 1/4" (6.3 mm); CrV 50BV30;
- 5/16" (7.9 mm): 8, 10, 12 mm (L=30 mm); AISI S2;
- 5/16" (7.9 mm): PH3, PH4 (L=30 mm); AISI S2;
- 5/16" (7.9 mm): PZ3, PZ4 (L=30 mm); AISI S2;
- 5/16" (7.9 mm): T40, T45, T50, T55 (L=30 mm); AISI S2;
- 5/16" (7.9 mm): 8, 10, 12, 14 mm (L=30 mm); AISI S2;
- 1/4" (6.3 mm): 4, 5.5, 7 mm (L=37 mm); AISI S2 / CrV 6150;
- 1/4" (6.3 mm): PH1, PH2 (L=37 mm); AISI S2 / CrV 6150;
- 1/4" (6.3 mm): PZ1, PZ2 (L=37 mm); AISI S2 / CrV 6150;
- 1/4" (6.3 mm): T8, T10, T15, T20, T25, T30 (L=37 mm); AISI S2 / CrV 6150;
- 1/4" (6.3 mm): 3, 4, 5, 6 mm (L=37 mm); AISI S2 / CrV 6150;
- 8, 10, 11, 12, 13, 14, 17, 19, 22 mm; CrV

YATO	O	☐
YT-12691	1/4" (6.3 mm), 1/2" (12.7 mm)	2

EN Tool set
PL Zestaw narzędziowy
DE Werkzeug-Satz

RU Набор инструмента
CZ Sada náradí
HU Szerszámkészlet

RO Trusa de scule
FR Jeu d'outils
IT Set di utensili

ES Juego de herramientas
CN 工具组套

94
PCS

1/2"
12.7mm

1/4"
6.3mm

CrV
50BV30

CrV
6150

CrV
40

CrMo
440

S2

72T

AS-DRIVE



- 1/2" (12.7 mm): 10, 11, 12, 13, 14, 15, 16, 17, 18, 19, 20, 21, 22, 23, 24 mm (L=38 mm); 27, 30, 32 mm (L=42 mm); 1/4" (6.3 mm): 4, 4.5, 5, 5.5, 6, 7, 8, 9, 10, 11, 12, 13, 14 mm (L=25 mm); CrV 50BV30;
- 1/2" (12.7 mm): 14, 15, 17, 19 mm (L=76 mm), 1/4" (6.3 mm): 6, 7, 8, 9, 10, 11, 12, 13 mm (L=50 mm); CrV 50BV30;
- 1/2" (12.7 mm); (127, 254 mm), 1/4" (6.3 mm); (50.8, 101.6 mm); CrV 50BV30;
- 3/8" (9.5 mm) (F) x 1/2" (12.7 mm) (M); CrV 50BV30;
- 1/4" (6.3 mm); (150 mm); CrV 50BV30;
- 1/2" (12.7 mm), 1/4" (6.3 mm); CrV 50BV30;
- 1/2" (12.7 mm): 16, 21 mm; CrV 50BV30;
- 1/4" (6.3 mm); (152.4 mm); CrV 40;
- 1/2" (12.7 mm); (255 mm), 1/4" (6.3 mm); (155 mm); 72T, CrMo 440;
- 1/4" (6.3 mm); (150 mm); CrV 50BV30;
- 1/2" (12.7 mm) x 5/16" (7.9 mm); CrV 50BV30;
- 1/4" (6.3 mm) x 1/4" (6.3 mm); CrV 50BV30;
- 5/16" (7.9 mm): 8, 10, 12 mm (L=30 mm); AISI S2;
- 5/16" (7.9 mm): PH3, PH4 (L=30 mm); AISI S2;
- 5/16" (7.9 mm): PZ3, PZ4 (L=30 mm); AISI S2;
- 5/16" (7.9 mm): T40, T45, T50, T55 (L=30 mm); AISI S2;
- 5/16" (7.9 mm): 8, 10, 12, 14 mm (L=30 mm); AISI S2;
- 1/4" (6.3 mm): 4, 5.5, 7 mm (L=37 mm); AISI S2 / CrV 6150;
- 1/4" (6.3 mm): PH1, PH2 (L=37 mm); AISI S2 / CrV 6150;
- 1/4" (6.3 mm): PZ1, PZ2 (L=37 mm); AISI S2 / CrV 6150;
- 1/4" (6.3 mm): T8, T10, T15, T20, T25, T30 (L=37 mm); AISI S2 / CrV 6150;
- 1/4" (6.3 mm): 3, 4, 5, 6 mm (L=37 mm); AISI S2 / CrV 6150;
- 1.5, 2, 2.5 mm; CrV 6150

YATO	O	☐
YT-12681	1/4" (6.3 mm), 1/2" (12.7 mm)	2

EN Tool set
 PL Zestaw narzędziowy
 DE Werkzeug-Satz

RU Набор инструмента
 CZ Sada nářadí
 HU Szerszámkészlet

RO Trusa de scule
 FR Jeu d'outils
 IT Set di utensili

ES Juego de herramientas
 CN 工具组套

108 PCS	1/2" 12.7mm	1/4" 6.3mm	CrV 50BV30	CrV 6150	CrV 40
CrMo 440	S2	72T	AS-DRIVE		

2



- 1/2" (12.7 mm): 10, 11, 12, 13, 14, 15, 16, 17, 18, 19, 20, 21, 22, 24 mm (L=38 mm); 27, 30, 32 mm (L=42 mm), 1/4" (6.3 mm): 4, 4.5, 5, 5.5, 6, 7, 8, 9, 10, 11, 12, 13, 14 mm (L=25 mm); CrV 50BV30;
- 1/2" (12.7 mm): 14, 15, 17, 19, 22 mm (L=76 mm), 1/4" (6.3 mm): 6, 7, 8, 9, 10, 11, 12, 13 mm (L=50 mm); CrV 50BV30;
- 1/2" (12.7 mm): E10, E11, E12, E14, E16, E18, E20, E24, 1/4" (6.3 mm): E4, E5, E6, E7, E8; CrV 50BV30;
- 1/2" (12.7 mm): (127, 254 mm), 1/4" (6.3 mm): (50.8, 101.6 mm); CrV 50BV30;
- 3/8" (9.5 mm) (F) x 1/2" (12.7 mm) (M); CrV 50BV30;
- 1/2" (12.7 mm), 1/4" (6.3 mm); CrV 50BV30;
- 1/2" (12.7 mm): 16, 21 mm; CrV 50BV30;
- 1/4" (6.3 mm): (152.4 mm); CrV 40;
- 1/2" (12.7 mm): (255 mm), 1/4" (6.3 mm): (155 mm); 72T; CrMo 440;
- 1/4" (6.3 mm): (150 mm); CrV 50BV30;
- 1/2" (12.7 mm) x 5/16" (7.9 mm); CrV 50BV30;
- 5/16" (7.9 mm): 8, 10, 12 mm (L=30 mm); AISI S2;
- 5/16" (7.9 mm): PH3, PH4 (L=30 mm); AISI S2;
- 5/16" (7.9 mm): PZ3, PZ4 (L=30 mm); AISI S2;
- 5/16" (7.9 mm): T40, T45, T50, T55, T60 (L=30 mm); AISI S2;
- 5/16" (7.9 mm): 7, 8, 10, 12, 14 mm (L=30 mm); AISI S2;
- 1/4" (6.3 mm): 4, 5.5, 6.5 mm (L=37 mm); AISI S2 / CrV 50BV30;
- 1/4" (6.3 mm): PH1, PH2 (L=37 mm); AISI S2 / CrV 50BV30;
- 1/4" (6.3 mm): PZ1, PZ2 (L=37 mm); AISI S2 / CrV 50BV30;
- 1/4" (6.3 mm): T8, T10, T15, T20, T25, T27, T30 (L=37 mm); AISI S2 / CrV 50BV30;
- 1/4" (6.3 mm): 3, 4, 5, 6 mm (L=37 mm); AISI S2 / CrV 50BV30;
- 1.5, 2, 2.5 mm; CrV 6150

YATO ®	○	
YT-38791	1/4" (6.3 mm), 1/2" (12.7 mm)	2

EN Tool set
 PL Zestaw narzędziowy
 DE Werkzeug-Satz

RU Набор инструмента

CZ Sada nářadí
 HU Szerszámkészlet
 RO Trusa de scule
 FR Jeu d'outils

IT Set di utensili
 ES Juego de herramientas
 CN 工具组套

109 PCS	1/2" 12.7mm	1/4" 6.3mm	CrV 50BV30	CrV 6150	CrV 6140
CrMo 440	S2	72T	AS-DRIVE		



- 1/2" (12.7 mm): 12, 13, 14, 15, 16, 17, 18, 19, 20, 21, 22, 24 mm (L=38 mm); 27, 30, 32 mm (L=42 mm), 1/4" (6.3 mm): 4, 4.5, 5, 5.5, 6, 7, 8, 9, 10, 11, 12, 13, 14 mm (L=25 mm); CrV 50BV30;
- 1/2" (12.7 mm): 10, 12, 13, 14, 17, 19 mm (L=76 mm), 1/4" (6.3 mm): 4, 5, 6, 7, 8, 9 mm (L=50 mm); CrV 50BV30;
- 1/2" (12.7 mm): E10, E12, E14, E16, E18, E20, E22, E24; CrV 6150;
- 1/2" (12.7 mm): (254 mm), 1/4" (6.3 mm): (152.4 mm); CrV 50BV30;
- 3/8" (9.5 mm) (F) x 1/2" (12.7 mm) (M), 3/8" (9.5 mm) (F) x 1/4" (6.3 mm) (M); CrV 50BV30;
- 1/2" (12.7 mm), 1/4" (6.3 mm); CrV 50BV30;
- 1/2" (12.7 mm): 16, 21 mm; CrV 50BV30;
- 1/2" (12.7 mm): (255 mm), 1/4" (6.3 mm): (155 mm); 72T; CrMo 440;
- 1/4" (6.3 mm): (150 mm); CrV 50BV30;
- 1/4" (6.3 mm): 4, 5.5, 6.5 mm (L=37 mm); AISI S2 / CrV 6150;
- 1/4" (6.3 mm): PH1, PH2, PH3 (L=37 mm); AISI S2 / CrV 6150;
- 1/4" (6.3 mm): PZ2, PZ3 (L=37 mm); AISI S2 / CrV 6150;
- 1/4" (6.3 mm): T8, T10, T15, T20, T25 (L=37 mm); AISI S2 / CrV 6150;
- 1/4" (6.3 mm): T10, T15, T20, T25, T40 (L=37 mm); AISI S2 / CrV 6150;
- 1/4" (6.3 mm): 3, 4, 5, 6 mm (L=37 mm); AISI S2 / CrV 6150;
- 8, 9, 10, 11, 12, 13, 14, 15, 16, 17, 18, 19 mm; CrV;
- 8x9, 10x11, 12x13, 14x15 mm; CrV 50BV30;
- 8x10, 12x13, 17x19 mm; CrV 6140;
- 3x75, 4x100, 6x150, PH1x75, PH2x100, PH3x150 mm; S2;
- 180 mm;
- 160 mm;
- 300 g

YATO ®	○	
YT-38891	1/4" (6.3 mm), 1/2" (12.7 mm)	2



























EN Tool set
PL Zestaw narzędziowy
DE Werkzeug-Satz
RU Набор инструмента



CZ Sada nářadí
HU Szerszámkészlet
RO Trusa de scule
FR Jeu d'outils

IT Set di utensili
ES Juego de herramientas
CN 工具组套

122 PCS	1/2" 12.7mm	1/4" 6.3mm	CrV 50BV30	CrV 6150
CrMo 440	S2	72T	AS-DRIVE	



-  1/2" (12.7 mm): 12, 13, 14, 15, 16, 17, 18, 19, 20, 21, 22, 24 mm (L=38 mm); 27, 30, 32 mm (L=42 mm);
- 1/4" (6.3 mm): 4, 4.5, 5, 5.5, 6, 7, 8, 9, 10, 11, 12, 13, 14 mm (L=25 mm); CrV 50BV30;
-  1/2" (12.7 mm): 10, 12, 13, 14, 17, 19 mm (L=76 mm); 1/4" (6.3 mm): 4, 5, 6, 7, 8, 9 mm (L=50 mm); CrV 50BV30;
-  1/2" (12.7 mm): E10, E12, E14, E16, E18, E20, E22, E24; CrV 6150;
-  1/2" (12.7 mm): (254 mm), 1/4" (6.3 mm): (152.4 mm); CrV 50BV30;
-  3/8" (9.5 mm) (F) x 1/2" (12.7 mm) (M), 3/8" (9.5 mm) (F) x 1/4" (6.3 mm) (M); CrV 50BV30;
-  1/2" (12.7 mm), 1/4" (6.3 mm); CrV 50BV30;
-  1/2" (12.7 mm): 16, 21 mm; CrV 50BV30;
-  1/2" (12.7 mm): (255 mm), 1/4" (6.3 mm): (155 mm); 72T; CrMo 440;
-  1/4" (6.3 mm); (150 mm); CrV 50BV30;
-  1/4" (6.3 mm) x 1/4" (6.3 mm); CrV 50BV30;
-  1/4" (6.3 mm): 3, 4, 5, 6 mm (L=25 mm); AISI S2;
-  1/4" (6.3 mm): PH0, PH1, PH2 (L=25 mm); AISI S2;
-  1/4" (6.3 mm): PZ0, PZ1, PZ2 (L=25 mm); AISI S2;
-  1/4" (6.3 mm): 4, 5.5, 6.5 mm (L=37 mm); AISI S2 / CrV 6150;
-  1/4" (6.3 mm): PH1, PH2, PH3 (L=37 mm); AISI S2 / CrV 6150;
-  1/4" (6.3 mm): PZ2, PZ3 (L=37 mm); AISI S2 / CrV 6150;
-  1/4" (6.3 mm): T8, T10, T15, T20, T25 (L=37 mm); AISI S2 / CrV 6150;
-  1/4" (6.3 mm): T10, T15, T20, T25, T40 (L=37 mm); AISI S2 / CrV 6150;
-  1/4" (6.3 mm): 3, 4, 5, 6 mm (L=37 mm); AISI S2 / CrV 6150;
-  8, 9, 10, 11, 12, 13, 14, 15, 16, 17, 18, 19 mm; CrV;
-  4x100, 6x150, PH2x100, PH3x150 mm; S2;
-  180 mm;
-  160 mm;
-  160 mm;
-  250 mm; CrV;
-  300 g;
-  2, 2.5, 3, 4, 5, 6, 7, 8, 10 mm; CrV 6150

YATO 	○	
YT-38901	1/4" (6.3 mm), 1/2" (12.7 mm)	2





















EN Tool set
PL Zestaw narzędziowy
DE Werkzeug-Satz
RU Набор инструмента



CZ Sada nářadí
HU Szerszámkészlet
RO Trusa de scule
FR Jeu d'outils

IT Set di utensili
ES Juego de herramientas
CN 工具组套

111 PCS	1/2" 12.7mm	3/8" 9.5mm	1/4" 6.3mm	CrV 50BV30	CrV 6150
CrMo 440	S2	72T	AS-DRIVE		



-  1/2" (12.7 mm): 14, 15, 16, 17, 18, 19, 20, 21, 22, 23, 24 mm (L=38 mm); 27, 30, 32 mm (L=42 mm);
- 3/8" (9.5 mm): 9, 10, 11, 12, 13, 14, 15, 16 mm (L=28 mm); 17, 18, 19 mm (L=30 mm);
- 1/4" (6.3 mm): 3.5, 4, 4.5, 5, 5.5, 6, 7, 8, 9, 10, 11, 12, 13 mm (L=25 mm); CrV 50BV30;
-  1/2" (12.7 mm): (127, 254 mm), 3/8" (9.5 mm): (76, 152.4 mm), 1/4" (6.3 mm): (50.8, 152.4 mm); CrV 50BV30;
-  3/8" (9.5 mm) (F) x 1/2" (12.7 mm) (M), 1/2" (12.7 mm) (F) x 3/8" (9.5 mm) (M),
- 3/8" (9.5 mm) (F) x 1/4" (6.3 mm) (M); CrV 50BV30;
-  1/2" (12.7 mm), 3/8" (9.5 mm), 1/4" (6.3 mm); CrV 50BV30;
-  1/2" (12.7 mm): 16, 21 mm, 3/8" (9.5 mm): 16, 21 mm; CrV 50BV30;
-  1/2" (12.7 mm): (255 mm), 3/8" (9.5 mm): (200 mm), 1/4" (6.3 mm): (155 mm); 72T; CrMo 440;
-  1/4" (6.3 mm); (150 mm); CrV 50BV30;
-  1/2" (12.7 mm) x 5/16" (7.9 mm), 3/8" (9.5 mm) x 5/16" (7.9 mm); CrV 50BV30;
-  5/16" (7.9 mm): 6, 6.5, 8 mm (L=30 mm); AISI S2;
-  5/16" (7.9 mm): PH2, PH3 (L=30 mm); AISI S2;
-  5/16" (7.9 mm): PZ2, PZ3 (L=30 mm); AISI S2;
-  5/16" (7.9 mm): T27, T30, T35, T40, T45 (L=30 mm); AISI S2;
-  5/16" (7.9 mm): 5.5, 6, 6.5 mm (L=30 mm); AISI S2;
-  1/4" (6.3 mm): 4, 5.5, 6.5 mm (L=37 mm); AISI S2 / CrV 6150;
-  1/4" (6.3 mm): PH1, PH2 (L=37 mm); AISI S2 / CrV 6150;
-  1/4" (6.3 mm): PZ1, PZ2 (L=37 mm); AISI S2 / CrV 6150;
-  1/4" (6.3 mm): T8, T10, T15, T20, T25 (L=37 mm); AISI S2 / CrV 6150;
-  1/4" (6.3 mm): T10, T15, T20, T25, T40 (L=37 mm); AISI S2 / CrV 6150;
-  1/4" (6.3 mm): 3, 4, 5, 6 mm (L=37 mm); AISI S2 / CrV 6150;
-  8, 9, 10, 11, 12, 13, 14, 15, 16, 17, 18, 19 mm; CrV;
- 1.5, 2, 2.5 mm; CrV 6150



















YATO 	○	
YT-38831	1/4" (6.3 mm), 3/8" (9.5 mm), 1/2" (12.7 mm)	2



EN Tool set
 PL Zestaw narzędziowy
 DE Werkzeug-Satz
 RU Набор инструментов
 CZ Sada nářadí
 HU Szerszámkészlet

RO Trusa de scule
 FR Jeu d'outils
 IT Set di utensili
 ES Juego de herramientas
 CN 工具组套

120 PCS	1/2" 12.7mm	3/8" 9.5mm	1/4" 6.3mm
METRIC SAE	CrV 50BV30	CrV 6150	CrMo 440
S2	72T	AS-DRIVE	



-  1/2" (12.7 mm): 20, 21, 22, 24 mm (L=38 mm); 27, 30, 32 mm (L=42 mm);
- 3/8" (9.5 mm): 9, 10, 11, 12, 13, 14, 15, 16 mm (L=28 mm); 17, 18, 19 mm (L=30 mm);
- 1/4" (6.3 mm): 4, 5, 6, 7, 8, 9, 10, 11, 12, 13 mm (L=25 mm); CrV 50BV30;
-  3/8" (9.5 mm): 13, 14, 15, 17 mm (L=63 mm); 1/4" (6.3 mm): 8, 9, 10, 12 mm (L=50 mm); CrV 50BV30;
-  1/2" (12.7 mm) x 15/16" (23.8 mm), 1/2" (12.7 mm) x 1" (25.4 mm), 1/2" (12.7 mm) x 1-1/16" (27.0 mm),
- 1/2" (12.7 mm) x 1-1/4" (31.8 mm), 3/8" (9.5 mm) x 3/8" (9.5 mm), 3/8" (9.5 mm) x 7/16" (11.1 mm),
- 3/8" (9.5 mm) x 1/2" (12.7 mm), 3/8" (9.5 mm) x 9/16" (14.3 mm), 3/8" (9.5 mm) x 5/8" (15.9 mm),
- 3/8" (9.5 mm) x 11/16" (17.5 mm), 3/8" (9.5 mm) x 3/4" (19.0 mm), 3/8" (9.5 mm) x 13/16" (20.6 mm),
- 3/8" (9.5 mm) x 7/8" (22.2 mm), 1/4" (6.3 mm) x 5/32" (4.0 mm), 1/4" (6.3 mm) x 3/16" (4.8 mm),
- 1/4" (6.3 mm) x 7/32" (5.6 mm), 1/4" (6.3 mm) x 1/4" (6.3 mm), 1/4" (6.3 mm) x 9/32" (7.1 mm),
- 1/4" (6.3 mm) x 5/16" (7.9 mm), 1/4" (6.3 mm) x 11/32" (8.7 mm), 1/4" (6.3 mm) x 3/8" (9.5 mm),
- 1/4" (6.3 mm) x 7/16" (11.1 mm), 1/4" (6.3 mm) x 1/2" (12.7 mm); CrV 50BV30;
-  1/2" (12.7 mm): 17, 19, 21, 23 mm; CrV 50BV30;
-  3/8" (9.5 mm): E8, E10, E11, E12, E14, E16, E18, E20; CrV 6150;
-  1/2" (12.7 mm): (127, 254 mm), 3/8" (9.5 mm): (76, 152.4 mm), 1/4" (6.3 mm): (50.8 mm); CrV 50BV30;
-  1/2" (12.7 mm), 3/8" (9.5 mm), 1/4" (6.3 mm); CrV 50BV30;
-  3/8" (9.5 mm): 16, 21 mm; CrV 50BV30;
-  1/2" (12.7 mm): (255 mm), 3/8" (9.5 mm): (200 mm), 1/4" (6.3 mm): (155 mm); 72T; CrMo 440;
-  1/4" (6.3 mm): (150 mm); CrV 50BV30;
-  1/4" (6.3 mm) x 1/4" (6.3 mm); CrV 50BV30;
-  1/4" (6.3 mm): T10, T15, T20, T25, T27, T30, T40 (L=25 mm); AISI S2;
-  3/8" (9.5 mm): 5.5, 6.5 mm (L=50 mm); AISI S2 / CrV 6150;
-  3/8" (9.5 mm): PH1, PH2 (L=50 mm); AISI S2 / CrV 6150;
-  3/8" (9.5 mm): PZ1, PZ2 (L=50 mm); AISI S2 / CrV 6150;
-  3/8" (9.5 mm): T20, T30, T40, T45, T50, T55, T60 (L=50 mm); AISI S2 / CrV 6150;
-  3/8" (9.5 mm): 3, 4, 5, 6 mm (L=50 mm); AISI S2 / CrV 6150;
-  8, 9, 10, 11, 12, 13, 14, 17, 18, 19 mm; CrV



























YATO 		
YT-38801	1/4" (6.3 mm), 3/8" (9.5 mm), 1/2" (12.7 mm)	2



EN Tool set
 PL Zestaw narzędziowy
 DE Werkzeug-Satz
 RU Набор инструментов
 CZ Sada nářadí
 HU Szerszámkészlet

RO Trusa de scule
 FR Jeu d'outils
 IT Set di utensili
 ES Juego de herramientas
 CN 工具组套

126 PCS	1/2" 12.7mm	3/8" 9.5mm	1/4" 6.3mm
CrV 50BV30	CrV 6150	CrV 6140	S2
72T	AS-DRIVE		



-  1/2" (12.7 mm): 20, 21, 22, 24 mm (L=38 mm); 27, 30, 32 mm (L=42 mm);
- 3/8" (9.5 mm): 9, 10, 11, 12, 13, 14, 15, 16 mm (L=28 mm); 17, 18, 19 mm (L=30 mm);
- 1/4" (6.3 mm): 4, 4.5, 5, 5.5, 6, 7, 8, 9, 10, 11, 12, 13 mm (L=25 mm); CrV 50BV30;
-  3/8" (9.5 mm): 13, 14, 15, 17 mm (L=63 mm); 1/4" (6.3 mm): 8, 9, 10, 12 (L=50 mm); CrV 50BV30;
-  3/8" (9.5 mm): E8, E10, E11, E12, E14, E16, E18, E20; CrV 6150;
-  1/2" (12.7 mm): (127, 254 mm), 3/8" (9.5 mm): (76, 152.4 mm), 1/4" (6.3 mm): (50.8 mm); CrV 50BV30;
-  3/8" (9.5 mm) (F) x 1/2" (12.7 mm) (M); CrV 50BV30; 1/2" (12.7 mm), 3/8" (9.5 mm), 1/4" (6.3 mm); CrV 50BV30;
-  3/8" (9.5 mm): 16, 21 mm; CrV 50BV30;
-  1/2" (12.7 mm): (255 mm), 3/8" (9.5 mm): (200 mm), 1/4" (6.3 mm): (155 mm); 72T; CrV 6140;
-  1/4" (6.3 mm): (150 mm); CrV 50BV30;
-  1/2" (12.7 mm) (F) x 3/8" (9.5 mm) (M), 3/8" (9.5 mm) (F) x 1/2" (12.7 mm) (M), 3/8" (9.5 mm) (F) x 1/4" (6.3 mm) (M); CrV 50BV30;
-  1/4" (6.3 mm) x 1/4" (6.3 mm); CrV 6140;
-  1/4" (6.3 mm): 4, 5, 6.5 mm (L=25 mm); AISI S2;
-  1/4" (6.3 mm): PH1, PH3 (L=25 mm); AISI S2;
-  1/4" (6.3 mm): PZ1, PZ2 (L=25 mm); AISI S2;
-  1/4" (6.3 mm): T10, T15, T20, T25, T27, T30, T40 (L=25 mm); AISI S2;
-  1/4" (6.3 mm): 3, 4, 5, 6 mm (L=25 mm); AISI S2;
-  3/8" (9.5 mm): 5.5, 6.5 mm (L=50 mm); AISI S2 / CrV 6150;
-  3/8" (9.5 mm): PH1, PH2 x2 (L=50 mm); AISI S2 / CrV 6150;
-  3/8" (9.5 mm): T20, T30, T40 (L=50 mm), 1/2" (12.7 mm): T52 (L=125 mm); AISI S2 / CrV 6150;
-  3/8" (9.5 mm): T45, T50, T55, T60 (L=50 mm); AISI S2 / CrV 6150;
-  3/8" (9.5 mm): 3, 4, 5, 6, 7 mm (L=50 mm); AISI S2 / CrV 6150;
-  8, 10, 12, 13, 14, 16, 17, 18, 19 mm; CrV;
-  8x10 mm, 11x12 mm; CrV 6140;
-  6x100 mm, PH2x100 mm; CrV 6150;
-  6-24 V;
-  150 mm;
-  1/2" (12.7 mm), 3/8" (9.5 mm): 63-120 mm; CrV;
-  1.5, 2, 2.5, 3, 4, 5, 6, 8, 10 mm; S2

YATO 		
YT-38875	1/4" (6.3 mm), 3/8" (9.5 mm), 1/2" (12.7 mm)	2

EN Tool set
 PL Zestaw narzędziowy
 DE Werkzeug-Satz
 RU Набор инструмента
 CZ Sada nářadí
 HU Szerszámkészlet

RO Trusa de scule
 FR Jeu d'outils
 IT Set di utensili
 ES Juego de herramientas
 CN 工具组套

128 PCS
 1/2" 12.7mm
 3/8" 9.5mm
 1/4" 6.3mm
 CrV 50BV30
 CrV 6150
 CrMo 440
 S2
 72T
 AS-DRIVE



2



- 1/2" (12.7 mm): 14, 15, 16, 17, 18, 19, 20, 21, 22, 24 mm (L=38 mm); 27, 30, 32 mm (L=42 mm),
- 3/8" (9.5 mm): 10, 11, 12, 13, 14, 15, 16 mm (L=28 mm); 17, 18 mm (L=30 mm),
- 1/4" (6.3 mm): 6, 7, 8, 9, 10, 11, 12, 13 mm (L=25 mm); CrV 50BV30;
- 1/2" (12.7 mm): 17, 18, 19, 22 mm (L=76 mm); 3/8" (9.5 mm): 8, 10, 12, 13, 14, 15 mm (L=63 mm),
- 1/4" (6.3 mm): 6, 7, 8, 10, 12, 13 mm (L=50 mm); CrV 50BV30;
- 1/2" (12.7 mm): 17, 19, 21, 22 mm; CrV 50BV30;
- 3/8" (9.5 mm): E8, E10, E11, E12, E14, E16; CrV 6150;
- 1/2" (12.7 mm): (127, 254 mm), 3/8" (9.5 mm): (152.4, 254 mm), 1/4" (6.3 mm): (50.8, 101.6 mm); CrV 50BV30;
- 3/8" (9.5 mm) (F) x 1/2" (12.7 mm) (M); CrV 50BV30;
- 1/2" (12.7 mm), 3/8" (9.5 mm), 1/4" (6.3 mm); CrV 50BV30;
- 1/2" (12.7 mm): 16, 21 mm; CrV 50BV30;
- 3/8" (9.5 mm): (198 mm), 1/4" (6.3 mm): (152.4 mm); CrV 50BV30;
- 1/2" (12.7 mm): (255 mm), 3/8" (9.5 mm): (200 mm), 1/4" (6.3 mm): (155 mm); 72T; CrMo 440;
- 1/4" (6.3 mm): (150 mm); CrV 50BV30;
- 1/2" (12.7 mm): (250 mm); CrV 50BV30;
- 3/8" (9.5 mm) x 5/16" (7.9 mm); CrV 50BV30;
- 1/2" (12.7 mm) x 3/8" (9.5 mm), 3/8" (9.5 mm) x 1/4" (6.3 mm); CrV 50BV30;
- 1/4" (6.3 mm) x 1/4" (6.3 mm); CrV 50BV30;
- 3/8" (9.5 mm): 5.5, 6.5 mm (L=70 mm); AISI S2;
- 3/8" (9.5 mm): PH1, PH2, PH3 (L=70 mm); AISI S2;
- 3/8" (9.5 mm): T20, T30, T40, T45, T50, T55 (L=70 mm); AISI S2;
- 3/8" (9.5 mm): 6, 7, 8, 10, 12 mm (L=70 mm); AISI S2;
- 1/4" (6.3 mm): PZ1, PZ2 (L=25 mm); AISI S2;
- 1/4" (6.3 mm): T8, T10 (L=25 mm); AISI S2;
- 1/4" (6.3 mm): 4, 5.5, 6.5 mm (L=37 mm); AISI S2 / CrV 6150;
- 1/4" (6.3 mm): PH1, PH2 (L=37 mm); AISI S2 / CrV 6150;
- 1/4" (6.3 mm): T8, T10, T15, T20, T25, T30, T40 (L=37 mm); AISI S2 / CrV 6150;
- 1/4" (6.3 mm): 3, 4, 5, 6 mm (L=37 mm); AISI S2 / CrV 6150;
- 8, 10, 12, 13, 14, 15, 16, 17, 18, 19 mm; CrV;
- 1.5, 2, 2.5 mm; CrV 6150

YATO	O	☐
YT-38872	1/4" (6.3 mm), 3/8" (9.5 mm), 1/2" (12.7 mm)	2

EN Tool set
 PL Zestaw narzędziowy
 DE Werkzeug-Satz
 RU Набор инструмента
 CZ Sada nářadí
 HU Szerszámkészlet

RO Trusa de scule
 FR Jeu d'outils
 IT Set di utensili
 ES Juego de herramientas
 CN 工具组套

129 PCS
 1/2" 12.7mm
 3/8" 9.5mm
 1/4" 6.3mm
 CrV 50BV30
 CrV 6150
 CrMo 440
 S2

72T
 AS-DRIVE



- 1/2" (12.7 mm): 12, 13, 14, 15, 16, 17, 18, 19, 20, 21, 22, 24 mm (L=38 mm); 27, 30, 32 mm (L=42 mm),
- 3/8" (9.5 mm): 10, 11, 12, 13, 14, 15, 16 mm (L=28 mm); 17, 18, 19 mm (L=30 mm),
- 1/4" (6.3 mm): 4, 4.5, 5, 5.5, 6, 7, 8, 9, 10, 11, 12, 13, 14 mm (L=25 mm); CrV 50BV30;
- 1/2" (12.7 mm): 10, 12, 13, 14, 17, 19 mm (L=76 mm), 1/4" (6.3 mm): 4, 5, 6, 7, 8, 9 mm (L=50 mm); CrV 50BV30;
- 1/2" (12.7 mm): 17, 19, 21, 23 mm; CrV 50BV30;
- 3/8" (9.5 mm): E8, E10, E11, E12, E14, E16, E18, E20; CrV 6150;
- 1/2" (12.7 mm): (127, 254 mm), 3/8" (9.5 mm): (76, 152.4 mm), 1/4" (6.3 mm): (50.8 mm); CrV 50BV30;
- 1/2" (12.7 mm), 3/8" (9.5 mm), 1/4" (6.3 mm); CrV 50BV30;
- 3/8" (9.5 mm): 16, 21 mm; CrV 50BV30;
- 1/2" (12.7 mm): (255 mm), 3/8" (9.5 mm): (200 mm), 1/4" (6.3 mm): (155 mm); 72T; CrMo 440;
- 1/4" (6.3 mm): (150 mm); CrV 50BV30;
- 3/8" (9.5 mm): 4, 5.5, 6.5 mm (L=50 mm); AISI S2 / CrV 6150;
- 3/8" (9.5 mm): PH1, PH2, PH3 (L=50 mm); AISI S2 / CrV 6150;
- 3/8" (9.5 mm): PZ1, PZ2, PZ3 (L=50 mm); AISI S2 / CrV 6150;
- 3/8" (9.5 mm): T20, T30, T40, T45, T50, T55, T60 (L=50 mm); AISI S2 / CrV 6150;
- 3/8" (9.5 mm): 3, 4, 5, 6, 8, 10 mm (L=50 mm); AISI S2 / CrV 6150;
- 8, 10, 11, 12, 13, 14, 15, 16, 17, 18, 19, 22 mm; CrV;
- 3x75, 4x100, 6x150, PH1x75, PH2x100, PH3x150 mm; S2;
- 160 mm;
- 160 mm;
- 160 mm;
- 1.5, 2, 2.5, 3, 4, 5, 6, 7, 8, 10 mm; CrV 6150

YATO	O	☐
YT-38881	1/4" (6.3 mm), 3/8" (9.5 mm), 1/2" (12.7 mm)	2

EN Tool set
 PL Zestaw narzędziowy
 DE Werkzeug-Satz

RU Набор инструмента
 CZ Sada nářadí
 HU Szerszámkészlet

RO Trusa de scule
 FR Jeu d'outils
 IT Set di utensili

ES Juego de herramientas
 CN 工具组套

150 PCS	1/2" 12.7 mm	3/8" 9.5 mm	1/4" 6.3 mm
METRIC SAE	CrV 50BV30	CrV 6150	CrV 6140
CrMo 440	S2	72T	AS-DRIVE



- 1/2" (12.7 mm): 20, 21, 22, 24 mm (L=38 mm); 27, 30, 32 mm (L=42 mm), 3/8" (9.5 mm): 9, 10, 11, 12, 13, 14, 15, 16 mm (L=28 mm); 17, 18, 19 mm (L=30 mm), 1/4" (6.3 mm): 4, 5, 6, 7, 8, 9, 10, 11, 12, 13 mm (L=25 mm); CrV 50BV30;
- 1/2" (12.7 mm): 10, 12, 13, 14, 17, 19 mm (L=76 mm), 3/8" (9.5 mm): 10, 11, 12, 13, 14, 15 mm (L=63 mm), 1/4" (6.3 mm): 4, 5, 6, 7, 8, 9 mm (L=50 mm); CrV 50BV30;
- 1/2" (12.7 mm) x 15/16" (23.8 mm), 1/2" (12.7 mm) x 1" (25.4 mm), 1/2" (12.7 mm) x 1-1/16" (27.0 mm), 1/2" (12.7 mm) x 1-1/4" (31.8 mm), 3/8" (9.5 mm) x 3/8" (9.5 mm), 3/8" (9.5 mm) x 7/16" (11.1 mm), 3/8" (9.5 mm) x 1/2" (12.7 mm), 3/8" (9.5 mm) x 9/16" (14.3 mm), 3/8" (9.5 mm) x 5/8" (15.9 mm), 3/8" (9.5 mm) x 11/16" (17.5 mm), 3/8" (9.5 mm) x 3/4" (19.0 mm), 3/8" (9.5 mm) x 13/16" (20.6 mm), 3/8" (9.5 mm) x 7/8" (22.2 mm), 1/4" (6.3 mm) x 5/32" (4.0 mm), 1/4" (6.3 mm) x 3/16" (4.8 mm), 1/4" (6.3 mm) x 7/32" (5.6 mm), 1/4" (6.3 mm) x 1/4" (6.3 mm), 1/4" (6.3 mm) x 9/32" (7.1 mm), 1/4" (6.3 mm) x 5/16" (7.9 mm), 1/4" (6.3 mm) x 11/32" (8.7 mm), 1/4" (6.3 mm) x 3/8" (9.5 mm), 1/4" (6.3 mm) x 7/16" (11.1 mm), 1/4" (6.3 mm) x 1/2" (12.7 mm); CrV 50BV30;
- 1/2" (12.7 mm): 17, 19, 21, 23 mm; CrV 50BV30;
- 3/8" (9.5 mm): E8, E10, E11, E12, E14, E16, E18, E20; CrV 6150;
- 1/2" (12.7 mm): (127, 254 mm), 3/8" (9.5 mm): (76, 152.4 mm), 1/4" (6.3 mm): (50.8 mm); CrV 50BV30;
- 1/2" (12.7 mm), 3/8" (9.5 mm), 1/4" (6.3 mm); CrV 50BV30;

- 3/8" (9.5 mm): 16, 21 mm; CrV 50BV30;
- 1/2" (12.7 mm): (255 mm), 3/8" (9.5 mm): (200 mm), 1/4" (6.3 mm): (155 mm); 72T; CrMo 440;
- 1/4" (6.3 mm): (150 mm); CrV 50BV30;
- 1/4" (6.3 mm) x 1/4" (6.3 mm); CrV 50BV30;
- 1/4" (6.3 mm): T10, T15, T20, T25, T27, T30, T40 (L=25 mm); AISI S2;
- 3/8" (9.5 mm): 4, 5.5, 6.5 mm (L=50 mm); AISI S2 / CrV 6150;
- 3/8" (9.5 mm): PH1, PH2, PH3 (L=50 mm); AISI S2 / CrV 6150;
- 3/8" (9.5 mm): PZ1, PZ2, PZ3 (L=50 mm); AISI S2 / CrV 6150;
- 3/8" (9.5 mm): T20, T30, T40, T45, T50, T55, T60 (L=50 mm); AISI S2 / CrV 6150;
- 3/8" (9.5 mm): 3, 4, 5, 6, 8, 10 mm (L=50 mm); AISI S2 / CrV 6150;
- 8, 9, 10, 11, 12, 13, 14, 15, 16, 17, 18, 19 mm; CrV;
- 8x10, 12x13, 17x19 mm; CrV 6140;
- 1.5, 2, 2.5, 3, 4, 5, 6, 7, 8, 10 mm; CrV 6150

YATO		
YT-38811	1/4" (6.3 mm), 3/8" (9.5 mm), 1/2" (12.7 mm)	2

EN Tool set
PL Zestaw narzędziowy
DE Werkzeug-Satz

RU Набор инструмента
CZ Sada náradí
HU Szerszámkészlet

RO Trusa de scule
FR Jeu d'outils
IT Set di utensili

ES Juego de herramientas
CN 工具组套

173 PCS	1/2" 12.7mm	3/8" 9.5mm	1/4" 6.3mm
CrV 50BV30	CrV 6150	CrV 40	CrMo 440
S2	72T	AS-DRIVE	

2



- 1/2" (12.7 mm): 10, 11, 12, 13, 14, 15, 16, 17, 18, 19, 20, 21, 22, 23, 24 mm (L=38 mm); 27, 30, 32 mm (L=42 mm); 3/8" (9.5 mm): 10, 11, 12, 13, 14, 15, 16 mm (L=28 mm); 17, 18, 19 mm (L=30 mm); 1/4" (6.3 mm): 4, 4.5, 5, 5.5, 6, 7, 8, 9, 10, 11, 12, 13, 14 mm (L=25 mm); CrV 50BV30;
- 1/2" (12.7 mm): 16, 17, 18, 19, 22 mm (L=76 mm); 3/8" (9.5 mm): 10, 11, 12, 13, 14, 15 mm (L=63 mm); 1/4" (6.3 mm): 4, 5, 6, 7, 8, 9, 10 mm (L=50 mm); CrV 50BV30;
- 1/2" (12.7 mm): E18, E20, E24, 3/8" (9.5 mm): E10, E11, E12, E14, E16, 1/4" (6.3 mm): E4, E5, E6, E7, E8; CrV 6150;
- 1/2" (12.7 mm): (127, 254 mm), 3/8" (9.5 mm): (152.4 mm), 1/4" (6.3 mm): (50.8, 101.6 mm); CrV 50BV30;
- 3/8" (9.5 mm) (F) x 1/2" (12.7 mm); CrV 50BV30;
- 1/2" (12.7 mm), 3/8" (9.5 mm), 1/4" (6.3 mm); CrV 50BV30;
- 1/2" (12.7 mm): 16, 21 mm, 3/8" (9.5 mm): 18 mm; CrV 50BV30;
- 1/4" (6.3 mm); (152.4 mm); CrV 40;
- 1/2" (12.7 mm); (255 mm), 3/8" (9.5 mm); (200 mm), 1/4" (6.3 mm); (155 mm); 72T; CrMo 440;
- 1/4" (6.3 mm); (150 mm); CrV 50BV30;
- 1/2" (12.7 mm) x 5/16" (7.9 mm), 3/8" (9.5 mm) x 5/16" (7.9 mm); CrV 50BV30;
- 1/4" (6.3 mm) x 1/4" (6.3 mm); CrV 50BV30;
- 5/16" (7.9 mm): 8, 10, 12 mm (L=30 mm); AISI S2;

- 5/16" (7.9 mm): PH3, PH4 (L=30 mm); AISI S2;
- 5/16" (7.9 mm): PZ3, PZ4 (L=30 mm); AISI S2;
- 5/16" (7.9 mm): T40, T45, T50, T55, T60, T70 (L=30 mm); AISI S2;
- 5/16" (7.9 mm): T40, T45, T50, T55, T60, T70 (L=30 mm); AISI S2;
- 5/16" (7.9 mm): 7, 8, 10, 12, 14 mm (L=30 mm); AISI S2;
- 1/4" (6.3 mm): T5, T6, T7 (L=25 mm); AISI S2;
- 1/4" (6.3 mm): T7, T10, T15, T20, T25, T27, T30, T40, T45 (L=25 mm); AISI S2;
- 1/4" (6.3 mm): M5, M6, M8 (L=25 mm); AISI S2;
- 1/4" (6.3 mm): RM5, RM6, RM7, RM8, RM9 (L=25 mm); AISI S2;
- 1/4" (6.3 mm) 4, 5.5, 6.5, 7 mm (L=37 mm); AISI S2 / CrV 6150;
- 1/4" (6.3 mm): PH0, PH1, PH2 (L=37 mm); AISI S2 / CrV 6150;
- 1/4" (6.3 mm) PZ0, PZ1, PZ2 (L=37 mm); AISI S2 / CrV 6150;
- 1/4" (6.3 mm): T8, T9, T10, T15, T20, T25, T27, T30 (L=37 mm); AISI S2 / CrV 6150;
- 1/4" (6.3 mm): T8, T9, T10, T15, T20, T25, T27, T30 (L=37 mm); AISI S2 / CrV 6150;
- 1/4" (6.3 mm): 3, 4, 5, 6 mm (L=37 mm); AISI S2 / CrV 6150;
- 1.25, 1.5, 2, 2.5, 3, 4, 5 mm; CrV 6150

YATO		
YT-38931	1/4" (6.3 mm), 3/8" (9.5 mm), 1/2" (12.7 mm)	2

EN Tool set
 PL Zestaw narzędziowy
 DE Werkzeug-Satz

RU Набор инструмента
 CZ Sada nářadí
 HU Szerszámkészlet

RO Trusa de scule
 FR Jeu d'outils
 IT Set di utensili

ES Juego de herramientas
 CN 工具组套

216 PCS	1/2" 12,7mm	3/8" 9,5mm	1/4" 6,3mm
CrV 50BV30	CrV 6150	CrV 40	CrMo 440
S2	72T	AS-DRIVE	



- 1/2" (12.7 mm): 10, 11, 12, 13, 14, 15, 17, 19, 20, 21, 22, 24 mm (L=38 mm); 27, 30, 32 mm (L=42 mm);
- 3/8" (9.5 mm): 10, 11, 12, 13, 14, 15, 16 mm (L=28 mm); 17, 18, 19 mm (L=30 mm);
- 1/4" (6.3 mm): 4, 4.5, 5, 5.5, 6, 7, 8, 9, 10, 11, 12, 13, 14 mm (L=25 mm); CrV 50BV30;
- 1/2" (12.7 mm): 16, 17, 18, 19, 22 mm (L=76 mm); 3/8" (9.5 mm): 10, 11, 12, 13, 14, 15 mm (L=63 mm);
- 1/4" (6.3 mm): 4, 5, 6, 7, 8, 9, 10 mm (L=50 mm); CrV 50BV30;
- 1/2" (12.7 mm): E20, E22, E24, 3/8" (9.5 mm): E10, E11, E12, E14, E16, E18,
- 1/4" (6.3 mm): E4, E5, E6, E7, E8; CrV 50BV30;
- 1/2" (12.7 mm): (127, 254 mm), 3/8" (9.5 mm): (125 mm), 1/4" (6.3 mm): (50.8, 101.6 mm); CrV 50BV30;
- 1/2" (12.7 mm), 3/8" (9.5 mm), 1/4" (6.3 mm); CrV 50BV30;
- 1/2" (12.7 mm): 16, 21 mm, 3/8" (9.5 mm): 18 mm; CrV 50BV30;
- 1/2" (12.7 mm); (255 mm), 1/4" (6.3 mm); (152.4 mm); CrV 40;
- 1/2" (12.7 mm); (255 mm), 3/8" (9.5 mm); (200 mm), 1/4" (6.3 mm); (155 mm); 72T; CrMo 440;
- 1/4" (6.3 mm); (150 mm); CrV 50BV30;
- 1/4" (6.3 mm); (200 mm);
- 1/2" (12.7 mm) x 5/16" (7.9 mm), 3/8" (9.5 mm) x 5/16" (7.9 mm); CrV 50BV30;
- 1/4" (6.3 mm) x 1/4" (6.3 mm); CrV 50BV30;
- 5/16" (7.9 mm): 6, 6.5, 8 mm (L=30 mm); AISI S2;
- 5/16" (7.9 mm): PH3, PH4 (L=30 mm); AISI S2;
- 5/16" (7.9 mm): PZ3, PZ4 (L=30 mm); AISI S2;
- 5/16" (7.9 mm): T25, T27, T30, T35, T40 x2, T45, T50 (L=30 mm); AISI S2;
- 5/16" (7.9 mm): T27, T30, T35, T40, T45, T50 (L=30 mm); AISI S2;
- 5/16" (7.9 mm): 5.5, 6, 6.5, 7, 8 mm (L=30 mm); AISI S2;

- 5/16" (7.9 mm): M5, M6, M8, M10 (L=30 mm); AISI S2;
- 1/4" (6.3 mm): 4, 5.5, 6.5 mm (L=25 mm); AISI S2;
- 1/4" (6.3 mm): PH1, PH2 (L=25 mm); AISI S2;
- 1/4" (6.3 mm): PZ1, PZ2 (L=25 mm); AISI S2;
- 1/4" (6.3 mm): T8, T10, T15, T20, T25 (L=25 mm); AISI S2;
- 1/4" (6.3 mm): T8, T10 x2, T15 x2, T20 x2, T25 x2, T40 (L=25 mm); AISI S2;
- 1/4" (6.3 mm): 3, 4, 5, 6 mm (L=25 mm); AISI S2;
- 1/4" (6.3 mm): 3, 4, 5, 6 mm (L=25 mm); AISI S2;
- 1/4" (6.3 mm): M5, M6, M8 (L=25 mm); AISI S2;
- 1/4" (6.3 mm): S1, S2 (L=25 mm); AISI S2;
- 1/4" (6.3 mm): 1, 2, 3 mm (L=25 mm); AISI S2;
- 1/4" (6.3 mm): 6, 8, 10 mm (L=25 mm); AISI S2;
- 1/4" (6.3 mm): 4, 6, 8 mm (L=25 mm); AISI S2;
- 1/2" (12.7 mm): T55, T60 (L=50 mm); AISI S2 / CrV 50BV30;
- 1/4" (6.3 mm): 6, 6.5, 8 mm (L=37 mm); AISI S2 / CrV 50BV30;
- 1/4" (6.3 mm): PH3, PH4 (L=37 mm); AISI S2 / CrV 50BV30;
- 1/4" (6.3 mm): PZ3, PZ4 (L=37 mm); AISI S2 / CrV 50BV30;
- 1/4" (6.3 mm): T25, T27, T30, T35, T40 x2, T45, T50 (L=37 mm); AISI S2 / CrV 50BV30;
- 1/4" (6.3 mm): T27, T30, T35, T40, T45, T50 (L=37 mm); AISI S2 / CrV 50BV30;
- 1/4" (6.3 mm): 5.5, 6, 6.5, 7, 8 mm (L=37 mm); AISI S2 / CrV 50BV30;
- 1/4" (6.3 mm): M5, M6, M8, M10 (L=37 mm); AISI S2 / CrV 50BV30;
- 8, 10, 11, 12, 13, 14, 15, 16, 17, 18, 19, 22 mm; CrV;
- 1.27, 1.5, 2, 2.5, 3, 4, 5 mm; CrV 6150

YATO		
YT-38841	1/4" (6.3 mm), 3/8" (9.5 mm), 1/2" (12.7 mm)	2

EN Tool set
PL Zestaw narzędziowy
DE Werkzeug-Satz
RU Набор инструмента
CZ Sada nářadí
HU Szerszámkészlet
RO Trusa de scule
FR Jeu d'outils
IT Set di utensili
ES Juego de herramientas
CN 工具组套

225 PCS	1/2" 12.7mm	3/8" 9.5mm	1/4" 6.3mm
METRIC SAE	CrV 50BV30	CrV 6150	CrV 6140
CrV 40	CrMo 440	S2	72T
AS-DRIVE			

2



- 1/2" (12.7 mm): 10, 13, 15, 16, 17, 18, 19, 20, 21, 22, 23, 24 mm (L=38 mm); 27, 30, 32 mm (L=42 mm);
- 3/8" (9.5 mm): 10, 11, 12, 13, 14, 15, 16 mm (L=28 mm); 17, 18, 19 mm (L=30 mm);
- 1/4" (6.3 mm): 3.5, 4, 4.5, 5, 5.5, 6, 7, 8, 9, 10, 11, 12, 13, 14 mm (L=25 mm); CrV 50BV30;
- 1/2" (12.7 mm): 10, 11, 12, 13, 14, 15, 17, 19, 21 mm (L=76 mm);
- 3/8" (9.5 mm): 6, 7, 8, 9, 10 mm (L=63 mm); CrV 50BV30;
- 1/2" (12.7 mm) x 7/16" (11.1 mm), 1/2" (12.7 mm) x 1/2" (12.7 mm), 1/2" (12.7 mm) x 9/16" (14.3 mm),
- 1/2" (12.7 mm) x 5/8" (15.9 mm), 1/2" (12.7 mm) x 11/16" (17.5 mm), 1/2" (12.7 mm) x 3/4" (19.0 mm),
- 1/2" (12.7 mm) x 13/16" (20.6 mm), 1/2" (12.7 mm) x 7/8" (22.2 mm), 1/4" (6.3 mm) x 1/4" (6.3 mm),
- 1/4" (6.3 mm) x 9/32" (7.1 mm), 1/4" (6.3 mm) x 5/16" (7.9 mm), 1/4" (6.3 mm) x 11/32" (8.7 mm),
- 1/4" (6.3 mm) x 3/8" (9.5 mm); CrV 50BV30;
- 1/2" (12.7 mm): 17, 19, 21 mm; CrV 50BV30;
- 1/2" (12.7 mm): E16, E18, E20, E22, E24, 3/8" (9.5 mm): E10, E11, E12, E14,
- 1/4" (6.3 mm): E4, E5, E6, E7, E8; CrV 6150;
- 1/2" (12.7 mm): (127, 254 mm), 3/8" (9.5 mm): (76, 254 mm), 1/4" (6.3 mm): (50.8, 101.6 mm); CrV 50BV30;
- 3/8" (9.5 mm) (F) x 1/2" (12.7 mm) (M), 1/2" (12.7 mm) (F) x 3/8" (9.5 mm) (M); CrV 50BV30;
- 1/2" (12.7 mm), 3/8" (9.5 mm), 1/4" (6.3 mm); CrV 50BV30;
- 1/2" (12.7 mm): 16, 21 mm (L=64 mm); 3/8" (9.5 mm): 18 mm (L=63 mm); CrV 50BV30;
- 1/4" (6.3 mm): (152.4 mm); CrV 40;
- 1/2" (12.7 mm); (255 mm), 3/8" (9.5 mm); (200 mm), 1/4" (6.3 mm); (155 mm); 72T; CrMo 440;
- 1/4" (6.3 mm); (150 mm); CrV 50BV30;
- 1/4" (6.3 mm); (200 mm); CrV 6140;
- 1/2" (12.7 mm) x 5/16" (7.9 mm), 3/8" (9.5 mm) x 5/16" (7.9 mm), 3/8" (9.5 mm) x 1/4" (6.3 mm); CrV 50BV30;
- 1/4" (6.3 mm) x 1/4" (6.3 mm); CrV 50BV30;
- 1/4" (6.3 mm) x 3/8" (9.5 mm) (L=50 mm), 1/4" (6.3 mm) x 1/4" (6.3 mm) (L=50 mm), 1/4" (6.3 mm) x 1/4" (6.3 mm) (L=50 mm); CrV 50BV30;

- (6.3 mm) (L=25 mm); CrV 50BV30;
- 1/4" (6.3 mm) (L=60 mm);
- 5/16" (7.9 mm): T20, T25, T27, T30, T40, T45, T50, T55 (L=75 mm); AISI S2;
- 5/16" (7.9 mm): 8, 10 mm (L=30 mm); AISI S2;
- 5/16" (7.9 mm): PH3, PH4 (L=30 mm); AISI S2;
- 5/16" (7.9 mm): PZ3, PZ4 (L=30 mm); AISI S2;
- 5/16" (7.9 mm): T40, T45, T50, T55, T60, T70 (L=30 mm); AISI S2;
- 5/16" (7.9 mm): T40, T45, T50, T55, T60, T70 (L=30 mm); AISI S2;
- 5/16" (7.9 mm): 10, 12, 14 mm (L=30 mm); AISI S2;
- 1/4" (6.3 mm): 3, 4, 5.5, 6.5, 7, 8, 9 mm (L=25 mm); AISI S2;
- 1/4" (6.3 mm): PH0, PH1, PH2, PH3 (L=25 mm); AISI S2;
- 1/4" (6.3 mm): PZ0, PZ1, PZ2, PZ3 (L=25 mm); AISI S2;
- 1/4" (6.3 mm): T8, T9, T10, T15, T20, T25, T27, T30 (L=25 mm); AISI S2;
- 1/4" (6.3 mm): T8, T9, T10, T15, T20, T25, T27, T30 (L=25 mm); AISI S2;
- 1/4" (6.3 mm): 3, 4, 5, 6, 7, 8 mm; (L=25 mm); AISI S2;
- 1/4" (6.3 mm): 3, 4, 5, 6, 7, 8 mm (L=25 mm); AISI S2;
- 1/4" (6.3 mm): 4, 5, 6, 7, 8 mm (L=25 mm); AISI S2;
- 1/4" (6.3 mm): 1, 2, 3, 4 (L=25 mm); AISI S2;
- 1/4" (6.3 mm): 6, 8, 10 (L=25 mm); AISI S2;
- 1/4" (6.3 mm): 4, 6, 8, 10 mm (L=25 mm); AISI S2;
- 8, 9, 10, 11, 12, 13, 14, 15, 17, 19, 22 mm; CrV;
- 6x38, PH2X38; S2;
- 180 mm;
- 250 mm; CrV;
- 2, 2.5, 3, 4, 5, 6, 7, 8, 10, 12 mm; CrV 6150

YATO		
YT-38941	1/4" (6.3 mm), 3/8" (9.5 mm), 1/2" (12.7 mm)	2

EN Tool set
 PL Zestaw narzędziowy
 DE Werkzeug-Satz

RU Набор инструмента
 CZ Sada nářadí
 HU Szerszámkészlet







RO Trusa de scule
 FR Jeu d'outils
 IT Set di utensili

ES Juego de herramientas
 CN 工具组套

23 PCS
 1/4" 6.3 mm
 CrV 50BV30

CrV 6140
 72T
 AS-DRIVE



-  1/4" (6.3 mm): 4, 5, 6, 7, 8, 9, 10, 12, 13 mm (L=25 mm); CrV 50BV30;
-  1/4" (6.3 mm): 4, 5, 6, 7, 8, 9, 10, 12, 13 mm (L=50 mm); CrV 50BV30;
-  1/4" (6.3 mm): (50.8, 152.4 mm); CrV 50BV30;
-  1/4" (6.3 mm); CrV 50BV30;
-  1/4" (6.3 mm); (127 mm); 72T; CrV 6140;
-  1/4" (6.3 mm); (150 mm); CrV 50BV30

YATO	O	
YT-14421	1/4" (6.3 mm)	10

EN Go through socket set
 PL Zestaw nasadek przelotowych z grzechotką
 DE Ratschensteckschlüsselsatz

RU Набор проходных головок с трещоткой
 CZ Sada násadových koncovek s ráčnou
 HU Dugókulcs készlet racsníval

RO Set tubulare pt. suruburi lungi
 FR Jeu de douilles traversantes avec cliquet
 IT Set di bussole con chiave a cricchetto













ES Juego de puntas de paso de trinqueta
 CN 穿心套筒组套

29 PCS
 1/4" 6.3 mm

CrV 50BV30
 S2
 72T

QUICK RELEASE SZYBKO-ZŁĄCZE



-  4, 5, 5.5, 6, 7, 8, 9, 10, 11, 12, 13 mm; CrV 50BV30;
-  1/4" (6.3 mm); (L=100 mm); CrV 50BV30;
-  1/4" (6.3 mm); CrV 50BV30;
-  (L=142 mm); 72T; CrV 50BV30;
-  1/4" (6.3 mm); CrV 50BV30;
-  1/4" (6.3 mm); CrV 50BV30;
-  1/4" (6.3 mm) x 1/4" (6.3 mm); CrV 50BV30;
-  1/4" (6.3 mm); CrV 50BV30;
-  (L=50 mm); CrV 50BV30;
-  1/4" (6.3 mm); 4, 5, 7 mm; S2;
-  1/4" (6.3 mm); PH1, PH2; S2;
-  1/4" (6.3 mm); PZ1, PZ2; S2;
-  1/4" (6.3 mm); T10, T15, T20; S2

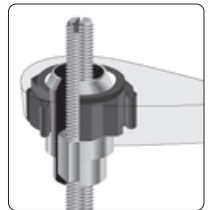

YATO	O	
YT-38650	1/4" (6.3 mm)	20

EN Tool set
 PL Zestaw narzędziowy
 DE Werkzeug-Satz

RU Набор инструмента
 CZ Sada nářadí
 HU Szerszámkészlet







RO Trusa de scule
 FR Jeu d'outils
 IT Set di utensili

ES Juego de herramientas
 CN 工具组套

25 PCS
 1/2" 12.7 mm
 CrV 50BV30

CrV 6140
 72T
 AS-DRIVE



-  1/2" (12.7 mm): 10, 11, 12, 13, 14, 15, 16, 17, 18, 19, 20, 21, 22, 23, 24 mm (L=38 mm); 27, 30, 32 mm (L=42 mm); CrV 50BV30;
-  1/2" (12.7 mm); (50, 125 mm); CrV 50BV30;
-  1/2" (12.7 mm): 16, 21 mm; CrV 50BV30;
-  1/2" (12.7 mm); (250 mm); CrV 50BV30;
-  1/2" (12.7 mm); (250 mm); 72T; CrV 6140;
-  1/2" (12.7 mm); (317 mm); CrV 50BV30

YATO	O	
YT-12671	1/2" (12.7 mm)	5

EN Go through socket set
 PL Zestaw nasadek przelotowych z grzechotką
 DE Ratschensteckschlüsselsatz

RU Набор проходных головок с трещоткой
 CZ Sada násadových koncovek s ráčnou
 HU Dugókulcs készlet racsníval

RO Set tubulare pt. suruburi lungi
 FR Jeu de douilles traversantes avec cliquet
 IT Set di bussole con chiave a cricchetto





ES Juego de puntas de paso de trinqueta
 CN 穿心套筒组套

17 PCS
 1/2" 12.7 mm
 3/8" 9.5 mm

CrV 50BV30
 72T

QUICK RELEASE SZYBKO-ZŁĄCZE



-  10, 11, 12, 13, 14, 15, 16, 17, 18, 19, 21, 22, 24 mm; CrV 50BV30;
-  (L=195 mm); 72T; CrV 50BV30;
-  (L=76 mm); CrV 50BV30;
-  1/2" (12.7 mm); 3/8" (9.5 mm); CrV 50BV30

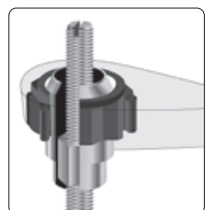

YATO	O	
YT-38653	3/8" (9.5 mm), 1/2" (12.7 mm)	10

EN Tool set
PL Zestaw narzędziowy
DE Werkzeug-Satz
RU Набор инструмента
CZ Sada nářadí
HU Szerszámkészlet

RO Trusa de scule
FR Jeu d'outils
IT Set di utensili
ES Juego de herramientas
CN 工具箱套

44
PCS

1/4"
6.3mm



CrV

S2

SK2



2



- 6x7, 8x9, 10x11, 12x13, 14x15 mm;
- 1/4" (6.3 mm): 3, 4, 5, 5.5, 6 mm (L=25 mm); AISI S2;
- 1/4" (6.3 mm): PH1, PH2, PH3 (L=25 mm); AISI S2;
- 1/4" (6.3 mm): T8, T10, T15, T20, T25, T27 (L=25 mm); AISI S2;
- 1/4" (6.3 mm): 2, 2.5, 3, 4, 5, 6 mm (L=25 mm); AISI S2;
- 160 mm;
- 160 mm;
- 200 mm;
- 300 g (L=300 mm);
- 3 m x 16 mm;
- 18 mm; SK2;
- 1/4" (6.3 mm); CrV;
- 5x75, 6x100, PH2x100 mm; S2;
- 1.5, 2, 2.5, 3, 4, 5, 6, 8, 10 mm; CrV 6150

YATO		
YT-39280	1/4" (6.3 mm)	4

EN Torx socket
PL Nasadka Torx
DE Torx-Steckschlüssel
RU Головка
CZ Nástavec Torx
HU Dugókulcs Torx
RO Cheie tubulară Torx
FR Douille Torx
IT Bullone Torx
ES Boquilla Torx
CN 星型套筒

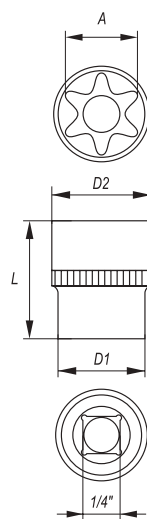

1/4"
6.3mm



CrV
50BV30



YATO	☆ A	D1 [mm]	D2 [mm]	L [mm]	PCS	
YT-05211	E4	11.9	6.7	25	24	240/480
YT-05212	E5	11.9	7.2	25	24	240/480
YT-05213	E6	11.9	8.3	25	24	240/480
YT-05214	E7	11.9	9.4	25	24	240/480
YT-05215	E8	11.9	10	25	24	240/480

EN Torx socket
PL Nasadka Torx
DE Torx-Steckschlüssel
RU Головка
CZ Nástavec Torx
HU Dugókulcs Torx
RO Cheie tubulară Torx
FR Douille Torx
IT Bullone Torx
ES Boquilla Torx
CN 星型套筒

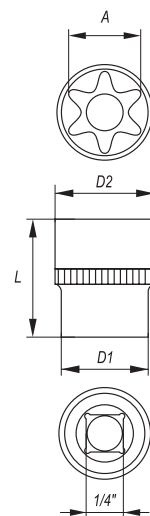

1/4"
6.3mm



DIN
2124

CrV
50BV30



YATO	☆ A	D1 [mm]	D2 [mm]	L [mm]	
YT-05244	E8	11.9	10	25	6/360

- EN Torx socket set
 PL Klucze nasadowe Torx
 DE Torx-Steckschlüsselsatz
 RU Набор головок
 CZ Nástrčné klíče
 HU Dugókulcsok Torx
- RO Trusa tubulara
 FR Clés à tube
 IT Chiavi a bussola bulloni Torx
 ES Llaves de vaso
 CN 星型套筒组套

9 PCS
1/4" 6.3mm
3/8" 9.5mm
CrV 50BV30



1/4" (6.3 mm): E5, E6, E7, E8, 3/8" (9.5 mm): E10, E12, E14, E16;
 1/4" (6.3 mm) (M) x 3/8" (9.5 mm) (F)

YATO	Ø	PCS
YT-0520	1/4" (6.3 mm)	10/40

- EN Torx socket
 PL Nasadka Torx
 DE Torx-Steckschlüssel
 RU Головка
 CZ Nástavec Torx
 HU Dugókulcs Torx
 RO Cheie tubulară Torx
 FR Douille Torx
 IT Bullone Torx
 ES Boquilla Torx
 CN 星型套筒

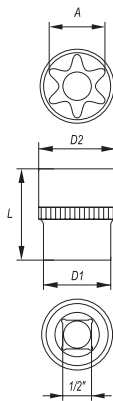

1/2" 12.7mm
DIN 2124
CrV 50BV30

YATO	Ø A	D1 [mm]	D2 [mm]	L [mm]	PCS
YT-05245	E10	21.8	13.1	38	6/180
YT-05246	E11	21.8	13.9	38	6/180
YT-05247	E12	21.8	14.9	38	6/180
YT-05248	E14	21.8	16.3	38	6/180
YT-05249	E16	21.8	18.2	38	6/180
YT-05250	E18	23.8	19.4	38	6/180
YT-05251	E20	21.8	23.9	38	6/180

- EN Hexagonal socket
 PL Nasadka sześciokątna
 DE Sechskantenschlüssel
 RU Головка шестигранная короткая
 CZ Šestihranný nástavec
 HU Dugókulcs hatszög
- RO Cheie tubulară hexagonală
 FR Douille courte
 IT Chiave a bussola esagonale
 ES Boquilla hexagonal corta
 CN 六角套筒

3/4" 19mm
DIN 3121
CrV 50BV30
AS-DRIVE

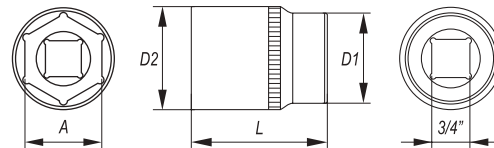

- Application: industry, car service stations and workshops
- For high loads
- Drive locks
- Surface finish: chromed, satin
- Przeznaczenie: przemysł, serwisy i warsztaty
- Do największych obciążeń
- Zamki blokujące
- Wykończenie powierzchni: chromowana, satynowa

YATO	Ø A [mm]	D1 [mm]	D2 [mm]	L [mm]	PCS
YT-1301	19	30	36	50	12
YT-1302	21	32	36	50	12
YT-1303	22	32	36	50	12
YT-1304	23	34	36	50	12
YT-1305	24	34	36	50	12
YT-1306	25	36	36	50	12
YT-1307	26	37	34	50	12
YT-1308	27	38	34	50	12
YT-1309	28	40	34	50	12
YT-1310	29	40	35	50	12
YT-1311	30	42	36	55	8
YT-1312	32	44	37	55	8
YT-1313	33	46	38	55	8

- EN Torx socket
 PL Nasadka Torx
 DE Torx-Steckschlüssel
 RU Головка
 CZ Nástavec Torx
 HU Dugókulcs Torx
 RO Cheie tubulară Torx
 FR Douille Torx
 IT Bullone Torx
 ES Boquilla Torx
 CN 星型套筒

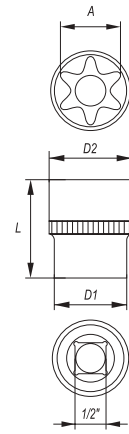

1/2" 12.7mm
CrV 50BV30

YATO	Ø A	D1 [mm]	D2 [mm]	L [mm]	PCS
YT-05220	E10	21.8	13.1	38	12
YT-05221	E11	21.8	13.9	38	12
YT-05222	E12	21.8	14.9	38	12
YT-05223	E14	21.8	16.3	38	12
YT-05224	E16	21.8	18.2	38	12
YT-05225	E18	23.8	19.4	38	12
YT-05226	E20	21.8	23.9	38	12
YT-05227	E22	23.2	25.7	38	12
YT-05228	E24	23.8	27.8	38	12

- EN Torx socket set
 PL Klucze nasadowe Torx
 DE Torx-Steckschlüsselsatz
 RU Набор головок
 CZ Nástrčné klíče
 HU Dugókulcsok Torx
- RO Trusa tubulara
 FR Clés à tube
 IT Chiavi a bussola bulloni Torx
 ES Llaves de vaso
 CN 星型套筒组套

9 PCS
1/2" 12.7mm
CrV 50BV30

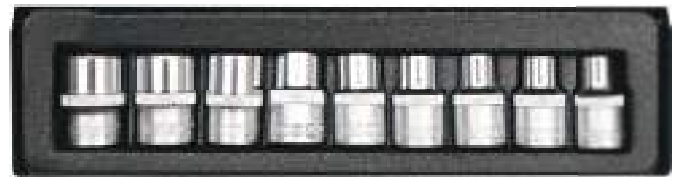

1/2" (12.7 mm): E10, E11, E12, E14, E16, E18, E20, E22, E24

YATO	Ø	PCS
YT-0521	1/2" (12.7 mm)	20

- EN Extension bar
- PL Przedłużka
- DE Verlängerung
- RU Удлинитель для воротка
- CZ Prodlužovací přípravek
- HU Toldalék
- RO Prelungitor
- FR Rallonge
- IT Prolunga
- ES Tubo de prolongación
- CN 接杆



3/4"
19mm

DIN
3121

CrV
50BV30

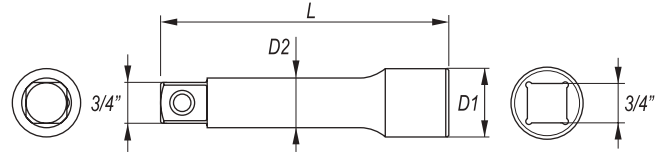

YATO	Ø	D1 [mm]	D2 [mm]	L [mm]	PCS PCBIE	
YT-1340	3/4" (19.0 mm)	36	22	100	6	36
YT-1341	3/4" (19.0 mm)	36	22	200	5	20
YT-1342	3/4" (19.0 mm)	36	22	400	5	10

- EN Adapter
- PL Redukcja
- DE Reduktion
- RU Переходник
- CZ Redukce
- HU Redukció
- RO Reducție
- FR Réduction
- IT Riduttore
- ES Reducción
- CN 转换头

3/4"
19mm

DIN
3121

CrV
50BV30

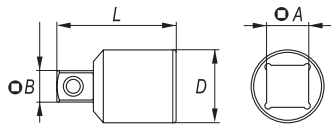

YATO	Ø A	Ø B	D [mm]	L [mm]	PCS PCBIE	
YT-1355	3/4" (19.0 mm) (F)	1/2" (12.7 mm) (M)	36	53	12	48

- EN Universal joint
- PL Przegub Cardana
- DE Kardangelenk
- RU Карданный шарнир
- CZ Kardanový kloub
- HU Kardán csukló
- RO Articulație Cardanică
- FR Cardan
- IT Snodo cardanico
- ES Articulación Cardan
- CN 万向接头

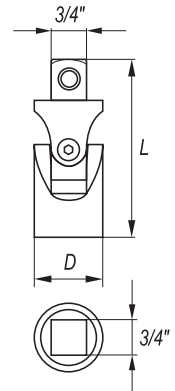

3/4"
19mm

DIN
3121

CrV
50BV30

YATO	Ø	D [mm]	L [mm]	PCS PCBIE	
YT-1352	3/4" (19.0 mm)	40	106	12	36

- EN Sliding T-bar
- PL Pokrętko typu „T”
- DE Handgriff mit Gleitstück
- RU Вороток Т-образный
- CZ Otočná račka typ „T”
- HU „T” alakú hajtókar
- RO Mâner clupă tipul „T”
- FR Barre type „T”
- IT Manopola „T” scorrevole
- ES Mango tipo „T”
- CN 滑行杆

3/4"
19mm

DIN
3121

CrV
50BV30

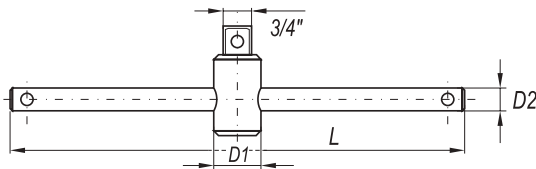

YATO	Ø	D1 [mm]	D2 [mm]	L [mm]	PCS PCBIE	
YT-1350	3/4" (19.0 mm)	37	20	500	5	10

- EN Flexible handle
- PL Pokrętko łamane
- DE Gelenkgriff
- RU Вороток шарнирный
- CZ Otočná lomená račka
- HU Hajlított hajtókar
- RO Prelungitor cu prindere flexibilă
- FR Barre pivotante
- IT Manopola a snodo
- ES Mango articulado
- CN 转向手柄

3/4"
19mm

DIN
3121

CrV
50BV30

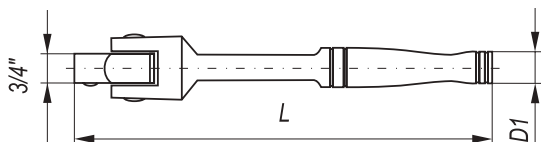

YATO	Ø	D [mm]	L [mm]	PCS PCBIE	
YT-1345	3/4" (19.0 mm)	25	507	5	10

- EN L-type handle
- PL Pokrętko typu „L”
- DE Admüternschlüssel
- RU Вороток тип „L”
- CZ Páka zahnutá
- HU „L” alakú hajtókar
- RO Măner clupă tipul „L”
- FR Barre type „L”
- IT Leva tipo „L”
- ES Mango tipo „L”
- CN L型扳手

3/4"
19mm

DIN
3121

CrV
50BV30



- EN L-type handle
- PL Pokrętko typu „L”
- DE Admüternschlüssel
- RU Вороток тип „L”
- CZ Páka zahnutá
- HU „L” alakú hajtókar
- RO Măner clupă tipul „L”
- FR Barre type „L”
- IT Leva tipo „L”
- ES Mango tipo „L”
- CN L型扳手

3/4"
19mm

DIN
3122

CrV
50BV30

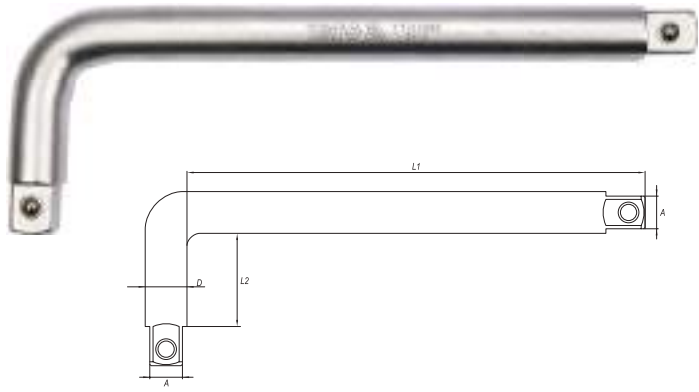
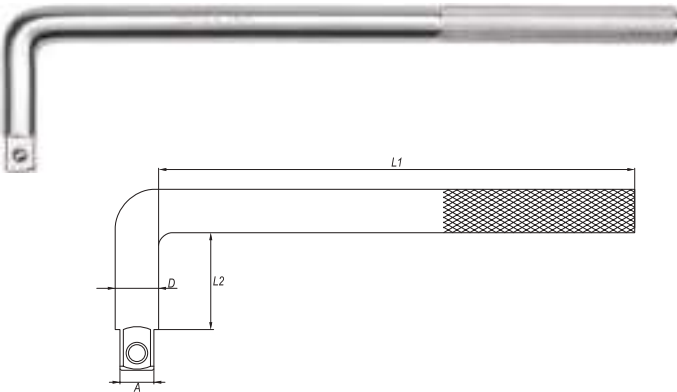
YATO	Ø	D [mm]	L1 [mm]	L2 [mm]	PCS FROM	Icon
YT-1347	3/4" (19.0 mm)	25	360	75	5	10
YT-1348	3/4" (19.0 mm)	25	410	75	5	10

YATO	Ø	D [mm]	L1 [mm]	L2 [mm]	Icon
YT-13465	3/4" (19.0 mm)	25	275	75	2/12
YT-13475	3/4" (19.0 mm)	25	373	75	2/8
YT-13490	3/4" (19.0 mm)	25	578	75	2/8

- EN Quick release ratchet handle
- PL Grzechotka
- DE Hebelumschaltknarre
- RU Трещотка
- CZ Ráčna
- HU Racsnis hajtókar
- RO Dispozitiv de prindere cu clichet
- FR Clé à cliquet
- IT Cricchetto bussola
- ES Carraca
- CN 快速脱落棘轮扳手



3/4"
19mm

DIN
3112

24T

CrV
6140



YATO	Ø	T	L [mm]	Icon
YT-1360	3/4" (19.0 mm)	24	615	10

- EN Tool set
- PL Zestaw narzędziowy
- DE Werkzeug-Satz
- RU Набор инструмента
- CZ Sada nářadí
- HU Szerszámkészlet
- RO Trusa de scule
- FR Jeu d'outils
- IT Set di utensili
- ES Juego de herramientas
- CN 工具组套



15
PCS

3/4"
19mm

CrV
50BV30

CrV
6140

QUICK RELEASE SZYBKO-ZŁĄCZE

24T

AS-DRIVE



- 3/4" (19.0 mm): 30, 32, 34 (L=55 mm); 36, 38 (L=60 mm); 41 (L=65 mm); 46, 50 (L=70 mm); 55 (L=75 mm); 60 mm (L=80 mm); CrV 50BV30;
- 3/4" (19.0 mm); (L=100, 200 mm); CrV 50BV30;
- 3/4" (19.0 mm); (L=106 mm); CrV 50BV30;
- 3/4" (19.0 mm); (L=500 mm); CrV 50BV30;
- 3/4" (19.0 mm); (L=500 mm); 24T; CrV 6140

YATO	Ø	Icon
YT-1334	3/4" (19.0 mm)	1

- EN Tool set
- PL Zestaw narzędziowy
- DE Werkzeug-Satz
- RU Набор инструмента
- CZ Sada nářadí
- HU Szerszámkészlet
- RO Trusa de scule
- FR Jeu d'outils
- IT Set di utensili
- ES Juego de herramientas
- CN 工具组套



20
PCS

3/4"
19mm

CrV
50BV30

CrV
6140

QUICK RELEASE SZYBKO-ZŁĄCZE

24T

AS-DRIVE



- 3/4" (19.0 mm): 19, 21, 22, 24 mm (L=50 mm); 26, 27, 28 mm (L=52 mm); 30, 32 mm (L=53 mm); 33, 34 mm (L=56 mm); 36 mm (L=58 mm); 38 mm (L=60 mm); 41 mm (L=64 mm); 46 mm (L=68 mm); 50 mm (L=72mm); CrV 50BV30;
- 3/4" (19.0 mm); (L=100, 200 mm); CrV 50BV30;
- 3/4" (19.0 mm); (L=500 mm); CrV 50BV30;
- 3/4" (19.0 mm); (L=620 mm); CrV 6140

YATO	Ø	Icon
YT-1335	3/4" (19.0 mm)	1

EN Bit socket
PL Klucz trzpieniowy
DE Bit-Stecknuss
RU Головка торцевая с вставкой
CZ Hlavice s bitem
HU Csapkulcs
RO Chei cu cozi
FR Douille tournevis
IT Chiavi a bussola a giravite
ES Llave de mandril
CN 星型旋具套筒

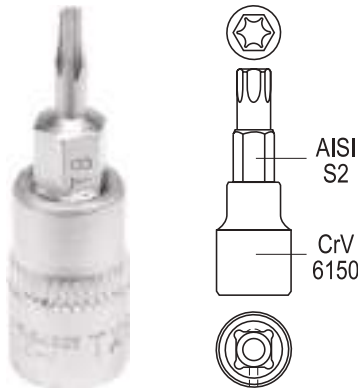

EN Bit socket
PL Klucz trzpieniowy
DE Bit-Stecknuss
RU Головка торцевая с вставкой
CZ Hlavice s bitem
HU Csapkulcs
RO Chei cu cozi
FR Douille tournevis
IT Chiavi a bussola a giravite
ES Llave de mandril
CN 六角旋具套筒

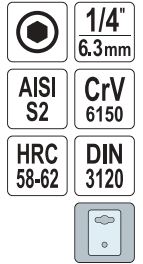

YATO	Ø	⊕	L [mm]	[Nm]	📦
YT-04301	1/4" (6.3 mm)	T8	37	2.6	150/600
YT-04302	1/4" (6.3 mm)	T10	37	4.6	150/600
YT-04303	1/4" (6.3 mm)	T15	37	7.7	150/600
YT-04304	1/4" (6.3 mm)	T20	37	12.7	150/600
YT-04305	1/4" (6.3 mm)	T25	37	19.0	150/600
YT-04306	1/4" (6.3 mm)	T30	37	37.4	150/600
YT-04307	1/4" (6.3 mm)	T40	37	65.0	150/600

YATO	Ø	⊙ [mm]	L [mm]	[Nm]	📦
YT-04370	1/4" (6.3 mm)	3	37	6.6	150/600
YT-04371	1/4" (6.3 mm)	4	37	16.0	150/600
YT-04372	1/4" (6.3 mm)	5	37	30.0	150/600
YT-04373	1/4" (6.3 mm)	6	37	52.2	150/600
YT-04374	1/4" (6.3 mm)	7	37	78.0	150/600
YT-04375	1/4" (6.3 mm)	8	37	120.0	150/600

EN Bit socket
PL Klucz trzpieniowy
DE Bit-Stecknuss
RU Головка торцевая с вставкой
CZ Hlavice s bitem
HU Csapkulcs
RO Chei cu cozi
FR Douille tournevis
IT Chiavi a bussola a giravite
ES Llave de mandril
CN 十字旋具套筒

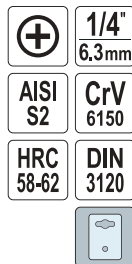

EN Bit socket
PL Klucz trzpieniowy
DE Bit-Stecknuss
RU Головка торцевая с вставкой
CZ Hlavice s bitem
HU Csapkulcs
RO Chei cu cozi
FR Douille tournevis
IT Chiavi a bussola a giravite
ES Llave de mandril
CN 十字旋具套筒



YATO	Ø	⊕	L [mm]	[Nm]	📦
YT-04411	1/4" (6.3 mm)	PH1	37	3.5	150/600
YT-04412	1/4" (6.3 mm)	PH2	37	8.2	150/600
YT-04413	1/4" (6.3 mm)	PH3	37	19.5	150/600

YATO	Ø	⊕	L [mm]	[Nm]	📦
YT-04417	1/4" (6.3 mm)	PZ1	37	3.5	150/600
YT-04418	1/4" (6.3 mm)	PZ2	37	8.2	150/600

EN Bit socket
 PL Klucz trzpieniowy
 DE Bit-Stecknuss
 RU Головка торцевая с вставкой
 CZ Hlavice s bitem
 HU Csapkulcs
 RO Chei cu cozi
 FR Douille tournevis
 IT Chiavi a bussola a giravite
 ES Llave de mandril
 CN 六角旋具套筒

1/2" 12.7mm

AISI S2 **CrV 6150**

HRC 58-62 **DIN 3120**



YATO	Ø	◎ [mm]	L [mm]	[Nm]	
YT-04381	1/2" (12.7 mm)	5	55	30	40/240
YT-04382	1/2" (12.7 mm)	6	55	52	40/240
YT-04383	1/2" (12.7 mm)	7	55	78	40/240
YT-04384	1/2" (12.7 mm)	8	55	120	40/240
YT-04385	1/2" (12.7 mm)	10	55	220	40/160
YT-04386	1/2" (12.7 mm)	12	55	370	40/160
YT-04387	1/2" (12.7 mm)	14	55	590	40/160
YT-04388	1/2" (12.7 mm)	17	55	1000	40/160

EN Bit socket
 PL Klucz trzpieniowy
 DE Bit-Stecknuss
 RU Головка торцевая с вставкой
 CZ Hlavice s bitem
 HU Csapkulcs
 RO Chei cu cozi
 FR Douille tournevis
 IT Chiavi a bussola a giravite
 ES Llave de mandril
 CN 星型旋具套筒

1/2" 12.7mm

AISI S2 **CrV 6150**

HRC 58-62 **DIN 3120**



YATO	Ø	◎	L [mm]	[Nm]	
YT-04310	1/2" (12.7 mm)	T20	55	12.7	40/240
YT-04311	1/2" (12.7 mm)	T25	55	19.0	40/240
YT-04312	1/2" (12.7 mm)	T27	55	27.0	40/240
YT-04313	1/2" (12.7 mm)	T30	55	37.4	40/240
YT-04314	1/2" (12.7 mm)	T40	55	65.0	40/240
YT-04315	1/2" (12.7 mm)	T45	55	103.5	40/240
YT-04316	1/2" (12.7 mm)	T50	55	159.0	40/240
YT-04317	1/2" (12.7 mm)	T55	55	257.0	40/240
YT-04318	1/2" (12.7 mm)	T60	55	445.0	40/160
YT-04319	1/2" (12.7 mm)	T70	55	700.0	40/160

EN Bit socket
 PL Klucz trzpieniowy
 DE Bit-Stecknuss
 RU Головка торцевая с вставкой
 CZ Hlavice s bitem
 HU Csapkulcs
 RO Chei cu cozi
 FR Douille tournevis
 IT Chiavi a bussola a giravite
 ES Llave de mandril
 CN 十二角旋具套筒

1/2" 12.7mm

AISI S2 **CrV 6150**

HRC 58-62 **DIN 3120**



YATO	Ø	◎	L [mm]	[Nm]	
YT-04341	1/2" (12.7 mm)	M6	55	30	40/240
YT-04342	1/2" (12.7 mm)	M8	55	52	40/240
YT-04343	1/2" (12.7 mm)	M10	55	120	40/160
YT-04344	1/2" (12.7 mm)	M12	55	220	40/160
YT-04345	1/2" (12.7 mm)	M14	55	370	40/160
YT-04346	1/2" (12.7 mm)	M16	55	590	40/160

EN Bit socket
 PL Klucz trzpieniowy
 DE Bit-Stecknuss
 RU Головка торцевая с вставкой
 CZ Hlavice s bitem
 HU Csapkulcs
 RO Chei cu cozi
 FR Douille tournevis
 IT Chiavi a bussola a giravite
 ES Llave de mandril
 CN 六角旋具套筒

1/2" 12.7mm

AISI S2 **CrV 6150**

HRC 58-62 **DIN 3120**

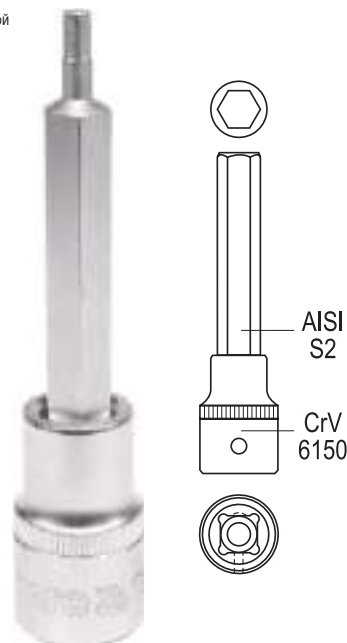

YATO	Ø	◎ [mm]	L [mm]	[Nm]	
YT-04390	1/2" (12.7 mm)	4	100	16	20/120
YT-04391	1/2" (12.7 mm)	5	100	30	20/120
YT-04392	1/2" (12.7 mm)	6	100	52	20/120
YT-04393	1/2" (12.7 mm)	7	100	78	20/120
YT-04394	1/2" (12.7 mm)	8	100	120	20/120
YT-04395	1/2" (12.7 mm)	10	100	220	20/120
YT-04396	1/2" (12.7 mm)	12	100	370	20/120
YT-04397	1/2" (12.7 mm)	14	100	590	20/120
YT-04398	1/2" (12.7 mm)	17	100	1000	20/120

EN Bit socket
PL Klucz trzpieniowy
DE Bit-Stecknuss
RU Головка торцевая с вставкой
CZ Hlavice s bitem
HU Csapkulcs
RO Chei cu cozi
FR Douille tournevis
IT Chiavi a bussola a giravite
ES Llave de mandril
CN 星型旋具套筒

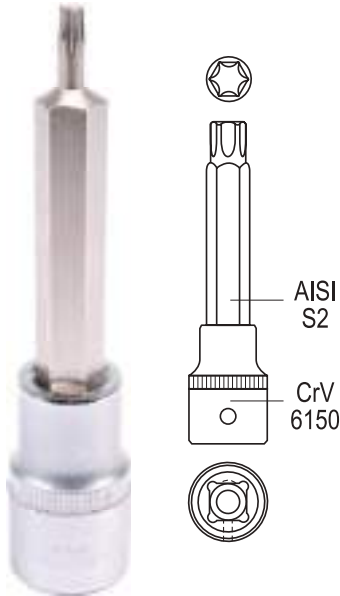

1/2"
12.7mm
AISI S2
CrV 6150
HRC 58-62
DIN 3120

EN Bit socket
PL Klucz trzpieniowy
DE Bit-Stecknuss
RU Головка торцевая с вставкой
CZ Hlavice s bitem
HU Csapkulcs
RO Chei cu cozi
FR Douille tournevis
IT Chiavi a bussola a giravite
ES Llave de mandril
CN 十二角旋具套筒

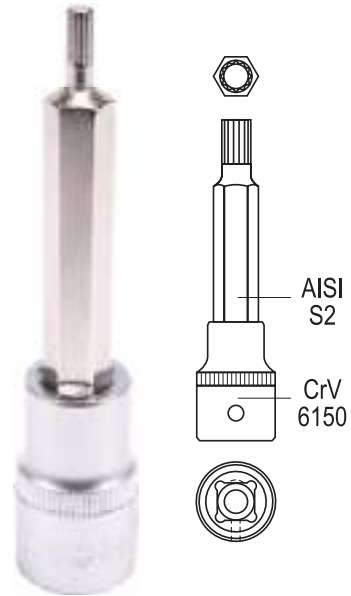

1/2"
12.7mm
AISI S2
CrV 6150
HRC 58-62
DIN 3120

YATO	Ø	⊙	L [mm]	[Nm]	☐
YT-04320	1/2" (12.7 mm)	T20	100	12.7	20/120
YT-04321	1/2" (12.7 mm)	T25	100	19.0	20/120
YT-04322	1/2" (12.7 mm)	T27	100	27.0	20/120
YT-04323	1/2" (12.7 mm)	T30	100	37.4	20/120
YT-04324	1/2" (12.7 mm)	T40	100	65.0	20/120
YT-04325	1/2" (12.7 mm)	T45	100	103.5	20/120
YT-04326	1/2" (12.7 mm)	T50	100	159.0	20/120
YT-04327	1/2" (12.7 mm)	T55	100	257.0	20/120
YT-04328	1/2" (12.7 mm)	T60	100	445.0	20/120
YT-04329	1/2" (12.7 mm)	T70	100	700.0	20/120

YATO	Ø	⊙	L [mm]	[Nm]	☐
YT-04350	1/2" (12.7 mm)	M5	100	16	20/120
YT-04351	1/2" (12.7 mm)	M6	100	30	20/120
YT-04352	1/2" (12.7 mm)	M8	100	52	20/120
YT-04353	1/2" (12.7 mm)	M10	100	120	20/120
YT-04354	1/2" (12.7 mm)	M12	100	220	20/120
YT-04355	1/2" (12.7 mm)	M14	100	370	20/120
YT-04356	1/2" (12.7 mm)	M16	100	590	20/120
YT-04357	1/2" (12.7 mm)	M17	100	590	20/120

EN Key wrench ratchet handle
PL Grzechotka Hex
DE Ratsche Hex
RU Трещотка Hex
CZ Ráčna Hex
HU Racsnis Hex
RO Antrenor cu clichet cu bit
FR Clé à cliquet Hex
IT Cricchetto Hex
ES Carraca Hex
CN 双向棘轮内六角扳手

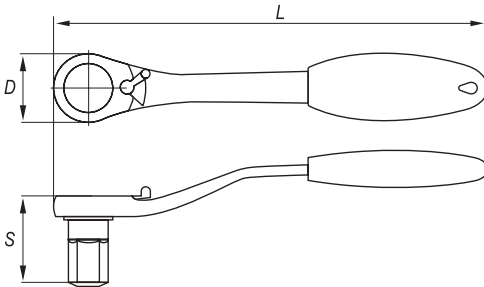

72T
HRC 42-48
CrV 50BV30

YATO	Ø [mm]	L [mm]	D [mm]	S [mm]	☐
YT-02390	4	135	18	29	8/160
YT-02391	5	135	18	29	8/160
YT-02392	6	145	23	32	6/120
YT-02393	8	145	23	32	6/120
YT-02394	10	190	31	35	6/60
YT-02395	12	190	31	35	6/60
YT-02396	14	225	36	36	5/40
YT-02397	17	225	36	36	5/40

EN Universal socket wrench
PL Klucz z uniwersalną nasadką
DE Universal-Steckschlüssel
RU Универсальная торцевая головка с трещоткой
CZ Univerzální klíč
HU Univerzális csavarkulcs
RO Antrenor cu clichet cu tubulara universala
FR Clé à douille universelle
IT Chiave con presa universale
ES Llave de tubo universal
CN 双向棘轮万能扳手

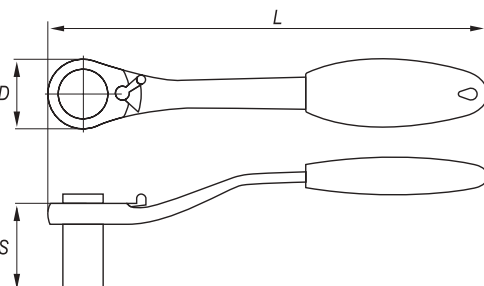

72T
HRC 40
CrV 50BV30



YATO	Ø [mm]	L [mm]	D [mm]	S [mm]	☐
YT-02400	8-19	225	36	54	5/40

EN Bit sockets
 PL Klucze trzpieniowe
 DE Bit-Stecknuss-Set
 RU Набор головок со вставкой
 CZ Sada nástrčných hlavíc s bitem
 HU Dugókulcs készlet
 RO Chei cu cozi
 FR Douille tournevis
 IT Serie di chiavi a bussola a giravite
 ES Juego de llaves de mandril
 CN 中孔星型旋具套筒组套

12 PCS		1/4" 6.3mm	3/8" 9.5mm	AISI S2
CrV 6150	HRC 58-62	DIN 3120		



EN Bit sockets
 PL Klucze trzpieniowe
 DE Bit-Stecknuss-Set
 RU Набор головок со вставкой
 CZ Sada nástrčných hlavíc s bitem
 HU Dugókulcs készlet
 RO Chei cu cozi
 FR Douille tournevis
 IT Serie di chiavi a bussola a giravite
 ES Juego de llaves de mandril
 CN 中孔星型旋具套筒组套

12 PCS		1/4" 6.3mm	3/8" 9.5mm	AISI S2
CrV 6150	HRC 58-62	DIN 3120		



1/4" (6.3 mm): T8, T10, T15, T20, T25, T27, T30 (L=37 mm);
 3/8" (9.5 mm): T40, T45, T47, T50, T55 (L=48 mm)

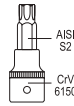

1/4" (6.3 mm): T8, T10, T15, T20, T25, T27, T30 (L=37 mm);
 3/8" (9.5 mm): T40, T45, T47, T50, T55 (L=48 mm)

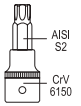

YATO

YT-04331 10/40

YATO

YT-04332 10/40

EN Bit sockets
 PL Klucze trzpieniowe
 DE Bit-Stecknuss-Set
 RU Набор головок со вставкой
 CZ Sada nástrčných hlavíc s bitem
 HU Dugókulcs készlet
 RO Chei cu cozi
 FR Douille tournevis
 IT Serie di chiavi a bussola a giravite
 ES Juego de llaves de mandril
 CN 中孔星型旋具套筒组套

9 PCS		1/4" 6.3mm	3/8" 9.5mm	AISI S2
CrV 6150	HRC 58-62	DIN 3120		



EN Bit sockets
 PL Klucze trzpieniowe
 DE Bit-Stecknuss-Set
 RU Набор головок со вставкой
 CZ Sada nástrčných hlavíc s bitem
 HU Dugókulcs készlet
 RO Chei cu cozi
 FR Douille tournevis
 IT Serie di chiavi a bussola a giravite
 ES Juego de llaves de mandril
 CN 中孔星型旋具套筒组套

5 PCS		1/4" 6.3mm	3/8" 9.5mm	AISI S2
CrV 6150	HRC 58-62	DIN 3120		



1/4" (6.3 mm): 2, 3, 4, 5, 6 mm (L=37 mm);
 3/8" (9.5 mm): 7, 8, 10, 12 mm (L=48 mm)

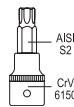

1/4" (6.3 mm): M5, M6 (L=37 mm);
 3/8" (9.5 mm): M8, M10, M12 (L=48 mm)

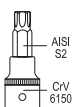

YATO

YT-04401 6/36

YATO

YT-04360 12/48

EN Bit sockets
 PL Klucze trzpieniowe
 DE Bit-Stecknuss-Set
 RU Набор головок со вставкой
 CZ Sada nástrčných hlavíc s bitem
 HU Dugókulcs készlet
 RO Chei cu cozi
 FR Douille tournevis
 IT Serie di chiavi a bussola a giravite
 ES Juego de llaves de mandril
 CN 中孔星型旋具套筒组套

7 PCS		1/4" 6.3mm	AISI S2	CrV 6150	DIN 3120	HRC 58-62	
----------	--	---------------	------------	-------------	-------------	--------------	--



1/4" (6.3 mm): T10, T15, T20, T25, T27, T30, T40 (L=35 mm)

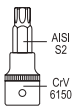

YATO

YT-0461 12/48

EN Bit socket set
PL Zestaw kluczy trzpieniowych
DE Aufsteckschlüssel-Satz
RU Набор ронбок-вставок
CZ Čepové klíče
HU Csapkulcs
RO Chei cu cozi
FR Set de douilles tournevis
IT Chiavi a bussola a vite
ES Juego de llaves de mandril
CN 星型套筒批头组套



18
PCS

1/2"
12.7mm

1/4"
6.3mm

AISI
S2

CrV
6150

DIN
3120

HRC
58-62

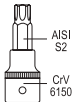

1/2" (12.7 mm): T30, T40, T45, T50, T55, T60 (L=50 mm); T30, T40, T45, T50, T55, T60 (L=100 mm);
1/4" (6.3 mm): T10, T15, T20, T25, T30, T40 (L=37 mm); AISI S2 / CrV 6150

YATO	○	
YT-7751	1/4" (6.3 mm), 1/2" (12.7 mm)	10

EN Bit socket set
PL Zestaw kluczy trzpieniowych
DE Aufsteckschlüssel-Satz
RU Набор ронбок-вставок
CZ Čepové klíče
HU Csapkulcs
RO Chei cu cozi
FR Set de douilles tournevis
IT Chiavi a bussola a vite
ES Juego de llaves de mandril
CN 批头组套



32
PCS

1/2"
12.7mm

S2

CrV

1/2" (12.7 mm): T20, T25, T27, T30, T40, T45, T50, T55, T60, T70 (L=55 mm);
1/2" (12.7 mm): T20, T25, T27, T30, T40, T45, T50, T55, T60, T70 (L=100 mm);
1/2" (12.7 mm): T40, T45, T50, T55, T60, T70 (L=140 mm);
1/2" (12.7 mm): T40, T45, T50, T55, T60, T70 (L=200 mm); S2 / CrV

YATO	○	
YT-77541	1/2" (12.7 mm)	3

EN Bit socket set
PL Zestaw kluczy trzpieniowych
DE Aufsteckschlüssel-Satz
RU Набор ронбок-вставок
CZ Čepové klíče
HU Csapkulcs
RO Chei cu cozi
FR Set de douilles tournevis
IT Chiavi a bussola a vite
ES Juego de llaves de mandril
CN 六角套筒批头组套



18
PCS

1/2"
12.7mm

1/4"
6.3mm

AISI
S2

CrV
6150

DIN
3120

HRC
58-62

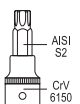

1/2" (12.7 mm): 5, 6, 7, 8, 10, 12 mm (L=50 mm); 5, 6, 7, 8, 10, 12 mm (L=100 mm);
1/4" (6.3 mm): 3, 4, 5, 6, 7, 8 mm (L=37 mm); AISI S2 / CrV 6150

YATO	○	
YT-7752	1/4" (6.3 mm), 1/2" (12.7 mm)	10

- EN Bit socket set
- PL Zestaw kluczy trzpieniowych
- DE Aufsteckschlüssel-Satz
- RU Набор роненок-вставок
- CZ Čepové klíče
- HU Csapkulcs
- RO Chei cu cozi
- FR Set de douilles tournevis
- IT Chiavi a bussola a vite
- ES Juego de llaves de mandril
- CN 批头组套



30 PCS		1/2" 12.7mm
S2	CrV	

□ 1/2" (12.7 mm): 5, 6, 7, 8, 10, 12, 14, 17, 19 mm (L=55 mm);
 1/2" (12.7 mm): 5, 6, 7, 8, 10, 11, 12, 13 mm (L=100 mm);
 1/2" (12.7 mm): 5, 6, 7, 8, 10, 12, 14 mm (L=140 mm);
 1/2" (12.7 mm): 5, 6, 7, 8, 10, 12 mm (L=200 mm); S2 / CrV

YATO		
YT-77540	1/2" (12.7 mm)	3

- EN Bit socket set
- PL Zestaw kluczy trzpieniowych
- DE Aufsteckschlüssel-Satz
- RU Набор роненок-вставок
- CZ Čepové klíče
- HU Csapkulcs
- RO Chei cu cozi
- FR Set de douilles tournevis
- IT Chiavi a bussola a vite
- ES Juego de llaves de mandril
- CN 花型套筒批头组套



12 PCS		1/2" 12.7mm
AISI S2	CrV 6150	DIN 3120
HRC 58-62		

□ 1/2" (12.7 mm): M12, M17 (L=50 mm); M6 (L=70 mm); M7, M8 (L=100 mm); M8, M10 (L=120 mm);
 M6, M10, M12 (L=140 mm); M5 (L=180 mm); M6 (L=250 mm); AISI S2 / CrV 6150

YATO		
YT-7753	1/2" (12.7 mm)	10



- EN Bit socket set
- PL Zestaw kluczy trzpieniowych
- DE Aufsteckschlüssel-Satz
- RU Набор роненок-вставок
- CZ Čepové klíče
- HU Csapkulcs
- RO Chei cu cozi
- FR Set de douilles tournevis
- IT Chiavi a bussola a vite
- ES Juego de llaves de mandril
- CN 批头组套



26 PCS		1/2" 12.7mm
S2	CrV	

□ 1/2" (12.7 mm): M5, M6, M8, M9, M10, M12, M14, M16 (L=55 mm);
 1/2" (12.7 mm): M5, M6, M8, M9, M10, M12, M14 (L=100 mm);
 1/2" (12.7 mm): M5, M6, M8, M9, M10, M12, M14 (L=140 mm);
 1/2" (12.7 mm): M8, M10, M12, M14 (L=200 mm); S2 / CrV

YATO		
YT-77542	1/2" (12.7 mm)	3



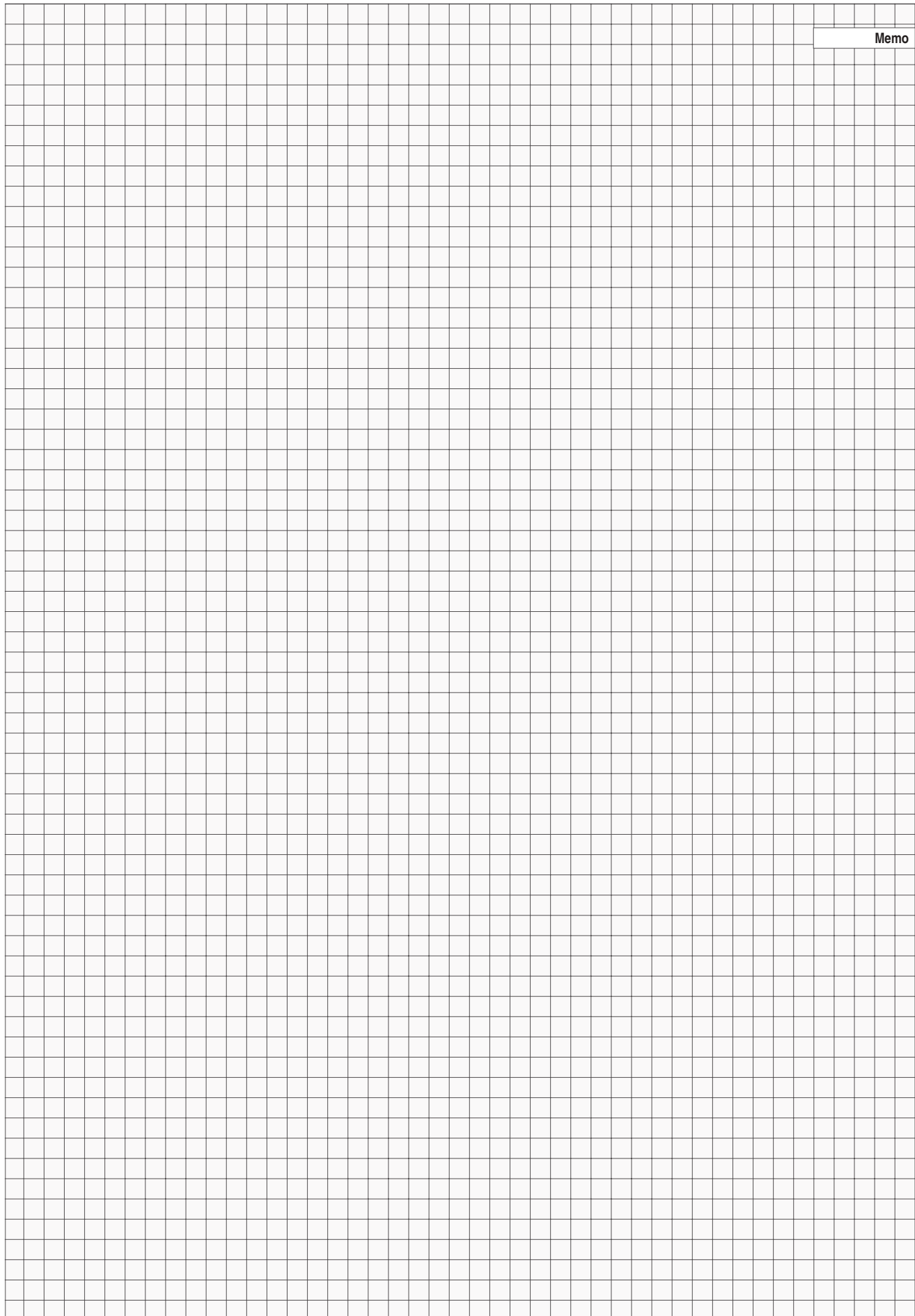







Memo



3

**Impact sockets,
accessories & sets**
**Udarowe klucze nasadowe,
akcesoria i zestawy**



<p>Impact accessories 1/4" Akcesoria udarowe 1/4"</p> <p style="text-align: right;">62 </p>	<p>Impact accessories 3/4" Akcesoria udarowe 3/4"</p> <p style="text-align: right;">65 </p>
<p>Impact universal joints Przeguby kuliste udarowe</p> <p style="text-align: right;">62</p>	<p>Impact extension bars Przedłużki udarowe</p> <p style="text-align: right;">65</p> <p>Impact adapters Redukcje udarowe</p> <p style="text-align: right;">65</p> <p>Impact universal joints Przeguby kuliste udarowe</p> <p style="text-align: right;">65</p>
<p>Impact accessories 3/8" Akcesoria udarowe 3/8"</p> <p style="text-align: right;">62 </p>	<p>Impact sockets 1" Udarowe klucze nasadowe 1"</p> <p style="text-align: right;">66 </p>
<p>Impact universal joints Przeguby kuliste udarowe</p> <p style="text-align: right;">62</p>	<p>Impact sockets Klucze nasadowe udarowe, krótkie</p> <p style="text-align: right;">66</p> <p>Deep impact sockets Klucze nasadowe udarowe, długie</p> <p style="text-align: right;">66</p>
<p>Impact sockets 1/2" Klucze nasadowe udarowe 1/2"</p> <p style="text-align: right;">62-63 </p>	<p>Impact accessories 1" Akcesoria udarowe 1"</p> <p style="text-align: right;">66 </p>
<p>Impact sockets & sets Klucze nasadowe udarowe i zestawy, krótkie</p> <p style="text-align: right;">62</p> <p>Deep impact sockets & sets Klucze nasadowe udarowe i zestawy, długie</p> <p style="text-align: right;">63</p>	<p>Impact extension bars with adapter Przedłużki udarowe z redukcją</p> <p style="text-align: right;">66</p> <p>Impact universal joints Przeguby kuliste udarowe</p> <p style="text-align: right;">66</p>
<p>Impact accessories 1/2" Akcesoria udarowe 1/2"</p> <p style="text-align: right;">63-64 </p>	<p>Impact accessories sets Zestawy akcesoriów udarowych</p> <p style="text-align: right;">66-67 </p>
<p>Impact extension bars Przedłużki udarowe</p> <p style="text-align: right;">63</p> <p>Impact adapters Redukcje udarowe</p> <p style="text-align: right;">63</p> <p>Impact universal joints Przeguby kuliste udarowe</p> <p style="text-align: right;">64</p>	<p>Impact sockets for front hub nuts Nasadki udarowe do piast</p> <p style="text-align: right;">67 </p>
<p>Impact sockets 3/4" Udarowe klucze nasadowe 3/4"</p> <p style="text-align: right;">64-65 </p>	<p>Impact bit sets & accessories Zestawy bitów udarowych i akcesoria</p> <p style="text-align: right;">67-69 </p>
<p>Impact sockets & sets Klucze nasadowe udarowe i zestawy, krótkie</p> <p style="text-align: right;">64</p> <p>Deep impact sockets & sets Klucze nasadowe udarowe i zestawy, długie</p> <p style="text-align: right;">64</p>	

- EN Impact universal joint
- PL Przegub kulisty uderowy
- DE Kraft-Kugelgelenk
- RU Ударный шаровой шарнир
- CZ Kulový rázový kloub
- HU Csuklós csatlakozó gépi
- RO Articulație universală de impact
- FR Joint universel à impact
- IT Giunto universale a impatto
- ES Junta de impacto universal
- CN 重型气动万向接头

1/4"
6.3mm

CrMo
SCM440

FOR IMPACT TOOLS
DO NARZĘDZI UDAROWYCH



- EN Impact universal joint
- PL Przegub kulisty uderowy
- DE Kraft-Kugelgelenk
- RU Ударный шаровой шарнир
- CZ Kulový rázový kloub
- HU Csuklós csatlakozó gépi
- RO Articulație universală de impact
- FR Joint universel à impact
- IT Giunto universale a impatto
- ES Junta de impacto universal
- CN 重型气动万向接头

3/8"
9.5mm

CrMo
SCM440

FOR IMPACT TOOLS
DO NARZĘDZI UDAROWYCH



YATO	Ø	D1 [mm]	D2 [mm]	L [mm]	PCS
YT-10630	1/4" (6.3 mm)	17	8.3	34.5	20/200

YATO	Ø	D1 [mm]	D2 [mm]	L [mm]	PCS
YT-10632	3/8" (9.5 mm)	24.6	12.8	48	20/100

- EN Hexagonal impact socket
- PL Nasadka uderowa sześciokątna
- DE Kraftschrauber-Einsatz
- RU Головка ударная 6-гранная
- CZ Šestihranný nástavec
- HU Gépi dugókulcs hatszög
- RO Cheie tubulară hexagonală de impact
- FR Douille à choc
- IT Chiave a bussola esagonale per percussione
- ES Boquilla de percusión
- CN 风动套筒

1/2"
12.7mm

CrMo
SCM440

AS-DRIVE

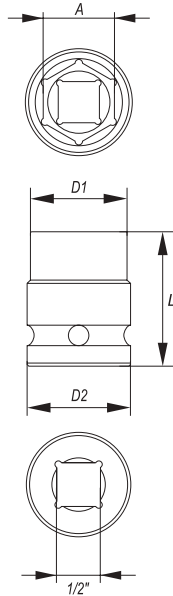
YATO	Ø A [mm]	D1 [mm]	D2 [mm]	L [mm]	PCS
YT-1000	10	17.5	25	39	60
YT-1001	11	18.5	25	39	60
YT-1002	12	20.0	25	39	60
YT-1003	13	21.0	25	39	60
YT-1004	14	22.5	25	39	60
YT-1005	15	23.5	30	39	40
YT-1006	16	24.0	30	39	40
YT-1007	17	26.0	30	39	40
YT-1008	18	27.5	30	39	40
YT-1009	19	28.0	30	39	40
YT-1010	20	30.0	30	39	40
YT-1011	21	30.0	30	39	40
YT-1012	22	32.0	30	39	30
YT-1013	23	32.0	30	39	30
YT-1014	24	34.0	30	43	30
YT-1015	25	35.0	30	43	30
YT-1016	26	38.0	30	43	24
YT-1017	27	38.0	30	43	24
YT-1018	28	40.0	30	48	24
YT-1019	29	41.0	30	48	22
YT-1020	30	42.0	30	48	24
YT-1022	32	44.0	30	48	20

- EN Impact socket set
- PL Zestaw nasadek uderowych
- DE Kraftschrauber-Einsätze
- RU Набор торцевых ударных головок
- CZ Sada úderových nástrčných hlavíc
- HU Gépi dugókulcs készlet
- RO Set chei tubulare pt. impact
- FR Jeu de douilles à choc
- IT Set di chiavi a bussola a percussione
- ES Juego de vasos de impacto
- CN 风动套筒组套

10
PCS

1/2"
12.7mm

CrMo
SCM440

AS-DRIVE





YATO	Ø	PCS
YT-1025	1/2" (12.7 mm)	20

1/2" (12.7 mm): 10, 12, 13, 14, 15, 16, 17, 18, 19, 22 mm (L=39 mm)

EN Hexagonal deep impact socket
PL Nasadka udarowa sześciokątna długa
DE Kraftschrauber-Einsatz, lang
RU Головка ударная 6-гранная глубокая
CZ Šestihřanný hluboký nástavec
HU Gépi dugókulcs hatszög hosszú

RO Cheie tubulară hexagonală de impact adâncă
FR Douille profonde à choc
IT Chiave a bussola esagonale per percussione
ES Boquilla de percusión profunda
CN 风动套筒

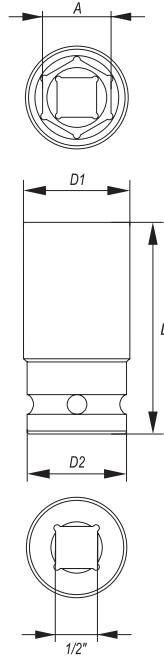
1/2" 12.7mm CrMo SCM440 AS-DRIVE



YATO	o A [mm]	D1 [mm]	D2 [mm]	L [mm]	PCS PCS/BOX	
YT-1030	10	17.5	24	78	30	120
YT-1031	11	18.5	24	78	30	120
YT-1032	12	20.0	24	78	30	120
YT-1033	13	21.0	24	78	30	120
YT-1034	14	22.0	24	78	30	120
YT-1035	15	23.7	24	78	30	120
YT-1036	16	24.0	24	78	30	120
YT-1037	17	26.0	26	78	25	100
YT-1038	18	28.0	28	78	24	96
YT-1039	19	28.0	28	78	24	96
YT-1040	20	30.0	30	78	20	80
YT-1041	21	30.0	30	78	20	80
YT-1042	22	32.0	30	78	18	72
YT-1043	23	32.0	30	78	15	60
YT-1044	24	34.0	30	78	15	60
YT-1045	25	35.0	30	78	15	60
YT-1046	26	38.0	30	78	12	48
YT-1047	27	38.0	30	78	12	48
YT-1048	28	40.0	30	78	12	48
YT-1049	29	41.0	30	78	10	40
YT-1050	30	42.0	30	78	10	40
YT-1052	32	44.0	30	78	10	40

EN Impact socket set
PL Zestaw nasadek udarowych
DE Kraftschrauber-Einsätze
RU Набор торцевых ударных головок
CZ Sada úderových nástrčných hlavic
HU Gépi dugókulcs készlet
RO Set chei tubulare pt. impact
FR Jeu de douilles à choc
IT Set di chiavi a bussola a percussione
ES Juego de vasos de impacto
CN 风动套筒组套



11 PCS 1/2" 12.7mm CrMo SCM440 AS-DRIVE

1/2" (12.7 mm): 10, 12, 13, 14, 15, 16, 17, 18, 19, 22, 24 mm (L=78 mm)

YATO	o	
YT-1054	1/2" (12.7 mm)	10

EN Impact socket set
PL Zestaw nasadek udarowych
DE Kraftschrauber-Einsätze
RU Набор торцевых ударных головок
CZ Sada úderových nástrčných hlavic
HU Gépi dugókulcs készlet
RO Set chei tubulare pt. impact
FR Jeu de douilles à choc
IT Set di chiavi a bussola a percussione
ES Juego de vasos de impacto
CN 风动套筒组套



15 PCS 1/2" 12.7mm CrMo SCM440 AS-DRIVE

1/2" (12.7 mm): 10, 12, 13, 14, 15, 16, 17, 18, 19, 21, 22, 24, 27, 30, 32 mm (L=78 mm)

YATO	o	
YT-1055	1/2" (12.7 mm)	4

EN Impact extension bar
PL Przedłużka udarowa
DE Verlängerung
RU Удлинитель ударный
CZ Prodlužovací přípravek
HU Toldalék
RO Prelungitor
FR Rallonge
IT Prolunga per percussione
ES Tubo de prolongación
CN 风动接杆

1/2" 12.7mm CrMo SCM440

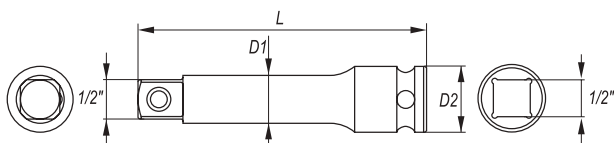

YATO	o	D1 [mm]	D2 [mm]	L [mm]	PCS PCS/BOX	
YT-1060	1/2" (12.7 mm)	17.5	25	75	40	160
YT-1061	1/2" (12.7 mm)	18.5	25	125	28	112
YT-1062	1/2" (12.7 mm)	20.0	25	250	30	60

EN Impact adapter
PL Redukcja udarowa
DE Reduktion
RU Переходник
CZ Redukce
HU Redukció
RO Reducție
FR Réduction
IT Prolunga per percussione
ES Reducción
CN 风动转换头

1/2" 12.7mm CrMo SCM440

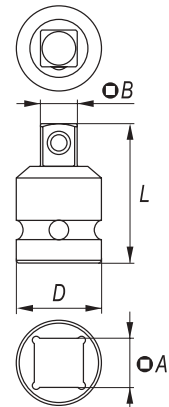

YATO	o	o	D [mm]	L [mm]	PCS PCS/BOX	
YT-1067	1/2" (12.7 mm) (F)	3/4" (19.0 mm) (M)	30	48	40	160

EN Impact universal joint
 PL Przegub kulisty udarowy
 DE Kraft-Kugelgelenk
 RU Ударный шаровой шарнир
 CZ Kulový rázový kloub
 HU Csuklós csatlakozó gépi
 RO Articulație universală de impact
 FR Joint universel à impact
 IT Giunto universale a impatto
 ES Junta de impacto universal
 CN 风动万向接头

1/2"
12.7mm
CrMo
SCM440



YATO	Ø	D1 [mm]	D2 [mm]	L [mm]	PCS PKG	
YT-1064	1/2" (12.7 mm)	31	17	63	25	100

EN Impact universal joint
 PL Przegub kulisty udarowy
 DE Kraft-Kugelgelenk
 RU Ударный шаровой шарнир
 CZ Kulový rázový kloub
 HU Csuklós csatlakozó gépi
 RO Articulație universală de impact
 FR Joint universel à impact
 IT Giunto universale a impatto
 ES Junta de impacto universal
 CN 重型气动万向接头

1/2"
12.7mm
CrMo
SCM440

FOR IMPACT
TOOLS
DO NARZĘDZI
UDAROWYCH



YATO	Ø	D1 [mm]	D2 [mm]	L [mm]	PCS PKG	
YT-10640	1/2" (12.7 mm)	31.2	16.7	63	10/100	

EN Hexagonal impact socket
 PL Nasadka udarowa sześciokątna
 DE Kraftschrauber-Einsatz
 RU Головка ударная 6-гранная
 CZ Šestihranný nástavec
 HU Gépi dugókulcs hatszög

RO Cheie tubulară hexagonală de impact
 FR Douille à choc
 IT Chiave a bussola esagonale per percussione
 ES Boquilla de percusión
 CN 风动套筒

3/4"
19mm
CrMo
SCM440
AS-DRIVE



YATO	Ø A [mm]	D1 [mm]	D2 [mm]	L [mm]	PCS PKG	
YT-1070	19	32	40	50	16	64
YT-1071	21	35	40	50	16	64
YT-1072	22	38	40	50	16	64
YT-1073	23	38	40	50	16	64
YT-1074	24	40	40	50	16	64
YT-1075	25	40	40	50	16	64
YT-1076	26	40	40	50	16	64
YT-1077	27	42	42	53	16	64
YT-1078	28	44	44	53	16	64
YT-1079	29	46	44	53	12	48
YT-1080	30	46	44	53	12	48
YT-1082	32	48	44	56	12	48
YT-1083	33	48	44	56	8	32
YT-1084	34	50	44	56	8	32
YT-1085	35	50	44	56	6	24
YT-1086	36	52	44	56	6	24
YT-1088	38	56	44	57	6	24
YT-1091	41	60	44	57	5	20
YT-1092	42	61	44	57	4	16
YT-1093	43	63	44	57	4	16
YT-1096	46	66	44	62	3	12
YT-1100	50	71	54	72	3	12
YT-1102	52	74	54	72	2	8
YT-1105	55	78	54	74	2	8
YT-1110	60	84	54	74	2	8

EN Hexagonal deep impact socket
 PL Nasadka udarowa sześciokątna długa
 DE Kraftschrauber-Einsatz, lang
 RU Головка ударная 6-гранная глубокая
 CZ Šestihranný hluboký nástavec
 HU Gépi dugókulcs hatszög hosszú

RO Cheie tubulară hexagonală de impact adâncă
 FR Douille profonde à choc
 IT Chiave a bussola esagonale per percussione
 ES Boquilla de percusión profunda
 CN 风动长套筒

3/4"
19mm
CrMo
SCM440
AS-DRIVE



YATO	Ø A [mm]	D1 [mm]	D2 [mm]	L [mm]	PCS PKG	
YT-1119	19	32	44	90	9	36
YT-1121	21	35	44	90	9	36
YT-1122	22	38	44	90	9	36
YT-1124	24	40	44	90	9	36
YT-1127	27	42	44	90	9	36
YT-1128	28	44	44	90	8	32
YT-1129	29	44	44	90	8	32
YT-1130	30	46	44	90	7	28
YT-1132	32	48	44	90	7	28
YT-1133	33	50	44	90	6	24
YT-1134	34	51	44	90	6	24
YT-1135	35	52	44	90	6	24
YT-1136	36	54	44	90	6	24
YT-1138	38	56	44	90	6	24
YT-1141	41	60	44	90	5	20
YT-1142	42	61	44	90	4	16
YT-1143	43	63	44	90	3	12
YT-1146	46	66	44	90	3	12
YT-1148	48	68	44	90	2	8
YT-1150	50	71	54	90	2	8

EN Impact socket set
PL Zestaw nasadek udarowych
DE Kraftschrauber-Einsätze
RU Набор торцевых ударных головок
CZ Sada úderových nástrčných hlavíc
HU Gépi dugókulcs készlet

RO Set chei tubulare pt. impact
FR Jeu de douilles à choc
IT Set di chiavi a bussola a percussione
ES Juego de vasos de impacto
CN 风动套筒组套

8
PCS

3/4"
19mm

CrMo
SCM440

AS-DRIVE



3/4" (19.0 mm): 22, 24 mm (L=50 mm); 27, 30 mm (L=53 mm); 32, 36 mm (L=55 mm); 38, 41 mm (L=57 mm)

YATO 	Ø	PCS
YT-1115	3/4" (19.0 mm)	6

EN Impact extension bar
PL Przedłużka udarowa
DE Verlängerung
RU Удлинитель ударный
CZ Prodlužovací příravek
HU Toldalék

RO Prelungitor
FR Rallonge
IT Prolunga per percussione
ES Tubo de prolongación
CN 风动接杆

3/4"
19mm

CrMo
SCM440

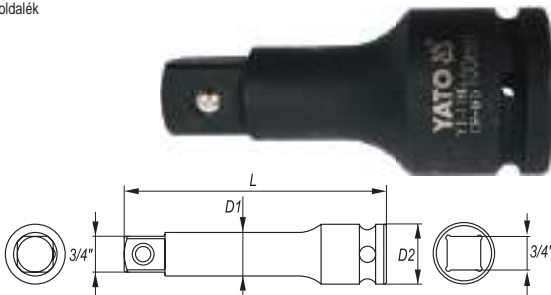
YATO 	Ø	D1 [mm]	D2 [mm]	L [mm]	PCS	FIGURE
YT-1160	3/4" (19.0 mm)	44	24	100	8	32
YT-1161	3/4" (19.0 mm)	44	24	175	10	20
YT-1162	3/4" (19.0 mm)	44	24	250	8	16
YT-1163	3/4" (19.0 mm)	44	24	330	6	12

EN Impact adapter
PL Redukcja udarowa
DE Reduktion
RU Переходник
CZ Redukce
HU Redukció
RO Reducție
FR Réduction
IT Prolunga per percussione
ES Reducción
CN 风动转换头

3/4"
19mm

CrMo
SCM440



YATO 	Ø	Ø	D [mm]	L [mm]	PCS	FIGURE
YT-1168	3/4" (19.0 mm) (F)	1" (25.4 mm) (M)	44	63	12	48

EN Impact universal joint
PL Przegub kulisty udarowy
DE Kraft-Kugelgelenk
RU Ударный шаровой шарнир
CZ Kulový rázový kloub
HU Csuklós csatlakozó gépi
RO Articulație universală de impact
FR Joint universel à impact
IT Giunto universale a impatto
ES Junta de impacto universal
CN 重型气动方向接头



EN Impact socket set
PL Zestaw nasadek udarowych
DE Kraftschrauber-Einsätze
RU Набор торцевых ударных головок
CZ Sada úderových nástrčných hlavíc
HU Gépi dugókulcs készlet

RO Set chei tubulare pt. impact
FR Jeu de douilles à choc
IT Set di chiavi a bussola a percussione
ES Juego de vasos de impacto
CN 风动套筒组套

8
PCS

3/4"
19mm

CrMo
SCM440

AS-DRIVE



3/4" (19.0 mm): 22, 24, 27, 30, 32, 36, 38, 41 mm (L=90 mm)

YATO 	Ø	PCS
YT-1155	3/4" (19.0 mm)	4

EN Impact adapter
PL Redukcja udarowa
DE Reduktion
RU Переходник
CZ Redukce
HU Redukció
RO Reducție
FR Réduction
IT Prolunga per percussione
ES Reducción
CN 转接头

3/4"
19mm

CrV
50BV30



YATO 	Ø	Ø	D [mm]	L [mm]	PCS	FIGURE
YT-11671	3/4" (19.0 mm) (F)	1/2" (12.7 mm) (M)	44	55	12	48

EN Impact universal joint
PL Przegub kulisty udarowy
DE Kraft-Kugelgelenk
RU Ударный шаровой шарнир
CZ Kulový rázový kloub
HU Csuklós csatlakozó gépi

RO Articulație universală de impact
FR Joint universel à impact
IT Giunto universale a impatto
ES Junta de impacto universal
CN 风动方向接头

3/4"
19mm

CrMo
SCM440





YATO 	Ø	D1 [mm]	D2 [mm]	L [mm]	PCS	FIGURE
YT-1164	3/4" (19.0 mm)	31	44	102	8	32

3/4"
19mm

CrMo
SCM440

FOR IMPACT TOOLS DO NARZĘDZI UDAROWYCH 

YATO 	Ø	D1 [mm]	D2 [mm]	L [mm]	PCS
YT-11641	3/4" (19.0 mm)	45.6	25.3	93.3	5/20

EN Hexagonal impact socket
 PL Nasadka uderowa sześciokątna
 DE Kraftschrauber-Einsatz
 RU Головка ударная 6-гранная
 CZ Šestihřanný nástavec
 HU Gépi dugókulcs hatszög

RO Cheie tubulară hexagonală de impact
 FR Douille à choc
 IT Chiave a bussola esagonale per percussione
 ES Boquilla de percusión
 CN 风动套筒

1"
25 mm
CrMo
SCM440
AS-DRIVE

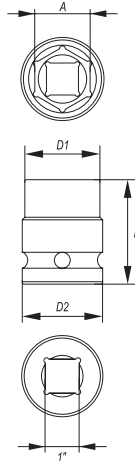

YATO	○ A [mm]	D1 [mm]	D2 [mm]	L [mm]	PCS PKG	
YT-1180	24	42	54	59	6	24
YT-1183	27	46	54	59	6	24
YT-1184	28	47	54	59	6	24
YT-1185	29	48	54	60	6	24
YT-1186	30	49	54	60	6	24
YT-1187	32	52	54	61	6	24
YT-1188	33	53	54	61	6	24
YT-1189	34	54	54	61	6	24
YT-1191	36	57	54	65	6	24
YT-1193	38	60	54	65	5	20
YT-1194	41	63	54	65	4	16
YT-1196	46	69	54	73	3	12
YT-1197	48	72	54	73	2	8
YT-1198	50	75	54	73	2	8

EN Hexagonal deep impact socket
 PL Nasadka uderowa sześciokątna długa
 DE Kraftschrauber-Einsatz, lang
 RU Головка ударная 6-гранная глубокая
 CZ Šestihřanný hluboký nástavec
 HU Gépi dugókulcs hatszög hosszú

RO Cheie tubulară hexagonală de impact adâncă
 FR Douille profonde à choc
 IT Chiave a bussola esagonale per percussione
 ES Boquilla de percusión profunda
 CN 风动长套筒

1"
25 mm
CrMo
SCM440
AS-DRIVE

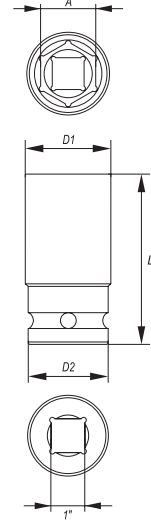

YATO	○ A [mm]	D1 [mm]	D2 [mm]	L [mm]	PCS PKG	
YT-1175	27	46	54	90	6	24
YT-1176	30	50	54	90	6	24
YT-1177	32	52	54	90	6	24
YT-1178	33	54	54	90	6	24
YT-1179	36	57	54	90	6	24

EN Impact extension bar with adapter
 PL Przedłużka uderowa z redukcją
 DE Verlängerung mit Adapter
 RU Удлинитель с редукцией
 CZ Prodloužení s redukcí
 HU Hosszabbító szár adapterrel

RO Bara extensie cu adaptor
 FR Rallonge avec réduction
 IT Prolunga per percussionecon riduttore
 ES Tubo de prolongación con reductor
 CN 风动转换接头



1"
25 mm
CrMo
SCM440

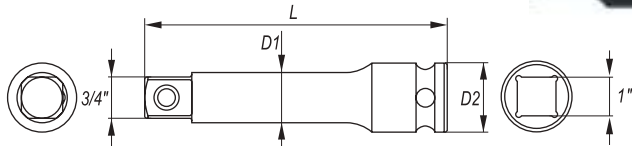

YATO	○ A	○ B	D1 [mm]	D2 [mm]	L [mm]	PCS PKG	
YT-1169	1" (25.4 mm) (F)	3/4" (19.0 mm) (M)	53	33	250	6	12

EN Impact universal joint
 PL Przegub kulisty uderowy
 DE Kraft-Kugelgelenk
 RU Ударный шаровой шарнир
 CZ Kulový rázový kloub
 HU Csuklós csatlakozó gépi
 RO Articulație universală de impact
 FR Joint universel à impact
 IT Giunto universale a impatto
 ES Junta de impacto universal
 CN 重型气动万向接头

1"
25 mm
CrMo
SCM440
FOR IMPACT
TOOLS
DO NARZĘDZI
UDAROWYCH

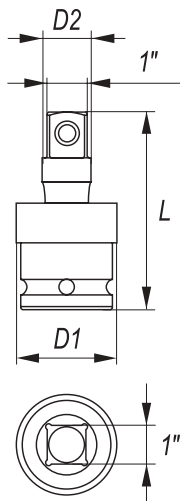

YATO	○	D1 [mm]	D2 [mm]	L [mm]	
YT-11999	1" (25.4 mm)	54.3	33.9	110	3/12

EN Adaptor set
 PL Zestaw redukcji
 DE Reduktionsset
 RU Редукционный комплект
 CZ Redukční sada
 HU Adapter készlet

RO Set adaptoare
 FR Ensemble de réducteurs pour douilles
 IT Kit di riduzioni
 ES Set de reductores
 CN 气动转换接头组套

6
PCS
CrV



3/8" (9.5 mm) (M) x 1/4" (6.3 mm) (F), 1/4" (6.3 mm) (M) x 3/8" (9.5 mm) (F), 3/8" (9.5 mm) (F) x 1/2" (12.7 mm) (M), 1/2" (12.7 mm) (F) x 3/8" (9.5 mm) (M), 3/4" (19.0 mm) (M) x 1/2" (12.7 mm) (F), 1/2" (12.7 mm) (M) x 3/4" (19.0 mm) (F)

YATO	
YT-10671	20

EN Impact universal joint set
PL Zestaw przegubów udarowych
DE Kugelgelenk-Satz
RU Набор ударных шаровых шарниров
CZ Sada kulových rázových kloubů
HU Gépi csuklós csatlakozó készlet
RO Set articulatii universale de impact
FR Jeu de joints à impact
IT Kit di giunti universali a impatto
ES Conjunto de juntas de impacto
CN 重型气动万向接头组套



3 PCS
1/2" 12.7mm
3/8" 9.5mm
1/4" 6.3mm
CrMo

EN Impact universal joint set
PL Zestaw przegubów udarowych
DE Kugelgelenk-Satz
RU Набор ударных шаровых шарниров
CZ Sada kulových rázových kloubů
HU Gépi csuklós csatlakozó készlet
RO Set articulatii universale de impact
FR Jeu de joints à impact
IT Kit di giunti universali a impatto
ES Conjunto de juntas de impacto
CN 重型气动万向接头组套



3 PCS
1/2" 12.7mm
3/8" 9.5mm
1/4" 6.3mm
CrMo SCM440
FOR IMPACT TOOLS DO HARZEDZI UDAROWYCH

YATO	○	
YT-10643	1/4" (6.3 mm), 3/8" (9.5 mm), 1/2" (12.7 mm)	10/60

YATO	○	
YT-10642	1/4" (6.3 mm), 3/8" (9.5 mm), 1/2" (12.7 mm)	5/20

EN Hexagonal impact socket
PL Nasadka udarowa sześciokątna
DE Kraftschrauber-Einsatz
RU Головка ударная 6-гранная
CZ Šestihranný nástavec
HU Gépi dugókulcs hatszög
RO Cheie tubulară hexagonală de impact
FR Douille à choc
IT Chiave a bussola esagonale per percussione
ES Boquilla de percusión
CN 风动套筒

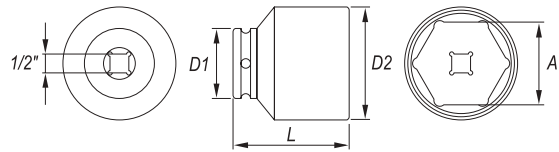

1/2" 12.7mm
FOR FRONT HUB NUTS DO PIAST PRZEDNICH
CrMo SCM440
AS-DRIVE

YATO	○ A [mm]	D1 [mm]	D2 [mm]	L [mm]	PCS ROZE	
YT-1029	52	44	71	72	3	12

EN Bi-hexagonal impact socket
PL Nasadka udarowa dwunastokątna
DE Zwölfkant-Kraftschrauber-Einsatz
RU Головка ударная 12-гранная
CZ Vanáctihranný nástavec
HU Gépi dugókulcs 12-szögű
RO Cheie tubulară bihexagonală de impact
FR Douille à choc
IT Chiave a bussola esagonale per percussione
ES Boquilla bihexagonal de percusión
CN 风动套筒

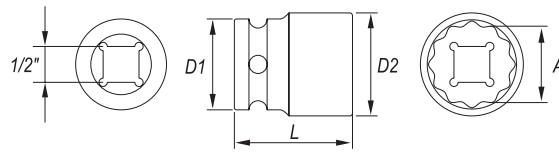

1/2" 12.7mm
FOR FRONT HUB NUTS DO PIAST PRZEDNICH
CrMo SCM440
AS-DRIVE

YATO	○ A [mm]	D1 [mm]	D2 [mm]	L [mm]	PCS ROZE	
YT-1027	24	30	34	39	10	120

EN Bi-hexagonal impact socket
PL Nasadka udarowa dwunastokątna
DE Zwölfkant-Kraftschrauber-Einsatz
RU Головка ударная 12-гранная
CZ Vanáctihranný nástavec
HU Gépi dugókulcs 12-szögű
RO Cheie tubulară bihexagonală de impact
FR Douille à choc
IT Chiave a bussola esagonale per percussione
ES Boquilla bihexagonal de percusión
CN 风动套筒

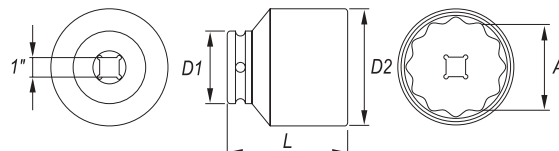

1" 25mm
FOR FRONT HUB NUTS DO PIAST PRZEDNICH
HRC 38-45
CrMo

YATO	○ A [mm]	D1 [mm]	D2 [mm]	L [mm]	
YT-11990	65	54	93	93	4
YT-11995	80	86	112	100	4
YT-11998	85	86	118	102	4

EN Impact bit socket set
PL Zestaw udarowych kluczy trzpieniowych
DE Schlagsteckschlüsselsatz
RU Набор ударных торцовых ключей
CZ Souprava rázových zástrčných klíčů
HU Üthető bit dugókulcs készlet
RO Set chei de șoc cu bolt
FR Jeu de douilles à impact
IT Set di chiavi a bussola per percussione
ES Juego de llaves de mandril de impacto
CN 气动一体批组套



6 PCS
1/2" 12.7mm
CrMo

○ □ □ 1/2" (12.7 mm): M14, M16, M18 (L=43 mm); M14, M16, M18 (L=78 mm)

YATO	○	
YT-10652	1/2" (12.7 mm)	20

EN Impact bit socket set
PL Zestaw udarowych kluczy trzpieniowych
DE Schlagsteckschlüsselsatz
RU Набор ударных торцовых ключей
CZ Souprava rázových zástrčných klíčů
HU Üthető bit dugókulcs készlet

RO Set chei de șoc cu bolt
FR Jeu de douilles à impact
IT Set di chiavi a bussola per percussione
ES Juego de llaves de mandril de impacto
CN 气动一体批组套



9 PCS
1/2" 12.7mm
CrMo

○ □ □ 1/2" (12.7 mm): T20, T25, T30, T40, T45, T50, T55, T60, T70

YATO	○	
YT-10654	1/2" (12.7 mm)	10

EN Impact bit socket set
 PL Zestaw uderowych kluczy trzpieniowych
 DE Schlagsteckschlüsselsatz
 RU Набор ударных торцовых ключей
 CZ Souprava rázových zástrčných klíčů
 HU Üthető bit dugókulcs készlet

RO Set chei de șoc cu bolt
 FR Jeu de douilles à impact
 IT Set di chiavi a bussola per percussione
 ES Juego de llaves de mandril de impacto
 CN 气动一体批组套

9
PCS



1/2"
12.7mm

CrMo



1/2" (12.7 mm): RM5, RM6, RM7, RM8, RM9, RM10, RM12, RM13, RM14

YATO	○	
YT-10681	1/2" (12.7 mm)	10

EN Impact bit socket set
 PL Zestaw uderowych kluczy trzpieniowych
 DE Schlagsteckschlüsselsatz
 RU Набор ударных торцовых ключей
 CZ Souprava rázových zástrčných klíčů
 HU Üthető dugókulcs bit - készlet
 RO Set chei de șoc cu bolt
 FR Set de douilles à choc
 IT Set di chiavi a bussola per percussione
 ES Juego de llaves de mandril de impacto
 CN 气动套筒批头组套

8
PCS

1/2"
12.7mm

HRC
54

CrMo



1/2" (12.7 mm): T30, T40, T45, T50, T55, T60, T70, T80

YATO	○	
YT-1065	1/2" (12.7 mm)	15



1/2" (12.7 mm): 6, 7, 8, 10, 12, 14, 17, 19 mm

YATO	○	
YT-1066	1/2" (12.7 mm)	15



1/2" (12.7 mm): RM5, RM6, RM7, RM8, RM10, RM11, RM12, RM13

YATO	○	
YT-1068	1/2" (12.7 mm)	15



1/2" (12.7 mm): M5, M6, M8, M10, M12, M14, M16, M18

YATO	○	
YT-1069	1/2" (12.7 mm)	15

EN Impact bit socket set
 PL Zestaw uderowych kluczy trzpieniowych
 DE Schlagsteckschlüsselsatz
 RU Набор ударных торцовых ключей
 CZ Souprava rázových zástrčných klíčů
 HU Üthető bit dugókulcs készlet

RO Set chei de șoc cu bolt
 FR Jeu de douilles à impact
 IT Set di chiavi a bussola per percussione
 ES Juego de llaves de mandril de impacto
 CN 气动一体批组套

9
PCS



1/2"
12.7mm

CrMo



1/2" (12.7 mm): M4, M5, M6, M8, M9, M10, M12, M14, M16

YATO	○	
YT-10691	1/2" (12.7 mm)	10

EN Impact bit with holder set
 PL Zestaw uderowych kluczy trzpieniowych z nasadką
 DE Schlagschrauber-Steckschlüsselsatz mit Schutzkappe
 RU Набор ударных ключей с торцевыми головками
 CZ Sada imbusových nástrčných klíčů
 HU Gépi hatlapú dugókulcs készlet
 RO Set biti si adaptor impact
 FR Jeu de clés à choc avec douille
 IT Set di chiavi a brugola con punta
 ES Juego de llaves de vaso de impacto
 CN M型冲击批头组套

9
PCS

1/2"
12.7mm

CrMo

S2



1/2" (12.7 mm): T30, T40, T45, T47, T50, T55, T60, T70; (L=35 mm)

YATO	○	
YT-10664	1/2" (12.7 mm)	6/36



1/2" (12.7 mm): 6, 7, 8, 10, 12, 14, 17, 19 mm; (L=35 mm)

YATO	○	
YT-10662	1/2" (12.7 mm)	6/36





1/2" (12.7 mm): M6, M8, M9, M10, M12, M14, M16, M18; (L=35 mm)

YATO	○	
YT-10663	1/2" (12.7 mm)	6/36

- EN Spline impact bit set
- PL Zestaw bitów udarowych Spline
- DE Schlagwerkzeugsatz Spline
- RU Набор ударных битов Spline
- CZ Souprava bitů pro rázové utahováky Spline
- HU Útő bit készlet Spline
- RO Set tubulare de impact
- FR Set d'embouts à choc
- IT Set di chiavi a bussola per percussione Spline
- ES Juego de las piezas de percusión Spline
- CN 风动花键批头组套



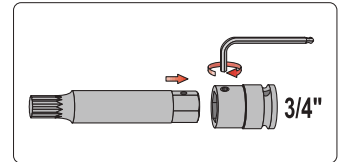

6 PCS	
3/4" 19mm	CrMo
	



 M12, M14, M16, M18 x 22 mm; (L=107 mm); CrMo;

 3/4" (19 mm) x 22 mm; CrMo;



YATO 		
YT-1157	3/4" (19.0 mm)	8



- EN Impact bit socket set
- PL Zestaw udarowych kluczy trzpieniowych
- DE Schlagsteckschlüsselsatz
- RU Набор ударных торцовых ключей
- CZ Souprava rázových zástrčných klíčů
- HU Úthető bit dugókulcs készlet
- RO Set chei de șoc cu bolt
- FR Jeu de douilles à impact
- IT Set di chiavi a bussola per percussione
- ES Juego de llaves de mandril de impacto
- CN 气动一体批组套



6 PCS	
3/4" 19mm	CrMo
	

 3/4" (19.0 mm); M16, M18;

 3/4" (19.0 mm); T70, T80, T90, T100

YATO 		
YT-10653	3/4" (19.0 mm)	10

- EN Impact bit socket set
- PL Zestaw udarowych kluczy trzpieniowych
- DE Schlagsteckschlüsselsatz
- RU Набор ударных торцовых ключей
- CZ Souprava rázových zástrčných klíčů
- HU Úthető bit dugókulcs készlet
- RO Set chei de șoc cu bolt
- FR Jeu de douilles à impact
- IT Set di chiavi a bussola per percussione
- ES Juego de llaves de mandril de impacto
- CN 气动套筒组套



12 PCS	1/2" 12.7mm
3/4" 19mm	CrMo
FOR TRUCKS DO AUT CIEZAROWYCH	
	

 3/4" (19 mm) (F); CrMo;



 1/2" (12.7 mm) (M); CrMo;

 3/4" (19 mm) (M) (L=200 mm); CrMo;

 T70, T80, T90, T100 (L=67 mm); CrMo;

 14, 17, 19, 21, 22 mm (L=67 mm); CrMo;

 3 mm

YATO 		
YT-10655	1/2" (12.7 mm), 3/4" (19.0 mm)	5

4

**Torque wrenches
& torque multipliers
Klucze dynamometryczne
i wzmacniacze momentu**



Torque wrenches

Klucze dynamometryczne

72-74



Torque multipliers

Wzmacniacze momentu

74



Beam torque wrenches

Klucze dynamometryczne wychylne..... 72

Torque wrenches with metal handle

Klucze dynamometryczne z metalową rączką..... 72

Torque wrenches with plastic handle

Klucze dynamometryczne z plastikową rączką..... 72

Dial torque wrenches

Klucze dynamometryczne zegarowe..... 74

EN Beam torque wrench
 PL Klucz dynamometryczny wychylny
 DE Beam-Typ-Drehmomentschlüssel

RU Ключ динамометрический стрелочный
 CZ Dynamometrický klíč
 HU Nyomatékkulcs

RO Cheie cu dinamometru
 FR Clé dynamométrique inclinée
 IT Chiave dinamometrica a quadrante

ES Llave dinamométrica inclin
 CN 扭力扳手

1/2"
12.7mm

3/4"
19mm

CrV
6140



YATO	Ø	[Nm]	
YT-07641	1/2" (12.7 mm)	0-300	16
YT-07642	3/4" (19.0 mm)	0-500	9

4

EN Torque wrench
 PL Klucz dynamometryczny
 DE Drehmomentschlüssel

RU Ключ динамометрический
 CZ Dynamometrický klíč
 HU Nyomatékkulcs

RO Cheie cu dinamometru
 FR Clé dynamométrique
 IT Chiave dinamometrica

ES Llave dinamométrica
 CN 传统型可调式扭力扳手

3/8"
9.5mm

1/2"
12.7mm

CrV
6140

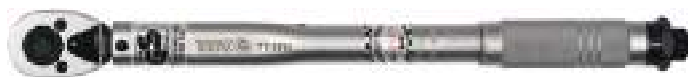
YATO	Ø	[Nm]	L [mm]	
YT-0750	3/8" (9.5 mm)	20-110	342-360	20
YT-0760	1/2" (12.7 mm)	42-210	445-465	12

EN Torque wrench
 PL Klucz dynamometryczny
 DE Drehmomentschlüssel

RU Ключ динамометрический
 CZ Dynamometrický klíč
 HU Nyomatékkulcs

RO Cheie cu dinamometru
 FR Clé dynamométrique
 IT Chiave dinamometrica

ES Llave dinamométrica
 CN 扭力扳手

3/8"
9.5mm

10-60
Nm

378-400
mm

+/-
CW 4%
CCW 4%

ALLOY STEEL
STAL
STOPOWA



YATO	Ø	[Nm]	L [mm]	
YT-07500	3/8" (9.5 mm)	10-60	378-400	12

EN Torque wrench
 PL Klucz dynamometryczny
 DE Drehmomentschlüssel

RU Ключ динамометрический
 CZ Dynamometrický klíč
 HU Nyomatékkulcs

RO Cheie cu dinamometru
 FR Clé dynamométrique
 IT Chiave dinamometrica

ES Llave dinamométrica
 CN 扭力扳手

1/4"
6.3mm

1/2"
12.7mm

3/4"
19mm

+/-
4%

ALLOY STEEL
STAL
STOPOWA



YATO	Ø	[Nm]	L [mm]	
YT-07511	1/4" (6.3 mm)	2.5-20	240-250	16
YT-07611	1/2" (12.7 mm)	10-60	378-400	12
YT-07601	1/2" (12.7 mm)	65-335	518-540	10
YT-07712	3/4" (19.0 mm)	80-400	676-697	4

EN Torque wrench
 PL Klucz dynamometryczny
 DE Drehmomentschlüssel

RU Ключ динамометрический
 CZ Dynamometrický klíč
 HU Nyomatékkulcs

RO Cheie cu dinamometru
 FR Clé dynamométrique
 IT Chiave dinamometrica

ES Llave dinamométrica
 CN 视窗可调式扭力扳手

3/8"
9.5mm

1/2"
12.7mm

SETTINGS WINDOW
OKNO
USTAWIEN

+/-
CW 4%
CCW 4%

CrMo
42



YATO	Ø	[Nm]	L [mm]	
YT-07735	3/8" (9.5 mm)	10-60	415	10
YT-07736	3/8" (9.5 mm)	10-100	470	10
YT-07612	1/2" (12.7 mm)	10-60	415	12
YT-07607	1/2" (12.7 mm)	10-100	470	10
YT-07605	1/2" (12.7 mm)	20-220	481	10
YT-07609	1/2" (12.7 mm)	65-350	550	10

EN Torque wrench
 PL Klucz dynamometryczny
 DE Drehmomentschlüssel

RU Ключ динамометрический
 CZ Dynamometrický klíč
 HU Nyomatékkulcs

RO Cheie cu dinamometru
 FR Clé dynamométrique
 IT Chiave dinamometrica

ES Llave dinamométrica
 CN 省力型可调式扭力扳手

1/4"
6.3mm

CrV
6140



YATO	Ø	[Nm]	L [mm]	
YT-0751	1/4" (6.3 mm)	2-10	268-278	24

EN Torque wrench
 PL Klucz dynamometryczny
 DE Drehmomentschlüssel

RU Ключ динамометрический
 CZ Dynamometrický klíč
 HU Nyomatékkulcs

RO Cheie cu dinamometru
 FR Clé dynamométrique
 IT Chiave dinamometrica

ES Llave dinamométrica
 CN 扭力扳手

3/8"
9.5mm

+/-
CW 3%
CCW 3%

CrMo
3042





YATO	Ø	[Nm]	L [mm]	
YT-07730	3/8" (9.5 mm)	6-30	295-316	12
YT-07731	3/8" (9.5 mm)	10-60	362-385	12

EN Torque wrench RU Ключ динамометрический RO Cheie cu dinamometru ES Llave dinamométrica
 PL Klucz dynamometryczny CZ Dynamometrický klíč FR Clé dynamométrique CN 扭力扳手
 DE Drehmomentschlüssel HU Nyomatékkulcs IT Chiave dinamometrica

1/2"
12.7mm +/-
CW 3%
CCW 3% **CrMo**
3042 





YATO 	Ø	[Nm]	L [mm]	
YT-07740	1/2" (12.7 mm)	10-60	360-385	12
YT-07741	1/2" (12.7 mm)	20-100	420-440	12
YT-07743	1/2" (12.7 mm)	40-200	445-465	12

EN Torque wrench RU Ключ динамометрический RO Cheie cu dinamometru ES Llave dinamométrica
 PL Klucz dynamometryczny CZ Dynamometrický klíč FR Clé dynamométrique CN 扭力扳手
 DE Drehmomentschlüssel HU Nyomatékkulcs IT Chiave dinamometrica

3/4"
19mm 1030
x1050
mm ≤500 Nm
+/- 3%
CW CCW >500 Nm
+/- 4%
CW CCW **CrMo**
3042 



YATO 	Ø	[Nm]	L [mm]	
YT-07752	3/4" (19.0 mm)	160-800	1030-1050	2
YT-07753	3/4" (19.0 mm)	200-1000	1030-1050	2

EN Torque wrench CZ Dynamometrický klíč IT Chiave dinamometrica
 PL Klucz dynamometryczny HU Nyomatékkulcs ES Llave dinamométrica
 DE Drehmomentschlüssel RO Cheie cu dinamometru CN 扭力扳手
 RU Ключ динамометрический FR Clé dynamométrique

1"
25mm 300-1500
Nm 2160-2190
mm ≤500 Nm
+/- 3%
CW CCW >500 Nm
+/- 4%
CW CCW **CrMo**
3042 





YATO 	Ø	[Nm]	L [mm]	
YT-07762	1" (25.4 mm)	300-1500	2160-2190	1

EN Torque wrench RU Ключ динамометрический RO Cheie cu dinamometru ES Llave dinamométrica
 PL Klucz dynamometryczny CZ Dynamometrický klíč FR Clé dynamométrique CN 可調式扭力扳手
 DE Drehmomentschlüssel HU Nyomatékkulcs IT Chiave dinamometrica

3/4"
19mm **1/2"**
12.7mm **CrV**
6140 





YATO 	Ø	[Nm]	L [mm]	
YT-0761	1/2" (12.7 mm)	40-210	516-534	10
YT-0770	3/4" (19.0 mm)	100-500	845-860	4
YT-0771	3/4" (19.0 mm)	140-980	1215-1230	2

EN Torque wrench RU Ключ динамометрический RO Cheie cu dinamometru ES Llave dinamométrica
 PL Klucz dynamometryczny CZ Dynamometrický klíč FR Clé dynamométrique CN 省力型可調式扭力扳手
 DE Drehmomentschlüssel HU Nyomatékkulcs IT Chiave dinamometrica

1/2"
12.7mm **CrV**
6140 





YATO 	Ø	[Nm]	L [mm]	
YT-0754	1/2" (12.7 mm)	60-340	592-613	10

EN Torque wrench RU Ключ динамометрический RO Cheie cu dinamometru ES Llave dinamométrica
 PL Klucz dynamometryczny CZ Dynamometrický klíč FR Clé dynamométrique CN 扭力扳手
 DE Drehmomentschlüssel HU Nyomatékkulcs IT Chiave dinamometrica

3/4"
19mm 150-800
Nm +/-
CW 3%
CCW 5% **HRC**
48-52 **CrV**
6140 



YATO 	Ø	[Nm]	L [mm]	
YT-07711	3/4" (19.0 mm)	150-800	1155-1175	2

EN Dial torque wrench
 PL Zegarowy klucz dynamometryczny
 DE Drehmomentschlüssel mit Skalenmessuhr
 RU Стрелочный динамометрический ключ

CZ Momentový klíč s kruhovou stupnicí
 HU Mérőárcsás nyomatékkulcs
 RO Cheie dinamometrică cu ceas
 FR Clé dynamométrique avec horloge

IT Chiave dinamometrica a orologio
 ES Llave dinamométrica con reloj
 CN 扭力扳手



1/4"
6.3 mm

3/8"
9.5 mm

1/2"
12.7 mm

+/-
3%



YATO 	Ø	[Nm]	L [mm]	
YT-07830	1/4" (6.3 mm)	0.5-5	335	12
YT-07831	1/4" (6.3 mm)	1-10	335	12
YT-07832	3/8" (9.5 mm)	3-30	335	12

4

EN Dial torque wrench
 PL Zegarowy klucz dynamometryczny
 DE Drehmomentschlüssel mit Skalenmessuhr
 RU Стрелочный динамометрический ключ



CZ Momentový klíč s kruhovou stupnicí
 HU Mérőárcsás nyomatékkulcs
 RO Cheie dinamometrică cu ceas
 FR Clé dynamométrique avec horloge

IT Chiave dinamometrica a orologio
 ES Llave dinamométrica con reloj
 CN 扭力扳手

1/2"
12.7 mm

+/-
3%



YATO 	Ø	[Nm]	L [mm]	
YT-07835	1/2" (12.7 mm)	20-200	490	10
YT-07836	1/2" (12.7 mm)	30-300	590	10

EN Torque multiplier
 PL Mechaniczny wzmacniacz momentu
 DE Drehmomentverstärker
 RU Мультипликатор крутящего момента
 CZ Mechanický posilovač momentu
 HU Nyomaték sokszorozó
 RO Antrenor cu amplifi cator de forta
 FR Amplifi cateur de couple mécanique
 IT Moltiplicatore di coppia
 ES Mecanismo de reforzar el momento
 CN 扭力倍增器

1"
25 mm



330 mm

4200 Nm (max.)

I-1:3.8
II-1:58

CrV



YATO 	Ø	Tmax. [Nm]	L [mm]	
YT-0782	1" (25.4 mm)	4200	330	1

EN Torque multiplier
 PL Mechaniczny wzmacniacz momentu
 DE Drehmomentverstärker
 RU Мультипликатор крутящего момента
 CZ Mechanický posilovač momentu
 HU Nyomaték sokszorozó
 RO Antrenor cu amplifi cator de forta
 FR Amplifi cateur de couple mécanique
 IT Moltiplicatore di coppia
 ES Mecanismo de reforzar el momento
 CN 扭矩倍增器

1"
25 mm



380 mm

5800 Nm (max.)

1:66

CrV



YATO 	Ø	Tmax. [Nm]	L [mm]	
YT-07822	1" (25.4 mm)	5800	380	1

Memo

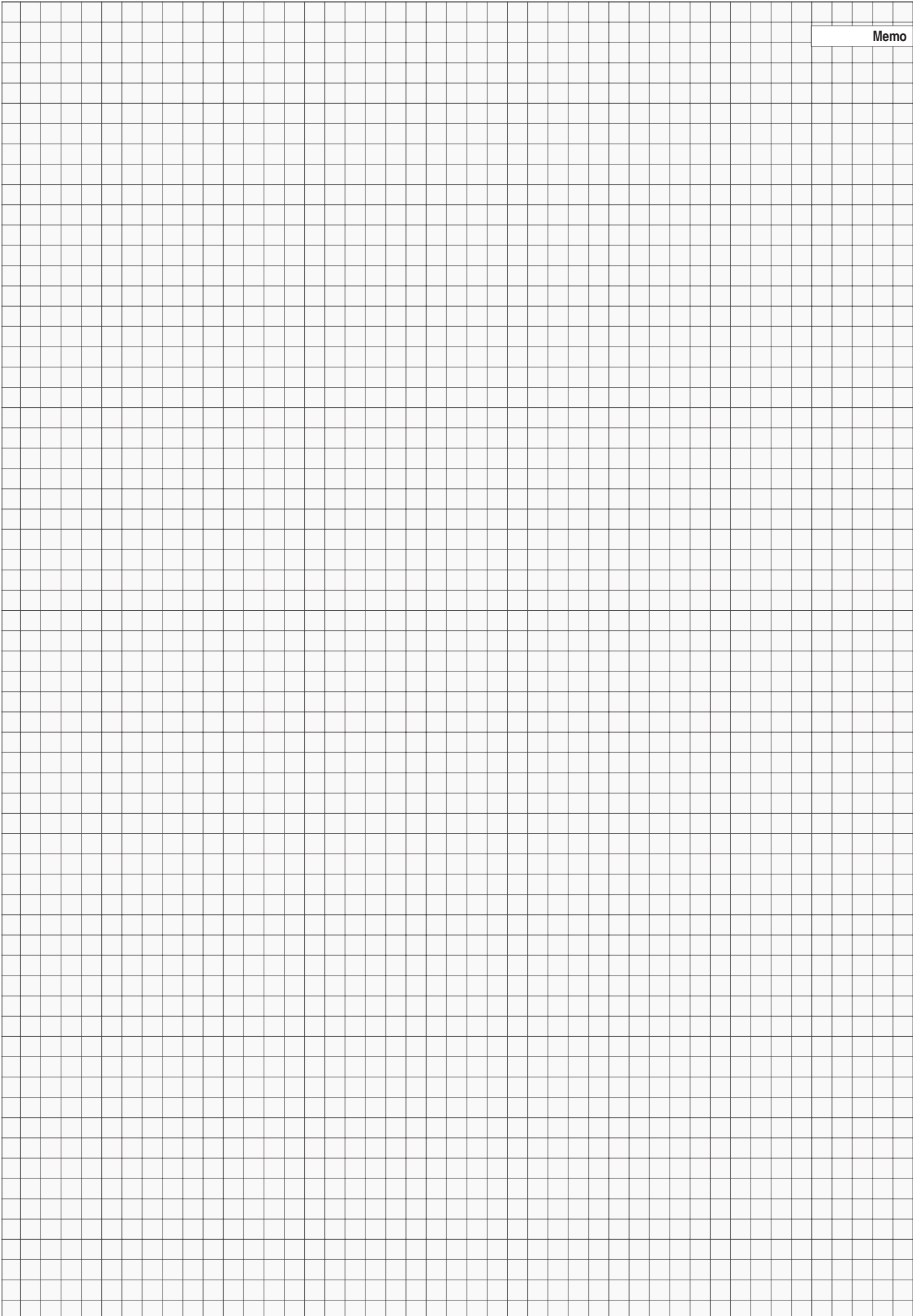

5

**Screwdrivers
& screwdriver bits**
**Wkrętaki i końcówki
wkrętakowe**



Screwdrivers, 3 color handle
Wkrętaki, trójkolorowa rączka

78-80



Slotted screwdrivers

Wkrętaki płaskie

78

Phillips screwdrivers

Wkrętaki krzyżakowe

78

Pozidrive screwdrivers

Wkrętaki „Pozidrive”

78

Torx screwdrivers

Wkrętaki „Torx”

78

Torx Security screwdrivers

Wkrętaki „Torx Security”

78

Go-through screwdrivers

Wkrętaki do pobijania

78

Screwdriver sets

Komplety wkrętaków

79

Screwdriver bits
Kończówki wkrętakowe

84-91



Phillips screwdriver bits

Kończówki wkrętakowe krzyżakowe

84

Torx screwdriver bits

Kończówki wkrętakowe „Torx”

84

YATO NON-SLIP SYSTEM screwdriver bits

Kończówki wkrętakowe „YATO NON-SLIP SYSTEM”

84

Screwdriver bit sets

Zestawy końcówek wkrętakowych

87

Nut setters

Nasadki magnetyczne do wkrętarek

91



Screwdrivers, 3 color handle
Wkrętaki, trójkolorowa rączka

80



Screwdriver sets

Komplety wkrętaków

80

Screwdriver bit holders

Uchwyty do końcówek wkrętakowych

91-94



Hex & Torx keys & sets

Klucze imbusowe i zestawy

95-101



Precision screwdrivers, 3 color handle

Wkrętaki precyzyjne, trójkolorowa rączka

81



Precision slotted screwdrivers

Wkrętaki precyzyjne płaskie

81

Precision phillips screwdrivers

Wkrętaki precyzyjne krzyżakowe

81

Precision Torx screwdrivers

Wkrętaki precyzyjne „Torx”

81

Precision screwdriver sets

Zestawy wkrętaków precyzyjnych

81

T-handle keys & sets

Klucze imbusowe typu „T” i zestawy

95

Hex keys & sets

Klucze imbusowe i zestawy

96

Torx & Torx Security keys & sets

Klucze „Torx”, „Torx Security” i zestawy

97

Plastic covered hex & Torx Security keys

Klucze imbusowe powlekane

101

Special screwdrivers & impact screwdrivers

Wkrętaki specjalne i udarowe

82-83



Ratchet screwdriver sets

Wkrętaki z grzechotką

82

Impact screwdrivers

Wkrętaki udarowe



83

EN Screwdriver CZ Šroubovák IT Cacciavite
 PL Wkrętek HU Csavarhúzó ES Destornillador
 DE Schraubendreher RO Șurubelniță CN 一字螺丝批
 RU Отвёртка FR Tournevis





5





YATO 	⊖ [mm]	L [mm]	PCS PKG	
YT-25900	2	75	12	96/384
YT-25901	3	75	12	96/384
YT-25902	3	100	12	96/384
YT-25903	3	150	12	60/240
YT-25904	4	100	12	96/384
YT-25905	4	150	12	96/384
YT-25906	4	200	12	96/384
YT-25907	5	75	12	60/240
YT-25908	5	100	12	60/240
YT-25909	5	150	12	60/240
YT-25910	6	38	12	60/240
YT-25911	6	100	12	36/144
YT-25912	6	150	12	36/144
YT-25913	6	200	12	36/144
YT-25914	8	150	6	24/96





YATO 	⊕	L [mm]	PCS PKG	
YT-25920	PH0	75	12	96/384
YT-25921	PH0	100	12	96/384
YT-25922	PH1	38	12	60/240
YT-25923	PH1	75	12	60/240
YT-25924	PH1	100	12	60/240
YT-25925	PH1	150	12	60/240
YT-25926	PH1	200	12	36/144
YT-25927	PH1	300	6	24/96
YT-25928	PH2	38	12	60/240
YT-25929	PH2	100	12	36/144
YT-25930	PH2	150	12	36/144
YT-25931	PH2	200	12	36/144
YT-25932	PH2	300	6	24/96
YT-25933	PH3	150	6	24/96
YT-25934	PH3	200	6	24/96





YATO 	⊕	L [mm]	PCS PKG	
YT-25940	PZ1	75	12	60/240
YT-25941	PZ1	100	12	60/240
YT-25942	PZ2	100	12	36/144
YT-25943	PZ2	150	12	36/144





YATO 	⊗	L [mm]	PCS PKG	
YT-25950	T5	75	12	96/384
YT-25951	T6	75	12	96/384





YATO 	⊗	L [mm]	PCS PKG	
YT-25952	T7	75	12	96/384
YT-25953	T8	75	12	96/384
YT-25954	T9	75	12	96/384
YT-25955	T10	100	12	60/240
YT-25956	T15	100	12	60/240
YT-25957	T20	100	12	60/240
YT-25958	T25	100	12	36/144
YT-25959	T27	100	12	36/144
YT-25960	T30	100	12	36/144
YT-25961	T40	100	6	24/96

EN Go-through screwdriver RU Отвёртка-бипо RO Șurubelniță pt. fixare ES Destornillador para dar golpes
 PL Wkrętek do pobijania CZ Šroubovák s úderným koncem FR Tournevis à frapper CN 一字敲击螺丝批
 DE Schlagschrauber HU Beütő csavarhúzó IT Cacciaviti per viti con intaglio



YATO 	⊕	L [mm]	PCS PKG	
YT-25993	PH2	100	6	24/96
YT-25994	PH2	150	6	24/96
YT-25995	PH3	150	6	24/72
YT-25996	PH3	200	6	24/72
YT-25997	PH3	250	6	24/72



YATO 	⊖ [mm]	L [mm]	PCS PKG	
YT-25985	6	100	6	24/96
YT-25986	6	150	6	24/96
YT-25987	6	200	6	24/96
YT-25988	6	250	6	24/96
YT-25989	8	150	6	24/72
YT-25990	8	200	6	24/72
YT-25991	8	250	6	24/72
YT-25992	8	300	6	24/72

EN Screwdriver set
PL Komplet wkrętek
DE Schraubendrehersatz
RU Набор отвёрток
CZ Zámečnické šroubováky
HU Lakatos csavarhózó
RO Şurubelnițe de lăcătușerie
FR Set de tournevis
IT Set cacciaviti
ES Juego de destornilladores
CN 敲击螺丝批组套



2 PCS

⊖ ⊕

HRC 52 CrV 6150

⊖ 6.0 mm (L=150 mm);
⊕ PH2 (L=150 mm)

YATO
YT-25998 6/36

EN Screwdriver set
PL Komplet wkrętek
DE Schraubendrehersatz
RU Набор отвёрток
CZ Zámečnické šroubováky
HU Lakatos csavarhózó
RO Şurubelnițe de lăcătușerie
FR Set de tournevis
IT Set cacciaviti
ES Juego de destornilladores
CN 螺丝批组套



6 PCS

⊖ ⊕

⊖ 3.0 mm (L=75 mm), 5.0, 6.0 mm (L=100 mm);
⊕ PH0 (L=75 mm), PH1, PH2 (L=100 mm)

YATO
YT-25965 6/24



8 PCS

⊖ ⊕

⊖ 2.0, 2.4 mm (L=50 mm), 6.0 mm (L=38 mm), 6.0 mm (L=100 mm);
⊕ PH0, PH1 (L=50 mm), PH2 (L=38 mm), PH2 (L=100 mm)

YATO
YT-25980 6/24



8 PCS

⊖ ⊕

⊖ 5.0, 6.0 mm (L=100 mm), 8.0 mm (L=150 mm);
⊕ PH0 (L=75 mm), PH1, PH2 (L=100 mm), PH2 (L=38 mm), PH3 (L=150 mm)

YATO
YT-25966 6/12



12 PCS

⊖ ⊕

⊖ 3.0, 5.0 mm (L=75 mm), 6.0 mm (L=38 mm), 6.0, 8.0 mm (L=150 mm);
⊕ PH0, PH1 (L=75 mm), PH2 (L=38 mm), PH2 (L=100 mm), PH3 (L=150 mm);
⊖ SQ1, SQ2 (L=100 mm)

YATO
YT-25967 6/12

EN Screwdriver set
PL Komplet wkrętek
DE Schraubendrehersatz
RU Набор отвёрток
CZ Zámečnické šroubováky
HU Lakatos csavarhózó
RO Şurubelnițe de lăcătușerie
FR Set de tournevis
IT Set cacciaviti
ES Juego de destornilladores
CN 螺丝批组套



15 PCS

⊖ ⊕

HRC 58 S2

⊖ 1.5, 2.0 mm (L=50 mm), 5.0 mm (L=75 mm), 6.0 mm (L=38 mm), 6.0 mm (L=100 mm), 6.0 mm (L=125 mm);
⊕ PH00, PH0 (L=50 mm), PH1 (L=75 mm), PH2 (L=38 mm), PH2 (L=100 mm);
⊖ T5, T6, T7, T8 (L=50 mm)

YATO
YT-25981 6/24

EN Screwdriver set
PL Komplet wkrętek
DE Schraubendrehersatz
RU Набор отвёрток
CZ Zámečnické šroubováky
HU Lakatos csavarhózó
RO Şurubelnițe de lăcătușerie
FR Set de tournevis
IT Set cacciaviti
ES Juego de destornilladores
CN 螺丝批组套



9 PCS

⊖ ⊕

HRC 58 S2

⊖ 3.0, 5.0 mm (L=75 mm), 6.0 mm (L=100 mm), 6.0, 8.0 mm (L=150 mm);
⊕ PH0, PH1 (L=75 mm), PH2 (L=100 mm), PH2 (L=150 mm)

YATO
YT-25968 6/12

EN 6 in 1 interchangeable screwdriver set
 PL Wkrętarz z końcówkami dwustronnymi
 DE Umsteckschraubendreher
 RU Отвёртка с двухсторонними насадками
 CZ Šroubovák lancer z dvoustrannou koncovkou
 HU Csavarhúzó kétfélgű szárral

RO Şurubelniţă cu dublu capăt
 FR Tournevis embouts réversibles
 IT Cacciavite reversibile
 ES Destornillador con punta de dos caras
 CN 螺丝批

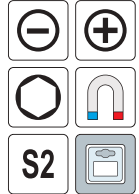

⌀ 5.0 mm x PH1, 6.0 mm x PH2;
 ⌀ 1/4" (6.3 mm) x 5/16" (8 mm)

YATO YT-25971 12/96

EN Screwdriver set
 PL Komplet wkrętarzów
 DE Schraubendrehersatz
 RU Набор отвёрток
 CZ Zámečnické šroubováky
 HU Lakatos csavarhózó
 RO Şurubelniţe de lăcătuşerie
 FR Set de tournevis
 IT Set cacciaviti
 ES Juego de destornilladores
 CN 螺丝批组套



⌀ 2.4, 3.0 mm (L=50 mm), 5.0 mm (L=75 mm), 6.0 mm (L=38 mm), 6.0 mm (L=100 mm), 8.0 mm (L=150 mm);
 ⌀ PH00, PH0 (L=50 mm), PH1 (L=75 mm), PH2 (L=38 mm), PH2 (L=100 mm), PH3 (L=150 mm);
 ⌀ T5, T6, T7, T8, T9, T10 (L=50 mm)

EN Mini pick & hook set
 PL Zestaw haczyków z rękojeścią
 DE Mini Hacken Set
 RU Набор ключков с рукоятками
 CZ Sada háčkových mini páčidel
 HU Mini ár és kampó készlet
 RO Mini-set pt. extras garnituri
 FR Set de crochets
 IT Set ganci con maniglia
 ES Juego de palancas de hierro
 CN 迷你拉拔器组套



YATO YT-0843 12/72

EN Screwdriver set
 PL Komplet wkrętarzów
 DE Schraubendrehersatz
 RU Набор отвёрток
 CZ Zámečnické šroubováky
 HU Lakatos csavarhózó

RO Şurubelniţe de lăcătuşerie
 FR Set de tournevis
 IT Set cacciaviti
 ES Juego de destornilladores
 CN 螺丝批组套

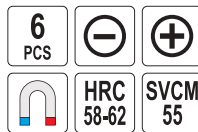

⌀ 5.5, 6.5 mm (L=100 mm), 8.0 mm (L=150 mm);
 ⌀ PH1, PH2 (L=100 mm), PH3 (L=150 mm)

EN Screwdriver set
 PL Komplet wkrętarzów
 DE Schraubendrehersatz
 RU Набор отвёрток
 CZ Zámečnické šroubováky
 HU Lakatos csavarhózó

RO Şurubelniţe de lăcătuşerie
 FR Set de tournevis
 IT Set cacciaviti
 ES Juego de destornilladores
 CN 螺丝批组套

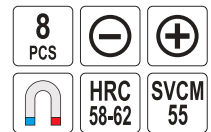

⌀ 4.0, 5.5, 6.5 mm (L=100 mm), 6.5 mm (L=38 mm);
 ⌀ PH0 (L=75 mm), PH1, PH2 (L=100 mm), PH2 (L=38 mm)

YATO YT-2670 4/16

YATO YT-2668 6/24

EN Precision screwdriver
PL Wkręćak precyzyjny
DE Präzisions-Schraubendreher
RU Отвёртка для точных работ

CZ Šroubovák pro jemnou mechaniku
HU Műszerész csavarhúzó
RO Șurubelniță mecanica fina
FR Tournevis de précision

IT Cacciavite di precisione
ES Destornillador de precisión
CN 一字钟表螺丝批

HRC
57-61

S2



YATO	⊖ [mm]	L [mm]	📦
YT-25802	1.4	50	50/400
YT-25803	1.6	50	50/400
YT-25804	1.8	50	50/400
YT-25805	2.0	50	50/400
YT-25806	2.0	75	50/400
YT-25807	2.4	50	50/400
YT-25808	2.4	75	50/400
YT-25809	3.0	50	50/400
YT-25810	3.0	75	50/400
YT-25811	3.0	100	50/400



YATO	⊕	L [mm]	📦
YT-25831	PH000	50	50/400
YT-25832	PH000	75	50/400
YT-25833	PH00	50	50/400
YT-25834	PH00	75	50/400
YT-25835	PH0	50	50/400
YT-25836	PH0	75	50/400
YT-25837	PH0	100	50/400
YT-25838	PH1	50	50/400
YT-25839	PH1	100	50/400
YT-25840	PH1	150	50/400



YATO	⊛	L [mm]	📦
YT-25852	T5	50	50/400
YT-25853	T6	50	50/400
YT-25854	T7	50	50/400
YT-25855	T8	50	50/400
YT-25856	T9	50	50/400
YT-25857	T10	50	50/400

EN Precision screwdriver set
PL Zestaw wkręćaków precyzyjnych
DE Präzisions-Feinmechanikersatz
RU Набор прецизионных отвёрток

CZ Šroubováky sada pro jemnou mechaniku
HU Órás csavarhúzó készlet
RO Set surubelnite
FR Set de tournevis de précision

IT Set cacciavite di precisione
ES Destornilladores precisos
CN 钟表螺丝批组套

HRC
57-61

S2



6
PCS



⊖ 1.4, 2.0, 2.4 mm (L=50 mm);
⊕ PH00, PH0, PH1 (L=50 mm)

6
PCS



⊛ T5, T6, T7, T8, T9, T10 (L=50 mm)



7
PCS



⊖ 2.0, 3.0 mm (L=50 mm);
⊕ PH00, PH0 (L=50 mm);
⊛ T5, T6, T7 (L=50 mm)



YATO	📦
YT-25861	6/36

YATO	📦
YT-25862	6/36

YATO	📦
YT-25863	6/36

EN Mobile phone repair tools set
PL Zestaw do naprawy telefonów komórkowych
DE Mobiltelefon Reparatur Satz
RU Набор инструмента для ремонта мобильных телефонов
CZ Nástroje na opravu mobilních telefonů
HU Mobiltelefon-javítás szerszámkészlet

RO Set surubelnite service telefoane mobile
FR Outils de réparation de téléphone mobil
IT Set di riparazione del telefono cellulare
ES Herramientas de la reparación del teléfono móvil fijadas
CN 精密批维修套装

61
PCS

5/32"
4.0 mm



- ⊖ (L=100 mm);
- ⊖ (L=145 mm);
- ⊖ 1/4" (6.3 mm); (L=46 mm); S2;
- ⊖ (L=60 mm);
- ⊖ (L=85 mm);
- ⊕ 2.5, 3.0, 3.5, 4.0, 4.5, 5.0, 5.5 mm; PH2 (magnetic); S2;
- ⊕ 1.0, 1.5, 2.0, 2.5, 3.0, 3.5, 4.0 mm (L=25 mm); S2;
- ⊕ PH000, PH00, PH0, PH1, PH2 (L=25 mm); S2;
- ⊕ T2, T3, T4, T5, T6, T7 (L=25 mm); S2;
- ⊕ T8, T9, T10, T15, T20 (L=25 mm); S2;
- ⊕ 0.7, 0.9, 1.3, 1.5, 2.0, 2.5, 3.0, 4.0, 4.5, 5.0, 6.0 mm (L=25 mm); S2;
- ⊕ S0, S1, S2 (L=25 mm); S2;
- ⊕ 0.8, 1.2, 1.5 mm (L=25 mm); S2;
- ⊕ 0.6, 2.0, 2.5 mm (L=25 mm); S2;
- ⊕ 2.0, 3.0 mm (L=25 mm); S2;
- ⊕ 2.6, 3.0 mm (L=25 mm); S2;
- ⊕ 0.8 mm (L=25 mm); S2



YATO	📦
YT-25760	25/50

EN 22 in 1 interchangeable screwdriver set
 PL Wkrętarz z końcówkami dwustronnymi
 DE Umsteckschraubendreher
 RU Отвёртка - двухсторонние насадки
 CZ Šroubovák lances z dvoustrannou koncovkou
 HU Csavarhúzó kétvégű szárral

RO Șurubelniță cu dublu capăt
 FR Tournevis + embouts 22 en 1
 IT Set cacciavite con punte reversibile
 ES Destornillador con punta dos caras
 CN 螺丝批组套

12 PCS
 22in1
 22w1

 SVCN



- 4 mm x 5.5 mm (L=175/115 mm)
- 6.5 mm x PH3 (L=175/115 mm)
- PH1 x PH2 (L=175/115 mm)
- PZ1 x PZ2 (L=175/115 mm)
- 3 mm x 3 mm (L=175/115 mm)
- 4 mm x 4 mm (L=175/115 mm)
- 5 mm x 5 mm (L=175/115 mm)
- 6 mm x 6 mm (L=175/115 mm)
- T10 x T15 (L=175/115 mm)
- T20 x T25 (L=175/115 mm)
- T30 x T40 (L=175/115 mm)

YATO
 YT-2797 6/12

EN Ratchet screwdriver with bits
 PL Wkrętarz z grzechotką i bitami
 DE Schraubendreher mit Ratche
 RU Отвёртка с трещеткой
 CZ Šroubovák z fehtačkou
 HU Racsznis csavarbehajtó
 RO Antrenor cu clichet + set biti
 FR Coffret tournevis a cliquet réversible porte-embouts
 IT Set di inserti con chiave a cricchetto
 ES Juego con destornillador y carraca
 CN 螺丝批组套

11 PCS
 1/4" 6.3 mm

 72T
 CrV 6150
 S2



- 1/4" (6.3 mm): 4, 5, 6 mm; S2;
- 1/4" (6.3 mm): PH0, PH1, PH2; S2;
- 1/4" (6.3 mm): S1, S2, S3; S2;
-

YATO
 YT-14390 1/4" (6.3 mm) 25/50

EN Screwdriver set with bits
 PL Zestaw - wkrętarz z końcówkami
 DE Schraubendreher- und Bit-Set
 RU Набор - отвертка с битами
 CZ Sada - šroubovák s koncovkami
 HU Készlet - csavarhúzó bitejekkel

RO Set surubelnita cu biti
 FR Ensemble tournevis avec embout
 IT Set - avvitatrice con punte
 ES Juego de atornillador con puntas
 CN 螺丝批组套



28 PCS

 S2
 CrV

- 6, 7, 8, 10, 12 mm; CrV;
- 1.5 mm x PH000, 2.0 mm x PH00, 2.5 mm x PH0, 3.0 mm x PH1 (L=75 mm); 1.5 mm x PH000, 2.0 mm x PH00, 2.5 mm x PH0 (L=115 mm); S2;
- T6 x T7, T8 x T9 (L=75 mm); T6 x T7, T8 x T9 (L=115 mm); S2;
- 2 x 3 mm (L=75 mm); S2;
- 5 x 6 mm (L=75 mm); 5 x 6 mm (L=115 mm); S2;
- PH1 x PH2, PH2 x PH3 (L=75 mm); PH1 x PH2, PH2 x PH3 (L=115 mm); S2;
- S1 x S2 (L=75 mm); S1 x S3 (L=115 mm); S2;
- 5 x 6 mm (L=75 mm); S2;
- T10 x T15 (L=115 mm); S2

YATO
 YT-27940 6/12

EN Precision screwdriver with bits
 PL Wkrętarz elastyczny z wymiennymi bitami
 DE Schraubendreher- und Bit-Satz
 RU Отвёртка с прецизионными битами
 CZ Šroubovák ráčnový se sadou bitů
 HU Órás csavarhúzó-bit készlet

RO Surubelnita + set biti
 FR Tournevis élastique
 IT Cacciavite flessibile con punte intercambiabili
 ES Juego de pizas terminales para destornillador + mango
 CN 可弯曲批头组套

31 PCS
 215 mm
 1/4" 6.3 mm

 CrV 6150
 S2

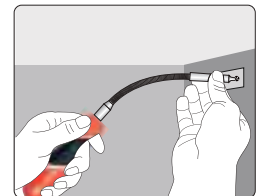
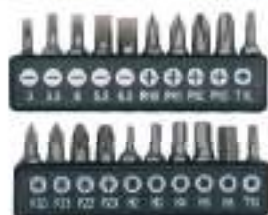

- 1/4" (6.3 mm): 3.0, 3.5, 4.0, 5.5, 6.5 mm (L=25 mm);
- 1/4" (6.3 mm): PH0, PH1, PH2, PH3 (L=25 mm);
- 1/4" (6.3 mm): PZ0, PZ1, PZ2, PZ3 (L=25 mm);
- 1/4" (6.3 mm): T10, T15 (L=25 mm);
- 1/4" (6.3 mm): 2, 3, 4, 5, 6 mm (L=25 mm);
- 1/4" (6.3 mm): 5, 6, 7, 8 x 2, 9, 10, 11, 12, 13 mm

YATO
 YT-25972 6/24

EN Ratchet screwdriver set
PL Wkrętkak z grzechotką, przegubem i bitami
DE Ratschenschraubendreher-Satz mit Einsätzen
RU Набор головок с трещеткой
CZ Ráčnový kloubový šroubovák s příslušenstvím
HU Dugókulcs és bit készlet csuklós

RO Set surubelnita
FR Clé mixte à cliquet + embouts
IT Set do chiavi a cricchetto e inserti
ES Juego con destornillador y carraca
CN 棘轮螺丝批组套



42 PCS 1/4" 6.3 mm

⊖ ⊕

⊕ ⊖

⊕ ⊖

AISI S2

CrV 50BV30

- 1/4" (6.3 mm): 5, 6, 7, 8, 9, 10, 11, 12, 13 mm;
- 1/4" (6.3 mm) (L=100 mm);
- 1/4" (6.3 mm); CrV 50BV30;
- ⊕ 3, 4, 5, 6, 7 mm;
- ⊕ PH1 x2, PH2 x2, PH3 x2;
- ⊕ PZ1 x2, PZ2 x2, PZ3 x2;
- ⊕ T10, T15, T20, T25, T27, T30, T40;
- 2, 2.5, 3, 4, 5, 6 mm

YATO

YT-2806 12

EN Impact screwdriver
PL Wkrętkak udarowy
DE Schlagschrauber
RU Отвёртка ударная
CZ Narazový šroubovák kovový
HU Kézi ütvecsavarhúzó

RO Şurubelniţă metalică cu percutor
FR Tournevis à choc
IT Cacciavite percussione
ES Destornillador de percusión
CN 冲击螺丝批组套



7 PCS 1/2" 12.7 mm 5/16" 8 mm

⊖ ⊕

⊕ ⊖

CrV 6150

- 5/16" (7.9 mm) x 1/2" (12.7 mm);
- ⊕ 7, 8 mm (L=35 mm); 8 mm (L=75 mm);
- ⊕ PH2, PH3 (L=35 mm); PH2 (L=75 mm)

EN Impact screwdriver
PL Wkrętkak udarowy
DE Schlagschrauber
RU Отвёртка ударная
CZ Narazový šroubovák kovový
HU Kézi ütvecsavarhúzó

7 PCS 175 mm 1/2" 12.7 mm 5/16" 8 mm

⊖ ⊕

CrV 6150



- 5/16" (7.9 mm) x 1/2" (12.7 mm);
- ⊕ 7, 8 mm (L=35 mm); 8 mm (L=75 mm);
- ⊕ PH2, PH3 (L=35 mm); PH3 (L=75 mm)

YATO

YT-28003 8/16

EN Impact screwdriver
PL Wkrętkak udarowy
DE Schlagschrauber
RU Отвёртка ударная
CZ Narazový šroubovák kovový
HU Kézi ütvecsavarhúzó

RO Şurubelniţă metalică cu percutor
FR Tournevis à choc
IT Cacciavite percussione
ES Destornillador de percusión
CN 冲击螺丝批组套

15 PCS 160 mm 1/2" 12.7 mm 5/16" 8 mm

⊖ ⊕

⊕ ⊖

CrV 6150 S2

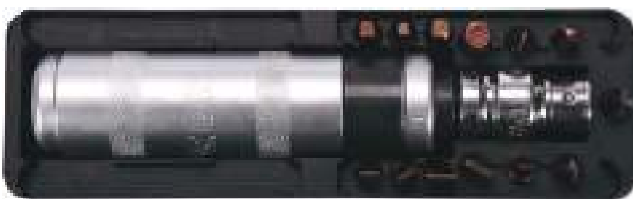

- 5/16" (7.9 mm) x 1/2" (12.7 mm);
- ⊕ 4, 5, 6, 8, 9 mm (L=35 mm); S2;
- ⊕ PH1, PH2, PH3, PH4 (L=35 mm); S2;
- 4, 5, 6, 8 (L=35 mm); S2

YATO

YT-28015 16

EN Impact screwdriver
PL Wkrętkak udarowy
DE Schlagschrauber
RU Отвёртка ударная
CZ Narazový šroubovák kovový
HU Kézi ütvecsavarhúzó

RO Şurubelniţă metalică cu percutor
FR Tournevis à choc
IT Cacciavite percussione
ES Destornillador de percusión
CN 冲击螺丝批

7 PCS 1/2" 12.7 mm 5/16" 8 mm

⊖ ⊕

⊕ ⊖

CrV 6150



- 5/16" (7.9 mm) x 1/2" (12.7 mm);
- ⊕ 8 mm (L=35 mm); 8 mm (L=75 mm)
- ⊕ PH3 (L=35 mm); PH1, PH2, PH3 (L=75 mm)

YATO

YT-2802 20

EN Impact screwdriver
PL Wkrętkak udarowy
DE Schlagschrauber
RU Отвёртка ударная
CZ Narazový šroubovák kovový
HU Kézi ütvecsavarhúzó
RO Şurubelniţă metalică cu percutor
FR Tournevis à choc
IT Cacciavite percussione
ES Destornillador de percusión
CN 冲击螺丝批组套

32 PCS 168 mm 1/2" 12.7 mm

⊖ ⊕

⊕ ⊖

CrV 6150 S2



- 1/2" (12.7 mm); 10, 13, 15 mm; CrV 6150;
- ⊕ 0.8x5.5, 1.2x6.5, 1.2x8, 1.6x10, 2x12, 2.5x14 mm (L=35 mm); S2;
- ⊕ PH1, PH2, PH3, PH4 (L=35 mm); PH2, PH3 (L=75 mm); S2;
- ⊕ T25, T27, T30, T40, T45, T50, T55 (L=35 mm); S2;
- 4, 5, 6, 7, 8, 10, 12 mm (L=35 mm); S2;
- ⊕ #3, #4

YATO

YT-28000 10

EN Screwdriver bit set
 PL Zestaw bitów do wkrętek udarowych
 DE Schraubendreherbitsatz
 RU Набор бит крестовых
 CZ Sada bitů
 HU Bitkészlet
 RO Truse bit
 FR Embouts à choc
 IT Set punte cacciavite
 ES Puntas de destornilladora
 CN 冲击批头组套

CrV
6150



YATO	+	-	L [mm]	⊕ [mm]	pcs / szt.	📦
YT-2810	PH2	-	36	5/16" (7.9 mm)	5	10/100
YT-2811	PH3	-	36	5/16" (7.9 mm)	5	10/100
YT-2812	PH2, PH3	8, 10	36	5/16" (7.9 mm)	4	10/100

EN Screwdriver bit
 PL Końcówka śrubokrętowa
 DE Schraubendreherbit
 RU Вставка-бита

CZ Šroubovací bit
 HU Csavarbit
 RO Capăt pt. șurubelniță
 FR Embout de tournevis

IT Punta per cacciavite
 ES Punta de destornillador
 CN 旋具头



21.8
Nm
(max.)

HRC
58-62

SAISI
S2

COLD FORGED
KÜTE
NA ZIMNO



YATO	+	L [mm]	⊕ [mm]	📦
YT-0485	PH2	100	1/4" (6.3 mm)	25/100
YT-0486	PH2	150	1/4" (6.3 mm)	25/100
YT-0487	PH2	200	1/4" (6.3 mm)	25/100

EN Screwdriver bit
 PL Końcówka śrubokrętowa
 DE Schraubendreherbit
 RU Бит крестовая

CZ Šroubovavková koncovka
 HU Csavarhúzóvég
 RO Capăt pt. șurubelniță
 FR Douille tournevis

IT Punta del cacciavite
 ES Punta de destornillador
 CN 旋具头组套

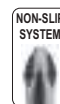

HRC
58-61

SAISI
S2

COLD FORGED
KÜTE
NA ZIMNO



YATO	+	L [mm]	⊕ [mm]	[Nm]	pcs / szt.	📦
YT-04702	PZ1	25	1/4" (6.3 mm)	6.4	10	25/200
YT-04712	PZ2	25	1/4" (6.3 mm)	19.6	10	25/200
YT-04722	PZ3	25	1/4" (6.3 mm)	45.1	10	25/200



YATO	+	L [mm]	⊕ [mm]	[Nm]	pcs / szt.	📦
YT-04742	PH1	25	1/4" (6.3 mm)	6.4	10	25/200
YT-04752	PH2	25	1/4" (6.3 mm)	19.6	10	25/200
YT-04762	PH3	25	1/4" (6.3 mm)	45.1	10	25/200

EN Screwdriver bit
 PL Końcówka śrubokrętowa
 DE Schraubendreherbit

RU Бит крестовая

CZ Šroubovavková koncovka
 HU Csavarhúzóvég

RO Capăt pt. șurubelniță
 FR Douille tournevis
 IT Punta del cacciavite

ES Punta de destornillador
 CN 旋具头组套

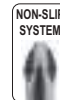

HRC
58-61

SAISI
S2

COLD FORGED
KÜTE
NA ZIMNO



YATO	+	L [mm]	⊕ [mm]	[Nm]	pcs / szt.	📦
YT-04772	PH1	50	1/4" (6.3 mm)	6.4	10	25/100
YT-04782	PH2	50	1/4" (6.3 mm)	19.6	10	25/100
YT-04792	PH3	50	1/4" (6.3 mm)	45.1	10	25/100



YATO	+	L [mm]	⊕ [mm]	[Nm]	pcs / szt.	📦
YT-04812	PH2xPH2	65	1/4" (6.3 mm)	19.6 / 19.6	10	25/100

EN Screwdriver bit set
PL Zestaw końcówek śrubokrętowych
DE Schraubendreherbitsatz
RU Набор битов
CZ Sada šroubovacích bitů
HU Csavarbit készlet
RO Trusă biți
FR Jeu d'embouts de tournevis
IT Set punte per cacciavite
ES Juego de puntas para atornillar
CN 旋具头组套

10 PCS HRC 58-61 AISI S2 COLD FORGED KUTE NA ZIMNO



□ 5, 6 mm;
⊕ PH1, PH1, PH2, PH2;
⊕ PZ1, PZ1, PZ2, PZ2

YATO	L [mm]	□	pcs / szt.	📦
YT-04822	25	1/4" (6.3 mm)	10	25/200

EN Screwdriver bit
PL Końcówka śrubokrętowa
DE Schraubendreherbit
RU Бит крестовая
CZ Šroubovavková koncovka
HU Csavarhúzóvég
RO Capăt pt. șurubelniță
FR Douille tournevis
IT Punta del cacciavite
ES Punta de destornilladora
CN 十字旋具头

EN Screwdriver bit set
PL Zestaw końcówek śrubokrętowych
DE Schraubendreherbitsatz
RU Набор битов
CZ Sada šroubovacích bitů
HU Csavarbit készlet
RO Trusă biți
FR Jeu d'embouts de tournevis
IT Set punte per cacciavite
ES Juego de puntas para atornillar
CN 旋具头组套

10 PCS HRC 58-61 AISI S2 COLD FORGED KUTE NA ZIMNO



□ 5, 6 mm;
⊕ PH1, PH1, PH2, PH2;
⊕ PZ1, PZ1, PZ2, PZ2

YATO	L [mm]	□	pcs / szt.	📦
YT-04832	50	1/4" (6.3 mm)	10	25/100



YATO	⊕	L [mm]	□	[Nm]	pcs / szt.	📦
YT-78134	PZ1	25	1/4" (6.3 mm)	6.4	10	20/100
YT-78135	PZ2	25	1/4" (6.3 mm)	19.6	10	20/100
YT-78136	PZ3	25	1/4" (6.3 mm)	45.1	10	20/100



YATO	⊕	L [mm]	□	[Nm]	pcs / szt.	📦
YT-78130	PH0	25	1/4" (6.3 mm)	2.1	10	20/100
YT-78131	PH1	25	1/4" (6.3 mm)	7.8	10	20/100
YT-78132	PH2	25	1/4" (6.3 mm)	19.6	10	20/100
YT-78133	PH3	25	1/4" (6.3 mm)	45.6	10	20/100



YATO	⊕	L [mm]	□	[Nm]	pcs / szt.	📦
YT-78141	T10	25	1/4" (6.3 mm)	5.9	10	20/100
YT-78142	T15	25	1/4" (6.3 mm)	8.4	10	20/100
YT-78143	T20	25	1/4" (6.3 mm)	14.7	10	20/100
YT-78144	T25	25	1/4" (6.3 mm)	21.6	10	20/100
YT-78145	T27	25	1/4" (6.3 mm)	29.4	10	20/100
YT-78146	T30	25	1/4" (6.3 mm)	45.1	10	20/100
YT-78147	T40	25	1/4" (6.3 mm)	76.5	10	20/100

EN Screwdriver bit
PL Końcówka śrubokrętowa
DE Schraubendreherbit
RU Бит крестовая
CZ Šroubovavková koncovka
HU Csavarhúzóvég
RO Capăt pt. șurubelniță
FR Douille tournevis
IT Punta del cacciavite
ES Punta de destornilladora
CN 旋具头组套

HRC 58-61 AISI S2



YATO	⊕	L [mm]	□	[Nm]	pcs / szt.	📦
YT-78151	PH1	50	1/4" (6.3 mm)	6.4	10	20/100
YT-78152	PH2	50	1/4" (6.3 mm)	19.6	10	20/100
YT-78153	PH3	50	1/4" (6.3 mm)	45.1	10	20/100



YATO	⊕	L [mm]	□	[Nm]	pcs / szt.	📦
YT-78154	PZ1	50	1/4" (6.3 mm)	6.4	10	20/100
YT-78155	PZ2	50	1/4" (6.3 mm)	19.6	10	20/100
YT-78156	PZ3	50	1/4" (6.3 mm)	45.1	10	20/100

EN Screwdriver bit set
 PL Zestaw końcówek śrubokrętowych
 DE Schraubendreherbitsatz
 RU Набор битов

CZ Sada bitů
 HU Bitkészlet
 RO Truse bit
 FR Embouts de vissage

IT Set punte cacciavite
 ES Puntas de destornilladora
 CN 旋具头组套



10 PCS

21.8 Nm (max.)

HRC 58-62

AISI S2

COLD FORGED KUTE NA ZIMNO



YATO	+	L [mm]	⊘	📦
YT-0470	PZ1	25	1/4" (6.3 mm)	25/200
YT-0471	PZ2	25	1/4" (6.3 mm)	25/200
YT-0472	PZ3	25	1/4" (6.3 mm)	25/200



YATO	+	L [mm]	⊘	📦
YT-0477	PH1	50	1/4" (6.3 mm)	25/100
YT-0478	PH2	50	1/4" (6.3 mm)	25/100
YT-0480	PH2	75	1/4" (6.3 mm)	25/100



YATO	+	L [mm]	⊘	📦
YT-0474	PH1	25	1/4" (6.3 mm)	25/200
YT-0475	PH2	25	1/4" (6.3 mm)	25/200
YT-0476	PH3	25	1/4" (6.3 mm)	25/200



YATO	+	L [mm]	⊘	📦
YT-0481	PH2xPH2	65	1/4" (6.3 mm)	25/100

EN Screwdriver bit set
 PL Zestaw końcówek śrubokrętowych
 DE Schraubendreherbitsatz
 RU Набор битов

CZ Sada bitů
 HU Bitkészlet
 RO Truse bit
 FR Embouts de vissage

IT Set punte cacciavite
 ES Puntas de destornilladora
 CN 旋具头组套



10 PCS

21.8 Nm (max.)

HRC 58-62

AISI S2

COLD FORGED KUTE NA ZIMNO



⊘ 1/4" (6.3 mm); 5, 6 mm (L=25 mm); AISI S2;
 ⊕ 1/4" (6.3 mm); PH1 x2, PH2 x2 (L=25 mm); AISI S2;
 ⊗ 1/4" (6.3 mm); PZ1 x2, PZ2 x2 (L=25 mm); AISI S2

YATO	L [mm]	⊘	📦
YT-0482	25	1/4" (6.3 mm)	25/200



⊘ 1/4" (6.3 mm); 5, 6 mm (L=50 mm); AISI S2;
 ⊕ 1/4" (6.3 mm); PH1 x2, PH2 x2 (L=50 mm); AISI S2;
 ⊗ 1/4" (6.3 mm); PZ1 x2, PZ2 x2 (L=50 mm); AISI S2

YATO	L [mm]	⊘	📦
YT-0483	25	1/4" (6.3 mm)	25/100

EN Screwdriver bit
 PL Końcówka śrubokrętowa
 DE Schraubendreherbit

RU Бит крестовая
 CZ Šroubovavková koncovka
 HU Csavarhúzóvég

RO Capăt pt. șurubelniță
 FR Douille tournevis
 IT Punta del cacciavite

ES Punta de destornilladora
 CN 旋具头组套

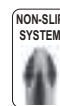

HRC 58-62

AISI S2

COLD FORGED KUTE NA ZIMNO



YATO	+	L [mm]	⊘	pcs / szt.	📦
YT-7807	PH1	25	1/4" (6.3 mm)	50	20/40
YT-7808	PH2	25	1/4" (6.3 mm)	50	20/40
YT-7809	PH3	25	1/4" (6.3 mm)	50	20/40



YATO	+	L [mm]	⊘	pcs / szt.	📦
YT-7810	PZ1	25	1/4" (6.3 mm)	50	20/40
YT-7811	PZ2	25	1/4" (6.3 mm)	50	20/40
YT-7812	PZ3	25	1/4" (6.3 mm)	50	20/40

EN Screwdriver bit
 PL Końcówka śrubokrętowa
 DE Schraubendreherbit
 RU Вставка-бита
 CZ Šroubovací bit
 HU Csavarbit
 RO Capăt pt. șurubelniță
 FR Embout de tournevis
 IT Punta per cacciavite
 ES Punta de destornillador
 CN 旋具头



• With limiter
 • Z ogranicznikiem

YATO	L [mm]	⊘	pcs / szt.	📦
YT-7980	25	1/4" (6.3 mm)	20	20/40

EN Screwdriver bit
PL Końcówka śrubokrętowa
DE Schraubendreherbit
RU Бит крестовая
CZ Šroubovaková koncovka
HU Csavarhűzővég
RO Capăt pt. surubelniță
FR Douille tournevis
IT Punta del cacciavite
ES Punta de destornilladora
CN 旋具头组套

2 PCS
1/4"
6.3 mm
S2

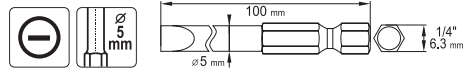

YATO	⊖ [mm]	L [mm]	⊘	📦
YT-0484	4, 5	100	1/4" (6.3 mm)	25/100

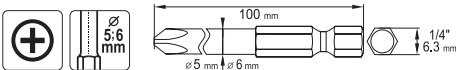

YATO	⊕	L [mm]	⊘	📦
YT-0488	PH1, PH2	100	1/4" (6.3 mm)	25/100

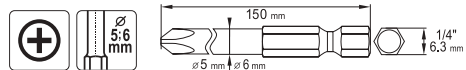

YATO	⊕	L [mm]	⊘	📦
YT-0489	PH1, PH2	150	1/4" (6.3 mm)	25/100

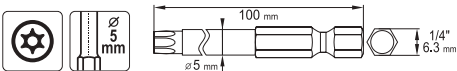

YATO	⊗	L [mm]	⊘	📦
YT-0490	T10, T25	100	1/4" (6.3 mm)	25/100

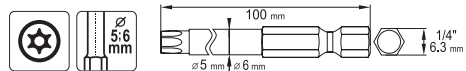

YATO	⊗	L [mm]	⊘	📦
YT-0491	T15, T27	100	1/4" (6.3 mm)	25/100
YT-0492	T20, T30	100	1/4" (6.3 mm)	25/100

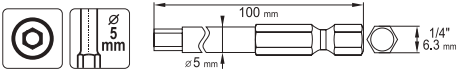

YATO	⊙ [mm]	L [mm]	⊘	📦
YT-0494	3, 5	100	1/4" (6.3 mm)	25/100

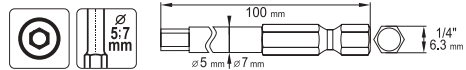

YATO	⊙ [mm]	L [mm]	⊘	📦
YT-0495	4, 6	100	1/4" (6.3 mm)	25/100

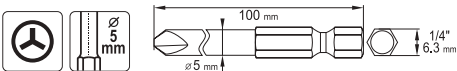

YATO	⊚ [mm]	L [mm]	⊘	📦
YT-0493	0, 1	100	1/4" (6.3 mm)	25/100
YT-0496	1, 3	100	1/4" (6.3 mm)	25/100

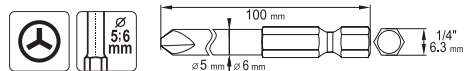

YATO	⊚ [mm]	L [mm]	⊘	📦
YT-0497	2, 4	100	1/4" (6.3 mm)	25/100

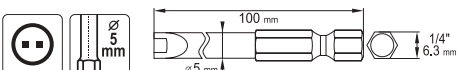

YATO	⊛ [mm]	L [mm]	⊘	📦
YT-0498	4, 8	100	1/4" (6.3 mm)	25/100

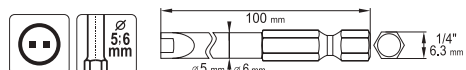

YATO	⊛ [mm]	L [mm]	⊘	📦
YT-0499	6, 10	100	1/4" (6.3 mm)	25/100

EN Screwdriver bit set
 PL Zestaw końcówek śrubokrętowych
 DE Schraubendreherbitsatz
 RU Набор битов
 CZ Sada šroubovacích bitů
 HU Csavarbit készlet

RO Trusă biți
 FR Jeu d'embouts de tournevis
 IT Set punte per cacciavite
 ES Juego de puntas para atornillar
 CN 旋具头组套

40
PCS



21.8
Nm
(max.)

HRC
58-62

AISI
S2



3/8" (9.5 mm): T20, T25, T30, T40, T45, T50, T55 (L=30 mm);
 T20, T25, T30, T40, T45, T50, T55 (L=75 mm); AISI S2;
 3/8" (9.5 mm): 4, 5, 6, 7, 8, 10, 12 mm (L=30 mm); 4, 5, 6, 7, 8, 10, 12 mm (L=75 mm); AISI S2;
 3/8" (9.5 mm): M5, M6, M8, M10, M12 (L=30 mm); M5, M6, M8, M10, M12 (L=75 mm); AISI S2;
 1/2" (12.7 mm) x 3/8" (9.5 mm), 3/8" (9.5 mm) x 3/8" (9.5 mm); CrV 6150

YATO 	
YT-0400	10

EN Screwdriver bit set
 PL Zestaw końcówek śrubokrętowych
 DE Schraubendreherbitsatz
 RU Набор битов
 CZ Sada šroubovacích bitů
 HU Csavarbit készlet

RO Trusă biți
 FR Jeu d'embouts de tournevis
 IT Set punte per cacciavite
 ES Juego de puntas para atornillar
 CN 旋具头组套

15
PCS



21.8
Nm
(max.)

HRC
58-62

AISI
S2



3/8" (9.5 mm): T20, T25, T30, T40, T45, T50, T55 (L=30 mm);
 T20, T25, T30, T40, T45, T50, T55 (L=75 mm); AISI S2;
 1/2" (12.7 mm) x 3/8" (9.5 mm); CrV 6150

YATO 	
YT-0411	20

EN Screwdriver bit set
 PL Zestaw końcówek śrubokrętowych
 DE Schraubendreherbitsatz
 RU Набор битов
 CZ Sada šroubovacích bitů
 HU Csavarbit készlet

RO Trusă biți
 FR Jeu d'embouts de tournevis
 IT Set punte per cacciavite
 ES Juego de puntas para atornillar
 CN 旋具头组套

15
PCS



21.8
Nm
(max.)

HRC
58-62

AISI
S2



3/8" (9.5 mm): 4, 5, 6, 7, 8, 10, 12 (L=30 mm); 4, 5, 6, 7, 8, 10, 12 (L=75 mm); AISI S2;
 1/2" (12.7 mm) x 3/8" (9.5 mm); CrV 6150

YATO 	
YT-0413	20

EN Screwdriver bit set
 PL Zestaw końcówek śrubokrętowych
 DE Schraubendreherbitsatz
 RU Набор битов
 CZ Sada šroubovacích bitů
 HU Csavarbit készlet

RO Trusă biți
 FR Jeu d'embouts de tournevis
 IT Set punte per cacciavite
 ES Juego de puntas para atornillar
 CN 旋具头组套

7
PCS



21.8
Nm
(max.)

HRC
58-62

AISI
S2



3/8" (9.5 mm): T25, T30, T40, T45, T50, T55 (L=30 mm); AISI S2;
 1/2" (12.7 mm) x 3/8" (9.5 mm); CrV 6150

YATO 	
YT-0410	24/72

EN Screwdriver bit set
 PL Zestaw końcówek śrubokrętowych
 DE Schraubendreherbitsatz
 RU Набор битов
 CZ Sada šroubovacích bitů
 HU Csavarbit készlet

RO Trusă biți
 FR Jeu d'embouts de tournevis
 IT Set punte per cacciavite
 ES Juego de puntas para atornillar
 CN 旋具头组套

7
PCS



21.8
Nm
(max.)

HRC
58-62

AISI
S2



3/8" (9.5 mm): 4, 5, 6, 8, 10, 12 mm (L=30 mm); AISI S2;
 1/2" (12.7 mm) x 3/8" (9.5 mm); CrV 6150

YATO 	
YT-0412	24/72

EN Screwdriver bit set
 PL Zestaw końcówek śrubokrętowych
 DE Schraubendreherbitsatz
 RU Набор битов
 CZ Sada šroubovacích bitů
 HU Csavarbit készlet

RO Trusă biți
 FR Jeu d'embouts de tournevis
 IT Set punte per cacciavite
 ES Juego de puntas para atornillar
 CN 旋具头组套

6
PCS



21.8
Nm
(max.)

HRC
58-62

AISI
S2



3/8" (9.5 mm): M5, M6, M8, M10, M12 (L=30 mm); AISI S2;
 1/2" (12.7 mm) x 3/8" (9.5 mm); CrV 6150

YATO 	
YT-0414	24/72

EN Screwdriver bit set
PL Zestaw końcówek śrubokrętowych
DE Schraubendreherbitsatz
RU Набор битов
CZ Sada šroubovacích bitů
HU Csavarbit készlet

RO Trusă biți
FR Jeu d'embouts de tournevis
IT Set punte per cacciavite
ES Juego de puntas para atornillar
CN 旋具头组套

11
PCS



21.8
Nm
(max.)

HRC
58-62

AISI
S2



3/8" (9.5 mm): M5, M6, M8, M10, M12 (L=30 mm); M5, M6, M8, M10, M12 (L=75 mm); AISI S2;
1/2" (12.7 mm) x 3/8" (9.5 mm); CrV 6150

YATO

YT-0415

20

EN Screwdriver bit set
PL Zestaw końcówek śrubokrętowych
DE Schraubendreherbitsatz
RU Набор битов
CZ Sada šroubovacích bitů
HU Csavarbit készlet

RO Trusă biți
FR Jeu d'embouts de tournevis
IT Set punte per cacciavite
ES Juego de puntas para atornillar
CN 旋具头组套

15
PCS



21.8
Nm
(max.)

HRC
58-62

AISI
S2



3/8" (9.5 mm): T20, T25, T30, T40, T45, T50, T55 (L=30 mm);
T20, T25, T30, T40, T45, T50, T55 (L=75 mm); AISI S2;
1/2" (12.7 mm) x 3/8" (9.5 mm); CrV 6150

YATO

YT-0417

20

EN Screwdriver bit set
PL Zestaw końcówek śrubokrętowych
DE Schraubendreherbitsatz
RU Набор битов
CZ Sada šroubovacích bitů
HU Csavarbit készlet

RO Trusă biți
FR Jeu d'embouts de tournevis
IT Set punte per cacciavite
ES Juego de puntas para atornillar
CN 旋具头组套

15
PCS



21.8
Nm
(max.)

HRC
58-62

AISI
S2



3/8" (9.5 mm): M6, M7, M8, M9, M10, M12, M14 (L=30 mm);
M6, M7, M8, M9, M10, M12, M14 (L=75 mm); AISI S2;
1/2" (12.7 mm) x 3/8" (9.5 mm); CrV 6150

YATO

YT-0419

20

EN Screwdriver bit set
PL Zestaw końcówek śrubokrętowych
DE Schraubendreherbitsatz
RU Набор битов
CZ Sada šroubovacích bitů
HU Csavarbit készlet

RO Trusă biți
FR Jeu d'embouts de tournevis
IT Set punte per cacciavite
ES Juego de puntas para atornillar
CN 旋具头组套

7
PCS



21.8
Nm
(max.)

HRC
58-62

AISI
S2



3/8" (9.5 mm): T25, T30, T40, T45, T50, T55 (L=30 mm); AISI S2;
1/2" (12.7 mm) x 3/8" (9.5 mm); CrV 6150

YATO

YT-0416

24/72

EN Screwdriver bit set
PL Zestaw końcówek śrubokrętowych
DE Schraubendreherbitsatz
RU Набор битов
CZ Sada šroubovacích bitů
HU Csavarbit készlet

RO Trusă biți
FR Jeu d'embouts de tournevis
IT Set punte per cacciavite
ES Juego de puntas para atornillar
CN 旋具头组套

8
PCS



21.8
Nm
(max.)

HRC
58-62

AISI
S2



3/8" (9.5 mm): M5, M6, M7, M8, M10, M12, M14 (L=30 mm); AISI S2;
1/2" (12.7 mm) x 3/8" (9.5 mm); CrV 6150

YATO

YT-0418

24/72

EN Screwdriver bit set
PL Zestaw końcówek śrubokrętowych
DE Schraubendreherbitsatz
RU Набор битов
CZ Sada šroubovacích bitů
HU Csavarbit készlet

RO Trusă biți
FR Jeu d'embouts de tournevis
IT Set punte per cacciavite
ES Juego de puntas para atornillar
CN 旋具头组套

42
PCS



21.8
Nm
(max.)

HRC
58-62

AISI
S2



3/8" (9.5 mm): T20, T25, T30, T40, T45, T50, T55, T60, T70 (L=30 mm);
T20, T25, T30, T40, T45, T50, T55, T60, T70 (L=75 mm); AISI S2;
3/8" (9.5 mm): M4, M5, M6, M7, M8, M9, M10, M11, M12, M13, M14 (L=30 mm);
M4, M5, M6, M7, M8, M9, M10, M11, M12, M13, M14 (L=75 mm); AISI S2;
1/2" (12.7 mm) x 3/8" (9.5 mm), 3/8" (9.5 mm) x 3/8" (9.5 mm); CrV 6150

YATO

YT-0420

10

5

EN Screwdriver bit set
 PL Zestaw końcówek śrubokrętowych
 DE Schraubendreherbitsatz
 RU Набор битов

CZ Sada šroubovacích bitů
 HU Csavarbit készlet
 RO Trusă biți
 FR Jeu d'embouts de tournevis

IT Set punte per cacciavite
 ES Juego de puntas para atornillar
 CN 旋具头组套



23 PCS 1/4" 6.3mm

S2

- PH 1/4" (6.3 mm): PH0, PH2 x2, PH3 (L=25 mm); PH2 (L=50 mm); S2;
- PZ 1/4" (6.3 mm): PZ0, PZ2 x2, PZ3 (L=25 mm); PZ2 (L=50 mm); S2;
- T 1/4" (6.3 mm): T20 x2, T25 x2, T30 x2, T40 (L=25 mm); T20, T30 (L=50 mm); S2;
- 4, 5, 6 mm (L=25 mm); S2;
- 1/4" (6.3 mm); (L=60 mm); CrV

YATO YT-04621 20

EN Screwdriver bit set
 PL Zestaw końcówek śrubokrętowych
 DE Schraubendreherbitsatz
 RU Набор битов

CZ Sada šroubovacích bitů
 HU Csavarbit készlet
 RO Trusă biți
 FR Jeu d'embouts de tournevis

IT Set punte per cacciavite
 ES Juego de puntas para atornillar
 CN 旋具头组套



32 PCS 1/4" 6.3mm

S2

- 1/4" (6.3 mm): 3, 4, 5, 6 mm (L=25 mm); S2;
- PH 1/4" (6.3 mm): PH1, PH2 x2, PH3 (L=25 mm); S2;
- PZ 1/4" (6.3 mm): PZ1, PZ2 x2, PZ3 (L=25 mm); S2;
- T 1/4" (6.3 mm): T10, T15, T20, T25, T27, T30, T40 (L=25 mm); S2;
- T10, T15, T20, T25, T27, T30, T40 (L=25 mm); S2;
- 3, 4, 5, 6 mm (L=25 mm); S2;
- 1/4" (6.3 mm); (L=70 mm); CrV;
- 1/4" (6.3 mm); (L=25 mm); S2

YATO YT-04622 20

EN Screwdriver bit set
 PL Zestaw końcówek śrubokrętowych
 DE Schraubendreherbitsatz
 RU Набор битов

CZ Sada šroubovacích bitů
 HU Csavarbit készlet
 RO Trusă biți
 FR Jeu d'embouts de tournevis

IT Set punte per cacciavite
 ES Juego de puntas para atornillar
 CN 旋具头组套



34 PCS 1/4" 6.3mm

S2

- 1/4" (6.3 mm): 5, 6, 7, 8, 9, 10, 11, 12 mm (L=25 mm);
- 1/4" (6.3 mm); (L=75 mm);
- 1/4" (6.3 mm): 3, 4, 5.5 x2, 6.5 x2 mm (L=25 mm); S2;
- PH 1/4" (6.3 mm): PH1 x2, PH2 x2, PH3 x2 (L=25 mm); S2;
- PZ 1/4" (6.3 mm): PZ1 x2, PZ2 x2, PZ3 x2 (L=25 mm); S2;
- T 1/4" (6.3 mm): T10, T15, T20, T25, T27, T30 (L=25 mm); S2;
- 1/4" (6.3 mm); (L=60 mm); CrV

YATO YT-04623 20

EN Screwdriver bit set
 PL Zestaw końcówek śrubokrętowych
 DE Schraubendreherbitsatz
 RU Набор битов
 CZ Sada šroubovacích bitů
 HU Csavarbit készlet

RO Trusă biți
 FR Jeu d'embouts de tournevis
 IT Set punte per cacciavite
 ES Juego de puntas para atornillar
 CN 旋具头组套

40 PCS 1/4" 6.3mm

S2

- 1/4" (6.3 mm): 3, 4, 5, 6, 7 mm (L=25 mm); S2;
- PH 1/4" (6.3 mm): PH0, PH1, PH2, PH3 (L=25 mm); PH1, PH2 (L=50 mm); S2;
- PZ 1/4" (6.3 mm): PZ0, PZ1, PZ2, PZ3 (L=25 mm); PZ1, PZ2 (L=50 mm); S2;
- T 1/4" (6.3 mm): T8, T10, T15, T20, T25, T27, T30, T40 (L=25 mm); S2;
- 2, 2.5, 3, 4, 5, 5.5, 6 x2 mm (L=25 mm); S2;
- 1/4" (6.3 mm): S1, S2, S3 (L=25 mm); S2;
- 1/4" (6.3 mm): 5 mm x PH1, 6 mm x PH2, 6 mm x PH3 (L=65 mm); S2;
- 1/4" (6.3 mm): PH2 x PH2, PH2 x PH3 (L=65 mm); S2;
- 1/4" (6.3 mm): PZ1 x PZ1, PZ2 x PZ2, PZ3 x PZ3 (L=65 mm); S2;
- 1/4" (6.3 mm); (L=60 mm); S2

YATO YT-04620 20

EN Screwdriver bit set
PL Zestaw końcówek śrubokrętowych
DE Schraubendreherbitsatz
RU Набор бит

CZ Sada šroubovacích bitů
HU Csavarbit készlet
RO Trusă biți
FR Jeu d'embouts de tournevis

IT Set punte per cacciavite
ES Juego de puntas para atomillar
CN 旋具头组套

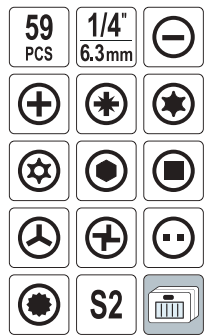

- 1/4" (6.3 mm): 2, 4, 6.5 mm (L=25 mm); S2;
- ⊕ 1/4" (6.3 mm): PH0, PH1 x2, PH2 x2, PH3 (L=25 mm); S2;
- ⊕ 1/4" (6.3 mm): PZ1 x2, PZ2 x2, PZ3 (L=25 mm); S2;
- ⊕ 1/4" (6.3 mm): T10, T15, T20, T25, T30, T40 (L=25 mm); S2;
- ⊕ 1/4" (6.3 mm): T8, T9, T10, T15, T20, T25, T27, T30, T40 (L=25 mm); S2;
- 1/4" (6.3 mm): 2, 2.5, 3, 4, 5, 6, 8 mm (L=25 mm); S2;
- 1/4" (6.3 mm): 0, 1, 2, 3 mm (L=25 mm); S2;
- ⊕ 1/4" (6.3 mm): 1, 2, 3, 4 mm (L=25 mm); S2;
- ⊕ 1/4" (6.3 mm): 6, 8, 10 mm (L=25 mm); S2;
- ⊕ 1/4" (6.3 mm): 4, 6, 8, 10 mm (L=25 mm); S2;
- 1/4" (6.3 mm): M5, M6, M8 (L=25 mm); S2;
- ⊕ 1/4" (6.3 mm): C1, C2, C3 (L=25 mm); S2;
- 1/4" (6.3 mm): (L=70 mm); CrV;
- ⊕ 1/4" (6.3 mm); CrV

YATO	
YT-04624	20

EN Nut setter
PL Nasadka magnetyczna do wkrętarci
DE Magnet-Steckschlüssel mit Adapter
RU Магнитная головка для винтовёрта
CZ Nástrčný kľúč magnetický do vrtačky
HU Csavarbehajtó
RO Cheie tubulara cu prindere tip mandrina
FR Douille tournevis magnétique
IT Cappuccio magnetico la vite
ES Boquilla magnética de destornilladora
CN 磁性套筒

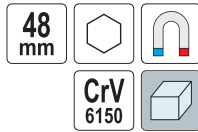

YATO	o [mm]	
YT-1501	6	200/600
YT-1502	7	200/600
YT-1503	8	200/600
YT-1505	10	200/600
YT-1507	12	200/600
YT-1508	13	200/600

EN Nut setter
PL Nasadka magnetyczna do wkrętarci
DE Magnet-Steckschlüssel mit Adapter
RU Магнитная головка для винтовёрта
CZ Nástrčný kľúč magnetický do vrtačky
HU Csavarbehajtó
RO Cheie tubulara cu prindere tip mandrina
FR Douille tournevis magnétique
IT Cappuccio magnetico la vite
ES Boquilla magnética de destornilladora
CN 磁性套筒

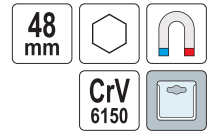

YATO	o [mm]	
YT-1511	6	100/200
YT-1512	7	100/200
YT-1513	8	100/200
YT-1515	10	100/200
YT-1517	12	100/200
YT-1518	13	100/200

EN Screwdriver bit holder
PL Uchwyt do końcówek śrubokrętowych
DE Bithalter

RU Магнитный держатель
CZ Držák na šroubovavékoncovky
HU Szár a csavarhúzóvégkekhez

RO Capete șurubelniță
FR Mandrin magnétique
IT Mandrino portapunta

ES Mandril para puntas
CN 旋具头磁性接杆



YATO	o [mm]	L [mm]	
YT-0465	1/4" (6.3 mm)	60	20/200

YATO	o [mm]	L [mm]	
YT-0466	1/4" (6.3 mm)	60	20/200

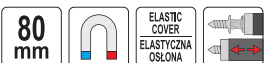

YATO	o [mm]	L [mm]	
YT-0467	1/4" (6.3 mm)	80	20/200

YATO	o [mm]	L [mm]	
YT-04671	1/4" (6.3 mm)	120	100

EN Screwdriver bit holder
 PL Uchwyt do końcówek śrubokrętowych
 DE Bithalter
 RU Магнитный держатель
 CZ Držák na šroubovákovekoncevky
 HU Szár a csavarhúzóvégekhöz
 RO Capete șurubelniță
 FR Mandrin magnétique
 IT Mandrino portapunta
 ES Mandril para puntas
 CN 磁具头磁性接杆

1/4"
6.3 mm

60
mm

QUICK RELEASE
SZYBKO-ZŁĄCZE

SS
STAINLESS STEEL
STAL NIERZYDZĄCA

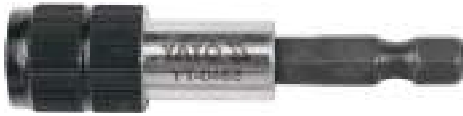

YATO		L [mm]	
YT-0468	1/4" (6.3 mm)	60	20/200

EN Screwdriver bit holder
 PL Uchwyt do końcówek śrubokrętowych
 DE Bithalter
 RU Магнитный держатель
 CZ Držák na šroubovákovekoncevky
 HU Szár a csavarhúzóvégekhöz
 RO Capete șurubelniță
 FR Mandrin magnétique
 IT Mandrino portapunta
 ES Mandril para puntas
 CN 螺丝批头接杆

1/4"
6.3 mm

150
mm

CrV



YATO		L [mm]	
YT-04695	1/4" (6.3 mm)	150	100

EN Swivel bit holder
 PL Adapter kątowny do bitów
 DE Gelenk-Bit-Adapter
 RU Адаптер для бит шарнирный
 CZ Držák na bity s jistěním
 HU Csuklós bit befogó
 RO Bit pivotant
 FR Porte embout pivotant
 IT Adattatore angolare per punte
 ES Adaptador articulado para puntas
 CN 万向接杆

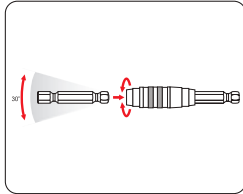

1/4"
6.3 mm

100
mm

CrV



YATO		L [mm]	
YT-04635	1/4" (6.3 mm)	60/120	

EN Keyless chuck snap-out
 PL Uchwyt wiertarski bezkluczkowy
 DE Schnellspann-Bohrfutter
 RU Патрон для дрели быстрозажимной
 CZ Sklíčidlo
 HU Bitbefogású gyorsstokmány
 RO Mandrina rapidă cu coada
 FR Mandrin sans clé
 IT Mandrino portapunte autoserrante
 ES Adaptador portabrocas
 CN 夹头

1/4"
6.3 mm

0.5-3.0
mm

50
mm



YATO		L [mm]	
YT-04644	1/4" (6.3 mm)	50/150	

EN Keyless chuck snap-out
 PL Uchwyt wiertarski bezkluczkowy
 DE Schnellspann-Bohrfutter
 RU Патрон для дрели быстрозажимной
 CZ Sklíčidlo
 HU Bitbefogású gyorsstokmány
 RO Mandrina rapidă cu coada
 FR Adaptador portabrocas
 IT Mandrino portapunte autoserrante
 ES Mandrin sans clé
 CN 夹头

1/4"
6.3 mm

0.5-6.5
mm

75
mm



YATO		L [mm]	
YT-04645	1/4" (6.3 mm)	10/60	

EN Screwdriver bit holder
 PL Uchwyt do końcówek śrubokrętowych
 DE Bithalter
 RU Магнитный держатель
 CZ Držák na šroubovákovekoncevky
 HU Szár a csavarhúzóvégekhöz

RO Capete șurubelniță
 FR Mandrin magnétique
 IT Mandrino portapunta
 ES Mandril para puntas
 CN 钻套

1/4"
6.3 mm



YATO		L [mm]	
YT-04681	1/4" (6.3 mm)	150	50/100
YT-04682	1/4" (6.3 mm)	200	50/100
YT-04683	1/4" (6.3 mm)	250	50/100
YT-04684	1/4" (6.3 mm)	300	50/100

EN Screwdriver bit holder set
 PL Zestaw uchwytów do bitów
 DE Bithalter-Set
 RU Набор держателей бит
 CZ Sada prodlžovacích úchytů pro bity
 HU Bitbefogó készlet
 RO Set prelungitoare biti
 FR Jeu de porte-embouts
 IT Kit portainserti
 ES Juego de portaherramientas
 CN 延长杆组套

3
PCS

1/4"
6.3 mm



1/4" (6.3 mm): 75, 100, 150 mm

YATO		L [mm]	
YT-04699	1/4" (6.3 mm)	20/120	

EN Adapter
 PL Adapter
 DE Adapter
 RU Адаптер

CZ Adaptér
 HU Adapter
 RO Adaptor
 FR Adaptateur

IT Adattatore
 ES Adaptador
 CN 转接杆

1/4"
6.3 mm

1/4"
6.3 mm

65
mm



YATO		L [mm]	
YT-04625	1/4" (6.3 mm)	65	40/120

EN Adapter
 PL Adapter
 DE Adapter
 RU Адаптер

CZ Adaptér
 HU Adapter
 RO Adaptor
 FR Adaptateur

1/4"
6.3 mm

3/8"
9.5 mm

65
mm

CrV



YATO		L [mm]	
YT-04626	1/4" (6.3 mm)	65	40/120

EN Adapter
 PL Adapter
 DE Adapter
 RU Адаптер

CZ Adaptér
 HU Adapter
 RO Adaptor
 FR Adaptateur

IT Adattatore
 ES Adaptador
 CN 转接杆

1/4"
6.3 mm

1/2"
12.7 mm

70
mm

CrV



YATO		L [mm]	
YT-04627	1/4" (6.3 mm)	70	40/120

EN Adapter
PL Adapter
DE Adapter
RU Адаптер

CZ Adaptér
HU Adapter
RO Adaptor
FR Adaptateur

IT Adattatore
ES Adaptador
CN 转接杆

3 PCS	 1/4" 6.3 mm	1/4" 6.3 mm	3/8" 9.5 mm
1/2" 12.7 mm	150 mm	CrV	

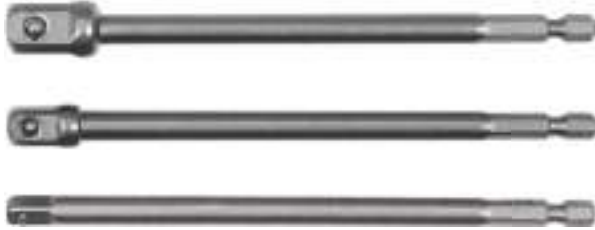



YATO 		L [mm]	
YT-04628	1/4" (6.3 mm)	150	24

EN Adapter
PL Adapter
DE Adapter
RU Адаптер



CZ Adaptér
HU Adapter
RO Adaptor
FR Adaptateur

IT Adattatore
ES Adaptador
CN 转接杆

8 PCS	 1/4" 6.3 mm	 3/8" 9.5 mm
1/2" 12.7 mm		





1/2" (12.7 mm): 50, 72 mm; 3/8" (9.5 mm): 50, 65 mm; 1/4" (6.3 mm): 25, 30, 50, 65 mm

YATO 		
YT-04639	1/4" (6.3 mm), 3/8" (9.5 mm), 1/2" (12.7 mm)	20/100

EN Adapter
PL Adapter
DE Adapter
RU Адаптер

CZ Adaptér
HU Adapter
RO Adaptor
FR Adaptateur

IT Adattatore
ES Adaptador
CN 接杆组套

SDS PLUS	 1/4" 6.3 mm	 3/8" 9.5 mm
1/2" 12.7 mm	65 mm	

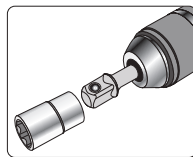



YATO 	
YT-04686	20/100



EN Adapter
PL Adapter
DE Adapter
RU Адаптер

CZ Adaptér
HU Adapter
RO Adaptor
FR Adaptateur

IT Adattatore
ES Adaptador
CN 接杆

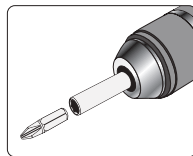
 1/4" 6.3 mm	SDS PLUS	60 mm
		



YATO 	L [mm]	
YT-04690	60	50/100

EN Adapter
PL Adapter
DE Adapter
RU Адаптер

CZ Adaptér
HU Adapter
RO Adaptor
FR Adaptateur

IT Adattatore
ES Adaptador
CN 转接杆

6 PCS	 1/4" 6.3 mm	1/4" 6.3 mm	3/8" 9.5 mm
1/2" 12.7 mm	50 mm	150 mm	CrV



YATO 		L [mm]	
YT-04629	1/4" (6.3 mm)	50, 150	24



EN Adapter
PL Adapter
DE Adapter
RU Адаптер

CZ Adaptér
HU Adapter
RO Adaptor
FR Adaptateur

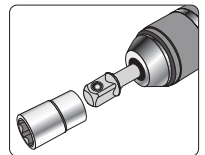

IT Adattatore
ES Adaptador
CN 六角柄接杆组套

 1/4" 6.3 mm	1/4" 6.3 mm	3/8" 9.5 mm
1/2" 12.7 mm	65 mm	73 mm





YATO 		
YT-04685	1/4" (6.3 mm)	20/100

EN Universal joint bit adapter set
PL Zestaw adapterów z przegubem
DE Kreuzgelenk-Adapter-Set
RU Набор переходников с шарниром
CZ Sada adaptérů s kloubem
HU Csuklós csavarhúzófej-adapter
RO Set de adaptoare cardanice
FR Jeu d'adapteurs avec joint
IT Kit adattatori con giunto
ES Conjunto de adaptadores con junta articulada
CN 万向接杆

3 PCS	 1/4" 6.3 mm	1/4" 6.3 mm	3/8" 9.5 mm	1/2" 12.7 mm
125 mm				



YATO 		
YT-04641	1/4" (6.3 mm)	12/36

EN Extension bar
PL Przedłużka elastyczna
DE Verlängerung
RU Удлинитель для воротка
CZ Prodlužovací přípravek
HU Toldalék

RO Prelungitor
FR Rallonge élastique
IT Prolunga flessibile
ES Tubo de prolongación
CN 可弯式接杆

1/4" 6.3 mm	150 mm	CrV	
6140			

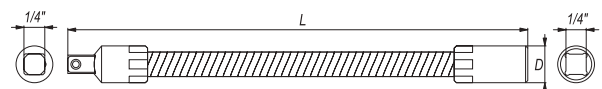

YATO 			D [mm]	L [mm]	PCS NOTE	
YT-1400	1/4" (6.3 mm)	1/4" (6.3 mm)	11.6	150	25	250/500

EN Extension bar
 PL Przedłużka elastyczna
 DE Verlängerung

RU Удлинитель для воротка
 CZ Prodlužovací přípravek
 HU Toldalék

RO Prelungitor
 FR Rallonge élastique
 IT Prolunga flessibile

ES Tubo de prolongación
 CN 柔性螺丝批头接杆

1/4" 300 mm CrV 6140

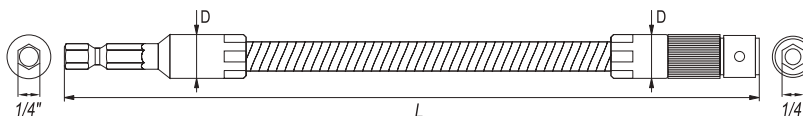

YATO	Ø	Ø	D [mm]	L [mm]	📦
YT-14001	1/4" (6.3 mm)	1/4" (6.3 mm)	11.7	300	100

EN Angled screwdriver bit holder
 PL Wkrętek kątowy do końcówek śrubokrętowych
 DE Winkelschrauber
 RU Г-образный держатель для бит
 CZ Šroubovák
 HU Csavarhúzó
 RO Prelungitor pt. biti, 90 grade
 FR Mandrin magnétique
 IT Cacciavite ad angolo per punte
 ES Porta pontas magnético
 CN 直角螺丝批接头

1/4" 105 mm 90°



YATO	Ø	L [mm]	📦
YT-04630	1/4" (6.3 mm)	105	60/240

EN Angle adapter
 PL Adapter kątowy
 DE Winkelschrauber
 RU Адаптер угловой для бит
 CZ Úhel elektrická vrtačka připojení adaptéru
 HU Sarokcsavarozó adapter
 RO Dispozitiv unghiular de insurubat
 FR Renvoi d'angle perceuse visseuse
 IT Adattatore
 ES Ángulo magnético bit driver adaptador
 CN 拐带柔性接杆

1/4" 37 mm 105° 12 Nm

1200 min⁻¹ SS STAINLESS STEEL STAL NERDZEWA



YATO	Ø	L [mm]	📦
YT-04632	1/4" (6.3 mm)	37	100

EN Angle adapter with extension
 PL Adapter kątowy z przedłużką
 DE Winkelschrauber
 RU Адаптер угловой для бит
 CZ Úhel elektrická vrtačka připojení adaptéru
 HU Sarokcsavarozó adapter
 RO Dispozitiv unghiular de insurubat
 FR Renvoi d'angle perceuse visseuse
 IT Adattatore
 ES Ángulo magnético bit driver adaptador
 CN 拐带柔性接杆

1/4" 325 mm 400 min⁻¹ 90° 13 Nm



YATO	Ø	L [mm]	📦
YT-04636	1/4" (6.3 mm)	325	10/60

EN Angle adapter
 PL Adapter kątowy
 DE Winkelschrauber
 RU Адаптер угловой для бит
 CZ Úhel elektrická vrtačka připojení adaptéru
 HU Sarokcsavarozó adapter
 RO Dispozitiv unghiular de insurubat
 FR Renvoi d'angle perceuse visseuse
 IT Adattatore
 ES Ángulo magnético bit driver adaptador
 CN 带手柄拐带柔性接杆

1/4" 155 mm 400 min⁻¹ 90° 13 Nm



YATO	Ø	L [mm]	📦
YT-04631	1/4" (6.3 mm)	155	50

EN T-handle key
PL Klucz typu „T”
DE T-Griff Stiftschlüssel
RU Ключ Т-образный с рукояткой

CZ Imbusový klíč s T-rukojetí
HU Imbuskulcs T-markolattal
RO Cheie tip „T”
FR Clé allen avec en „T”

IT Chiave a „T” per viti con impronta
ES Llave allen con mango en „T”
CN T型内六角扳手

S2

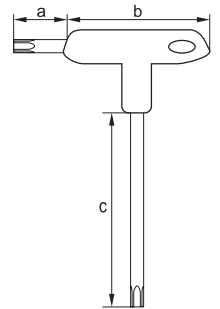
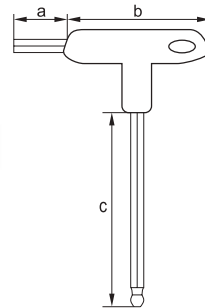
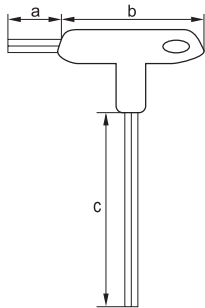

YATO	© [mm]	a [mm]	b [mm]	c [mm]	
YT-05571	2.5	13	76	100	12/240
YT-05572	3.0	13	76	100	12/240
YT-05574	4.0	13	76	140	12/240
YT-05576	5.0	17	92	140	12/144
YT-05577	6.0	17	92	170	12/144
YT-05578	7.0	17	92	170	12/144
YT-05579	8.0	22	102	200	12/96
YT-05581	10.0	22	102	200	12/96

YATO	© [mm]	a [mm]	b [mm]	c [mm]	
YT-05585	2.5	13	76	100	12/240
YT-05586	3.0	13	76	100	12/240
YT-05588	4.0	13	76	140	12/240
YT-05590	5.0	17	92	140	12/144
YT-05591	6.0	17	92	170	12/144
YT-05592	7.0	17	92	170	12/144
YT-05593	8.0	22	102	200	12/96
YT-05594	10.0	22	102	200	12/96

YATO		a [mm]	b [mm]	c [mm]	
YT-05601	T8	13	76	100	12/240
YT-05602	T9	13	76	100	12/240
YT-05603	T10	13	76	100	12/240
YT-05604	T15	13	76	100	12/240
YT-05605	T20	13	76	130	12/240
YT-05606	T25	13	76	130	12/240
YT-05607	T27	17	92	140	12/144
YT-05608	T30	17	92	170	12/144
YT-05609	T40	17	92	170	12/144
YT-05610	T45	22	102	200	12/96
YT-05611	T50	22	102	200	12/96

EN T-handle key
PL Klucz typu „T”
DE T-Griff Stiftschlüssel
RU Ключ Т-образный с рукояткой

CZ Imbusový klíč s T-rukojetí
HU Imbuskulcs T-markolattal
RO Cheie tip „T”
FR Clé allen avec en „T”

IT Chiave a „T” per viti con impronta
ES Llave allen con mango en „T”
CN T型内六角扳手组套

8
PCS



S2



YATO	© [mm]	a [mm]	b [mm]	c [mm]	
YT-05583	2.5, 3, 4, 5, 6, 7, 8, 10	13, 13, 13, 17, 17, 17, 22, 22	76, 76, 76, 92, 92, 92, 102, 102	100, 100, 140, 140, 170, 170, 200, 200	12/24

YATO	© [mm]	a [mm]	b [mm]	c [mm]	
YT-05597	2.5, 3, 4, 5, 6, 7, 8, 10	13, 13, 13, 17, 17, 17, 22, 22	76, 76, 76, 92, 92, 92, 102, 102	100, 100, 140, 140, 170, 170, 200, 200	12/24

EN T-handle key
 PL Klucz typu „T”
 DE T-Griff Stiftschlüssel
 RU Ключ Т-образный с рукояткой
 CZ Imbusový klíč s T-rukojetí
 HU Imbuskulcs T-markolattal
 RO Cheie tip „T”
 FR Clé Allen avec en „T”
 IT Chiave a „T” per viti con impronta
 ES Llave Allen con mango en „T”
 CN T型星型内六角扳手组套

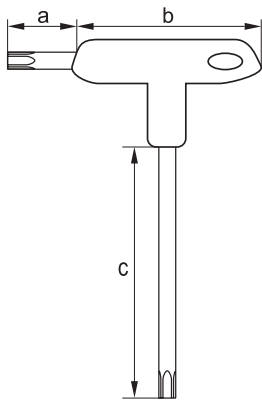

9 PCS

S2



YATO	⊙	a [mm]	b [mm]	c [mm]	📦
YT-05615	T10, T15, T20,	13, 13, 13, 13,	76, 76, 76, 76,	100, 100, 100,	12/24
	T25, T27, T30,	17, 17, 17,	92, 92, 92, 102,	140, 140, 170,	
	T40, T45, T50	22, 22	102	170, 200, 200	

EN Hex and Torx key set
 PL Zestaw kluczy trzypieniowych
 DE Sechskant und Torx Stiftschlüsselsatz
 RU Набор ключей Hex и Torx
 CZ Sada klíčů imbusových a Torx
 HU Kulcskészlet imbisz és Torx
 RO Set de chei imbus și Torx
 FR Ensemble clés Hex et Torx
 IT Set di chiavi a brugola
 ES Juego de llaves hexagonales y Torx
 CN 内六角组套

26 PCS

CrV



⊙ 1.5, 2, 2.5, 3, 4, 4.5, 5, 5.5, 6 mm; 5/64" (2.0 mm), 3/32" (2.4 mm), 7/64" (2.8 mm), 1/8" (3.2 mm), 9/64" (3.6 mm), 5/32" (4.0 mm), 3/16" (4.8 mm), 7/32" (5.6 mm), 1/4" (6.3 mm); CrV;
 Ⓢ T9, T10, T15, T20, T25, T27, T30, T40; CrV

YATO	📦
YT-05644	6/20

EN Hex and Torx key set
 PL Zestaw kluczy trzypieniowych
 DE Sechskant und Torx Stiftschlüsselsatz
 RU Набор ключей Hex и Torx
 CZ Sada klíčů imbusových a Torx
 HU Kulcskészlet imbisz és Torx
 RO Set de chei imbus și Torx
 FR Ensemble clés Hex et Torx
 IT Set di chiavi a brugola
 ES Juego de llaves hexagonales y Torx
 CN 内六角组套

24 PCS

CrV



⊙ 1.5, 2, 2.5, 3, 4, 5, 6, 8 mm; 1/16" (1.6 mm), 5/64" (2.0 mm), 3/32" (2.4 mm), 1/8" (3.2 mm), 9/64" (3.6 mm), 5/32" (4.0 mm), 3/16" (4.8 mm), 1/4" (6.3 mm); CrV;
 Ⓢ T6, T7, T8, T9, T10, T15, T20, T25; CrV

YATO	📦
YT-05640	10/40

EN Hex key
 PL Klucz sześciokątny
 DE Sechskant-Stiftschlüssel
 RU Шестигранный
 CZ Imbusový klíč
 HU Imbisz kulcs
 RO Cheie imbus
 FR Clé Allen
 IT Chiave a brugola
 ES Llave hexagonal
 CN 六角螺丝批

LONG DLUGI

CrV

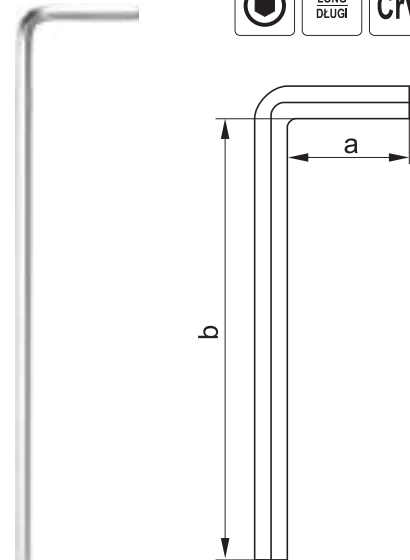

YATO	⊙ [mm]	a [mm]	b [mm]	📦
YT-05430	1.5	14	78	250/2000
YT-05431	2.0	16	83	250/2000
YT-05432	2.5	18	90	250/1500
YT-05433	3.0	20	100	250/1500
YT-05434	4.0	25	105	250/1000
YT-05436	5.0	27	116	100/600
YT-05438	6.0	32	137	100/500
YT-05439	7.0	34	150	100/300
YT-05440	8.0	36	155	50/200
YT-05441	9.0	38	165	25/125
YT-05442	10.0	40	170	25/125
YT-05443	12.0	47	210	25/75
YT-05444	14.0	57	236	25/50
YT-05445	17.0	63	250	15/30
YT-05446	19.0	70	280	10/20

EN Hex key
PL Klucz sześciokątny
DE Sechskant-Stiftschlüssel
RU Шестигранный
CZ Imbusový klíč
HU Imbusz kulcs
RO Cheie imbus
FR Clé Allen
IT Chiave a brugola
ES Llave hexagonal
CN 六角螺丝批

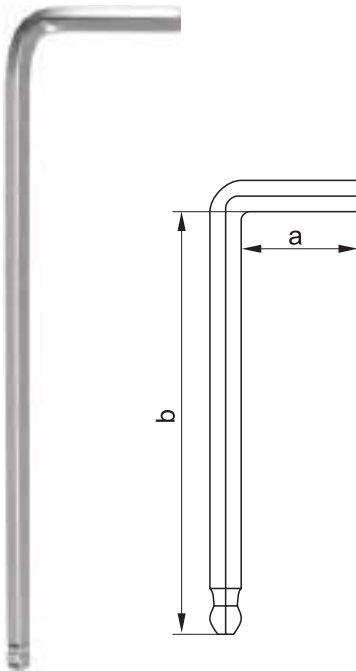

YATO	⊙ [mm]	a [mm]	b [mm]	📦
YT-05450	1.5	14	78	250/2000
YT-05451	2.0	16	83	250/2000
YT-05452	2.5	18	90	250/2000
YT-05453	3.0	20	100	250/1500
YT-05454	4.0	25	105	250/1000
YT-05456	5.0	27	116	100/600
YT-05458	6.0	32	137	100/500
YT-05459	7.0	34	150	100/300
YT-05460	8.0	36	155	50/200
YT-05461	9.0	38	165	25/125
YT-05462	10.0	40	170	25/125
YT-05463	12.0	47	210	25/75
YT-05464	14.0	57	236	25/50
YT-05465	17.0	63	250	15/30
YT-05466	19.0	70	280	10/20

EN Torx key
PL Klucz Torx
DE Torx-Stiftschlüssel
RU Ключ Торх
CZ Klíč Torx
HU Kulcs Torx
RO Cheie Torx
FR Clé Torx
IT Chiave Torx
ES Llave Torx
CN 内六角螺丝批

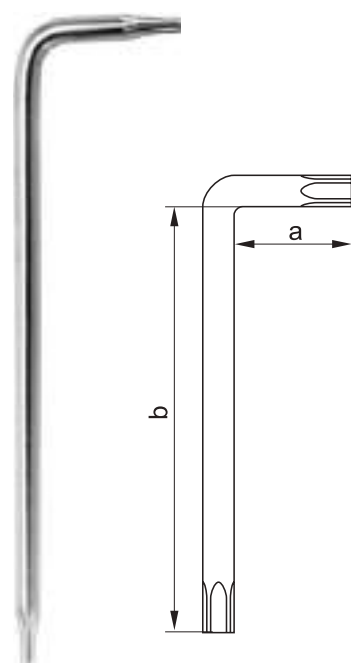

YATO	⊙	a [mm]	b [mm]	📦
YT-05490	T6	16	66	250/2000
YT-05491	T7	16	71	250/2000
YT-05492	T8	16	80	250/2000
YT-05493	T9	16	80	250/2000
YT-05494	T10	17	86	250/2000
YT-05495	T15	17	90	250/2000
YT-05496	T20	19	95	100/1000
YT-05497	T25	20	100	250/1000
YT-05498	T27	21	105	100/1000
YT-05499	T30	24	114	50/600
YT-05501	T40	28	121	50/400

EN Torx key
PL Klucz Torx
DE Torx-Stiftschlüssel
RU Ключ Торх
CZ Klíč Torx
HU Kulcs Torx
RO Cheie Torx
FR Clé Torx
IT Chiave Torx
ES Llave Torx
CN 内六角螺丝批

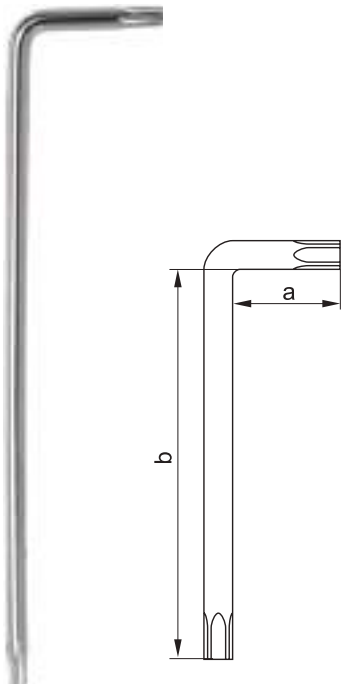

YATO	⊙	a [mm]	b [mm]	📦
YT-05514	T10	17	86	250/2000
YT-05515	T15	17	90	250/2000
YT-05516	T20	19	95	250/1000
YT-05517	T25	20	100	250/1000
YT-05518	T27	21	105	250/1000
YT-05519	T30	24	114	50/600
YT-05520	T40	28	121	50/400

EN Torx key set
PL Zestaw kluczy Torx
DE Torx-Stiftschlüsselsatz
RU Набор ключей Торх
CZ Souprava klíčů Torx
HU Torx kulcskészlet
RO Set de chei Torx
FR Set de clés Torx
IT Set di chiavi a brugola Torx
ES Juego de llaves Torx
CN 内六角螺丝批

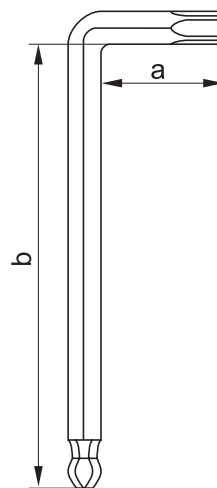

YATO	⊙	a [mm]	b [mm]	📦
YT-05123	T9, T10, T15, T20, T25, T27, T30, T40	18, 18, 19, 20, 21, 23, 25, 27	85, 90, 95, 100, 107, 115, 123, 132	10/100

EN Hex key set
 PL Zestaw kluczy imbusowych
 DE Sechskant-Stiftschlüsselsatz
 RU Набор шестигранников
 CZ Imbusové klíče
 HU Imbisz kulcs
 RO Chei imbus
 FR Set de clés allen
 IT Set di chiavi a brugola
 ES Juego de llaves hex
 CN 内六角扳手组套

12 PCS SAE CrV 6150

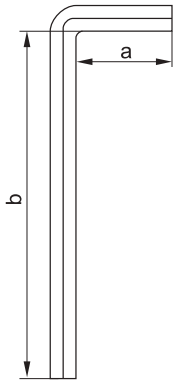

25° LONG DEUGI

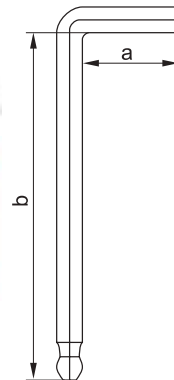

25° EXTRA LONG EKSTRA DŁUGI

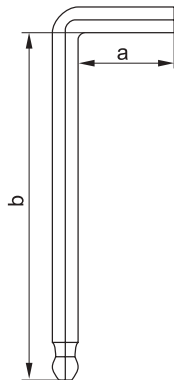

YATO	⊙	a [mm]	b [mm]	
YT-5835	1/16" (1.6 mm),			6/36
	5/64" (2.0 mm),			
	3/32" (2.4 mm),			
	7/64" (2.8 mm),	74, 79, 83,		
	1/8" (3.2 mm),	14, 16, 17,	74, 79, 83,	
	9/64" (3.6 mm),	18, 19, 20,	88, 93, 99,	
	5/32" (4.0 mm),	21, 24, 25,	105, 113,	
	3/16" (4.8 mm),	28, 32, 35,	122, 132,	
	7/32" (5.6 mm),		150, 170	
	1/4" (6.3 mm),			
5/16" (7.9 mm),				
3/8" (9.5 mm)				

YATO	⊙	a [mm]	b [mm]	
YT-5837	1/16" (1.6 mm),			6/36
	5/64" (2.0 mm),			
	3/32" (2.4 mm),			
	7/64" (2.8 mm),	74, 79, 83,		
	1/8" (3.2 mm),	14, 16, 17,	74, 79, 83,	
	9/64" (3.6 mm),	18, 19, 20,	88, 93, 99,	
	5/32" (4.0 mm),	21, 24, 25,	105, 113,	
	3/16" (4.8 mm),	28, 32, 35,	122, 132,	
	7/32" (5.6 mm),		150, 170	
	1/4" (6.3 mm),			
5/16" (7.9 mm),				
3/8" (9.5 mm)				

YATO	⊙	a [mm]	b [mm]	
YT-5838	1/16" (1.6 mm),			6/36
	5/64" (2.0 mm),			
	3/32" (2.4 mm),			
	7/64" (2.8 mm),	91, 100,		
	1/8" (3.2 mm),	14, 16, 17,	91, 100,	
	9/64" (3.6 mm),	18, 19, 20,	110, 116,	
	5/32" (4.0 mm),	21, 24, 25,	123, 130,	
	3/16" (4.8 mm),	28, 32, 35,	132, 150,	
	7/32" (5.6 mm),		165, 185,	
	1/4" (6.3 mm),		200, 233	
5/16" (7.9 mm),				
3/8" (9.5 mm)				

EN Hex key set
 PL Zestaw kluczy imbusowych
 DE Sechskant-Stiftschlüsselsatz
 RU Набор шестигранников
 CZ Imbusové klíče
 HU Imbisz kulcs
 RO Chei imbus
 FR Set de clés allen
 IT Set di chiavi a brugola
 ES Juego de llaves hex
 CN 内六角扳手组套

HRC 52-56 CrV 6150

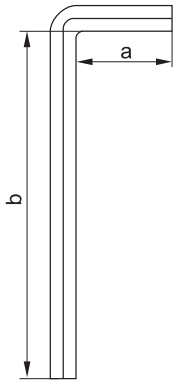

9 PCS

YATO	⊙ [mm]	a [mm]	b [mm]	
YT-0500	1.5, 2, 2.5, 3, 4, 5, 6, 8, 10	15, 16, 18, 21, 23, 28, 31, 35, 39	74, 81, 88, 95, 109, 121, 135, 157, 174	6/36

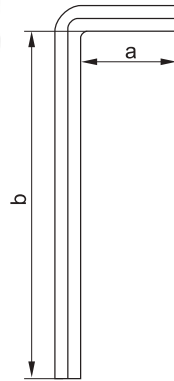
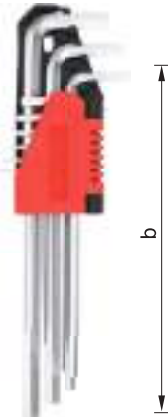

9 PCS

YATO	⊙ [mm]	a [mm]	b [mm]	
YT-0501	1.5, 2, 2.5, 3, 4, 5, 6, 8, 10	15, 16, 18, 21, 23, 28, 31, 35, 39	90, 96, 112, 125, 142, 157, 180, 201, 225	6/36

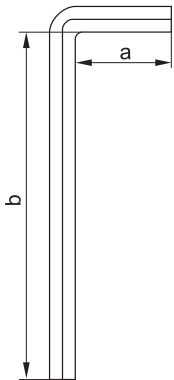

9 PCS

YATO	⊙ [mm]	a [mm]	b [mm]	
YT-0502	2, 2.5, 3, 4, 5, 6, 7, 8, 10	16, 18, 21, 23, 28, 31, 33, 35, 39	81, 88, 95, 109, 121, 135, 145, 157, 174	6/36

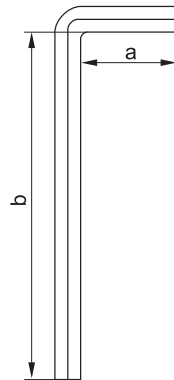

10 PCS

YATO	⊙ [mm]	a [mm]	b [mm]	
YT-0508	2, 2.5, 3, 4, 5, 6, 7, 8, 10, 12	16, 18, 21, 23, 28, 31, 33, 35, 39, 42	81, 88, 95, 109, 121, 135, 145, 157, 174, 180	6/36

EN Hex key set
PL Zestaw kluczy imbusowych
DE Sechskant-Stiftschlüsselsatz
RU Набор шестигранных

CZ Imbusové klíče
HU Imbisz kulcs
RO Chei imbus
FR Set de clés allen

IT Set di chiavi a brugola
ES Juego de llaves hex
CN 内六角扳手组套



HRC 52-56

CrV 6150

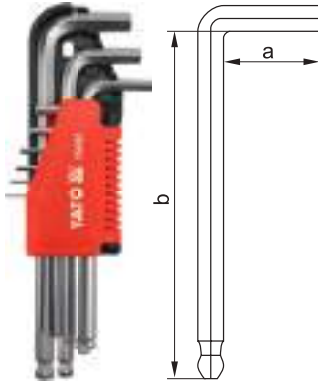

9 PCS

YATO	⌀ [mm]	a [mm]	b [mm]	
YT-0505	1.5, 2, 2.5, 3, 4, 5, 6, 8, 10	15, 16, 18, 21, 23, 28, 31, 35, 39	74, 81, 88, 95, 109, 121, 135, 157, 174	6/36

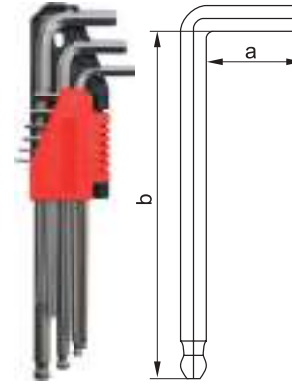

9 PCS

YATO	⌀ [mm]	a [mm]	b [mm]	
YT-0506	1.5, 2, 2.5, 3, 4, 5, 6, 8, 10	15, 16, 18, 21, 23, 28, 31, 35, 39	90, 96, 112, 125, 142, 157, 180, 201, 225	6/36

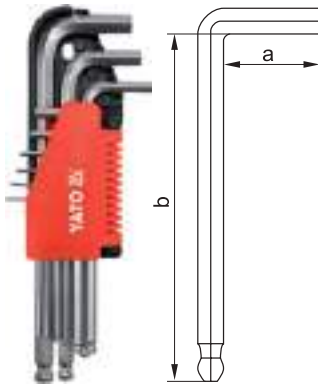

9 PCS

YATO	⌀ [mm]	a [mm]	b [mm]	
YT-0507	2, 2.5, 3, 4, 5, 6, 7, 8, 10	16, 18, 21, 23, 28, 31, 33, 35, 39	81, 88, 95, 109, 121, 135, 145, 157, 174	6/36

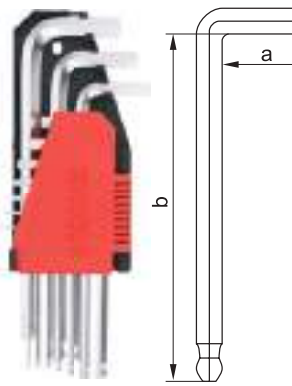

10 PCS

YATO	⌀ [mm]	a [mm]	b [mm]	
YT-0509	2, 2.5, 3, 4, 5, 6, 7, 8, 10, 12	16, 18, 21, 23, 28, 31, 33, 35, 39, 42	81, 88, 95, 109, 121, 135, 145, 157, 174, 180	6/36

EN Hex key set
PL Zestaw kluczy imbusowych
DE Sechskant-Stiftschlüsselsatz
RU Набор шестигранных

CZ Imbusové klíče
HU Imbisz kulcs
RO Chei imbus
FR Set de clés allen

IT Set di chiavi a brugola
ES Juego de llaves hex
CN 内六角组套



CrV 6150

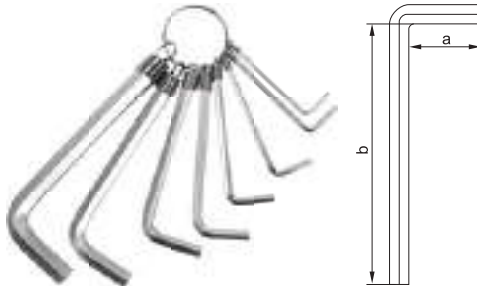

8 PCS

YATO	⌀ [mm]	a [mm]	b [mm]	
YT-0503	2, 2.5, 3, 4, 5, 6, 8, 10	14, 16, 17, 21, 22, 27, 32, 38	50, 53, 60, 66, 74, 81, 93, 104	12/72



10 PCS

YATO	⌀ [mm]	a [mm]	b [mm]	
YT-0504	1.5, 2, 2.5, 3, 4, 5, 6, 7, 8, 10	12, 14, 16, 17, 21, 22, 27, 31, 32, 38	43, 50, 53, 60, 66, 74, 81, 86, 93, 104	12/72

EN Hex key set
PL Zestaw kluczy imbusowych
DE Sechskant-Stiftschlüsselsatz
RU Набор шестигранных
CZ Imbusové klíče
HU Imbisz kulcs
RO Chei imbus
FR Set de clés Allen
IT Set di chiavi a brugola
ES Juego de llaves Hex
CN 内六角扳手组套

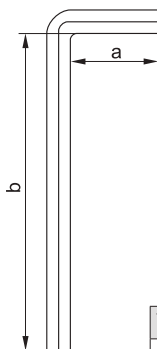

10 PCS



HRC 52-55

CrV 6150



YATO	⌀ [mm]	a [mm]	b [mm]	
YT-0519	3, 4, 5, 5.5, 6, 8, 10, 12, 14, 17	20, 25, 28, 30, 32, 35, 42, 49, 57, 65	125, 140, 160, 170, 180, 200, 220, 250, 285, 320	5

5



EN TORX key set
 PL Zestaw kluczy TORX
 DE TORX-Stiftschlüsselsatz
 RU Набор ключей TORX

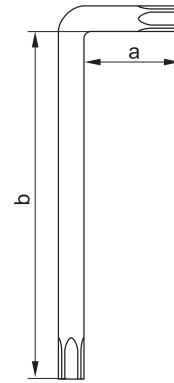
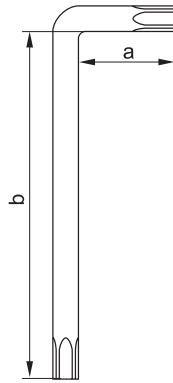

CZ Souprava klíčů TORX
 HU Kulcskészlet, TORX
 RO Set de chei TORX
 FR Set de clés allen

IT Set di chiavi a brugola
 ES Juego de llaves TORX
 CN 内六角扳手组套

9 PCS  HRC 52-56 CrV 6150 



YATO		a [mm]	b [mm]	
YT-0511	T10, T15, T20, T25, T27, T30, T40, T45, T50	15, 16, 17, 21, 24, 27, 32, 36, 38	72, 79, 86, 94, 107, 122, 133, 155, 174	6/36

YATO		a [mm]	b [mm]	
YT-0512	T10, T15, T20, T25, T27, T30, T40, T45, T50	15, 16, 19, 23, 26, 27, 32, 36, 41	78, 95, 109, 124, 143, 153, 180, 200, 222	6/36



EN Hex key set
 PL Zestaw kluczy imbusowych
 DE Sechskant-Stiftschlüsselsatz
 RU Набор шестигранников

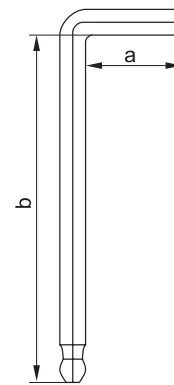
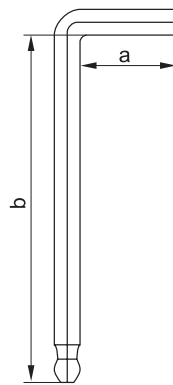

CZ Imbusové klíče
 HU Imbisz kulcs
 RO Chei imbus
 FR Set de clés allen

IT Set di chiavi a brugola
 ES Juego de llaves hex
 CN 内六角组套

10 PCS  25°  



YATO		© [mm]	a [mm]	b [mm]	
YT-0560		1.27, 1.5, 2, 2.5, 3, 4, 5, 6, 8, 10	12, 14, 16, 18, 18, 21, 27, 32, 35, 38	73, 76, 82, 89, 99, 104, 115, 138, 161, 179	12/48

YATO		© [mm]	a [mm]	b [mm]	
YT-0561		1.27, 1.5, 2, 2.5, 3, 4, 5, 6, 8, 10	10, 12, 15, 17, 19, 23, 28, 32, 36, 50	78, 89, 98, 110, 124, 140, 159, 179, 198, 232	12/48

EN TORX key set
 PL Zestaw kluczy TORX
 DE TORX-Stiftschlüsselsatz
 RU Набор ключей TORX



CZ Souprava klíčů TORX
 HU Kulcskészlet, TORX
 RO Set de chei TORX
 FR Set de clés allen

IT Set di chiavi a brugola
 ES Juego de llaves TORX
 CN 内六角组套

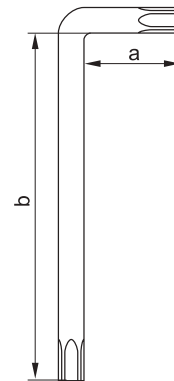
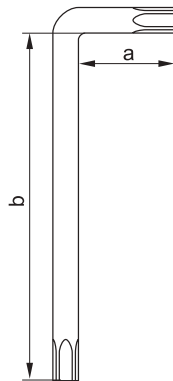

 S2 



7 PCS

YATO		a [mm]	b [mm]	
YT-0562	T9, T10, T15, T20, T25, T27, T30	18, 19, 19, 19, 22, 24, 26	78, 85, 93, 103, 113, 123, 132	12/48

9 PCS

YATO		a [mm]	b [mm]	
YT-0563	T10, T15, T20, T25, T27, T30, T40, T45, T50	14, 14, 16, 18, 23, 27, 30, 35, 41	87, 97, 108, 123, 137, 158, 177, 197, 216	12/48

- EN Hex key set
PL Zestaw kluczy imbusowych
DE Sechskant-Stiftschlüsselsatz
RU Набор ключи торцовых шестигранных
CZ Imbusové klíče
HU Imbisz kulcs
RO Chei imbus
FR Set de clés allen
IT Set di chiavi a brugola
ES Llaves hexagonales
CN 内六角扳手组套

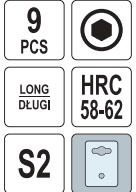
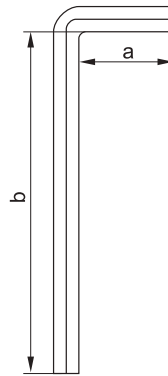

YATO	◎ [mm]	a [mm]	b [mm]	
YT-05631	1.5, 2, 2.5, 3, 4, 5, 6, 8, 10	14.5, 16, 17.5, 21, 23, 27, 30, 33, 38	78.5, 83, 90.5, 99, 110, 122, 138, 152, 166	10/50

- EN Hex key set
PL Zestaw kluczy imbusowych
DE Sechskant-Stiftschlüsselsatz
RU Набор ключи торцовых шестигранных
CZ Imbusové klíče
HU Imbisz kulcs
RO Chei imbus
FR Set de clés allen
IT Set di chiavi a brugola
ES Llaves hexagonales
CN 内六角扳手组套

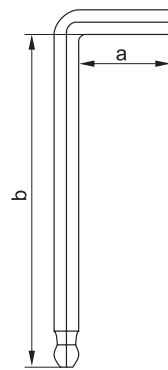

YATO	◎ [mm]	a [mm]	b [mm]	
YT-05632	1.5, 2, 2.5, 3, 4, 5, 6, 8, 10	14.5, 16, 17.5, 21, 23, 27, 30, 33, 38	78.5, 83, 90.5, 99, 110, 122, 138, 152, 166	10/50

- EN Torx key set
PL Zestaw kluczy Torx
DE Torx Schlüsselsatz
RU Набор ключи Torx
CZ Souprava klíčů Torx
HU Kulcskészlet Torx
RO Set de chei Torx
FR Set de clés Torx
IT Set di chiavi a brugola Torx
ES Juego de llaves Torx
CN 内六角扳手组套

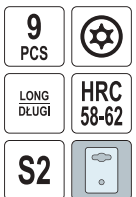
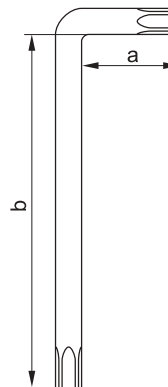

YATO	◎	a [mm]	b [mm]	
YT-05633	T10, T15, T20, T25, T27, T30, T40, T45, T50	15, 17.7, 19.2, 20.75, 23.25, 25.5, 28.2, 34.2, 36.2	83, 90.7, 98.2, 106.75, 113.25, 129.5, 139.2, 149.2, 161.2	10/50

6

Pliers Szczypce



Pliers, CrV
Szczypce, CrV

104



Combination pliers	104
Szczypce uniwersalne	104
Side cutting pliers	104
Szczypce tnące, boczne	104
Long nose pliers	104
Szczypce wydłużone, proste	104
Bent nose pliers	104
Szczypce wydłużone, wygięte	104

Pliers
Szczypce

104-105



Combination pliers	104
Szczypce uniwersalne	104
Side cutting pliers	104
Szczypce tnące, boczne	104
Long nose pliers	104
Szczypce wydłużone, proste	104
Bent nose pliers	104
Szczypce wydłużone, wygięte	104
Flat nose pliers	104
Szczypce płaskie	104
Round nose pliers	104
Szczypce okrągłe	104
Wire stripping pliers	105
Szczypce do ściągania izolacji	105
End cutting pliers	105
Szczypce tnące, czołowe	105

Pliers, CrV
Szczypce, CrV

105



Combination pliers	105
Szczypce uniwersalne	105
Side cutting pliers	105
Szczypce tnące, boczne	105

Pliers
Szczypce

105



Combination pliers	105
Szczypce uniwersalne	105
Side cutting pliers	105
Szczypce tnące, boczne	105

Double joint pliers
Szczypce przegubowe

105



Double joint long nose pliers	105
Szczypce wydłużone proste przegubowe	105
Double joint bent nose pliers	105
Szczypce wydłużone wygięte przegubowe	105

Mini pliers
Szczypce „Mini”

106



Combination pliers	106
Szczypce uniwersalne	106
Side cutting pliers	106
Szczypce tnące, boczne	106

Long nose pliers	106
Szczypce wydłużone, proste	106
Bent nose pliers	106
Szczypce wydłużone, wygięte	106
Flat nose pliers	106
Szczypce płaskie	106
Round nose pliers	106
Szczypce okrągłe	106
End cutting pliers	106
Szczypce tnące, czołowe	106

Plastics & cables cutting pliers
Szczypce do cięcia plastiku i kabli

107



Side cutting pliers	107
Szczypce tnące, boczne	107
Long nose pliers	107
Szczypce wydłużone, proste	107

Carpenter's pliers & tower pincers
Obcęgi i szczypce

108



Carpenter's pliers	108
Obcęgi	108
Tower pincers	108
Szczypce tynkarskie	108

Heavy duty side cutting pliers
Szczypce tnące, boczne

108



End cutting pliers	108
Szczypce tnące czołowe	108

Circlip pliers
Szczypce Segera

108-110



Lock grip pliers	110-112
Szczypce zaciskowe	110-112

Lock grip pliers	110
Szczypce zaciskowe, uniwersalne	110
Welding locking pliers	110
Szczypce zaciskowe, spawalnicze	110
Flat locking pliers	112
Szczypce zaciskowe o szerokich szczękach	112
C-type welding locking pliers	112
Szczypce zaciskowe, kłamrowe typu „C”	112
Chain locking pliers	112
Szczypce zaciskowe z łańcuchem	112

Profile connection & forming pliers
Szczypce do łączenia i kształtowania profili

112-113



EN Combination pliers
 PL Szczypce uniwersalne
 DE Kombinationszange
 RU Плоскогубцы универсальные
 CZ Kleště kombinované
 HU Kombináltfogó

RO Patent universal
 FR Pince universelle
 IT Pinze universali
 ES Alicates universales
 CN 钢丝钳

DIN 5746 **HRC 58-62** **HRC 44-50** **CrV 55**



• Application: industry
 • Induction hardening
 • Przeznaczenie: przemysł
 • Hartowane indukcyjnie

YATO	L [mm]	
YT-1940	160	6/60
YT-1941	180	6/60
YT-1942	200	6/36

EN Long nose pliers
 PL Szczypce wydłużone proste
 DE Radiozange
 RU Тонкогубцы прямые
 CZ Prodloužené kleště rovné
 HU Rádiófogó, egyenes

RO Clește cu vârf ascuțit
 FR Pince prolongée
 IT Pinze lunghe dritte
 ES Alicates de punta
 CN 尖嘴钳

DIN 5746 **HRC 44-50** **HRC 58-62** **CrV 55**



• Application: industry
 • Induction hardening
 • Przeznaczenie: przemysł
 • Hartowane indukcyjnie

YATO	L [mm]	
YT-1943	160	6/60
YT-1944	200	6/60

EN Combination pliers
 PL Szczypce uniwersalne
 DE Kombinationszange
 RU Плоскогубцы универсальные

CZ Kleště kombinované
 HU Kombináltfogó
 RO Patent universal
 FR Pince universelle

IT Pinze universali
 ES Alicates universales
 CN 钢丝钳

DIN 5746 **NICKEL PLATED NIKLOWANE**



YATO	L [mm]	
YT-2006	160	6/60
YT-2007	180	6/60
YT-2008	200	6/36

EN Long nose pliers
 PL Szczypce wydłużone proste
 DE Radiozange
 RU Тонкогубцы прямые
 CZ Prodloužené kleště rovné
 HU Rádiófogó, egyenes

RO Clește cu vârf ascuțit
 FR Pince prolongée
 IT Pinze lunghe dritte
 ES Alicates de punta
 CN 尖嘴钳

DIN 5746 **NICKEL PLATED NIKLOWANE**



YATO	L [mm]	
YT-2016	160	6/60
YT-2018	200	6/60

EN Flat nose pliers
 PL Szczypce płaskie
 DE Flachzange
 RU Плоскогубцы удлиненные
 CZ Kleště ploché
 HU Rádiófogó, egyenes

RO Clește cu vârf ascuțit
 FR Pince plate
 IT Pinze piatte
 ES Alicates de bocas planas
 CN 平嘴钳

160 mm **DIN 5745** **NICKEL PLATED NIKLOWANE**



YATO	L [mm]	
YT-2029	160	6/60

EN Diagonal side cutting pliers
 PL Szczypce tnące boczne
 DE Seitenschneider
 RU Бокорезы
 CZ Řezací kleště boční
 HU Oldal csípőfogó

RO Olește tăietor
 FR Pince à coupe latérale
 IT Pinze taglianti laterali
 ES Alicates corte lateral
 CN 斜嘴钳

DIN 5746 **HRC 44-50** **HRC 58-62** **CrV 55**



• Application: industry
 • Induction hardening
 • Przeznaczenie: przemysł
 • Hartowane indukcyjnie

YATO	L [mm]	
YT-1947	160	6/60
YT-1948	190	6/60

EN Bent nose pliers
 PL Szczypce wydłużone wygięte
 DE Telefonzange
 RU Тонкогубцы изогнутые
 CZ Prodloužené kleště ohnuté
 HU Rádió- és telefonfogó, hajlítot

RO Clește cu vârf ascuțit indoit
 FR Pince prolongée cambrée
 IT Pinze a punta mezzo tonde
 ES Alicates de punta curvos
 CN 弯嘴钳

DIN 5746 **HRC 44-50** **HRC 58-62** **CrV 55**

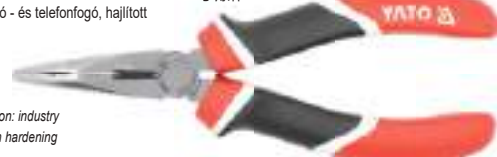

• Application: industry
 • Induction hardening
 • Przeznaczenie: przemysł
 • Hartowane indukcyjnie



YATO	L [mm]	
YT-1945	160	6/60
YT-1946	200	6/60

EN Diagonal side cutting pliers
 PL Szczypce tnące boczne
 DE Seitenschneider
 RU Бокорезы

CZ Řezací kleště boční
 HU Oldal csípőfogó
 RO Olește tăietor
 FR Pince à coupe latérale

IT Pinze taglianti laterali
 ES Alicates corte lateral
 CN 斜口钳

DIN 5746 **NICKEL PLATED NIKLOWANE**



YATO	L [mm]	
YT-2036	160	6/60
YT-2037	180	6/60

EN Bent nose pliers
 PL Szczypce wydłużone wygięte
 DE Telefonzange
 RU Тонкогубцы изогнутые
 CZ Prodloužené kleště ohnuté
 HU Rádió- és telefonfogó, hajlítot

RO Clește cu vârf ascuțit indoit
 FR Pince prolongée cambrée
 IT Pinze a punta mezzo tonde
 ES Alicates de punta curvos
 CN 弯嘴钳

DIN 5746 **NICKEL PLATED NIKLOWANE**



YATO	L [mm]	
YT-2026	160	6/60
YT-2028	200	6/60

EN Round nose pliers
 PL Szczypce okrągłe
 DE Rundzange
 RU Круглогубцы
 CZ Kleště kulaté
 HU Kerekcsőrű fogó

RO Patent rotund
 FR Pince ronde
 IT Pinze tonde
 ES Alicates de punta redonda
 CN 圆嘴钳

160 mm **DIN 5745** **NICKEL PLATED NIKLOWANE**



YATO	L [mm]	
YT-2030	160	6/60

EN Wire stripping pliers
PL Szczypce do ściągania izolacji
DE Abisolierzange
RU Пасатики для зачистки проводов
CZ Kleště odizolovací na drát
HU Blankoló fogó
RO Decablator
FR Pince à l'isolation
IT Pinze spelafili
ES Pinzas pelacables
CN 剥线钳



160
mm

DIN
5745

NICKEL
PLATED
NIKLOWANE



YATO	L [mm]	
YT-2031	160	6/60

EN Combination pliers
PL Szczypce uniwersalne
DE Kombinationszange
RU Плоскогубцы универсальные
CZ Kleště kombinované
HU Kombináltfogó

RO Patent universal
FR Pince universelle
IT Pinze universali
ES Alicates universales
CN 钢丝钳

HRC
55-62

CrV



YATO	L [mm]	
YT-6600	160	6/60
YT-6601	180	6/60
YT-6602	200	6/36

EN Diagonal side cutting pliers
PL Szczypce tnące boczne
DE Seitenschneider
RU Бокорезы
CZ Rezačí kleště boční
HU Oldal csipőfogó
RO Olește tăietor
FR Pince à coupe latérale
IT Pinze taglianti laterali
ES Alicates corte lateral
CN 重型斜嘴钳



180
mm

HRC
55-62

CrV



YATO	L [mm]	
YT-6612	180	6/60

EN Diagonal side cutting pliers
PL Szczypce tnące boczne
DE Seitenschneider
RU Бокорезы
CZ Rezačí kleště boční
HU Oldal csipőfogó

RO Olește tăietor
FR Pince à coupe latérale
IT Pinze taglianti laterali
ES Alicates corte lateral
CN 省力斜丝钳

160
mm

HIGH
LEVERAGE
ZWIĘKSZONA
SIŁA NACISKU



YATO	L [mm]	
YT-6583	160	6/60

EN Double joint bent nose pliers
PL Szczypce wydłużone wygięte przegubowe
DE Kneifzange verlängert gebogen 2 Gelenke
RU Плоскогубцы изогнутые 2 шарнира
CZ Prodloužené kleště zahnuté se zdvojeným kloubem
HU Hosszú hajlított 2 csuklós fogó

RO Cleste cu falci curbate
FR Pince allongée coudée à 2 articulations
IT Pinza lunga piegata con 2 giunti
ES Alicates de pinzas largas curvadas 2 articulaciones
CN 弯嘴钳

330
mm

45°

HRC
50

CrV



YATO	L [mm]	
YT-20401	330	5/50



EN End cutting pliers
PL Szczypce tnące czolowe
DE Vornscheider
RU Кусачки торцевые
CZ Kleště štípačí čelní
HU Homlokcsipő fogó
RO Cleste relezat
FR Coupe devant
IT Pinza a taglio laterale
ES Cortacables frontales
CN 顶切钳



DIN
5748

NICKEL
PLATED
NIKLOWANE



YATO	L [mm]	
YT-2066	160	6/60
YT-2067	180	6/60

EN Diagonal side cutting pliers
PL Szczypce tnące boczne
DE Seitenschneider
RU Бокорезы
CZ Rezačí kleště boční
HU Oldal csipőfogó

RO Olește tăietor
FR Pince à coupe latérale
IT Pinze taglianti laterali
ES Alicates corte lateral
CN 斜嘴钳

HRC
55-62

CrV



YATO	L [mm]	
YT-6610	160	6/60
YT-6611	180	6/60

EN Combination pliers
PL Szczypce uniwersalne
DE Kombinationszange
RU Плоскогубцы универсальные
CZ Kleště kombinované
HU Kombináltfogó

RO Patent universal
FR Pince universelle
IT Pinze universali
ES Alicates universales
CN 省力钢丝钳

HIGH
LEVERAGE
ZWIĘKSZONA
SIŁA NACISKU



YATO	L [mm]	
YT-6581	160	6/60
YT-6582	200	6/36

EN Double joint long nose pliers
PL Szczypce wydłużone proste przegubowe
DE Kneifzange verlängert gerade 2 Gelenke
RU Плоскогубцы прямые 2 шарнира
CZ Prodloužené kleště rovné se zdvojeným kloubem
HU Hosszú egyenes 2 csuklós fogó

RO Cleste cu falci lungi
FR Pince allongée droite à 2 articulations
IT Pinza lunga dritta con 2 giunti
ES Alicates de pinzas largas rectas 2 articulaciones
CN 尖嘴钳

340
mm

HRC
50

CrV



YATO	L [mm]	
YT-20400	340	5/50

EN Double joint bent nose pliers
PL Szczypce wydłużone wygięte przegubowe
DE Kneifzange verlängert gebogen 2 Gelenke
RU Плоскогубцы изогнутые 2 шарнира
CZ Prodloužené kleště zahnuté se zdvojeným kloubem
HU Hosszú hajlított 2 csuklós fogó

RO Cleste cu falci curbate
FR Pince allongée coudée à 2 articulations
IT Pinza lunga piegata con 2 giunti
ES Alicates de pinzas largas curvadas 2 articulaciones
CN 弯嘴钳

330
mm

90°

HRC
50

CrV



YATO	L [mm]	
YT-20402	330	5/50



EN Combination pliers
 PL Szczypce uniwersalne
 DE Kombinationszange
 RU Плоскогубцы универсальные
 CZ Kleště kombinované
 HU Kombináltfogó
 RO Patent universal
 FR Pince universelle
 IT Pinze universali
 ES Alicates universales
 CN 迷你钢丝钳

115 mm
 NICKEL PLATED
 NIKLOWANE 





YATO  L [mm] 
 YT-2080 115 6/120

EN Long nose pliers
 PL Szczypce wydłużone proste
 DE Radiozange
 RU Тонкогубцы прямые
 CZ Prodloužené kleště rovné
 HU Rádiófogó, egyenes
 RO Clește cu vârf ascuțit
 FR Pince prolongée
 IT Pinze lunghe diritte
 ES Alicates de punta
 CN 迷你尖嘴钳

115 mm
 NICKEL PLATED
 NIKLOWANE 





YATO  L [mm] 
 YT-2083 115 6/120

EN Flat nose pliers
 PL Szczypce płaskie
 DE Flachzange
 RU Плоскогубцы удлиненные
 CZ Kleště ploché
 HU Rádiófogó, egyenes
 RO Clește cu vârf ascuțit
 FR Pince plate
 IT Pinze piatte
 ES Alicates de bocas planas
 CN 迷你平口钳

115 mm
 NICKEL PLATED
 NIKLOWANE 



YATO  L [mm] 
 YT-2085 115 6/120

EN End cutting pliers
 PL Szczypce tnące czołowe
 DE Vornschnneider
 RU Кусачки торцевые
 CZ Kleště štípací čelní
 HU Homlokcsípő fogó
 RO Clește rețezat
 FR Coupe devant
 IT Pinza a taglio laterale
 ES Cortacables frontales
 CN 迷你顶切钳



115 mm
 NICKEL PLATED
 NIKLOWANE 

YATO  L [mm] 
 YT-2082 115 6/120

EN Round nose pliers
 PL Szczypce okrągłe
 DE Rundzange
 RU Круглогубцы
 CZ Kleště kulaté
 HU Kerekcsőrű fogó
 RO Patent rotund
 FR Pince ronde
 IT Pinze tonde
 ES Alicates de punta redonda
 CN 迷你圆嘴钳

115 mm
 NICKEL PLATED
 NIKLOWANE 



YATO  L [mm] 
 YT-2086 115 6/120

EN Diagonal side cutting pliers
 PL Szczypce tnące boczne
 DE Seitenschneider
 RU Бокорезы
 CZ Řezací kleště boční
 HU Oldal csípőfogó
 RO Olește tăietor
 FR Pince à coupe latérale
 IT Pinze taglianti laterali
 ES Alicates corte lateral
 CN 迷你斜口钳

115 mm
 NICKEL PLATED
 NIKLOWANE 





YATO  L [mm] 
 YT-2081 115 6/120

EN Bent nose pliers
 PL Szczypce wydłużone wygięte
 DE Telefonzange
 RU Тонкогубцы изогнутые
 CZ Prodloužené kleště ohnuté
 HU Rádió - és telefonfogó, hajlított
 RO Clește cu vârf ascuțit îndoit
 FR Pince prolongée cambrée
 IT Pinze a punta mezzo tonde
 ES Alicates de punta curvos
 CN 迷你弯嘴钳

115 mm
 NICKEL PLATED
 NIKLOWANE 



YATO  L [mm] 
 YT-2084 115 6/120

EN Diagonal side cutting pliers
PL Szczypce tnące boczne
DE Seitenschneider
RU Бокорезы
CZ Řezací kleště boční
HU Oldal csípőfogó
RO Olește tăietor
FR Pince à coupe latérale
IT Pinze taglianti laterali
ES Alicates corte lateral
CN 塑料水口钳



125
mm

max ∅
3.0
mm

HRC
56-62

HRC
43-48

CrV
60



YATO
YT-1950

L [mm]
125

6/120

EN Diagonal side cutting pliers
PL Szczypce tnące boczne
DE Seitenschneider
RU Бокорезы
CZ Řezací kleště boční
HU Oldal csípőfogó
RO Olește tăietor
FR Pince à coupe latérale
IT Pinze taglianti laterali
ES Alicates corte lateral
CN 塑料水口钳



150
mm

max ∅
5.0
mm

HRC
56-62

HRC
43-48

CrV
60



YATO
YT-1951

L [mm]
150

6/120

EN Diagonal side cutting pliers
PL Szczypce tnące boczne
DE Seitenschneider
RU Бокорезы
CZ Řezací kleště boční
HU Oldal csípőfogó
RO Olește tăietor
FR Pince à coupe latérale
IT Pinze taglianti laterali
ES Alicates corte lateral
CN 塑料水口钳



180
mm

max ∅
6.0
mm

HRC
56-62

HRC
43-48

CrV
60



YATO
YT-1952

L [mm]
180

6/60

EN Diagonal side cutting pliers
PL Szczypce tnące boczne
DE Seitenschneider
RU Бокорезы
CZ Řezací kleště boční
HU Oldal csípőfogó
RO Olește tăietor
FR Pince à coupe latérale
IT Pinze taglianti laterali
ES Alicates corte lateral
CN 电子斜嘴钳



100
mm

max ∅
1.0mm
STEEL
STAL

max ∅
1.8mm
Cu

HRC
56-62

HRC
43-48

CrV
60



YATO
YT-1953

L [mm]
100

6/120

EN Diagonal side cutting pliers
PL Szczypce tnące boczne
DE Seitenschneider
RU Бокорезы
CZ Řezací kleště boční
HU Oldal csípőfogó
RO Olește tăietor
FR Pince à coupe latérale
IT Pinze taglianti laterali
ES Alicates corte lateral
CN 电子斜嘴钳



125
mm

max ∅
1.2mm
STEEL
STAL

max ∅
2.0mm
Cu

HRC
56-62

HRC
43-48

CrV
60



YATO
YT-1954

L [mm]
125

6/120

EN Long nose pliers
PL Szczypce wydłużone proste
DE Radiozange
RU Тонкогубцы прямые
CZ Prodloužené kleště rovné
HU Rádiófogó, egyenes
RO Clește cu vârf ascuțit
FR Pince prolongée
IT Pinze lunghe diritte
ES Alicates de punta
CN 电子长嘴钳



150
mm

max ∅
1.5mm
STEEL
STAL

max ∅
2.6mm
Cu

HRC
56-62

HRC
43-48

CrV
60



YATO
YT-1956

L [mm]
150

6/120

EN Carpenter's pliers
 PL Obcegi
 DE Kneifzange
 RU Клещи строительные
 CZ Kleště
 HU Harapófógó
 RO Cleste cuie
 FR Tenailles
 IT Tenaglie
 ES Tenazas
 CN 胡桃钳

DIN 5748



YATO	L [mm]	
YT-2046	160	6/60
YT-2047	180	6/60
YT-2048	200	6/60

EN Tower pincers
 PL Obcegi tynkarskie
 DE Beisszange
 RU Клещи штукатурные
 CZ Kleště štrpaci čelní
 HU Rabitzfógó
 RO Cleste pt. cuie
 FR Tenaille russe
 IT Tenaglie tronchesi
 ES Tenazas de enlucido
 CN 扎线钳

DIN 5748



YATO	L [mm]	
YT-2058	200	6/60
YT-2060	250	6/36
YT-2061	275	6/36

6

EN Tower pincers
 PL Obcegi tynkarskie
 DE Beisszange
 RU Клещи штукатурные
 CZ Kleště štrpaci čelní
 HU Rabitzfógó
 RO Cleste pt. cuie
 FR Tenaille russe
 IT Tenaglie tronchesi
 ES Tenazas de enlucido
 CN 木工铅笔

250 mm **DIN 5746** **HRC 44-50** **HRC 58-62** **CrV 55**



YATO	L [mm]	
YT-1949	250	6/36

EN Heavy duty side cutting pliers
 PL Szczypce tnące boczne
 DE Seitenschneider, Schwer Typ
 RU Бокорезы усиленные
 CZ Řezací kleště boční
 HU Oldal csípőfógó
 RO Olește tăietor
 FR Pince à coupe latérale
 IT Pinze taglianti laterali
 ES Alicates de corte lateral tipo pesado
 CN 重型斜口钳

180 mm **DIN 5749** **NICKEL PLATED NIKLOWANE**



YATO	L [mm]	
YT-2039	180	6/60

EN Carpenter's pliers
 PL Obcegi
 DE Kneifzange
 RU Клещи строительные
 CZ Kleště
 HU Harapófógó
 RO Cleste cuie
 FR Tenailles
 IT Tenaglie
 ES Tenazas
 CN 胡桃钳

HRC 55-60 **CrV 50**



YATO	L [mm]	Max. cutting capacity in cold rolled steel / Maks. grubość cięcia w stali walcowanej na zimno [mm]	
YT-2050	150	1.5	6/60
YT-2051	175	1.8	6/60
YT-2052	200	2.0	6/48

EN Tower pincers
 PL Obcegi tynkarskie
 DE Beisszange
 RU Клещи штукатурные
 CZ Kleště štrpaci čelní
 HU Rabitzfógó
 RO Cleste pt. cuie
 FR Tenaille russe
 IT Tenaglie tronchesi
 ES Tenazas de enlucido
 CN 扎线钳

HRC 55-62 **CrV 50**



YATO	L [mm]	Max. cutting capacity in cold rolled steel / Maks. grubość cięcia w stali walcowanej na zimno [mm]	
YT-2055	225	1.8	6/60
YT-2056	250	2.0	6/48
YT-2057	275	2.2	6/24

EN End cutting pliers
 PL Szczypce tnące czolowe
 DE Vornscheider
 RU Кусачки торцевые
 CZ Kleště štrpaci čelní
 HU Homlokcsípőfógó
 RO Cleste retezat
 FR Coupe devant
 IT Pinza a taglio laterale
 ES Cortacables frontales
 CN 顶切钳

HRC 55-60 **CrV 50**



YATO	L [mm]	Max. cutting capacity in cold rolled steel / Maks. grubość cięcia w stali walcowanej na zimno [mm]	
YT-2063	175	1.5	6/48
YT-2064	200	1.8	6/48

EN Circlip pliers
 PL Szczypce Seegera
 DE Seegering-Zange
 RU Съёмник стопорных колец
 CZ Kleště na pojistné kroužky
 HU Seegerfógó

RO Clește Seger
 FR Pince à anneau Seeger
 IT Pinza per anelli Seeger
 ES Alicates Seger
 CN 挡圈钳

5 PCS **160 mm** **10-50 mm**



YATO	L [mm]	
YT-2130	160	20/60

EN Circlip pliers
PL Szczypce Segera
DE Seegering-Zange
RU Съёмник стопорных колец
CZ Kleště na pojistné kroužky
HU Segerfogó

RO Clește Seger
FR Pince à anneau Seeger
IT Pinza per anelli Seeger
ES Alicata Seger
CN 挡圈钳

180
mm



HRC
42-48

CrV
50



YATO	L [mm]	
YT-2136	180	6/24

EN Circlip pliers
PL Szczypce Segera
DE Seegering-Zange
RU Съёмник стопорных колец
CZ Kleště na pojistné kroužky
HU Segerfogó

RO Clește Seger
FR Pince à anneau Seeger
IT Pinza per anelli Seeger
ES Alicata Seger
CN 挡圈钳

180
mm



HRC
42-48

CrV
50



YATO	L [mm]	
YT-2138	180	6/24

EN Circlip pliers
PL Szczypce Segera
DE Seegering-Zange
RU Съёмник стопорных колец
CZ Kleště na pojistné kroužky
HU Segerfogó

RO Clește Seger
FR Pince à anneau Seeger
IT Pinza per anelli Seeger
ES Alicata Seger
CN 挡圈钳

180
mm



HRC
42-48

CrV
50



YATO	L [mm]	
YT-2137	180	6/24

EN Circlip pliers
PL Szczypce Segera
DE Seegering-Zange
RU Съёмник стопорных колец
CZ Kleště na pojistné kroužky
HU Segerfogó

RO Clește Seger
FR Pince à anneau Seeger
IT Pinza per anelli Seeger
ES Alicata Seger
CN 挡圈钳

180
mm



HRC
42-48

CrV
50



YATO	L [mm]	
YT-2139	180	6/24

EN Circlip pliers
PL Szczypce Segera
DE Seegering-Zange
RU Съёмник стопорных колец
CZ Kleště na pojistné kroužky
HU Segerfogó

RO Clește Seger
FR Pince à anneau Seeger
IT Pinza per anelli Seeger
ES Alicata Seger
CN 挡圈钳



CrV

NICKEL
PLATED
NIKLOWANE



YATO	L [mm]	
YT-2140	150	6/120
YT-2144	200	6/60

EN Circlip pliers
PL Szczypce Segera
DE Seegering-Zange
RU Съёмник стопорных колец
CZ Kleště na pojistné kroužky
HU Segerfogó

RO Clește Seger
FR Pince à anneau Seeger
IT Pinza per anelli Seeger
ES Alicata Seger
CN 挡圈钳



CrV

NICKEL
PLATED
NIKLOWANE



YATO	L [mm]	
YT-2141	150	6/120
YT-2145	200	6/60

EN Circlip pliers
PL Szczypce Segera
DE Seegering-Zange
RU Съёмник стопорных колец
CZ Kleště na pojistné kroužky
HU Segerfogó

RO Clește Seger
FR Pince à anneau Seeger
IT Pinza per anelli Seeger
ES Alicata Seger
CN 挡圈钳



CrV

NICKEL
PLATED
NIKLOWANE



YATO	L [mm]	
YT-2142	150	6/60
YT-2146	200	6/60

EN Circlip pliers
PL Szczypce Segera
DE Seegering-Zange
RU Съёмник стопорных колец
CZ Kleště na pojistné kroužky
HU Segerfogó

RO Clește Seger
FR Pince à anneau Seeger
IT Pinza per anelli Seeger
ES Alicata Seger
CN 挡圈钳



CrV

NICKEL
PLATED
NIKLOWANE



YATO	L [mm]	
YT-2143	150	6/120
YT-2147	200	6/60

EN Circlip pliers
PL Szczypce Segeera
DE Seegering-Zange
RU Съёмник стопорных колец
CZ Kleště na pojistné kroužky
HU Seegerfogó



RO Clește Seger
FR Pince à anneau Seeger
IT Pinza per anelli Seeger
ES Alicates Seger
CN 挡圈钳



CrV

NICKEL
PLATED
NIKLOWANE



YATO 	L [mm]	
YT-1988	225	6/60
YT-1992	325	6/48

EN Circlip pliers
PL Szczypce Segeera
DE Seegering-Zange
RU Съёмник стопорных колец
CZ Kleště na pojistné kroužky
HU Seegerfogó



RO Clește Seger
FR Pince à anneau Seeger
IT Pinza per anelli Seeger
ES Alicates Seger
CN 挡圈钳



CrV

NICKEL
PLATED
NIKLOWANE



YATO 	L [mm]	
YT-1989	225	6/60
YT-1993	325	6/48

EN Circlip pliers
PL Szczypce Segeera
DE Seegering-Zange
RU Съёмник стопорных колец
CZ Kleště na pojistné kroužky
HU Seegerfogó



RO Clește Seger
FR Pince à anneau Seeger
IT Pinza per anelli Seeger
ES Alicates Seger
CN 挡圈钳



CrV

NICKEL
PLATED
NIKLOWANE



YATO 	L [mm]	
YT-1990	225	6/60
YT-1994	325	6/48

EN Circlip pliers
PL Szczypce Segeera
DE Seegering-Zange
RU Съёмник стопорных колец
CZ Kleště na pojistné kroužky
HU Seegerfogó



RO Clește Seger
FR Pince à anneau Seeger
IT Pinza per anelli Seeger
ES Alicates Seger
CN 挡圈钳



CrV

NICKEL
PLATED
NIKLOWANE



YATO 	L [mm]	
YT-1991	225	6/60
YT-1995	325	6/48

EN Lock grip pliers
PL Szczypce Morse'a
DE Gripzange
RU Зажим ручной



CZ Kleště Morse'a
HU Morse fogó
RO Clește Morse
FR Pincés de serrage Morse

IT Pinze Morse
ES Alicates Morse
CN 圆口大力钳

WR
TYPE

CrV



YATO 	L [mm]	
YT-2151	140	6/48
YT-2152	180	6/36
YT-2153	240	6/36

EN Lock grip pliers
PL Szczypce Morse'a
DE Gripzange
RU Зажим ручной



CZ Kleště Morse'a
HU Morse fogó
RO Clește Morse
FR Pincés de serrage Morse

IT Pinze Morse
ES Alicates Morse
CN 尖嘴大力钳

CD
TYPE

CrV



YATO 	L [mm]	
YT-2155	165	6/48
YT-2156	220	6/36

EN Locking pliers
PL Szczypce zaciskowe
DE Klemmzange
RU Клещи давяльные

CZ Kleště samosvorné
HU Patentfogó
RO Clește de strângere
FR Pincés de serrage Morse

IT Pinze Morse
ES Pinzas de tornillo (de apriete)
CN 圆口大力钳

125 mm

CrMo



YATO 	L [mm]	
YT-2449	125	6/24

EN Locking pliers
PL Szczypce zaciskowe
DE Klemmzange
RU Клещи давяльные

CZ Kleště samosvorné
HU Patentfogó
RO Clește de strângere
FR Pincés de serrage Morse

IT Pinze Morse
ES Pinzas de tornillo (de apriete)
CN 直口大力钳

250 mm

CrMo





YATO 	L [mm]	
YT-2453	250	6/24

EN Locking pliers
PL Szczypce zaciskowe
DE Klemmzange
RU Клещи давяльные
CZ Kleště samosvorné
HU Patentfogó

RO Clește de strângere
FR Pinces de serrage Morse
IT Pinze Morse
ES Pinzas de tornillo (de apriete)
CN 圆口大力钳

180 mm
CrMo





YATO  L [mm] 
YT-2450 180 6/24

EN Locking pliers
PL Szczypce zaciskowe
DE Klemmzange
RU Клещи давяльные
CZ Kleště samosvorné
HU Patentfogó

RO Clește de strângere
FR Pinces de serrage Morse
IT Pinze Morse
ES Pinzas de tornillo (de apriete)
CN 尖嘴大力钳

150 mm
CrMo





YATO  L [mm] 
YT-2459 150 6/24

EN Locking pliers
PL Szczypce zaciskowe
DE Klemmzange
RU Клещи давяльные
CZ Kleště samosvorné
HU Patentfogó

RO Clește de strângere
FR Pinces de serrage Morse
IT Pinze Morse
ES Pinzas de tornillo (de apriete)
CN 直口大力钳

180 mm
CrMo





YATO  L [mm] 
YT-2452 180 6/24

EN Locking pliers
PL Szczypce zaciskowe
DE Klemmzange
RU Клещи давяльные
CZ Kleště samosvorné
HU Patentfogó

RO Clește de strângere
FR Pinces de serrage Morse
IT Pinze Morse
ES Pinzas de tornillo (de apriete)
CN 大力钳

250 mm
0-42 mm
CrMo





YATO  L [mm] 
YT-2476 250 6/24

EN Locking pliers
PL Szczypce zaciskowe
DE Klemmzange
RU Клещи давяльные
CZ Kleště samosvorné
HU Patentfogó

RO Clește de strângere
FR Pinces de serrage Morse
IT Pinze Morse
ES Pinzas de tornillo (de apriete)
CN 圆口大力钳

250 mm
CrMo



YATO  L [mm] 
YT-2451 250 6/24

EN Locking pliers
PL Szczypce zaciskowe
DE Klemmzange
RU Клещи давяльные
CZ Kleště samosvorné
HU Patentfogó

RO Clește de strângere
FR Pinces de serrage Morse
IT Pinze Morse
ES Pinzas de tornillo (de apriete)
CN 尖嘴大力钳

225 mm
CrMo



YATO  L [mm] 
YT-2460 225 6/24

EN Locking pliers
PL Szczypce zaciskowe
DE Klemmzange
RU Клещи давяльные
CZ Kleště samosvorné
HU Patentfogó

RO Clește de strângere
FR Pinces de serrage Morse
IT Pinze Morse
ES Pinzas de tornillo (de apriete)
CN 大力钳

250 mm
0-42 mm
CrMo



YATO  L [mm] 
YT-2473 250 6/24

EN Sliding arm welding locking pliers
PL Szybkonastawne szczypce spawalnicze
DE Parallel-gripzange
RU Образная струбицина с захватом
CZ Paralelné samosvorné kleště
HU Szorítórúdas ónzáró fogó
RO Clește de mana cu prindere tip menhina
FR Pince-étai - serre-joint coulissant
IT Pinze regolabili autobloccanti
ES Pinzas de presión tipo sargento
CN 大力钳

260 mm
0-150 mm
QUICK ADJUSTMENT
SZYBKĄ REGULACJĄ



YATO  L [mm] 
YT-21570 260 2/16

EN Welding locking pliers
 PL Szczypce zaciskowe spawalnicze
 DE Klemmzange zum Schweißen
 RU Клещи давяльные сварочные
 CZ Kleště samosvorné svářečské
 HU Hegesztő fogó

RO Clește de strângere pt. sudură
 FR Pincés de serrage pour soudeur
 IT Pinze di bloccaggio per saldatura
 ES Pinzas de tornillo (de apriete) para soldar
 CN 焊接用大力钳

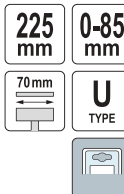

YATO	L [mm]	
YT-2461	225	6/24

EN C-type welding locking pliers
 PL Szczypce zaciskowe kłamrowe typu „C”
 DE Klemm- und Klammerzange vom Typ „C”
 RU Клещи давяльные типа „C”
 CZ Kleště samosvorné upínací typu „C”
 HU „C” fogó

RO Clește de strângere cu clemă tip „C”
 FR Pince de serrage type „C”
 IT Pinze di bloccaggio tipo „C”
 ES Pinzas de tornillo (de apriete) de grapa tipo „C”
 CN C型大力钳

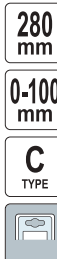

YATO	L [mm]	
YT-2466	280	6/24

EN Chain locking pliers
 PL Szczypce zaciskowe z łańcuchem
 DE Klemmzange mit Kette
 RU Клещи давяльные с цепью
 CZ Kleště samosvorné s řetězem
 HU Láncos csőfogó

RO Clește de strângere cu lanț
 FR Pince de serrage avec une chaîne
 IT Pinze di bloccaggio con la catena
 ES Pinzas de tornillo (de apriete) con cadena
 CN 链条大力钳

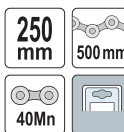

YATO	L [mm]	
YT-2469	250	6/24

EN Flat locking pliers
 PL Szczypce zaciskowe o szerokich szczękach
 DE Klemmzange mit breiten Backen
 RU Клещи давяльные с широкими губками
 CZ Kleště samosvorné se širokými čelistmi
 HU Lapos fogó

RO Clește de strângere plat / patent
 FR Pince de serrage large
 IT Pinze con ganasce piane e paletta
 ES Pinzas de tornillo (de apriete) con mordazas anchas
 CN 铁皮大力钳

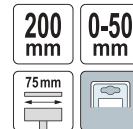

YATO	L [mm]	
YT-2463	200	6/24

EN C-type welding locking pliers
 PL Szczypce zaciskowe kłamrowe typu „C”
 DE Klemm- und Klammerzange vom Typ „C”
 RU Клещи давяльные типа „C”
 CZ Kleště samosvorné upínací typu „C”
 HU „C” fogó

RO Clește de strângere cu clemă tip „C”
 FR Pince de serrage type „C”
 IT Pinze di bloccaggio tipo „C”
 ES Pinzas de tornillo (de apriete) de grapa tipo „C”
 CN C型大力钳

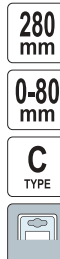

YATO	L [mm]	
YT-2468	280	6/24

EN Stud crimper
 PL Szczypce do łączenia profili
 DE Profil Verbundzange
 RU Клещи для соединения профилей
 CZ Kleště do spojování profilů
 HU Profilösszekötő fogó

RO Cleste sertizat profile rigide
 FR Pince pour assembler des profilés
 IT Alicates para perfis
 ES Alicates para unir perfiles
 CN 龙骨钳





YATO	L [mm]	
YT-5130	275	6/24

EN Stud crimper
PL Szczypce do łączenia profili
DE Profil Verbundzange
RU Клещи для соединения профилей
CZ Kleště do spojování profilů
HU Profilösszekítő fogó

RO Cleste sertizat profile rigips
FR Pince pour assembler des profilés
IT Alicata para perfis
ES Alicates para unir perfiles
CN 龙骨钳

345 mm
0.5-0.8 mm SECTION THICKNESS GRUBOSĆC PROFIŁU
65Mn
PUNCH PUNKTAK





YATO 	L [mm]	
YT-5131	345	6/24

EN Stud crimper
PL Szczypce do łączenia profili
DE Profil Verbundzange
RU Клещи для соединения профилей
CZ Kleště do spojování profilů
HU Profilösszekítő fogó

RO Cleste sertizat profile rigips
FR Pince pour assembler des profilés
IT Alicata para perfis
ES Alicates para unir perfiles
CN 龙骨钳

260 mm
0.5-0.8 mm SECTION THICKNESS GRUBOSĆC PROFIŁU
ST12
65Mn
PUNCH PUNKTAK





YATO 	L [mm]	
YT-51312	260	6/24

EN Stud crimper
PL Szczypce do łączenia profili
DE Profil Verbundzange
RU Клещи для соединения профилей
CZ Kleště do spojování profilů
HU Profilösszekítő fogó

RO Cleste sertizat profile rigips
FR Pince pour assembler des profilés
IT Alicata para perfis
ES Alicates para unir perfiles
CN 新款长柄龙骨钳

280 mm
0.5-0.8 mm SECTION THICKNESS GRUBOSĆC PROFIŁU
A380
AlTi
HEAD GLOWICA
GR15
PUNCH PUNKTAK





YATO 	L [mm]	
YT-51311	280	6/24

EN Stud crimper
PL Szczypce do łączenia profili
DE Profil Verbundzange
RU Клещи для соединения профилей
CZ Kleště do spojování profilů
HU Profilösszekítő fogó

RO Cleste sertizat profile rigips
FR Pince pour assembler des profilés
IT Alicata para perfis
ES Alicates para unir perfiles
CN 龙骨钳

320 mm
HRC 50
40Cr





YATO 	L [mm]	
YT-51303	320	6/24

EN Punch pliers
PL Szczypce do dziurkowania blach
DE Blech Lochzange
RU Прокататель круглых отверстий
CZ Děrovací kleště
HU Fogó peremező lyukasztó

RO Cleste pt. perforat
FR Trou pincés feuilles
IT Pinza per forare lamiera
ES Punzonadora una mano perfiles
CN 打孔钳

240 mm
3.2 mm
GR15
PUNCH PUNKTAK



YATO 	L [mm]	
YT-51320	240	5/30

EN Punch kit
PL Ręczny dziurkacz do blach
DE Handlochstanze für Blech
RU Ручной перфоратор для листового металла
CZ Ruční děrovač plechů
HU Kézi fémlemez lyukasztó
RO Set cleste perforat
FR Perforateur à main pour tôle
IT Punzonatrice manuale per lamiera
ES Perforadora manual para chapas
CN 打孔钳

16 PCS
max **1.0 mm** PLATE BLADA



Ø 2, 3, 4, 4.5, 5.5, 6, 7 mm

YATO 	L [mm]	
YT-18973		12

EN Profile forming pliers
PL Szczypce do kształtowania profili
DE Zange zur Formgebung der Profile
RU Щипцы для формировки профилей

CZ Kleště k tvarování profilů
HU Profilformázó fogó
RO Cleste pt. modelarea profilelor
FR Pince pour former les profiles

IT Pinze per la formazione di profili
ES Pinzas para formar perfiles
CN 龙骨钳

210 mm



80x35 mm

YATO 	L [mm]	
YT-5140	210	2/12



80x35 mm

YATO 	L [mm]	
YT-5141	210	2/12



150x35 mm

YATO 	L [mm]	
YT-5142	210	2/12

7

Electrician tools Narzędzia dla elektryków





Insulated screwdrivers Wkrętki izolowane		116-117
--	---	---------

Insulated slotted screwdrivers Wkrętki izolowane płaskie	116
Insulated phillips screwdrivers Wkrętki izolowane krzyżakowe	116
Insulated Pozidrive screwdrivers Wkrętki izolowane „Pozidrive”	116
Insulated screwdriver sets Komplety wkrętek izolowanych	116

Insulated pliers Szczypce izolowane		117
---	---	-----

Combination pliers Szczypce uniwersalne	117
Side cutting pliers Szczypce tnące, boczne	117
Long nose pliers Szczypce wydłużone, proste	117
Wire stripping pliers Szczypce do ściągania izolacji	117
Water pump pliers Szczypce nastawne	118
Insulated flat nose pliers Klucze płaskie izolowane	118

Insulated open end wrenches Klucze płaskie izolowane		118
--	--	-----

Insulated T-handle wrenches Rękojeści typu „T” z zabierakiem izolowane		118
--	---	-----

Insulated adjustable wrenches Klucze nastawne izolowane		118
---	---	-----

Insulated sockets & accessories Klucze nasadowe izolowane i akcesoria		118
---	---	-----

Insulated ratchet handles 1/2” Grzechotki izolowane 1/2”	118
--	-----

Insulated clamps Ściski izolowane		118
---	---	-----

Crimping pliers & sets Szczypce do zaciskania konektorów i zestawy		119-121
--	---	---------

Hydraulic pliers & accessories Ręczne praski hydrauliczne i akcesoria		121
---	---	-----

Wire strippers Ściągacze izolacji		122-123
---	---	---------

Electrical cutters Obcinaki elektryczne		124-125
---	---	---------

Cable cutters Nożyce do kabli		125-127
---	---	---------

Electric meters & voltage testers Mierniki elektryczne i próbniki napięcia		127-128
--	---	---------

Multimeters Mierniki		128-131
--------------------------------	--	---------

Tweezers Pęsety		132
---------------------------	---	-----

Tapes & sets Taśmy i zestawy		132-133
--	---	---------

Tool sets Zestawy narzędziowe		133
---	---	-----

Cable access & accessories Przepychacze przewodów i akcesoria		133
---	---	-----

EN Insulated screwdriver
 PL Wkrętak izolowany
 DE Isolierte Schraubendreher

RU Изолированная отвёртка
 CZ Izolovaný šroubovák
 HU Szigetelt csavarhúzó

RO Şurubelniţă izolată
 FR Tournevis isolé
 IT Cacciavite isolato

ES Destornillador aislado
 CN 一字绝缘螺丝批

HRC 56-60 S2 1000 V



YATO	⊖ [mm]	L [mm]	📦
YT-28150	2.5	75	12/360
YT-28153	3.0	100	12/360
YT-28174	3.5	100	12/360
YT-2817	4.0	100	12/120
YT-2818	5.5	125	12/120
YT-2819	6.5	150	12/120
YT-2820	8.0	175	12/120

YATO	⊕	L [mm]	📦
YT-2821	PH0	60	12/120
YT-2822	PH1	80	12/120
YT-2823	PH2	100	12/120
YT-2824	PH3	150	12/120

YATO	⊕	L [mm]	📦
YT-28245	PZ0	60	12/360
YT-2825	PZ1	80	12/120
YT-2826	PZ2	100	12/120
YT-28263	PZ3	150	12/96

EN Insulated screwdriver set
 PL Komplet wkrętek izolowanych
 DE Isolierte Schraubendrehersatz

RU Изолированная отвёртка - набор
 CZ Izolované šroubováky
 HU Szigetelt csavarhúzó

RO Şurubelniţă izolată
 FR Set de tournevis isolés
 IT Set di cacciavite isolato

ES Juego de destornilladores aislado
 CN 绝缘螺丝批组套

HRC 56-60 S2 1000 V

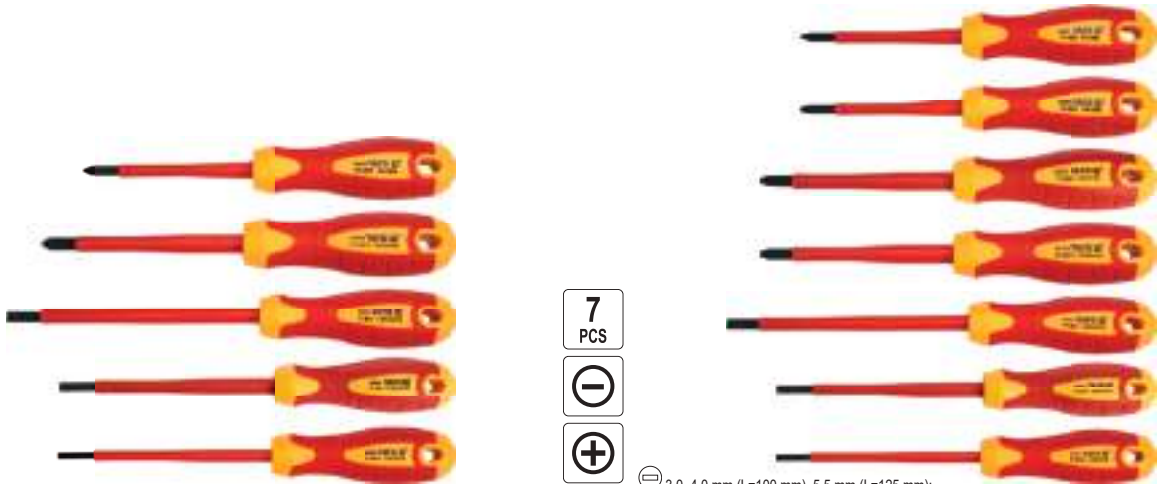

5 PCS

7 PCS



⊖ 3.0, 4.0 mm (L=100 mm), 5.5 mm (L=125 mm);
 ⊕ PH1 (L=80 mm), PH2 (L=100 mm)

⊖ 3.0, 4.0 mm (L=100 mm), 5.5 mm (L=125 mm);
 ⊕ PH1 (L=80 mm), PH2 (L=100 mm);
 ⚙ PZ1 (L=80 mm), PZ2 (L=100 mm)

YATO	📦
YT-2827	10/40

YATO	📦
YT-2828	10/40

EN Insulated changeable screwdriver set
 PL Zestaw wkrętek z wymiennymi końcówkami izolowanymi
 DE Isolierte Schraubendrehersatz
 RU Набор изолированных отвёрток
 CZ Sada izolovaných šroubováků
 HU Szigetelt csavarhúzó készlet
 RO Set surubelnita cu biti izolate
 FR Jeu de tournevis isolés
 IT Set cacciaviti isolati
 ES Juego de destornilladores aislado
 CN 绝缘可换头螺丝批组套

12 PCS

HRC 54-61

S2 1000 V



EN Insulated changeable screwdriver set
 PL Zestaw wkrętek z wymiennymi końcówkami izolowanymi
 DE Isolierte Schraubendrehersatz
 RU Набор изолированных отвёрток
 CZ Sada izolovaných šroubováků
 HU Szigetelt csavarhúzó készlet

RO Set surubelnita cu biti izolate
 FR Jeu de tournevis isolés
 IT Set cacciaviti isolati
 ES Juego de destornilladores aislado
 CN 绝缘可换头螺丝批组套

50 PCS

HRC 54-61

S2 1000 V



⊖ 2.0, 2.5, 3.0, 3.5, 4.0, 5.5, 6.5 mm (L=100 mm); S2;
 ⊕ PH0, PH1, PH2 (L=100 mm); S2;
 4x150 mm; 250 V

1000 V
 VDE CERTIFICATE
 EN 60900:2012

YATO	📦
YT-28290	24

⊖ 2.0, 2.5, 3.0, 3.5, 4.0, 5.5, 6.5 mm (L=100 mm); S2;
 ⊕ PH0, PH1, PH2 (L=100 mm); S2;
 ⚙ PZ0, PZ1, PZ2 (L=100 mm); S2;
 T6, T8, T9, T10, T15, T20, T25, T27, T30 (L=100 mm); S2;
 2.5, 3, 4, 5, 6 mm (L=100 mm); S2;
 R1, R2 (L=100 mm); S2;

⊖ 1, 2, 3, 4 mm (L=100 mm); S2;
 ⊕ 4, 6, 8, 10 mm (L=100 mm); S2;
 ⊕ 4, 6, 8, 10 mm (L=100 mm); S2;
 M4, M5, M6 (L=100 mm); S2;
 4x150 mm; 250 V

HRC 54-61

S2 1000 V



1000 V
 VDE CERTIFICATE
 EN 60900:2012

YATO	📦
YT-28293	10

EN Insulated screwdriver set
PL Komplet wkrętek izolowanych
DE Isolierte Schraubendrehersatz
RU Набор изолированных отверток
CZ Izolované šroubováky
HU Szigetelt csavarhúzó készlet
RO Set surubelnita izolata
FR Jeu de tournevis isolés
IT Set cacciaviti isolati
ES Juego de destornilladores aislado
CN 绝缘螺丝批组套



⊖ 1.8, 2.0 mm (L=50 mm), 2.5, 3.0 mm (L=65 mm); S2;
⊕ PH00, PH0 (L=65 mm); S2

YATO		
YT-28283		6/48

EN Insulated changeable screwdriver set
PL Zestaw wkrętek z wymiennymi końcówkami izolowanymi
DE Isolierte Schraubendrehersatz
RU Набор изолированных отверток
CZ Sada izolovaných šroubováků
HU Szigetelt csavarhúzó készlet
RO Set surubelnita cu biti izolate
FR Jeu de tournevis isolés
IT Set cacciaviti isolati
ES Juego de destornilladores aislado
CN 绝缘可换头螺丝批组套

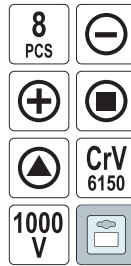

⊖ 3.0, 4.0, 5.5 mm (L=100 mm); CrV 6150;
⊕ PH1 (L=80 mm), PH2 (L=100 mm); CrV 6150;
⊗ Square lock key / Klucz kwadratowy;
⊘ Triangle lock key / Klucz trójkątny

YATO		
YT-28294		6/24

EN Insulated changeable screwdriver set
PL Zestaw wkrętek z wymiennymi końcówkami izolowanymi
DE Isolierte Schraubendrehersatz
RU Набор изолированных отверток
CZ Sada izolovaných šroubováků
HU Szigetelt csavarhúzó készlet
RO Set surubelnita cu biti izolate
FR Jeu de tournevis isolés
IT Set cacciaviti isolati
ES Juego de destornilladores aislado
CN 绝缘可换头螺丝批组套

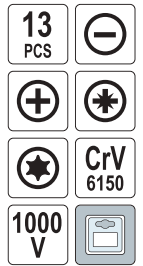

⊖ 3.0, 4.0, 5.5, 6.5 mm (L=100 mm); CrV 6150;
⊕ PH1 (L=80 mm), PH2 (L=100 mm); CrV 6150;
⊗ PZ1 (L=80 mm), PZ2 (L=100 mm); CrV 6150;
⊘ T10, T15, T20 (L=100 mm); CrV 6150;
⊘ 3x140 mm; 250 V

YATO		
YT-28295		6/12

EN Combination pliers
PL Szczypce uniwersalne
DE Kombinationszange
RU Плоскогубцы универсальные
CZ Kleště kombinované
HU Kombináltfogó
RO Patent universal
FR Pince universelle
IT Pinze universali
ES Alicates universales
CN 绝缘钢丝钳



1000 V
VDE CERTIFICATE
EN 60900:2012

YATO	L [mm]	
YT-21151	160	6/36
YT-21152	180	6/36
YT-21153	200	6/36

EN Long nose pliers
PL Szczypce wydłużone proste
DE Radiozange
RU Тонкогубцы прямые
CZ Prodloužené kleště rovné
HU Rádiófogó, egyenes
RO Clește cu vârf ascuțit
FR Pince prolongée
IT Pinze lunghe diritte
ES Alicates de punta
CN 绝缘尖嘴钳



1000 V
VDE CERTIFICATE
EN 60900:2012

YATO	L [mm]	
YT-21154	160	6/36
YT-21155	200	6/36

EN Diagonal side cutting pliers
PL Szczypce tnące boczne
DE Seitenschneider
RU Бокорезы
CZ Řezací kleště boční
HU Oldal csípőfogó
RO Olește tăietor
FR Pince à coupe latérale
IT Pinze taglianti laterali
ES Alicates corte lateral
CN 绝缘斜嘴钳



1000 V
VDE CERTIFICATE
EN 60900:2012

YATO	L [mm]	
YT-21158	160	6/36
YT-21159	180	6/36

EN Insulated wire stripper
PL Szczypce do ściągania izolacji, izolowane
DE Abisolier-Zange, isoliert
RU Изолированные клещи для снятия изоляции
CZ Kleště pro stahování izolace, izolované
HU Szigetelés lehúzó fogó, szigetelt
RO Decablator VDE
FR Pince à dénuder isolée
IT Pinza spelafili isolata
ES Alicates para quitar aislamiento, aislados
CN 绝缘剥线钳

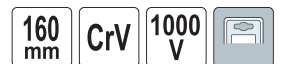

1000 V
VDE CERTIFICATE
EN 60900:2012

YATO	L [mm]	
YT-21160	160	6/36

EN Insulated water pump pliers
 PL Szczypce nastawne hydrauliczne, izolowane
 DE Hydraulik-Rohrzange, isoliert
 RU Изолированные переставные клещи
 CZ Nastavitelné kleště izolované
 HU Vízpumpa fogó szigetelt
 RO Cleste papagal VDE
 FR Pince réglable multiprises isolée
 IT Pinza regolabile isolata per idraulici
 ES Alicates hidráulicos ajustables, aislados
 CN 绝缘水泵钳

250 mm CrV 1000 V



1000 V
 VDE CERTIFICATE
 EN 60900:2012

YATO	L [mm]	
YT-21161	250	6/24

EN Insulated flat nose pliers
 PL Szczypce płaskie izolowane
 DE Greifzange vollisoliert
 RU Плоскогубцы изолированные
 CZ Izolované kleště ploché
 HU Laposfogó szigetelt
 RO Patent izolat
 FR Pince plate isolée
 IT Pinza piatta isolata
 ES Alicates punta plana aislantes
 CN 绝缘塑料圆头线夹

200 mm CrV 1000 V



1000 V
 VDE CERTIFICATE
 EN 60900:2012

YATO	L [mm]	
YT-21191	200	6/48

EN Insulated open end wrench
 PL Klucz płaski izolowany
 DE Doppelmaulschlüssel isoliert
 RU Ключ рожковый односторонний изолированный
 CZ Otevřený klíč izolovaný
 HU Villáskulcs
 RO Cheie fixă izolată
 FR Clé plate isolée
 IT Chiave piatta isolato
 ES Llave fija aislante
 CN 双色柄绝缘开口扳手



1000 V
 VDE CERTIFICATE
 EN 60900:2012

YATO	Ø [mm]	L [mm]	B [mm]	S [mm]	
YT-20954	10	110	31	8.0	6/108
YT-20957	13	135	39	10.5	6/72

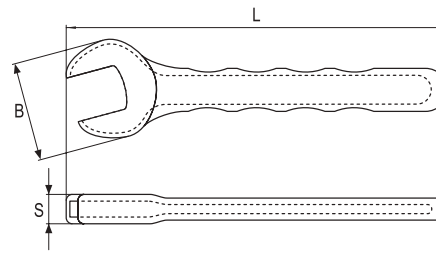

CrV 1000 V

YATO	Ø [mm]	L [mm]	B [mm]	S [mm]	
YT-20961	17	160	47	12.5	6/72
YT-20963	19	175	53	14.0	6/72

EN Insulated T-handle wrench
 PL Rękojeść typu „T” izolowana
 DE Steckschlüssel T-griff vollisoliert
 RU Ручка Т-образная изолированная
 CZ Klíč nástrčný typ „T” izolovaný
 HU „T” típusú dugókulcs
 RO Manerit tip „T” izolat
 FR Clé à tube en „T” isolée
 IT Chiave a bussola tipo „T” isolati
 ES Llave en T aislada
 CN 绝缘T型套筒扳手



1000 V
 VDE CERTIFICATE
 EN 60900:2012

EN Insulated adjustable wrench
 PL Klucz nastawny izolowany
 DE Rollgabelschlüssel isoliert
 RU Ключ разводной изолированный
 CZ Izolovaný stavitelný klíč
 HU Állítható svédkulcs
 RO Cheie reglabilă izolată
 FR Clé à molette isolée
 IT Isolati chiave regolabile
 ES Llave ajustable aislante
 CN 双色柄绝缘活络扳手

CrV 1000 V



1000 V
 VDE CERTIFICATE
 EN 60900:2012

YATO	L [mm]	
YT-20940	200	6/48

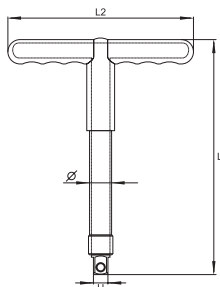

3/8" 9.5 mm 1/2" 12.7 mm CrV 1000 V

YATO	Ø H	L1 [mm]	L2 [mm]	Ø [mm]	
YT-21095	3/8" (9.5 mm)	207	160	15.6	4/32
YT-21096	1/2" (12.7 mm)	207	160	19.3	4/32

EN Insulated ratchet handle
 PL Grzechotka izolowana
 DE Hebelumschaltknarre vollisoliert
 RU Трещотка диэлектрическая
 CZ Ráčna izolovaná
 HU Racsnis hajtókar
 RO Antrenor cu clichet izolat
 FR Clé à cliquet isolée
 IT Cricchetto bussola isolato
 ES Carraca aislante
 CN 双色柄绝缘双向棘轮扳手

1/2" 12.7 mm CrV 1000 V



1000 V
 VDE CERTIFICATE
 EN 60900:2012

YATO	Ø	T	L [mm]	
YT-21072	1/2" (12.7 mm)	36	250	6/36

EN Insulated spring clamp
 PL Ścisk sprężynowy izolowany
 DE Federklemme vollisoliert
 RU Струцизна изолированная
 CZ Pružinová svěrka
 HU Rugós szorító
 RO Cleste presa pt. lemni izolat
 FR Pince à ressort isolée
 IT Morsetto a molla isolato
 ES Pinza aislante
 CN 绝缘塑料圆头线夹



150 mm CrV 1000 V

1000 V
 VDE CERTIFICATE
 EN 60900:2012

YATO	Working capacity / Zakres pracy [mm]	L [mm]	
YT-21190	2-20	150	5/40

EN Quick interchangeable ratchet crimper set
PL Zestaw do zaciskania konektorów
DE Kabelschuhzange
RU Клещи для опрессовки наконечников
CZ Kleště pro svěrání zaciskania konektorů
HU Krimpelő fogó
RO Clește sertizat conectori
FR Pince à sertir pour connecteurs
IT Set pinze per crimpare a connettori
ES Pinzas de apretar de conectores
CN 棘轮压线钳组套

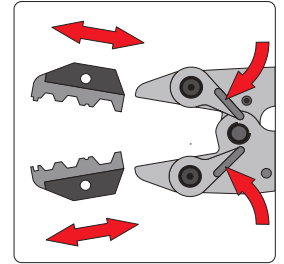
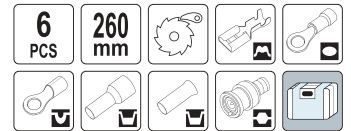

mm ²	AWG	mm ²	AWG	mm ²	AWG	mm ²	AWG	
0.5-6.0	20~10	0.5-6.0	22~10	1.5-10.0	20~8	0.5-4.0	22~12	RG6, RG58, RG59, RG62

YATO	YT-245	
		10

EN Ratchet crimping pliers
PL Szczypce do zaciskania konektorów
DE Kabelschuhzange
RU Клещи для опрессовки наконечников
CZ Kleště pro svěrání zaciskania konektorů
HU Krimpelő fogó

RO Clește sertizat conectori
FR Pince pour serrer les connecteurs
IT Pinza per crimpare a connettori
ES Pinzas de apretar de conectores
CN 棘轮压线钳

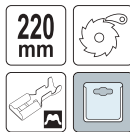

YATO	mm ²	AWG	
YT-2250	0.5-6	20~10	5/30

EN Ratchet crimping pliers
PL Szczypce do zaciskania konektorów
DE Kabelschuhzange
RU Клещи для опрессовки наконечников
CZ Kleště pro svěrání zaciskania konektorů
HU Krimpelő fogó

RO Clește sertizat conectori
FR Pince pour serrer les connecteurs
IT Pinza per crimpare a connettori
ES Pinzas de apretar de conectores
CN 压线钳



YATO	mm ²	AWG	mm ²	AWG	
YT-2255	0.08-2	28~14	0.12-0.3	26~22	12/72

EN Ratchet crimping pliers
PL Szczypce do zaciskania konektorów
DE Kabelschuhzange
RU Клещи для опрессовки наконечников
CZ Kleště pro svěrání zaciskania konektorů
HU Krimpelő fogó

RO Clește sertizat conectori
FR Pince pour serrer les connecteurs
IT Pinza per crimpare a connettori
ES Pinzas de apretar de conectores
CN 棘轮压线钳



YATO	mm ²	AWG	
YT-2296	0.5-6	22~10	5/30

EN Ratchet crimping pliers
PL Szczypce do zaciskania konektorów
DE Kabelschuhzange
RU Клещи для опрессовки наконечников
CZ Kleště pro svěrání zaciskania konektorů
HU Krimpelő fogó

RO Clește sertizat conectori
FR Pince pour serrer les connecteurs
IT Pinza per crimpare a connettori
ES Pinzas de apretar de conectores
CN 棘轮压线钳



YATO	mm ²	AWG	
YT-2300	0.5-6	20~10	5/30

EN Ratchet crimping pliers
PL Szczypce do zaciskania konektorów
DE Kabelschuhzange
RU Клещи для опрессовки наконечников
CZ Kleště pro svěrání zaciskania konektorů
HU Krimpelő fogó

RO Clește sertizat conectori
FR Pince pour serrer les connecteurs
IT Pinza per crimpare a connettori
ES Pinzas de apretar de conectores
CN 压线钳

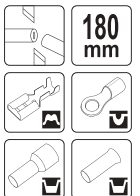

YATO	mm ²	AWG	mm ²	AWG	mm ²	AWG	
YT-2256	0.08-2	28~14	0.3-6	22~10	0.12-0.3	26~22	12/72

EN Ratchet crimping pliers
PL Szczypce do zaciskania konektorów
DE Kabelschuhzange
RU Клещи для опрессовки наконечников
CZ Kleště pro svěrání zaciskania konektorů
HU Krimpelő fogó

RO Clește sertizat conectori
FR Pince pour serrer les connecteurs
IT Pinza per crimpare a connettori
ES Pinzas de apretar de conectores
CN 棘轮压线钳



YATO	mm ²	AWG	
YT-2246	0.5-6	22~10	5/30

EN Ratchet crimping pliers
 PL Szczypce do zaciskania konektorów
 DE Kabelschuhzange
 RU Клещи для опрессовки наконечников
 CZ Kleště pro svěrání zaciskania konektorů
 HU Krimpelő fogó

RO Clește sertizat conectori
 FR Pince pour serrer les connecteurs
 IT Pinza per crimpare a connettori
 ES Pinzas de apretar de conectores
 CN 棘轮压线钳



YATO		
YT-2298	RG6, RG58, RG59, RG62	5/30

EN Ratchet crimping pliers
 PL Szczypce do zaciskania konektorów
 DE Kabelschuhzange
 RU Клещи для опрессовки наконечников
 CZ Kleště pro svěrání zaciskania konektorů
 HU Krimpelő fogó

RO Clește sertizat conectori
 FR Pince pour serrer les connecteurs
 IT Pinza per crimpare a connettori
 ES Pinzas de apretar de conectores
 CN 棘轮压线钳



YATO		
YT-2247	1.5-10	20-8

EN Ratchet crimping pliers
 PL Szczypce do zaciskania konektorów
 DE Kabelschuhzange
 RU Клещи для опрессовки наконечников
 CZ Kleště pro svěrání zaciskania konektorů
 HU Krimpelő fogó

RO Clește sertizat conectori
 FR Pince pour serrer les connecteurs
 IT Pinza per crimpare a connettori
 ES Pinzas de apretar de conectores
 CN 棘轮压线钳



YATO		
YT-2297	1.5-10	20-8

EN Cable lug crimping pliers
 PL Praska mechaniczna do końcówek kablowych
 DE Crimpzange für Kabelschuhe
 RU Механический ручной пресс для наконечников
 CZ Krimpovací kleště na kabelová oka
 HU Mechanikus kábeláru prés

RO Clește pt. sertizare cabluri
 FR Pince à sertir les cosses de câble
 IT Pinza crimpatrice manuale
 ES Prensa mecánica para terminales de cables
 CN 压线钳



YATO		
YT-22857	6, 10, 16, 25, 35, 50	10

EN Ratchet crimping pliers
 PL Szczypce do zaciskania konektorów
 DE Kabelschuhzange
 RU Клещи для опрессовки наконечников
 CZ Kleště pro svěrání zaciskania konektorů
 HU Krimpelő fogó

RO Clește sertizat conectori
 FR Pince pour serrer les connecteurs
 IT Pinza per crimpare a connettori
 ES Pinzas de apretar de conectores
 CN 棘轮压线钳



YATO		
YT-2299	0.5-4	22-12

EN Ratchet crimping pliers
 PL Szczypce do zaciskania konektorów
 DE Kabelschuhzange
 RU Клещи для опрессовки наконечников
 CZ Kleště pro svěrání zaciskania konektorů
 HU Krimpelő fogó

RO Clește sertizat conectori
 FR Pince pour serrer les connecteurs
 IT Pinza per crimpare a connettori
 ES Pinzas de apretar de conectores
 CN 压线钳



YATO		
YT-23001	6, 10, 16	10, 8, 6

EN Ratchet crimping pliers
 PL Szczypce do zaciskania konektorów
 DE Kabelschuhzange
 RU Клещи для опрессовки наконечников
 CZ Kleště pro svěrání zaciskania konektorů
 HU Krimpelő fogó
 RO Clește sertizat conectori
 FR Pince pour serrer les connecteurs
 IT Pinza per crimpare a connettori
 ES Pinzas de apretar de conectores
 CN 管型端子压接钳组套

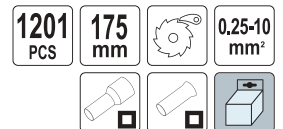

0.5 mm² x 8 mm (250 PCS), 0.75 mm² x 8 mm (210 PCS), 1.0 mm² x 8 mm (200 PCS), 1.5 mm² x 8 mm (240 PCS), 2.5 mm² x 8 mm (215 PCS), 4.0 mm² x 9 mm (40 PCS), 6.0 mm² x 12 mm (30 PCS), 10.0 mm² x 12 mm (15 PCS)

YATO		
YT-23052	0.25-10	12

EN Ratchet crimping pliers
PL Szczypce do zaciskania konektorów
DE Kabelschuhzange
RU Клещи для опрессовки наконечников
CZ Kleště pro svěrání zaciskania konektorů
HU Krimpelő fogó

RO Clește sertizat conectori
FR Pince pour serrer les connecteurs
IT Pinza per crimpare a connettori
ES Pinzas de apretar de conectores
CN 棘轮压线钳

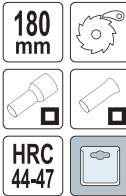

YATO	[mm ²]	
YT-2240	0.2-6	6/36

EN Ratchet crimping pliers
PL Szczypce do zaciskania konektorów
DE Kabelschuhzange
RU Клещи для опрессовки наконечников
CZ Kleště pro svěrání zaciskania konektorů
HU Krimpelő fogó

RO Clește sertizat conectori
FR Pince pour serrer les connecteurs
IT Pinza per crimpare a connettori
ES Pinzas de apretar de conectores
CN 棘轮压线钳

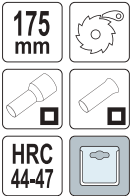

YATO	[mm ²]	
YT-2305	0.2-6	6/36

EN Ratchet crimping pliers
PL Szczypce do zaciskania konektorów
DE Kabelschuhzange
RU Клещи для опрессовки наконечников
CZ Kleště pro svěrání zaciskania konektorů
HU Krimpelő fogó

RO Clește sertizat conectori
FR Pince pour serrer les connecteurs
IT Pinza per crimpare a connettori
ES Pinzas de apretar de conectores
CN 棘轮压线钳

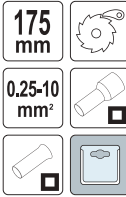

YATO	[mm ²]	
YT-23051	0.25-10	10/40

EN Ratchet crimping pliers
PL Szczypce do zaciskania konektorów
DE Kabelschuhzange
RU Клещи для опрессовки наконечников
CZ Kleště pro svěrání zaciskania konektorů
HU Krimpelő fogó

RO Clește sertizat conectori
FR Pince pour serrer les connecteurs
IT Pinza per crimpare a connettori
ES Pinzas de apretar de conectores
CN 压线钳

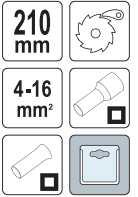

YATO	[mm ²]	
YT-23054	4-16	10/30

EN Ratchet crimping pliers
PL Szczypce do zaciskania konektorów
DE Kabelschuhzange
RU Клещи для опрессовки наконечников
CZ Kleště pro svěrání zaciskania konektorů
HU Krimpelő fogó

RO Clește sertizat conectori
FR Pince pour serrer les connecteurs
IT Pinza per crimpare a connettori
ES Pinzas de apretar de conectores
CN 棘轮压线钳



YATO		
YT-22442	RJ45, RJ11, 8P, 6P	10/50

EN Ratchet crimping pliers
PL Szczypce do zaciskania konektorów
DE Kabelschuhzange
RU Клещи для опрессовки наконечников
CZ Kleště pro svěrání zaciskania konektorů
HU Krimpelő fogó

RO Clește sertizat conectori
FR Pince pour serrer les connecteurs
IT Pinza per crimpare a connettori
ES Pinzas de apretar de conectores
CN 网络压线钳

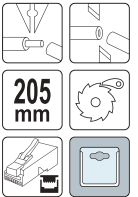

YATO		
YT-22443	RJ45, RJ11, RJ10, 8P, 6P, 4P	10/30

EN Hydraulic crimping tool
PL Ręczna praska hydrauliczna
DE Manuelle Hydraulikpresse
RU Ручной гидравлический пресс
CZ Ruční hydraulický lis
HU Kézi hydraulikus prés

RO Presă hidraulică manuală
FR Pince à sertir hydraulique
IT Pressa idraulica manuale
ES Prensa hidráulica manual
CN 液压钳



YATO	[mm ²]	L [mm]	Force pressure / Sita nacisku [t]	Al [mm ²]	Cu [mm ²]	
YT-22860	10, 16, 25, 35, 50, 70, 95, 120	415	8	10-95	10-120	4
YT-22861	16, 25, 35, 50, 70, 95, 120, 150, 185, 240	470	12	16-185	16-240	3
YT-22862	16, 25, 35, 50, 70, 95, 120, 150, 185, 240, 300	470	18-20	16-240	16-300	3

EN Spare dies for crimping tool
PL Wymienne matryce do praski
DE Ersatz-Matrizen für manuelle Hydraulikpresse
RU Набор матриц для ручного гидравлического пресса
CZ Výměnitelné matrice pro ruční hydraulický lis
HU Cserélhető présfej
RO Capete sertizat pt. presa hidraulica
FR Jeux de mâchoires pour pince à sertir hydraulique
IT Matrici sostituibili per pressa idraulica manuale
ES Matrices de recambio para prensa
CN 液压压接钳备用压接头

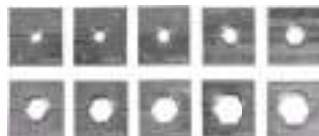

YATO	[mm ²]	pcs / szt.	For / Dla	
YT-22863	10, 16, 25, 35, 50, 70, 95, 120	8	YT-22860	10
YT-22864	16, 25, 35, 50, 70, 95, 120, 150, 185, 240	10	YT-22861	10
YT-22865	16, 25, 35, 50, 70, 95, 120, 150, 185, 240, 300	11	YT-22862	10

EN Pliers for crimping lines
 PL Szczypce do zaciskania lin stalowych
 DE Zangen für Crimp-Linien
 RU Клещи для опрессовки каблатов
 CZ Ruční lisovací kleště
 HU Krimpelő fogó

RO Cleste pt. sertizat cabluri
 FR Pincés pour lignes de sertissage
 IT Pinze per crimpare cavi metallici
 ES Alicates para líneas de engaste
 CN 多功能压接钳

600 mm

DROP FORGED KUTE







YATO	Ø [mm]	L [mm]	
YT-22851	4.8, 6.6, 8.7, 9.5, 11.3	600	6

EN Multifunctional pliers
 PL Szczypce wielofunkcyjne
 DE Multifunktionszange
 RU Клещи многофункциональные
 CZ Multifunkční kleště
 HU Multifunkciós fogó

RO Cleste multifunctional pt. sertizat
 FR Pince multifonction
 IT Pinze multifunzione
 ES Alicates multifuncionales
 CN 多功能剥线钳

5 in 1
5 w 1







240 mm

M2.6-M5



HRC 46-50





YATO	 mm2	 AWG	 mm2	 AWG	 mm2	 AWG	
YT-22930	1.5-6	22-10	1.5-6	22-10	0.75-6	22-10	12/48

EN Wire stripper
 PL Ściągacz izolacji
 DE Abisolierzange
 RU Съёмник изоляции
 CZ Odizolovací klejte
 HU Blankolo fogó

RO Decablator
 FR Extracteur d'isolation
 IT Pinze per scaricare isolamento
 ES Extractor de aislado
 CN 剥线钳

160 mm



HRC 48-52







YATO	 mm2	 AWG	
YT-2319	0.8-2.6	20-10	10/60

EN Universal wire stripper
 PL Uniwersalny ściągacz izolacji
 DE Universal Abisolierzange
 RU Универсальный съёмник изоляции
 CZ Univerzální odizolovací kleště
 HU Blankolo fogó
 RO Decablator universal
 FR Extracteur d'isolation multifonction
 IT Pinze per scaricare isolamento
 ES Extractor de aislado universal
 CN 万用剥线钳





191 PCS

205 mm







0.2-6.0 mm²

Cr12MoV

TPR PP



-  0.5 - 1.5 mm² (20 PCS), 1.5 - 2.5 mm² (20 PCS);
-  0.5 - 1.5 mm² (20 PCS), 1.5 - 2.5 mm² (20 PCS);
-  0.5 - 1.5 mm² (20 PCS), 1.5 - 2.5 mm² (20 PCS);
-  0.5 - 1.5 mm² (20 PCS), 1.5 - 2.5 mm² (20 PCS);
-  0.5 - 1.5 mm² (10 PCS), 1.5 - 2.5 mm² (10 PCS);
-  0.5 - 1.5 mm² (10 PCS)

YATO	 mm2	 AWG	 mm2	 AWG	 mm2	 AWG	 mm2	 AWG	
YT-23133	0.5-6	22-10	0.5-6	22-10	0.5-6	22-10	0.2-6	24-10	10/20

EN Universal wire stripper & ratchet crimping pliers
PL Uniwersalny ściągacz izolacji i szczytce do zaciskania konektorów
DE Multifunktion Abisolierzange & Kabelschuhklemmzange
RU Инструмент для снятия изоляции и зажима проводов
CZ Kleště odizolovací a konektorové univerzální
HU Blankoló fogo & krimpelő fogó
RO Decablator universal & clește sertizat conectori
FR Extracteur d'isolation multifonction
IT Pinze per scaricare isolamento
ES Extractor de aislado multifunción
CN 万用剥线钳



YATO					
YT-22703	0.2-6	24~10	0.2-6	24~10	10/40

EN Universal wire stripper & ratchet crimping pliers
PL Uniwersalny ściągacz izolacji i szczytce do zaciskania konektorów
DE Multifunktion Abisolierzange & Kabelschuhklemmzange
RU Инструмент для снятия изоляции и зажима проводов
CZ Kleště odizolovací a konektorové univerzální
HU Blankoló fogo & krimpelő fogó
RO Decablator universal & clește sertizat conectori
FR Extracteur d'isolation multifonction
IT Pinze per scaricare isolamento
ES Extractor de aislado multifunción
CN 万用剥线钳



YATO							
YT-2270	0.5-6	22~10	1.5-6	22~10	0.2-6	24~10	5/30

EN Universal wire stripper & ratchet crimping pliers
PL Uniwersalny ściągacz izolacji i szczytce do zaciskania konektorów
DE Multifunktion Abisolierzange & Kabelschuhklemmzange
RU Инструмент для снятия изоляции и зажима проводов
CZ Kleště odizolovací a konektorové univerzální
HU Blankoló fogo & krimpelő fogó
RO Decablator universal & clește sertizat conectori
FR Extracteur d'isolation multifonction
IT Pinze per scaricare isolamento
ES Extractor de aislado multifunción
CN 万用剥线钳

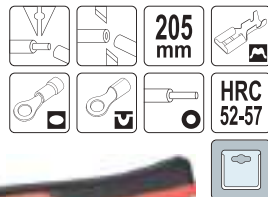

YATO							
YT-2313	0.5-6	22~10	1.5-6	22~10	0.2-6	24~10	5/30

EN Universal wire stripper & ratchet crimping pliers
PL Uniwersalny ściągacz izolacji i szczytce do zaciskania konektorów
DE Multifunktion Abisolierzange & Kabelschuhklemmzange
RU Инструмент для снятия изоляции и зажима проводов
CZ Kleště odizolovací a konektorové univerzální
HU Blankoló fogo & krimpelő fogó
RO Decablator universal & clește sertizat conectori
FR Extracteur d'isolation multifonction
IT Pinze per scaricare isolamento
ES Extractor de aislado multifunción
CN 剥线钳



YATO					
YT-2278	0.5-6	22~10	0.2-6	24~10	10/60

EN Automatic wire stripper
PL Automatyyczny ściągacz izolacji
DE Automatische Abisolierzange
RU Клещи для удаления изоляции
CZ Automatický stahovač izolace
HU Automatikus szigeteléslehúzó

RO Clește automat desizolat
FR Extracteur d'isolation automatique
IT Pinze per scaricare isolamento
ES Pelacables automatico
CN 万用剥线钳



YATO			
YT-2268	0.5-6	20~10	10/60

EN Wire stripper
PL Ściągacz izolacji
DE Abisolierzange
RU Съёмник изоляции
CZ Odizolovací klejste
HU Blankoló fogo

RO Decablator
FR Extracteur d'isolation
IT Pinze per scaricare isolamento
ES Extractor de aislado
CN 剥线钳

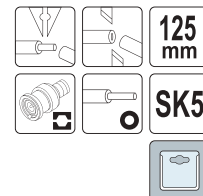

YATO			
YT-2274	RG9, RG59	0.5-6	20~10

EN Automatic wire stripper
PL Automatyyczny ściągacz izolacji
DE Automatische Abisolierzange
RU Клещи для удаления изоляции
CZ Automatický stahovač izolace
HU Automatikus szigeteléslehúzó

RO Clește automat desizolat
FR Extracteur d'isolation automatique
IT Pinze per scaricare isolamento
ES Pelacables automatico
CN 自动剥线钳



YATO			
YT-2275	0.5-6	20~10	10/60

EN Wire stripper
PL Ściągacz izolacji
DE Abisolierzange
RU Съёмник изоляции
CZ Odizolovací klejste
HU Blankoló fogo
RO Decablator
FR Extracteur d'isolation
IT Pinze per scaricare isolamento
ES Extractor de aislado
CN 万用剥线钳



YATO			
YT-22753	0.03-10	32~8	10/40

EN Electrical cutter
 PL Obcinak elektryczny
 DE Seitenschneider
 RU Инструмент для обрезки проводов
 CZ Elektrické upichováky
 HU Kábelvágó
 RO Clește tăietor - electrician
 FR Coupeur isolé
 IT Pinza per elettronica
 ES Cortacables eléctricos
 CN 电子斜嘴钳



YATO	max. Ø [mm]	mm ²	AWG	L [mm]	
YT-2260	3	0.14-0.34	26~22	125	15/150

EN Electrical cutter
 PL Obcinak elektryczny
 DE Seitenschneider
 RU Инструмент для обрезки проводов
 CZ Elektrické upichováky
 HU Kábelvágó
 RO Clește tăietor - electrician
 FR Coupeur isolé
 IT Pinza per elettronica
 ES Cortacables eléctricos
 CN 电子斜嘴钳



YATO	max. Ø [mm]	L [mm]	
YT-2261	3	125	15/150

EN Automatic wire stripper
 PL Automacyjny ściągacz izolacji
 DE Automatische Abisolierzange
 RU Клещи для удаления изоляции
 CZ Automatický stahovač izolace
 HU Automatikus szigeteléslehúzó

RO Clește automat desizolat
 FR Extracteur d'isolation automatique
 IT Pinze per scaricare isolamento
 ES Pelacables automatico
 CN 自动剥线钳

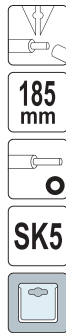

YATO	mm ²	AWG	
YT-2316	1-3.2	18~12	8/48

EN Electrical cutter
 PL Obcinak elektryczny
 DE Seitenschneider
 RU Инструмент для обрезки проводов
 CZ Elektrické upichováky
 HU Kábelvágó
 RO Clește tăietor - electrician
 FR Coupeur isolé
 IT Pinza per elettronica
 ES Cortacables eléctricos
 CN 电子斜嘴钳

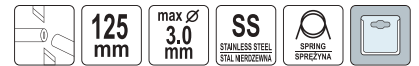

YATO	max. Ø [mm]	L [mm]	
YT-2262	3	125	20/120

EN Electrical cutter
 PL Obcinak elektryczny
 DE Seitenschneider
 RU Инструмент для обрезки проводов
 CZ Elektrické upichováky ze stahovadlem
 HU Kábelvágó szigeteléslehúzóval
 RO Clește tăietor - electrician
 FR Coupeur isolé
 IT Pinza per elettronica
 ES Cortacables eléctricos
 CN 电子斜嘴钳



YATO	mm ²	AWG	L [mm]	
YT-22640	0.8-2.6	20~10	140	20/120

EN Electrical cutter
 PL Obcinak elektryczny
 DE Seitenschneider
 RU Инструмент для обрезки проводов
 CZ Elektrické upichováky
 HU Kábelvágó
 RO Clește tăietor - electrician
 FR Coupeur isolé
 IT Pinza per elettronica
 ES Cortacables eléctricos
 CN 迷你电子钳



YATO	max. Ø [mm]	L [mm]	
YT-2263	3	130	12/120

EN Cable cutter
 PL Szczypce do cięcia przewodów
 DE Kabelschere
 RU Кабелперезы
 CZ Štípačí kleště na kabely
 HU Kábelvágó
 RO Clește tăiat cabluri
 FR Pince à couper les fils
 IT Cesovia per cavi elettrici
 ES Alicates cortacables
 CN 电缆剪



YATO	max. Ø [mm]	L [mm]	
YT-19682	10.5	200	10/100

EN Cable cutter
 PL Szczypce do cięcia przewodów
 DE Kabelschere
 RU Кабелперезы
 CZ Štípačí kleště na kabely
 HU Kábelvágó

RO Patent tăietor pt. electrice
 FR Pince pour câbles
 IT Cesovia per cavi elettrici
 ES Alicates cortacables
 CN 电缆断线钳



YATO	max. Ø [mm]	L [mm]	
YT-2279	10.5	170	10/60

EN Universal wire stripper
PL Uniwersalny ściągacz izolacji
DE Universal Abisolierzange
RU Универсальный съёмник изоляции
CZ Univerzální odizolovací kleště
HU Blankoló fogó
RO Decablator universal
FR Extracteur d'isolation multifonction
IT Pinze per scariare isolamento
ES Extractor de aislado universal
CN 万用剥线钳

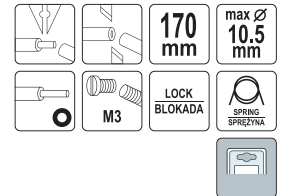

YATO 	 mm ²	 AWG	L [mm]	
YT-19691	1.6-3.2	14-8	170	6/24

EN Multifunctional pliers
PL Szczypce wielofunkcyjne
DE Multifunktionszange
RU Многофункциональные плоскогубцы
CZ Multifunkční kleště
HU Kombinált fogó
RO Patent multifunctional
FR Pince multifonctionnelle
IT Pinza universale
ES Alicates universales
CN 多功能钢丝钳

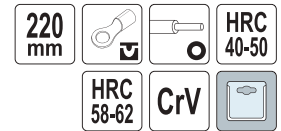

YATO 	 mm ²	 AWG	 mm ²	 AWG	L [mm]	
YT-20430	1.5	16-14	1-6	18-8	220	5/50

EN Multifunctional pliers
PL Szczypce wielofunkcyjne
DE Multifunktionszange
RU Многофункциональные плоскогубцы
CZ Multifunkční kleště
HU Kombinált fogó
RO Patent multifunctional
FR Pince multifonctionnelle
IT Pinza universale
ES Alicates universales
CN 多功能钢丝钳

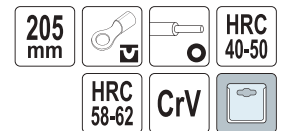

YATO 	 mm ²	 AWG	 mm ²	 AWG	L [mm]	
YT-20433	1.5	16-14	1-6	18-8	205	5/50

EN Multifunctional pliers
PL Szczypce wielofunkcyjne
DE Multifunktionszange
RU Многофункциональные плоскогубцы
CZ Multifunkční kleště
HU Kombinált fogó
RO Patent multifunctional
FR Pince multifonctionnelle
IT Pinza universale
ES Alicates universales
CN 多功能钢丝钳

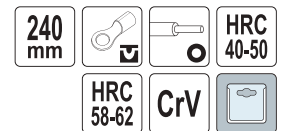

YATO 	 mm ²	 AWG	 mm ²	 AWG	L [mm]	
YT-20435	1.5	16-14	1-6	18-8	240	5/50

EN 5 in 1 pliers set for electricians
PL Zestaw szczypiec dla elektryków 5 w 1
DE Zangenset für Elektriker 5 in 1
RU Многофункциональные клещи электрика 5 в 1
CZ Sada elektrikařských kleští 5 v 1
HU Villanyezelő fogókészlet 5 az 1-ben
RO Set de clești pt. electricieni 5 în 1
FR Jeu de pinces pour électriciens 5 en 1
IT Set di pinze per elettricisti 5 in 1
ES Juego de alicates para electricistas 5 en 1
CN 5合1钳子

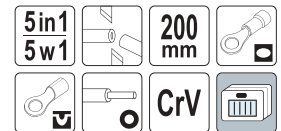

YATO 	 mm ²	 AWG	 mm ²	 AWG	 mm ²	 AWG	
YT-19697	1.5-6	22~10	1.5-6	22~10	1.5-6	22~10	4/16



EN Cable cutter
 PL Nożyce do kabli
 DE Kabelschere
 RU Кабелерезы

CZ Elektrické upichováky
 HU Kábelvágó
 RO Clește tăietor
 FR Cisailles à câbles

IT Cesoie per cavi
 ES Tijeras para cables
 CN 电缆剪

HRC 50 65Mn



YATO	Max. cutting range / Maks. przekrój cięcia [mm ²]	max. Ø [mm]	L [mm]	
YT-18610	125	12.5	370	20
YT-18611	250	18.0	580	10
YT-18612	500	25.0	770	5

EN Cable cutter
 PL Nożyce do kabli
 DE Kabelschere
 RU Кабелерезы

CZ Kleště pákové na kabely
 HU Kábelvágók
 RO Patent tăietor pt. electricie
 FR Cisailles a câbles

IT Cesoie per cavi
 ES Tijeras para cables
 CN 电缆剪

HRC 52-58 CrMo 55



YATO	Max. cutting range / Maks. przekrój cięcia [mm ²]	max. Ø [mm]	L [mm]	
YT-18615	150	13.5	450	12
YT-18616	240	17.5	600	10
YT-18617	450	23.5	910	5

EN Cable stripper
 PL Nożyk do kabli
 DE Kabelmesser

RU Нож кабельный
 CZ Nůž na kabele
 HU Kábelkés

RO Cuițăș pt. cabluri
 FR Couteau aux câbles
 IT Coltello per cavi

ES Cuchillo
 CN 电缆剥线钳

8-28 mm



YATO	Ø [mm]	
YT-2280	8-28	10/100

EN Insulated electrician scissors
 PL Nożyczki dla elektryków izolowane
 DE Elektrische Schere
 RU Ножницы диэлектрические универсальные
 CZ Elektrikářské nůžky
 HU Villanyzserelő olló
 RO Foarfeca electrician izolate
 FR Ciseaux pour electriciens
 IT Forbici per elettricisti
 ES Tijera aislante electricista
 CN 双色柄绝缘电工剪刀

160 mm CrV 1000 V



1000 V VDE CERTIFICATE EN 60900:2012

YATO	L [mm]	
YT-21200	160	6/48

EN Insulated cable knife
 PL Nóż dla elektryków izolowany
 DE Kabelmesser gerade

RU Нож кабельный изолированный
 CZ Izolovaný nůž
 HU Szerelőkés

RO Cutit pt. cabluri izolat
 FR Couteau d'électricien
 IT Coltello per elettricisti isolato

ES Cuchillo electricista aislante
 CN 双色直刀式绝缘电工刀

65Mn 1000 V



50/180 mm

1000 V VDE CERTIFICATE EN 60900:2012

38/155 mm

1000 V VDE CERTIFICATE EN 60900:2012

YATO	L [mm]	
YT-21210	180	6/72

YATO	L [mm]	
YT-21211	155	6/72

EN Cable cutter
PL Szczypce do cięcia przewodów
DE Kabelschere
RU Кабелерезы
CZ Štipací kleště na kabely
HU Kábelvágó
RO Clește tăiat cabluri
FR Pince à couper les fils
IT Cesoia per cavi elettrici
ES Alicata cortacables
CN 电缆剪

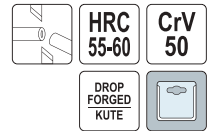

• Application: for copper and aluminium electric cables

• Przeznaczenie: do cięcia miedzianych i aluminiowych kabli

YATO	max. Ø [mm]	L [mm]	
YT-1966	6	160	6/60
YT-1967	7	210	6/60
YT-1968	8	240	6/48

EN Insulated cable cutter
PL Szczypce do cięcia przewodów izolowane
DE Kabelschere
RU Кабелерезы
CZ Izolované kleště na kabely
HU Kábelvágó
RO Clește tăiat cabluri izolat
FR Pince renforcée isolée
IT Cesoia per cavi isolata
ES Alicata cortacables aislado
CN 双色绝缘电缆剪

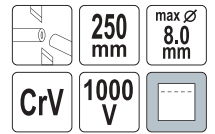

1000 V
VDE CERTIFICATE
EN 60900:2012

YATO	max. Ø [mm]	L [mm]	
YT-21141	8	250	6/36

EN Heavy duty cable cutter
PL Wzmocnione nożyce do cięcia przewodów
DE Schwere Drahtschere
RU Кабелерезы
CZ Štipací kleště na kabely
HU Kábelvágó
RO Patent tăietor pt. electrice
FR Pince renforcée à couper les fils
IT Cesoia per cavi elettrici
ES Alicata cortacables
CN 电缆剪

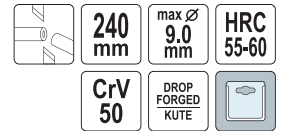

• Application: for copper and aluminium electric cables

• Przeznaczenie: do cięcia miedzianych i aluminiowych kabli

YATO	max. Ø [mm]	L [mm]	
YT-1969	9	240	6/48

EN Ratchet cable cutter
PL Nożyce zapadkowe do kabli
DE Ratschenkabelschneider

RU Кабелерез секторный
CZ Kleště na kabely, rohatka se západkou
HU Racsnis kábelvágó

RO Clește pt. tăiat cablu cu clichet
FR Cisailles à câbles
IT Cricchetto taglia cavo

ES Cortacables de carraca
CN 棘轮电缆剪



300 mm max Ø 17.5 mm

YATO	Max. cutting range / Maks. przekrój cięcia [mm ²]	max. Ø [mm]	L [mm]	
YT-18600	240	17.5	300	10

EN Voltage tester
PL Próbnik napięcia
DE Spannungsprüfer
RU Отвертка индикаторная
CZ Zkoušeč napětí
HU Fáziskereső

RO Creion de tensiune
FR Testeur de tension
IT Cerca fase
ES Comprobador de corriente
CN 测电笔

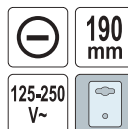

In accordance with polish standard PN-E 08509:1988

Zgodność z polską normą PN-E 08509:1988

YATO	Ø [mm]	L [mm]	
YT-28300	3	190	12/144



380 mm max Ø 22 mm

YATO	Max. cutting range / Maks. przekrój cięcia [mm ²]	max. Ø [mm]	L [mm]	
YT-18602	380	22	380	10

EN Voltage tester
PL Próbnik napięcia
DE Spannungsprüfer
RU Отвертка индикаторная
CZ Zkoušeč napětí
HU Fáziskereső

RO Creion de tensiune
FR Testeur de tension
IT Cerca fase
ES Comprobador de corriente
CN 多功能测电笔

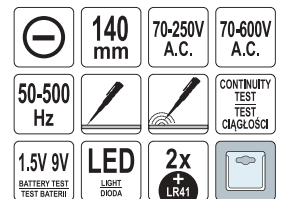

YATO	Ø [mm]	L [mm]	
YT-2864	3.5	140	6/120

EN Voltage tester
 PL Próbnik napięcia
 DE Spannungsprüfer
 RU Тестер напряжения
 CZ Zkoušeč napětí
 HU Fáziskereső

RO Creion de tensiune
 FR Testeur de tension
 IT Cerca fase
 ES Comprobador de corriente
 CN 数显带灯测电笔

140 mm
 70-250V A.C.
 70-1000V A.C.
 50-500 Hz
 CONTINUITY TEST TEST CĂGĂLOȘCI
 1.5V 9V BATTERY TEST TEST BATERII
 LED LIGHT DIODA
 2x + LR44

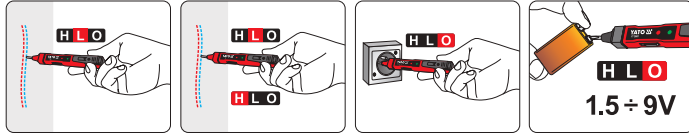

YATO L [mm] 6/120
 YT-28631 140

EN Voltage tester
 PL Próbnik napięcia
 DE Spannungsprüfer
 RU Тестер напряжения
 CZ Zkoušeč napětí
 HU Fáziskereső

RO Creion de tensiune
 FR Testeur de tension
 IT Cerca fase
 ES Comprobador de corriente
 CN 测电笔

165 mm
 12-1000V A.C.
 50/60 Hz
 CONTINUITY TEST TEST CĂGĂLOȘCI
 SENSITIVITY CZUȘOȘC
 AUTO POWER OFF AUTOMATYCZNE WYŁĄCZANIE
 LCD
 LED LIGHTING OSWETLENIENIE
 2x AAA



YATO L [mm] 100
 YT-28320 165

EN Voltage tester
 PL Próbnik napięcia
 DE Spannungsprüfer
 RU Тестер напряжения
 CZ Zkoušeč napětí
 HU Fáziskereső

RO Creion de tensiune
 FR Testeur de tension
 IT Cerca fase
 ES Comprobador de corriente
 CN 测电笔

155 mm
 12-1000V A.C.
 50/60 Hz
 CONTINUITY TEST TEST CĂGĂLOȘCI
 SENSITIVITY CZUȘOȘC
 AUTO POWER OFF AUTOMATYCZNE WYŁĄCZANIE
 LED LIGHT DIODA
 LED LIGHTING OSWETLENIENIE
 2x AAA



YATO L [mm] 120
 YT-28313 155

EN Digital voltage tester
 PL Wskaźnik elektryczny
 DE Digitaler-Spannungsprüfer
 RU Тестер напряжения цифровой

CZ Zkoušečka napětí digitální
 HU Digitális voltmérő
 RO Tester digital pt. tensiune electrica
 FR Testeur de tension type tournevis

IT Cerca fase digitale
 ES Indicador eléctrico
 CN 数显测电笔

12-250V A.C.
 50-500 Hz
 TEST
 LCD



130 mm
 CONTINUITY TEST TEST CĂGĂLOȘCI
 NO BATTERY NEEDED NE POTRĂZEBUIE BATERII
YATO L [mm] 20/500
 YT-2861 130



130 mm
 CONTINUITY TEST TEST CĂGĂLOȘCI
 LED LIGHT DIODA
 NO BATTERY NEEDED NE POTRĂZEBUIE BATERII
YATO L [mm] 20/500
 YT-2862 130



145 mm
 CONTINUITY TEST TEST CĂGĂLOȘCI
 LED LIGHT DIODA
 3x + LR41
YATO L [mm] 6/120
 YT-28630 145

EN Wire tracker (transmitter and receiver)
 PL Lokalizator przewodów (nadajnik i odbiornik)
 DE Kabelsuchgerät (Sender und Empfänger)
 RU Детектор скрытой проводки (тестер-сканер)
 CZ Lokátor kabelů (vysílač a přijímač)
 HU Vezeték detektor (jeladó és vevőegység)
 RO Detector fire (emitațor și receptor)
 FR Localisateur de câble (émetteur et récepteur)
 IT Localizzatore di cavi (trasmettitore e ricevitore)
 ES Localizador de cables (emisor y receptor)
 CN 寻线仪



WIRE TRACKING NÁMERZANIE PŘEVODU
 >1km SIGNAL TRANSMISSION TRANSMISIA SĂNALĂ
 RJ45 MULTI-COLOR WIRELESS SIGNALS
 R11 MULTI-COLOR WIRELESS SIGNALS
 ANTI-INTERFERENCE RESISTANCE NA ZĂGĂCENIA
 VOLUME GŁOȘNOSC
 FRONT LIGHT LĂTRĂRĂ
 3x AAA
 9V 6F22

YATO 10/20
 YT-73137

7

EN Digital detector with moisture test
PL Cyfrowy detektor oraz wilgotnościomierz
DE Digitaler Detektor mit Feuchtigkeitstest
RU Цифровой детектор и измеритель влажности
CZ Digitální detektor s testem vlhkosti
HU Digitális detektor nedvességvizsgálattal
RO Detector digital cu test de umiditate
FR Détecteur numérique avec test d'humidité
IT Rivelatore digitale con test di umidità
ES Detector digital con prueba de humedad
CN 墙体探测仪



- 4in1
4w1
- LCD
- 6h
- 5-50%
- 1.5-33%
- max 8 mm
- AUTO POWER OFF
AUTOMATYCZNE WYŁĄCZANIE
- 9 V
6F22

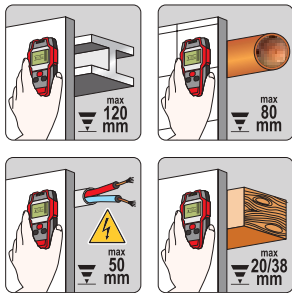

YATO YT-73138 40

EN Stud finder
PL Wykrywacz profili i przewodów
DE Entfernungsmesser
RU Цифровой детектор
CZ Digitální detektor
HU Digitális kereső műszer
RO Detector digital
FR Détecteur de métaux et de câbles électriques
IT Detector digitale
ES Escáner de pared
CN 多功能探测仪



- 3in1
3w1
- LCD
- 6h
- 9 V
6F22

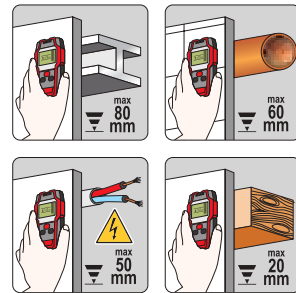

YATO YT-73131 40

EN Infrared thermometer
PL Pirometr
DE Pyrometer
RU Пирометр
CZ Pyrometr
HU Pirométer
RO Termometru cu infrarosu
FR Pyromètre
IT Termometro a infrarossi
ES Pirómetro
CN 红外测温仪



- 0.10-1 °C
EMISSIVITY EMSY, INOSC
- °C -50
°F +650
- ∅1
-124
- MAX
MIN
- °C
°F
- AUTO POWER OFF
AUTOMATYCZNE WYŁĄCZANIE
- 2x
AAA



YATO YT-73200 10/60

EN Infrared thermometer
PL Pirometr
DE Pyrometer
RU Пирометр
CZ Pyrometr
HU Pirométer
RO Termometru cu infrarosu
FR Pyromètre
IT Termometro a infrarossi
ES Pirómetro
CN 红外测温仪



- 0.10-1 °C
EMISSIVITY EMSY, INOSC
- °C -50
°F +650
- ∅1
-124
- MAX
MIN
- °C
°F
- x100
MEMORY POWER
- UV
LED
- AUTO POWER OFF
AUTOMATYCZNE WYŁĄCZANIE
- 2x
AAA

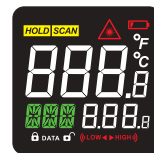

YATO YT-73201 10/60

EN Digital universal multimeter
PL Cyfrowy miernik uniwersalny
DE Digital-Multimeter
RU Универсальный цифровой измеритель
CZ Digitální multimetr univerzální
HU Digitális multiméter
RO Multimetru digital universal
FR Multimètre numérique universel
IT Universale tester digitale
ES Manómetro digital universal
CN 数字万用表



- LCD
1999
- 0-500V
D.C.
- 0-5 A
D.C.
- 0-2 MΩ
- hFE
PNP
NPN
- 9 V
6F22

YATO YT-73080 50

EN Digital universal multimeter
PL Cyfrowy miernik uniwersalny
DE Digital-Multimeter
RU Универсальный цифровой измеритель
CZ Digitální multimetr univerzální
HU Digitális multiméter
RO Multimetru digital universal
FR Multimètre numérique universel
IT Universale tester digitale
ES Manómetro digital universal
CN 数字万用表



- LCD
1999
- 0-600V
A.C.
- 0-600V
D.C.
- 0-10 A
D.C.
- 0-2 MΩ
- hFE
PNP
NPN
- 1.5V 9V
BATTERY TEST
TEST BATTERY
- DATA HOLD
- LED
BACKLIGHT
PODSWETLENIÉ
- 2x
AAA

YATO YT-73081 50

EN Digital universal multimeter
 PL Cyfrowy miernik uniwersalny
 DE Digital-Multimeter
 RU Универсальный цифровой измеритель
 CZ Digitální multimetr univerzální
 HU Digitális multiméter
 RO Multimetru digital universal
 FR Multimètre numérique universel
 IT Universale tester digitale
 ES Manómetro digital universal
 CN 数字万用表



TRUE RMS	LCD 6000	0-750V A.C.
0-1000V D.C.	0-10 A A.C.	0-10 A D.C.
0-60 MΩ	0-9.999 mF	0-9.999 MHz
1÷99%	⚡	📶
AUTO RANGE AUTO ZAKRES	DATA HOLD	LED BACKLIGHT POSSWIELENIE
AUTO POWER OFF AUTOMATYCZNE WYŁĄCZANIE	2x AAA	📦

EN Digital universal multimeter
 PL Cyfrowy miernik uniwersalny
 DE Digital-Multimeter
 RU Универсальный цифровой измеритель
 CZ Digitální multimetr univerzální
 HU Digitális multiméter
 RO Multimetru digital universal
 FR Multimètre numérique universel
 IT Universale tester digitale
 ES Manómetro digital universal
 CN 数字万用表



TRUE RMS	LCD 9999	0-750V A.C.
0-999.9V D.C.	0-9.999A A.C.	0-9.999A D.C.
0-9.999 MΩ	0-9.999 mF	0-9.999 MHz
1÷99%	📶	⚡
📶	AUTO RANGE AUTO ZAKRES	DATA HOLD
LED BACKLIGHT POSSWIELENIE	AUTO POWER OFF AUTOMATYCZNE WYŁĄCZANIE	2x AAA

YATO YT-73096 100

YATO YT-73089 100

EN Digital universal multimeter
 PL Cyfrowy miernik uniwersalny
 DE Digital-Multimeter
 RU Универсальный цифровой измеритель
 CZ Digitální multimetr univerzální
 HU Digitális multiméter
 RO Multimetru digital universal
 FR Multimètre numérique universel
 IT Universale tester digitale
 ES Manómetro digital universal
 CN 数字万用表



TRUE RMS	LCD 9999	0-600V A.C.
0-600V D.C.	0-10 A A.C.	0-10 A D.C.
0-99 MΩ	0-99 mF	0.01-60 kHz
⚡	📶	🖋️
NCV	V A.C. VFC	1.5V 9V BATTERY TEST TEST BATERII
CONTINUITY TEST TEST CIĄGŁOŚCI	AUTO RANGE AUTO ZAKRES	DATA HOLD
LED BACKLIGHT POSSWIELENIE	FRONT LIGHT LATARNIA	AUTO POWER OFF AUTOMATYCZNE WYŁĄCZANIE
	2x AAA	📦

EN Digital universal multimeter
 PL Cyfrowy miernik uniwersalny
 DE Digital-Multimeter
 RU Универсальный цифровой измеритель
 CZ Digitální multimetr univerzální
 HU Digitális multiméter
 RO Multimetru digital universal
 FR Multimètre numérique universel
 IT Universale tester digitale
 ES Manómetro digital universal
 CN 数字万用表



TRUE RMS	LCD 1999	0-600V A.C.
0-600V D.C.	0-20 A A.C.	0-20 A D.C.
0-20 MΩ	0-20 mF	°C -40 +1000
0-60 MHz	hFE PNP NPN	⚡
📶	DATA HOLD	LED BACKLIGHT POSSWIELENIE
AUTO POWER OFF AUTOMATYCZNE WYŁĄCZANIE	9 V 6F22I	📦

YATO YT-73094 40

YATO YT-73083 20

EN Digital universal multimeter
 PL Cyfrowy miernik uniwersalny
 DE Digital-Multimeter
 RU Универсальный цифровой измеритель
 CZ Digitální multimetr univerzální
 HU Digitális multiméter
 RO Multimetru digital universal
 FR Multimètre numérique universel
 IT Universale tester digitale
 ES Manómetro digital universal
 CN 数字万用表

LCD 1999	0-300V A.C.	0-300V D.C.
0-10 A A.C.	0-10 A D.C.	0-20 MΩ
0-1000 μF	°C -20 +1000	hFE PNP NPN
⚡	📶	AUTO RANGE AUTO ZAKRES
DATA HOLD	MAX HOLD	LED BACKLIGHT POSSWIELENIE
AUTO POWER OFF AUTOMATYCZNE WYŁĄCZANIE	3x AAA	📦



YATO YT-73084 44

EN Digital universal multimeter
 PL Cyfrowy miernik uniwersalny
 DE Digital-Multimeter
 RU Универсальный цифровой измеритель
 CZ Digitální multimetr univerzální
 HU Digitális multiméter
 RO Multimetru digital universal
 FR Multimètre numérique universel
 IT Universale tester digitale
 ES Manómetro digital universal
 CN 数字万用表



YATO YT-73085 20

EN Digital universal multimeter
 PL Cyfrowy miernik uniwersalny
 DE Digital-Multimeter
 RU Универсальный цифровой измеритель
 CZ Digitální multimetr univerzální
 HU Digitális multiméter
 RO Multimetru digital universal
 FR Multimètre numérique universel
 IT Universale tester digitale
 ES Manómetro digital universal
 CN 数字万用表

TRUE RMS	LCD 5999	0-600V A.C.
0-600V D.C.	0-10 A A.C.	0-10 A D.C.
0-60 MΩ	0-60 mF	0-60 MHz
°C -40 +1370	0.1÷99%	hFE PNP NPN
⚡	📶	AUTO RANGE AUTO ZAKRES
DATA HOLD	MAX HOLD	MIN HOLD
LED BACKLIGHT POSSWIELENIE	AUTO POWER OFF AUTOMATYCZNE WYŁĄCZANIE	CATCH MOCOWANIE
	9 V 6F22I	📦

For YT-73090
 Dla YT-73090

EN Digital universal multimeter
 PL Cyfrowy miernik uniwersalny
 DE Digital-Multimeter
 RU Универсальный цифровой измеритель
 CZ Digitální multimetr univerzální
 HU Digitális multiméter
 RO Multimetru digital universal
 FR Multimètre numérique universel
 IT Universale tester digitale
 ES Manómetro digital universal
 CN 数字万用表



YATO YT-730893 50

EN Digital universal multimeter
PL Cyfrowy miernik uniwersalny
DE Digital-Multimeter
RU Универсальный цифровой измеритель
CZ Digitální multimetr univerzální
HU Digitális multiméter
RO Multimetru digital universal
FR Multimètre numérique universel
IT Universale tester digitale
ES Manómetro digital universal
CN 数字万用表

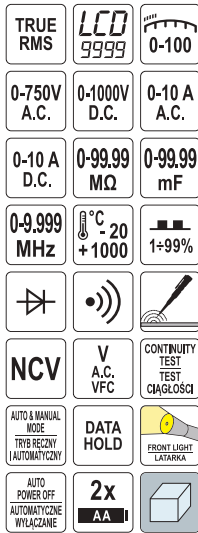

YATO
YT-73097 30

EN Digital universal multimeter
PL Cyfrowy miernik uniwersalny
DE Digital-Multimeter
RU Универсальный цифровой измеритель
CZ Digitální multimetr univerzální
HU Digitális multiméter
RO Multimetru digital universal
FR Multimètre numérique universel
IT Universale tester digitale
ES Manómetro digital universal
CN 数字万用表

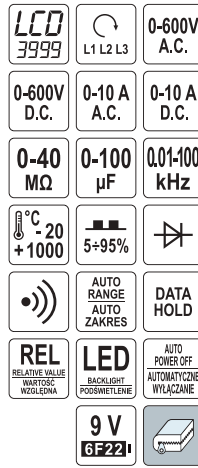

YATO
YT-73086 24

EN Digital universal multimeter
PL Cyfrowy miernik uniwersalny
DE Digital-Multimeter
RU Универсальный цифровой измеритель
CZ Digitální multimetr univerzální
HU Digitális multiméter
RO Multimetru digital universal
FR Multimètre numérique universel
IT Universale tester digitale
ES Manómetro digital universal
CN 数字万用表

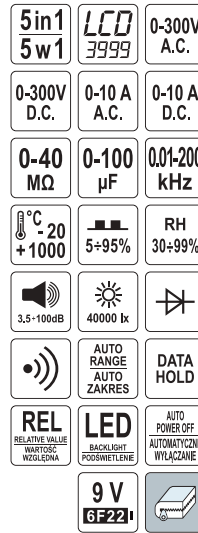

YATO
YT-73087 24

EN Clamp universal multimeter
PL Cęgowy miernik uniwersalny
DE Universal Zangenamperemeter
RU Универсальный цифровой измеритель
CZ Digitální multimetr univerzální
HU Digitális multiméter
RO Multimetru digital universal
FR Pince multimetre universel
IT Universale tester digitale
ES Manómetro digital universal
CN 数字钳形万用表



For YT-73085
Dla YT-73085

YATO
YT-73090 50

EN Clamp universal multimeter
PL Cęgowy miernik uniwersalny
DE Universal Zangenamperemeter
RU Универсальный цифровой измеритель
CZ Digitální multimetr univerzální
HU Digitális multiméter
RO Multimetru digital universal
FR Pince multimetre universel
IT Universale tester digitale
ES Manómetro digital universal
CN 数字钳形万用表

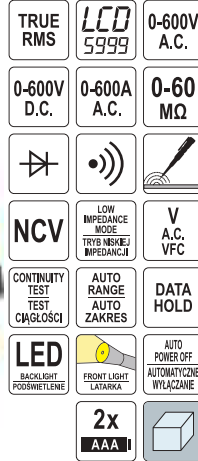

YATO
YT-73092 40

EN Clamp universal multimeter
PL Cęgowy miernik uniwersalny
DE Universal Zangenamperemeter
RU Универсальный цифровой измеритель
CZ Digitální multimetr univerzální
HU Digitális multiméter
RO Multimetru digital universal
FR Pince multimetre universel
IT Universale tester digitale
ES Manómetro digital universal
CN 数字钳形万用表



YATO
YT-73091 20

EN Clamp universal multimeter
PL Cęgowy miernik uniwersalny
DE Universal Zangenamperemeter
RU Универсальный цифровой измеритель
CZ Digitální multimetr univerzální
HU Digitális multiméter
RO Multimetru digital universal
FR Pince multimetre universel
IT Universale tester digitale
ES Manómetro digital universal
CN 数字钳形万用表

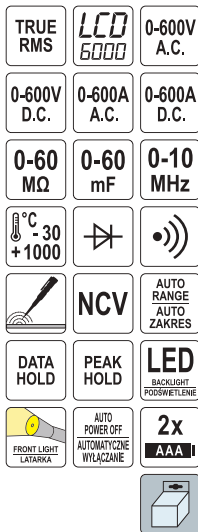

YATO
YT-73093 50

EN Probe set for multimeters
PL Zestaw sond pomiarowych do mierników
DE Sondensatz für Multimeter
RU Набор зонд для тестеров
CZ Měřicí šňůry k multimetru
HU Mérőrszínor pár digitális multiméterekhez
RO Set sonde pt. multimetru
FR Jeu de cordons de test multimètre
IT Kit di puntali per misuratori
ES Juego de sondas de medición para medidores
CN 表笔

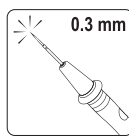

YATO
YT-73077 50/100

EN Probe set for multimeters
PL Zestaw sond pomiarowych do mierników
DE Sondensatz für Multimeter
RU Набор зонд для тестеров
CZ Měřicí šňůry k multimetru
HU Mérőrszínor pár digitális multiméterekhez
RO Set sonde pt. multimetru
FR Jeu de cordons de test multimètre
IT Kit di puntali per misuratori
ES Juego de sondas de medición para medidores
CN 表笔



YATO
YT-73078 50/100

EN Tweezer RO Pensetă
 PL Pęseta FR Pince
 DE Pinzette IT Pinza
 RU Пинцет ES Pinzas
 CZ Pinzeta CN 尖头镊子
 HU Csipesz



140 mm **SS302** **HRC 30** **ANTI-MAGNETIC** **ACID PROOF**
STAINLESS STEEL STAL NIERDZEWNA ANTI-MAGNETICzne KWASO-ODPORNOŚĆ

YATO	L [mm]	
YT-6903	140	20/240

EN Tweezer RO Pensetă
 PL Pęseta FR Pince
 DE Pinzette IT Pinza
 RU Пинцет ES Pinzas
 CZ Pinzeta CN 弯头镊子
 HU Csipesz



115 mm **SS302** **HRC 30** **ANTI-MAGNETIC** **ACID PROOF**
STAINLESS STEEL STAL NIERDZEWNA ANTI-MAGNETICzne KWASO-ODPORNOŚĆ

YATO	L [mm]	
YT-6907	115	20/240

EN Tweezer RO Pensetă
 PL Pęseta FR Pince
 DE Pinzette IT Pinza
 RU Пинцет ES Pinzas
 CZ Pinzeta CN 防静电镊子
 HU Csipesz



140 mm **SS302** **HRC 40** **ANTI-MAGNETIC** **ACID PROOF**
STAINLESS STEEL STAL NIERDZEWNA ANTI-MAGNETICzne KWASO-ODPORNOŚĆ

YATO	L [mm]	
YT-6916	140	20/240

EN Insulation tape
 PL Taśma elektroizolacyjna
 DE Isolierband
 RU Изолента
 CZ Izolační páska
 HU Szigetelőszalag
 RO Banda izolatoare
 FR Ruban électrique
 IT Nastro isolante
 ES Cinta aislante
 CN 绝缘胶带



- In accordance with standard EN 60454-3-1-1/F-PVC/60/R-Tp
- Dielectric strength: >40 Kv/mm
- Elongation: >125%
- Flame test: Store temperature: 10-40°C
- Using temperature: 5-50°C
- Zgodność z normą EN 60454-3-1-1/F-PVC/60/R-Tp
- Wytrzymałość dielektryczna: >40 Kv/mm
- Wydłużenie: >125%
- Test ogniowy: Temperatura składowania: 10-40°C
- Temperatura użytkowania: 5-50°C

YATO	W [mm]	L [m]	+/- [mm]	
YT-8152	12	10	0.13	96/384
YT-8159	15	20	0.13	72/288
YT-8165	19	20	0.13	72/288
YT-8174	25	20	0.19	48/192
YT-8177	50	33	0.19	48

EN Insulation tape
 PL Taśma elektroizolacyjna
 DE Isolierband
 RU Изолента
 CZ Izolační páska
 HU Szigetelőszalag
 RO Banda izolatoare
 FR Ruban électrique
 IT Nastro isolante
 ES Cinta aislante
 CN 红色电工绝缘胶带



- In accordance with standard EN 60454-3-1-1/F-PVC/60/R-Tp
- Dielectric strength: >40 Kv/mm
- Elongation: >125%
- Flame test: Store temperature: 10-40°C
- Using temperature: 5-50°C
- Zgodność z normą EN 60454-3-1-1/F-PVC/60/R-Tp
- Wytrzymałość dielektryczna: >40 Kv/mm
- Wydłużenie: >125%
- Test ogniowy: Temperatura składowania: 10-40°C
- Temperatura użytkowania: 5-50°C

YATO	W [mm]	L [m]	+/- [mm]	
YT-81592	15	20	0.13	72/288
YT-8166	19	20	0.13	72/288

EN Insulation tape
 PL Taśma elektroizolacyjna
 DE Isolierband
 RU Изолента
 CZ Izolační páska
 HU Szigetelőszalag
 RO Banda izolatoare
 FR Ruban électrique
 IT Nastro isolante
 ES Cinta aislante
 CN 蓝色电工绝缘胶带



- In accordance with standard EN 60454-3-1-1/F-PVC/60/R-Tp
- Dielectric strength: >40 Kv/mm
- Elongation: >125%
- Flame test: Store temperature: 10-40°C
- Using temperature: 5-50°C
- Zgodność z normą EN 60454-3-1-1/F-PVC/60/R-Tp
- Wytrzymałość dielektryczna: >40 Kv/mm
- Wydłużenie: >125%
- Test ogniowy: Temperatura składowania: 10-40°C
- Temperatura użytkowania: 5-50°C

YATO	W [mm]	L [m]	+/- [mm]	
YT-81591	15	20	0.13	72/288
YT-81651	19	20	0.13	72/288

EN Insulation tape
 PL Taśma elektroizolacyjna
 DE Isolierband
 RU Изолента
 CZ Izolační páska
 HU Szigetelőszalag
 RO Banda izolatoare
 FR Ruban électrique
 IT Nastro isolante
 ES Cinta aislante
 CN 黄色电工绝缘胶带



- In accordance with standard EN 60454-3-1-1/F-PVC/60/R-Tp
- Dielectric strength: >40 Kv/mm
- Elongation: >125%
- Flame test: Store temperature: 10-40°C
- Using temperature: 5-50°C
- Zgodność z normą EN 60454-3-1-1/F-PVC/60/R-Tp
- Wytrzymałość dielektryczna: >40 Kv/mm
- Wydłużenie: >125%
- Test ogniowy: Temperatura składowania: 10-40°C
- Temperatura użytkowania: 5-50°C

YATO	W [mm]	L [m]	+/- [mm]	
YT-81594	15	20	0.13	72/288
YT-81654	19	20	0.13	72/288

EN Insulation tape
 PL Taśma elektroizolacyjna
 DE Isolierband
 RU Изолента
 CZ Izolační páska
 HU Szigetelőszalag
 RO Banda izolatoare
 FR Ruban électrique
 IT Nastro isolante
 ES Cinta aislante
 CN 黄绿色电工绝缘胶带



- In accordance with standard EN 60454-3-1-1/F-PVC/60/R-Tp
- Dielectric strength: >40 Kv/mm
- Elongation: >125%
- Flame test: Store temperature: 10-40°C
- Using temperature: 5-50°C
- Zgodność z normą EN 60454-3-1-1/F-PVC/60/R-Tp
- Wytrzymałość dielektryczna: >40 Kv/mm
- Wydłużenie: >125%
- Test ogniowy: Temperatura składowania: 10-40°C
- Temperatura użytkowania: 5-50°C

YATO	W [mm]	L [m]	+/- [mm]	
YT-81593	15	20	0.13	72/288
YT-81655	19	20	0.13	72/288

EN Insulation tape
 PL Taśma elektroizolacyjna
 DE Isolierband
 RU Изолента
 CZ Izolační páska
 HU Szigetelőszalag
 RO Banda izolatoare
 FR Ruban électrique
 IT Nastro isolante
 ES Cinta aislante
 CN 绿色电工绝缘胶带



- In accordance with standard EN 60454-3-1-1/F-PVC/60/R-Tp
- Dielectric strength: >40 Kv/mm
- Elongation: >125%
- Flame test: Store temperature: 10-40°C
- Using temperature: 5-50°C
- Zgodność z normą EN 60454-3-1-1/F-PVC/60/R-Tp
- Wytrzymałość dielektryczna: >40 Kv/mm
- Wydłużenie: >125%
- Test ogniowy: Temperatura składowania: 10-40°C
- Temperatura użytkowania: 5-50°C

YATO	W [mm]	L [m]	+/- [mm]	
YT-81595	15	20	0.13	72/288
YT-81652	19	20	0.13	72/288

7

EN Insulation tape
PL Taśma elektroizolacyjna
DE Isolierband
RU Изолента
CZ Izolační páska
HU Szigetelőszalag
RO Banda izolatoare
FR Ruban électrique
IT Nastro isolante
ES Cinta aislante
CN 绝缘胶带



10
PCS



- In accordance with standard EN 60454-3-1-1/F-PVC/60/R-Tp
- Dielectric strength: >40 Kv/mm
- Elongation: >125%
- Flame test: Store temperature: 10-40°C
- Using temperature: 5-50°C

- Țigodnosc z normy EN 60454-3-1-1/F-PVC/60/R-Tp
- Wytrzymałość dielektryczna: >40 Kv/mm
- Wydłużenie: >125%
- Test ognioy: Temperatura składowania: 10-40°C
- Temperatura użytkowania: 5-50°C

YATO	W [mm]	L [m]	± [mm]	
YT-8156	12	10	0.13	10/40
YT-8173	19	20	0.13	6/24

EN Tool set for electricians
PL Zestaw narzędziowy dla elektryków
DE Werkzeug-Set für Elektriker
RU Набор инструментов для электриков
CZ Sada nářadí pro elektrikáře
HU Szerszámkészlet villanyszerelők

RO Trusa electrician
FR Ensemble d'outils pour les électriciens
IT Set per l'elettricista
ES Conjunto de herramientas para electricistas
CN 高档电组套



68
PCS

1/4"
6.3mm

1000
V

CrV
50BV30

CrV
6150

S2

- 1/4" (6.3 mm): 4, 4.5, 5, 5.5, 6, 7, 8, 9, 10, 11, 12, 13 mm (L=25 mm); CrV 50BV30;
- 140 mm;
- 190 mm; 3CRB;
- 150 mm;
- 160 mm; 1000 V; CrV;
- 160 mm; 1000 V; CrV;
- 3 m x 16 mm;
- 175 mm;
- 19.5 x 190 mm;
- 1.5 V; 9 LED;
- 9 mm;

- 19 mm x 20 mm;
- 1/4" (6.3 mm); (150 mm); CrV 50BV30;
- 1/4" (6.3 mm) x 1/4" (6.3 mm); CrV 6140;
- 10 g;
- 1.4, 2.0, 2.4 mm; PH00, PH0, PH1; S2;
- 4x100, 5.5x125, PH1x80, PH2x100 mm; 1000V; S2;
- 1/4" (6.3 mm); 3, 4, 5, 5.5, 6 mm (L=25 mm); AISI S2;
- 1/4" (6.3 mm); PH1, PH2, PH3 (L=25 mm); AISI S2;
- 1/4" (6.3 mm); T8, T10, T15, T20, T25, T27 (L=25 mm); AISI S2;
- 1/4" (6.3 mm); 2, 2.5, 3, 4, 5, 6 (L=25 mm); AISI S2;
- 1.5, 2, 2.5, 3, 4, 5, 6, 7, 8, 10 mm; CrV 6150

YATO		
YT-39009	1/4" (6.3 mm)	2

EN Cable access
PL Przepychacz przewodów
DE Kabel Einziehhilfe

RU Устройство для протяжки кабеля
CZ Pero protahovací
HU Kábelhúzó szalag

RO Dispozitiv de tragere a cablurilor
FR Les baguettes tire fil
IT Dispositivo tiracavi

ES Guía de fibra de vidrio
CN 玻璃纤维杆

14
PCS

10x1
m

BRASS
MOSIADZ

FIBERGLASS
WŁOKNO
SZKLANE



YATO		
YT-23200		12/36

EN Cable access accessories
PL Akcesoria do przepychacza do przewodów
DE Kabel Einziehhilfe Accessoires
RU Устройство для протяжки кабеля - аксесуары
CZ Pero protahovací příslušenství
HU Kábelhúzó szalag kiegészítők

RO Accesorii pt. dispozitiv de tragere a cablurilor
FR Les baguettes tire fil accessoires
IT Accessori per il dispositivo tiracavi
ES Guía de fibra de vidrio accesorios
CN 铜接头

5
PCS

BRASS
MOSIADZ



YATO		
YT-23201		24/144

EN Cable access
PL Przepychacz przewodów
DE Kabel Einziehhilfe
RU Устройство для протяжки кабеля
CZ Pero protahovací
HU Kábelhúzó szalag
RO Dispozitiv de tragere a cablurilor
FR Les baguettes tire fil
IT Dispositivo tiracavi
ES Guía de fibra de vidrio
CN 穿线器



15.3
m

3x15
mm

STEEL
STAL

ABS

BRAKE
HAMULEC

YATO	L [m]	
YT-25010	15.3	6/12

EN Cable access
PL Przepychacz przewodów
DE Kabel Einziehhilfe
RU Устройство для протяжки кабеля
CZ Pero protahovací
HU Kábelhúzó szalag
RO Dispozitiv de tragere a cablurilor
FR Les baguettes tire fil
IT Dispositivo tiracavi
ES Guía de fibra de vidrio
CN 穿线器



30m

4.0
mm

FIBERGLASS
WŁOKNO
SZKLANE

YATO	L [m]	Ø [mm]	
YT-25015	30	4	10

8

**Hammers, chisels,
punches & axes
Młotki, dłuta,
przecinaki i siekiery**



Machinist hammers Młotki ślusarskie		136
--	---	-----

Geological hammers Młotki geologiczne		139
--	---	-----

Stoning hammers Młotki kamieniarskie		136
---	---	-----

Chisels, cold chisels & punches Dłuta, przecinaki i przebijaki		139-143
---	---	---------

Hammers with tubular steel handle Młotki z trzonkiem rurowym		137
---	---	-----

Wood chisels & sets Dłuta stolarskie i zestawy	139
Cold chisels Przecinaki	140
Pin punches Wybijaki	141
Punches Punktaki	141
Cold chisel & punch sets Zestawy przecinaków i punktaków	141

Claw hammers Młotki szewskie	137
Roofing hammers Młotki ciesielskie	137
Mason's hammers Młotki murarskie	137
Plasterer's hatchets Toporki tynkarskie	137

Wrecking bars Łomy		143-144
-----------------------	---	---------

Fully drop forged hammers Młotki monolityczne kute		137
---	---	-----

Axes Siekiery		144-145
------------------	---	---------

Claw hammers Młotki szewskie	137
Roofing hammers Młotki ciesielskie	137
Mason's hammers Młotki murarskie	137

Adzes Ciośla		145
-----------------	--	-----

Rubber mallets Młotki gumowe		138
---------------------------------	---	-----

Forestry tools Narzędzia leśne		145-146
-----------------------------------	---	---------

Dead blow hammers Młotki bezodrzutowe		138
--	---	-----

Ball pein hammers & sets Młotki blacharskie i zestawy		139
--	---	-----



EN Machinist hammer
 PL Młotek ślusarski
 DE Schlosserhammer
 RU Молоток слесарный
 CZ Zámečnické kladivo
 HU Lakatos kalapács
 RO Ciocan de lăcătușerie
 FR Marteau de serrurier
 IT Martello da fabbro
 ES Martillo de cerrajero
 CN 钳工锤

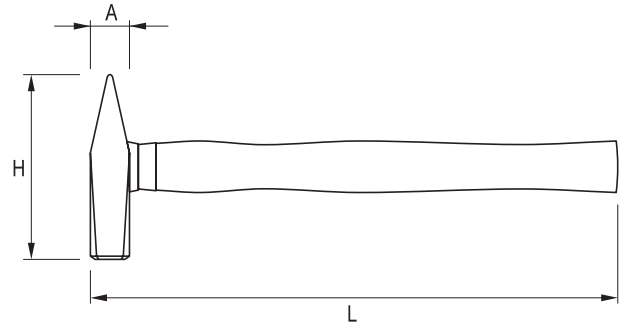

DIN 1041 **DROP FORGED KUTE** 



- High quality wooden handle
- Forged carbon steel head
- Safety protection steel ring

- Drewniany trzonek wysokiej jakości
- Kuty obuch ze stali węglowej
- Klin pierścieniowy zapewniający bezpieczeństwo

YATO 	m [g]	L [mm]	A [mm]	H [mm]	
YT-4491	100	260	15	80	12/120
YT-4492	200	280	20	93	6/60
YT-4493	300	300	21	103	6/60
YT-4494	400	310	23	111	6/48
YT-4495	500	320	26	118	6/36

YATO 	m [g]	L [mm]	A [mm]	H [mm]	
YT-4496	600	330	28	119	6/36
YT-4497	800	350	31	125	6/24
YT-4498	1000	360	35	132	6/24
YT-4499	1500	380	40	143	6/12
YT-4500	2000	400	45	153	6/12

8



EN Machinist hammer
 PL Młotek ślusarski
 DE Schlosserhammer
 RU Молоток слесарный
 CZ Zámečnické kladivo
 HU Lakatos kalapács
 RO Ciocan de lăcătușerie
 FR Marteau de serrurier
 IT Martello da fabbro
 ES Martillo de cerrajero
 CN 钳工锤

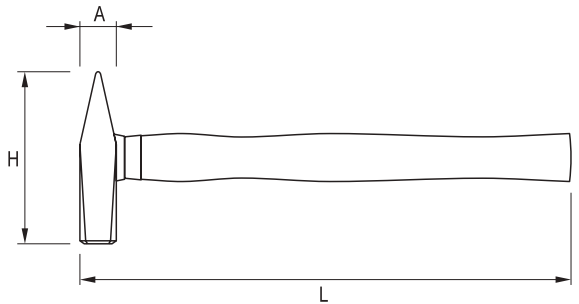

DIN 1041 **DROP FORGED KUTE** 



- High quality wooden handle
- Forged carbon steel head
- Safety protection steel ring

- Drewniany trzonek wysokiej jakości
- Kuty obuch ze stali węglowej
- Klin pierścieniowy zapewniający bezpieczeństwo

YATO 	m [g]	L [mm]	A [mm]	H [mm]	
YT-4501	100	260	15	82	12/120
YT-4502	200	280	19	95	6/60
YT-4503	300	300	23	105	6/60
YT-4504	400	310	25	112	6/48
YT-4505	500	320	27	118	6/36

YATO 	m [g]	L [mm]	A [mm]	H [mm]	
YT-4506	600	330	29	122	6/36
YT-4507	800	350	33	135	6/24
YT-4508	1000	360	36	135	6/24
YT-4509	1500	380	42	145	6/12
YT-4510	2000	400	47	155	6/12



EN Safety stoning hammer
 PL Młotek kamieniarski
 DE Faustel
 RU Молоток каменщика
 CZ Palička kovová
 HU Kőtörő kalapács
 RO Ciocan pt. zidarie
 FR Marteau de tailleur de pierres
 IT Martello da aggiustatore
 ES Martillo
 CN 石工锤

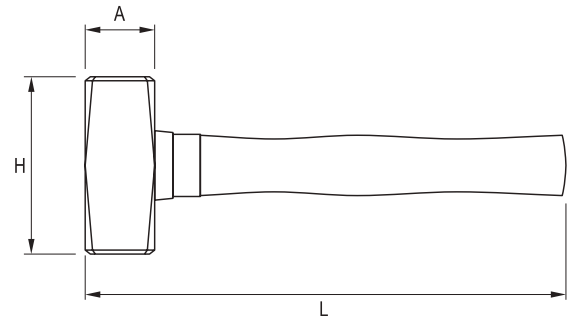

DIN 6475 **DROP FORGED KUTE** 



- High quality wooden handle
- Forged carbon steel head
- Safety protection steel ring

- Drewniany trzonek wysokiej jakości
- Kuty obuch ze stali węglowej
- Klin pierścieniowy zapewniający bezpieczeństwo



YATO 	m [g]	L [mm]	A [mm]	H [mm]	
YT-4550	1000	260	40	95	6/24
YT-4551	1250	260	43	100	6/24

YATO 	m [g]	L [mm]	A [mm]	H [mm]	
YT-4552	1500	280	45	110	6/12
YT-4553	2000	300	50	120	6/12

EN Claw hammer
 PL Młotek szewski
 DE Schusterhammer
 RU Молоток гвоздодеп
 CZ Kladivo obuvnické
 HU Cipész kalapács
 RO Ciocan pt. cizmărie
 FR Marteau de cordonnier
 IT Martello da calzolaio
 ES Martillo carpintero
 CN 羊角锤





- High quality steel handle
- Forged carbon steel head hardened and tempered
- Stalowy trzonek
- Bijak ze stali węglowej, kuty, ulepszony cieplnie

YATO 	m [g]	L [mm]	A [mm]	H [mm]	
YT-4560	450	318	30	130	6/24

EN Roofing hammer
 PL Młotek ciesielski
 DE Lattenhammer
 RU Молоток кровельщика
 CZ Tesařské kladivo
 HU Ácskalapács
 RO Ciocan de dulgherie
 FR Marteau de charpentier
 IT Martello da carpentiere
 ES Martillo de carpintero
 CN 独角锤



- High quality steel handle
- Forged carbon steel head hardened and tempered
- Stalowy trzonek
- Bijak ze stali węglowej, kuty, ulepszony cieplnie

YATO 	m [g]	L [mm]	A [mm]	H [mm]	
YT-4561	600	318	25x25	165	6/24

EN Masonry hammer, type B
 PL Młotek murarski berliński
 DE Maurerhammer, Berliner Form
 RU Молоток каменщика берлинский
 CZ Kladivo zednické berlinské
 HU Kőműves kalapács Berlińi típusú
 RO Ciocan de zidărie tip Berlin
 FR Marteau du maçon berlinois
 IT Martello da muratore, tipo Berlino
 ES Martillo de albañil de Berlín
 CN 泥工锤

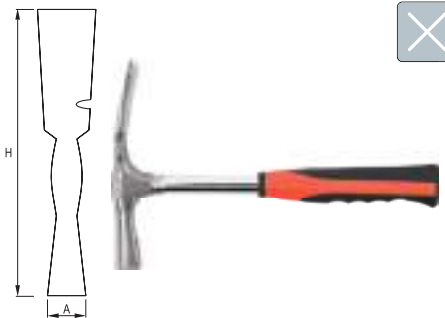

- High quality steel handle
- Forged carbon steel head hardened and tempered
- Stalowy trzonek
- Bijak ze stali węglowej, kuty, ulepszony cieplnie

YATO 	m [g]	L [mm]	A [mm]	H [mm]	
YT-4562	600	315	24x23	200	6/24

EN Masonry hammer, type R
 PL Młotek murarski reński
 DE Maurerhammer, Rheinische Form
 RU Молоток каменщика рейнский
 CZ Kladivo zednické rýnské
 HU Kőműves kalapács Rajnai típusú
 RO Ciocan de zidărie tip Rin
 FR Marteau de maçon, modèle Rhin
 IT Martello da muratore, tipo Reno
 ES Martillo de albañil de Rin
 CN 泥工锤



- High quality steel handle
- Forged carbon steel head hardened and tempered
- Stalowy trzonek
- Bijak ze stali węglowej, kuty, ulepszony cieplnie

YATO 	m [g]	L [mm]	A [mm]	H [mm]	
YT-4563	600	315	23x23	170	6/24

EN Plasterer's hatchet
 PL Toporek tynkarski
 DE Gipserbeil
 RU Топор штукатурный
 CZ Omitáč sekýrka
 HU Kőműves szekerce
 RO Toporaş de tencuit
 FR Hachette de plâtrier
 IT Martello con accetta
 ES Hacha enlucido
 CN 多用斧





- High quality steel handle
- Forged carbon steel head hardened and tempered
- Stalowy trzonek
- Bijak ze stali węglowej, kuty, ulepszony cieplnie

YATO 	m [g]	L [mm]	A [mm]	H [mm]	
YT-4564	600	315	25x20	175	6/24

EN Claw hammer
 PL Młotek szewski
 DE Schusterhammer
 RU Молоток гвоздодеп
 CZ Kladivo obuvnické
 HU Cipész kalapács
 RO Ciocan pt. cizmărie
 FR Marteau de cordonnier
 IT Martello da calzolaio
 ES Martillo carpintero
 CN 羊角锤



- High quality steel handle
- Forged carbon steel head hardened and tempered
- Stalowy trzonek
- Bijak ze stali węglowej, kuty, ulepszony cieplnie

YATO 	m [g]	L [mm]	A [mm]	H [mm]	
YT-4570	450	315	30	130	6/24

EN Roofing hammer
 PL Młotek ciesielski
 DE Lattenhammer
 RU Молоток кровельщика
 CZ Tesařské kladivo
 HU Ácskalapács
 RO Ciocan de dulgherie
 FR Marteau de charpentier
 IT Martello da carpentiere
 ES Martillo de carpintero
 CN 独角锤



- High quality steel handle
- Forged carbon steel head hardened and tempered
- Stalowy trzonek
- Bijak ze stali węglowej, kuty, ulepszony cieplnie

YATO 	m [g]	L [mm]	A [mm]	H [mm]	
YT-4571	600	331	25x25	165	6/24

EN Masonry hammer, type R
 PL Młotek murarski reński
 DE Maurerhammer, Rheinische Form
 RU Молоток каменщика рейнский
 CZ Kladivo zednické rýnské
 HU Kőműves kalapács Rajnai típusú
 RO Ciocan de zidărie tip Rin
 FR Marteau de maçon, modèle Rhin
 IT Martello da muratore, tipo Reno
 ES Martillo de albañil de Rin
 CN 泥工锤



- High quality steel handle
- Forged carbon steel head hardened and tempered
- Stalowy trzonek
- Bijak ze stali węglowej, kuty, ulepszony cieplnie

YATO 	m [g]	L [mm]	A [mm]	H [mm]	
YT-4573	600	382	25x24	158	6/24

- EN Rubber mallet
- PL Młotek gumowy
- DE Gummihammer
- RU Киянка резиновая
- CZ Pryžové kladivo
- HU Gumikalapács
- RO Ciocan de cauciuc
- FR Marteau en caoutchouc
- IT Martello di gomma
- ES Mazo de goma
- CN 橡胶锤



YATO	m [g]	L [mm]	Ø [mm]	H [mm]	
YT-4594	440	340	50	87.5	6/36

- EN Rubber mallet
- PL Młotek gumowy
- DE Gummihammer
- RU Киянка резиновая
- CZ Pryžové kladivo
- HU Gumikalapács
- RO Ciocan de cauciuc
- FR Marteau en caoutchouc
- IT Martello di gomma
- ES Mazo de goma
- CN 橡胶锤



YATO	m [g]	L [mm]	Ø [mm]	H [mm]	
YT-4601	340	291	49	79.5	12/48
YT-4602	370	300	50	87.5	6/36
YT-4603	580	341	58	96	6/36
YT-4604	780	341	63	117	6/24
YT-4605	980	345	72	122	6/24

- EN Dead blow mallet
- PL Młotek bezodrzutowy
- DE Rückschlagsfreier Schonhammer
- RU Молоток безинерционный
- CZ Palička nárazová plněná celogumová
- HU Visszarúgás mentes gumikalapács
- RO Ciocan cu absorbție
- FR Maillet sans recul
- IT Martello morto colpo
- ES Martillo sin reacción
- CN 防震无回弹橡胶锤



YATO	m [g]	L [mm]	Ø [mm]	H [mm]	
YT-4620	740	300	44.5	100	4/24
YT-4622	900	336	53.5	100	4/24
YT-4623	1300	350	59	118.5	3/12

8

- EN Dead blow mallet
- PL Młotek bezodrzutowy
- DE Rückschlagsfreier Schonhammer
- RU Молоток безинерционный
- CZ Palička nárazová plněná celogumová
- HU Visszarúgás mentes gumikalapács
- RO Ciocan cu absorbție
- FR Maillet sans recul
- IT Martello morto colpo
- ES Martillo sin reacción
- CN 橡胶锤



YATO	m [g]	L [mm]	[mm]	
YT-46270	2400	490	70x70x140	2/6
YT-46273	5500	900	105x105x180	2

- EN Dead blow mallet
- PL Młotek bezodrzutowy
- DE Rückschlagsfreier Schonhammer
- RU Молоток безинерционный
- CZ Palička nárazová plněná celogumová
- HU Visszarúgás mentes gumikalapács
- RO Ciocan cu absorbție
- FR Maillet sans recul
- IT Martello morto colpo
- ES Martillo sin reacción
- CN 尼龙安装锤



YATO	m [g]	L [mm]	Ø [mm]	H [mm]	
YT-4624	265	318	30	94	10/40
YT-4625	430	350	40	100	6/36
YT-4626	490	348	45	110	6/36

- EN Dead blow mallet
- PL Młotek bezodrzutowy
- DE Rückschlagsfreier Schonhammer
- RU Молоток безинерционный
- CZ Palička nárazová plněná celogumová
- HU Visszarúgás mentes gumikalapács
- RO Ciocan cu absorbție
- FR Maillet sans recul
- IT Martello morto colpo
- ES Martillo sin reacción
- CN 铜头无弹力锤



YATO	m [g]	L [mm]	Ø [mm]	H [mm]	
YT-46190	300	225	20	75	6/36
YT-46191	700	330	32	110	6/24

- EN Soft face hammer
- PL Młotek blacharski
- DE Schonhammer
- RU Молоток рихтовочный
- CZ Palička klempířská
- HU Bádógos kalapács
- RO Ciocan tinichigene
- FR Marteau de carrossier
- IT Martello da battilastra
- ES Martillo chapista
- CN 木柄安装锤



YATO	m [g]	L [mm]	Ø [mm]	H [mm]	
YT-4630	150	250	22	75	6/48
YT-4631	250	280	28	85	6/36
YT-4632	340	315	35	95	6/36
YT-4633	660	350	45	105	6/24
YT-4634	1340	380	60	132	4/16

- EN Aluminum hammer
- PL Młotek aluminiowy
- DE Aluminium-Hammer
- RU Алюминиевый молоток
- CZ Hliníkové kladivo
- HU Alumínium kalapács
- RO Ciocan aluminiu
- FR Marteau en aluminium
- IT Martello in alluminio
- ES Martillo de aluminio
- CN 铝锤



YATO	m [g]	L [mm]	Ø [mm]	H [mm]	
YT-45280	150	280	30	80	6/36
YT-45281	300	300	40	98	6/36
YT-45282	580	320	50	105	6/24

- EN Mounting hammer
- PL Młotek montażowy z wymiennymi końcówkami
- DE Montagehammer
- RU Установка молоток
- CZ Montážní kladivo
- HU Szerelő kalapács
- RO Montare ciocan
- FR Marteau de montage
- IT Martello di montaggio con punte intercambiabili
- ES Martillo de montaje
- CN 铝合金多用安装锤

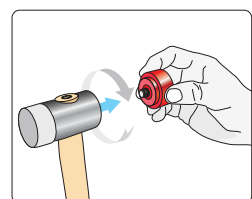

Grey circle	HRC: 65 +/-5
Red circle	HRC: 72 +/-5
Blue circle	HRC: 73 +/-5
White circle	HRC: 80 +/-5
Black circle	HRC: 95 +/-5

YATO	
YT-45905	8

EN Auto body fender set
PL Komplet młotków blacharskich
DE Karosserie-Ausbeulsatz
RU Молотки рихтовочные
CZ Souprava klempířských kladívek
HU Bádógos kalapács készlet
RO Set de ciocane de tablă
FR Set pour carrossier
IT Martello per lamiera
ES Juego de mazos de hojalatero
CN 钣金工具组套



7 PCS
DROP FORGED KUTE
HICKORY WOOD DREWNIANA REKOWIEC



YATO	m [g]	
YT-4590	4900	4

EN Ball pein hammer
PL Młotek blacharski
DE Ausbeulhammer
RU Молоток рихтовочный

CZ Klempířské kladívko
HU Bádógos kalapács
RO Ciocan pt. tabla
FR Marteau à panne ronde

IT Martello per lamiera
ES Martillo de hojalatero
CN 纤维柄圆头锤

FIBERGLASS WŁÓKNO SZKLANE



YATO	m [g]	L [mm]	A [mm]	H [mm]	
YT-4515	225	280	26	80	6/36
YT-4516	450	315	34	100	6/24
YT-4518	900	380	40	125	6/12

EN Geological hammer
PL Młotek geologiczny
DE Geologenhammer
RU Геологический молоток
CZ Geologické kladívo
HU Geológuskalapács
RO Ciocan geologic
FR Marteau de géologue
IT Martello da geologo
ES Martillo de geólogo
CN 地质锤

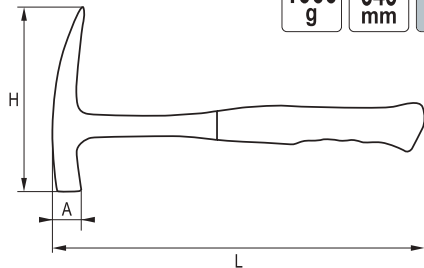

1000 g 345 mm



YATO	m [g]	L [mm]	A [mm]	H [mm]	
YT-45650	1000	345	20x20	180	6/18

EN Wood chisel
PL Dłuto stolarskie
DE Stechbeitel
RU Стамеска по дереву
CZ Dláto tesařské
HU Asztalos véső

RO Daltă de tâmplărie
FR Ciseaux à bois
IT Scalpello per falegname
ES Cincel para madera
CN 木工凿

HRC 58-60 CrV 60



YATO	Size / Rozmiar [mm]	
YT-6241	8	10/60
YT-6242	10	10/60
YT-6243	12	10/60
YT-6244	14	10/60
YT-6245	15	10/60
YT-6246	16	10/60
YT-6247	18	10/60

YATO	Size / Rozmiar [mm]	
YT-6248	20	10/60
YT-6249	22	10/60
YT-6251	25	10/60
YT-6253	28	10/60
YT-6256	35	10/60
YT-6258	38	10/60

EN Ball pein hammer
PL Młotek blacharski
DE Ausbeulhammer
RU Молоток рихтовочный

CZ Klempířské kladívko
HU Bádógos kalapács
RO Ciocan pt. tabla
FR Marteau à panne ronde

IT Martello per lamiera
ES Martillo de hojalatero
CN 胡桃木柄圆头锤

WOODEN HANDLE DREWNIANA REKOWIEC



YATO	m [g]	L [mm]	A [mm]	H [mm]	
YT-4519	225	295	26	80	6/36
YT-4520	450	335	35	100	6/24
YT-4521	680	360	36	115	6/12
YT-4522	900	380	40	125	6/12

EN Geological hammer
PL Młotek geologiczny
DE Geologenhammer
RU Геологический молоток
CZ Geologické kladívo
HU Geológuskalapács
RO Ciocan geologic
FR Marteau de géologue
IT Martello da geologo
ES Martillo de geólogo
CN 地质锤

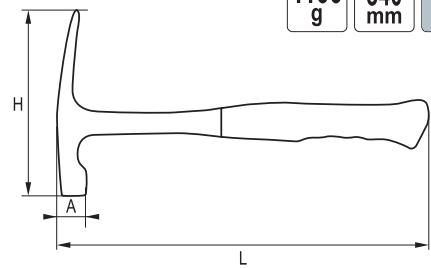

1100 g 340 mm



YATO	m [g]	L [mm]	A [mm]	H [mm]	
YT-45655	1010	340	23x23	190	6/18

EN Half-round wood chisel
PL Dłuto półokrągłe do drewna
DE Meißel für Holz halbrund
RU Полуокруглый зубило по дереву
CZ Půlkulaté dláto do dřeva
HU Félkör alakú favéső

RO Daltă semicirculară
FR Ciseau à bois semi-circulaire
IT Scalpello semicircolare per legno
ES Cincel semicircular para madera
CN 半圆木凿

#55



YATO	Size / Rozmiar [mm]	
YT-62821	10	12/48
YT-62822	12	12/48
YT-62823	14	12/48
YT-62824	16	12/48
YT-62825	19	12/48
YT-62826	25	12/48
YT-62827	32	12/48
YT-62828	38	12/48

EN Wood chisel set
 PL Zestaw dłut stolarskich
 DE Stechbeitelsatz
 RU Набор стамесок по дереву
 CZ Sada tesářských dlát
 HU Asztalos véső készlet

RO Set dălți de tâmplărie
 FR Jeu de ciseaux à bois
 IT Set scalpelli da falegname
 ES Juego de cinceles para madera
 CN 木凿组套

4 PCS 10 mm 16 mm 20 mm
 25 mm HRC 58-60 CrV 60



YATO	Size / Rozmiar [mm]	
YT-6260	10, 16, 20, 25	5/20

EN Wood chisel set
 PL Zestaw dłut stolarskich
 DE Stechbeitelsatz
 RU Набор стамесок по дереву
 CZ Sada tesářských dlát
 HU Asztalos véső készlet
 RO Set dălți de tâmplărie
 FR Jeu de ciseaux à bois
 IT Set scalpelli da falegname
 ES Juego de cinceles para madera
 CN 木凿组套

4 PCS 10, 12 16, 20 mm CrV



YATO	Size / Rozmiar [mm]	
YT-6281	10, 12, 16, 20	6/24

EN Cold chisel with protection
 PL Przecinak z osłoną
 DE Schlitzmeißel mit Handschutz
 RU Зубило с протектором
 CZ Ploché sekáč (z krytem)
 HU Hidegvágó, lapos (védőfejjel)
 RO Daltă - tăietor plată (cu apărătoare)
 FR Burin
 IT Scalpello con protezione
 ES Cincel plano (con protector)
 CN 石工凿

25x300 mm CrV



YATO	L [mm]	
YT-4700	300	4/24

EN Cold chisel
 PL Przecinak płaski
 DE Flachmeißel
 RU Зубило плоское
 CZ Sekáč plochý
 HU Laposvágó

RO Daltă lata
 FR Burin plat
 IT Scalpello piatto
 ES Tajadera en frío
 CN 扁铲

CrV 6150



YATO	L [mm]	Chisel width / Szerokosc przecinaka [mm]	
YT-47147	142	10.0	20/120
YT-47148	152	12.5	20/120
YT-47149	172	16.0	20/120

EN Wood chisel set
 PL Zestaw dłut stolarskich
 DE Stechbeitelsatz
 RU Набор стамесок по дереву
 CZ Sada tesářských dlát
 HU Asztalos véső készlet

RO Set dălți de tâmplărie
 FR Jeu de ciseaux à bois
 IT Set scalpelli da falegname
 ES Juego de cinceles para madera
 CN 木凿组套

3 PCS 16 mm 25 mm 32 mm
 CrV



YATO	Size / Rozmiar [mm]	
YT-6280	16, 25, 32	10/30

EN Corner chisel
 PL Dłuto kątowe
 DE Eckmeißel
 RU Угловая стамеска
 CZ Rohové dláto
 HU Sarokvéső
 RO Daltă pt. colturi
 FR Ciseau d'angle
 IT Scalpello angolare
 ES Cincel de esquina
 CN 较链定位器

9x9 mm 90°



YATO	Size / Rozmiar [mm]	
YT-62840	9x9	10/100

EN Chisel and punch set
 PL Zestaw przecinaków i punktaków
 DE Trennmeißel- und Durchtreiber-Satz
 RU Зубила и пробойники с протектором
 CZ Sekáče a průbojníky
 HU Véső és lyukasztó készlet
 RO Set dalti de impact
 FR Kit de burins et perçoirs
 IT Scalpelli e bulino
 ES Juego de cinceles de acero templado y punzones
 CN 冲凿组套

6 PCS 180 mm CrV



YATO	L [mm]	
YT-4710	180	10/20

EN Cold chisel
 PL Przecinak płaski
 DE Flachmeißel
 RU Зубило плоское
 CZ Sekáč plochý
 HU Laposvágó

RO Daltă lata
 FR Burin plat
 IT Scalpello piatto
 ES Tajadera en frío
 CN 扁铲

40Cr



YATO	L [mm]	Chisel width / Szerokosc przecinaka [mm]	
YT-47020	200	20	10/40
YT-47021	250	22	10/40
YT-47022	300	25	10/40

EN Taper punch
 PL Wybijak stożkowy
 DE Durchtreiber
 RU Пробойник конусный

CZ Průbojník
 HU Lyukasztó
 RO Dorn conic
 FR Percuteur

IT Scalpello a punta
 ES Retacador de cono
 CN 锥形冲子



YATO	L [mm]	Pin diameter / Średnica grotu [mm]	
YT-47141	150	1.5	20/120
YT-47142	150	3.0	20/120
YT-47143	150	4.0	20/120
YT-47144	150	5.0	20/120
YT-47145	150	6.0	20/120
YT-47146	150	8.0	20/120

EN Center punch
 PL Punktak
 DE Kömer
 RU Керн
 CZ Důlčák
 HU Pontozó

RO Punctator
 FR Pointeau
 IT Punzoni
 ES Punzón centrador
 CN 冲子

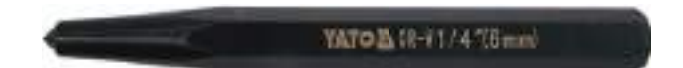

YATO	L [mm]	Center punch / Średnica punktaka [mm]	
YT-47150	100	6	20/120
YT-47151	112	8	20/120

EN Nail punch set
 PL Zestaw dobijaków do gwoździ
 DE Nagelstanzer-Set
 RU Доби́йники для гвоздей

CZ Sada děrovačů hřebíků
 HU Szögbeverő készlet
 RO Set dornuri ascuțite
 FR Ensemble de chasse-clous
 IT Set di punzoni per chiodi
 ES Juego de retacadores para puntillas
 CN 钉子冲



3 PCS
 150 mm
 CrV 6150

Ø 0.8, 1.6, 2.4 mm

YATO	
YT-47155	10/60

EN Brass pin punch set
 PL Zestaw wybijaków równoległych mosiężnych
 DE Splintentreiber Satz aus Messing
 RU Набор выколоток латунных

CZ Sada děrovačů rovnoběžných mosazných
 HU Párhuzamos tűskéjú réz csapszegkiütő készlet
 RO Set poanson din alama
 FR Ensemble de poinçons parallèles en laiton
 IT Set di punzoni a spillo tondi
 ES Juego de punzones de latón
 CN 冲凿



Ø 1.5, 2.3, 3.2, 3.9, 4.7, 5.5, 6.3, 7.8 mm (L=90 mm)

YATO	L [mm]	
YT-47124	90	50

EN Taper punch
 PL Dobijak stożkowy
 DE Durchtreiber
 RU Пробойник конусный
 CZ Průbojník
 HU Szögbeverő

RO Dorn conic
 FR Chasse-clous conique
 IT Scalpello a punta
 ES Retacador de cono
 CN 冲子



YATO	L [mm]	Taper punch / Średnica wybijaka stożkowego [mm]	
YT-47152	140	2	20/120

EN Center punch set
 PL Zestaw punktaków
 DE Zentrierkömer Satz
 RU Набор кернов
 CZ Sada důlčáků
 HU Pontozó készlet
 RO Set punctatoare
 FR Ensemble de poinçons
 IT Set di punzoni
 ES Juego de punzones centradores
 CN 冲凿



7 PCS
 CrV 6150
 HARDENED STEEL STAL HARTOWANA

Ø 1.5 x 100 mm, Ø 2 x 100 mm, Ø 2.5 x 100 mm, Ø 3 x 106 mm, Ø 4 x 110 mm, Ø 5 x 125 mm, Ø 6 x 140 mm

YATO	
YT-47170	60

EN Pin punch set
 PL Zestaw wybijaków
 DE Splintentreiber Satz
 RU Пробойник булавочный - набор

CZ Sada vyrážečů
 HU Csapszegkiütő készlet
 RO Set de dornuri
 FR Set de perceuteurs
 IT Set di punzoni
 ES Juego de punzones
 CN 锥形冲子组套



6 PCS
 150 mm
 CrV 6150

Ø 1.5, 3.0, 4.0, 5.0, 6.0, 8.0 mm

YATO	L [mm]	
YT-47121	150	6/24

EN Roll pin punch set
 PL Zestaw wybijaków równoległych kulistych
 DE Splintentreiber Satz
 RU Набор выколоток

CZ Sada děrovačů rovnoběžných kulatých
 HU Párhuzamos tűskéjú, kerek csapszegkiütő készlet
 RO Set dornuri
 FR Ensemble de poinçons parallèles à billes
 IT Set di punzoni a spillo tondi
 ES Juego de punzones redondos
 CN 冲凿



9 PCS
 STEEL STAL

Ø 1.7 x 70 mm, 2.0 x 82 mm, 2.5 x 92 mm, 3.2 x 100 mm, 3.9 x 115 mm, 5.0 x 120 mm, 5.8 x 128 mm, 6.6 x 140 mm, 8.0 x 160 mm

YATO	
YT-47123	63/36

- EN Pin punch set
- PL Zestaw wybijaaków
- DE Splintentreiber Satz
- RU Пробойник булавочный - набор
- CZ Sada vyražeců
- HU Csapszegkiütő készlet
- RO Set de dornuri
- FR Set de perceuteurs
- IT Set di punzoni
- ES Juego de punzones
- CN 销式冲子组套



21
PCS

BRASS
MOSIADZ

STEEL
STAL

YATO

YT-4712

20

- EN Chisel set
- PL Zestaw przecinaków
- DE Flachmeisselsatz
- RU Зубила в наборе
- CZ Sekáče
- HU Hidegvágó
- RO Set dalti zidarie
- FR Set de burins
- IT Set scalpelli
- ES Cinceles
- CN 冲凿组套

3
PCS

CrV



YATO

YT-4711

6/24

- EN Mini cold chisel and punch set
- PL Zestaw wybijaaków i przecinak
- DE Trennmeissel- und Durchtreiber-Satz
- RU Зубила и керны в наборе
- CZ Sekáče a průbojníky
- HU Véső és lyukasztó készlet
- RO Set dalti de impact
- FR Set de burins et perceuteurs mini
- IT Set scalpelli e bullini
- ES Juego de cinceles de acero templado y punzones
- CN 迷你冲凿组套

3
PCS

125
mm

CrV



YATO

YT-4713

10/60

- EN Pin punch
- PL Wybijaak
- DE Splintentreiber
- RU Пробойник булавочный
- CZ Vyražec
- HU Csapszegkiütő
- RO Dorn cilindric
- FR Percuteur
- IT Punzoni
- ES Punzón expulsador
- CN 销式冲子

Ø **3.8**
mm

150
mm

CrV
60



YATO

YT-4690

L [mm]

150

20/120

- EN Chisel and punch set
- PL Zestaw przecinaków i punktaków
- DE Trennmeissel- und Durchtreiber-Satz
- RU Зубила, керны и пробойники в наборе
- CZ Sekáče a průbojníky
- HU Véső és lyukasztó készlet
- RO Set dalti de impact
- FR Set de burins et pointeaux
- IT Set scalpelli
- ES Juego de cinceles de acero templado y punzones
- CN 冲凿组套

6
PCS

CrV



YATO

YT-4712

6/24

- EN Chisel and punch set
- PL Zestaw przecinaków i punktaków
- DE Trennmeissel- und Durchtreiber-Satz
- RU Зубила, керны и пробойники в наборе
- CZ Sekáče a průbojníky
- HU Véső és lyukasztó készlet
- RO Set dalti de impact
- FR Set de burins et pointeaux
- IT Set scalpelli
- ES Juego de cinceles de acero templado y punzones
- CN 冲凿组套

12
PCS

CrV



YATO

YT-4714

10/20

- EN Taper punch
- PL Dobiaak stożkowy
- DE Durchtreiber
- RU Пробойник конусный
- CZ Průbojník
- HU Szögbeverő
- RO Dorn conic
- FR Chasse-clous conique
- IT Punzoni
- ES Retacador de cono
- CN 冲孔器

Ø **3.3**
mm

120
mm

CrV
60



YATO

YT-4691

L [mm]

120

20/120

EN Center punch RO Punctator
PL Punktak FR Pointeau
DE Kömer IT Punzoni
RU Керн ES Punzón centrador
CZ Důlčák CN 冲子
HU Pontozó

3.8 mm 120 mm CrV 60



Ø 3.8 mm

YATO	L [mm]	
YT-4692	120	20/120

EN Cold chisel RO Dalta lata
PL Przecinak płaski FR Burin plat
DE Flach Meissel IT Scalpello piatto
RU Зубило плоское ES Tajadera en frío
CZ Sekáč plochy CN 扁铲
HU Laposvágó

12 mm 130 mm CrV 60



12 mm

YATO	L [mm]	
YT-4693	130	20/120

EN Cape chisel RO Dalta ascutita
PL Przecinak krzyżowy FR Burin
DE Kreuzmeissel IT Scalpello rettangolare
RU Зубило „липка” ES Tajadera rectangular
CZ Sekáč křížový CN 铲头
HU Keresztvágó

5.5 mm 130 mm CrV 60



5.5 mm

YATO	L [mm]	
YT-4694	130	20/120

EN Hexagonal wrecking bar RO Ranga pt. scos cuie
PL Łom sześciokątny FR Pied-de-biche manche hexagonal
DE Brechstange IT Mazza di ferro
RU Лом-гвоздодёр шестигранный ES Palanca hexagonal
CZ Šestiúhľe páčidlo CN 撬棒
HU Hatszögű feszítővas

DROP FORGED KUTE



YATO	L [mm]	W [mm]	
YT-46800	400	18	6/12
YT-46801	450	18	6/12
YT-46802	600	18	6/12
YT-46803	750	18	6/12
YT-46804	900	18	5/10

EN Profiled wrecking bar RO Ranga pt. scos cuie
PL Łom profilowany FR Pied-de-biche profilé
DE Nagelisen IT Mazza di ferro
RU Лом-гвоздодёр ES Palanca perfilada
CZ Páčidlo CN 撬棒
HU Szögkihúzó

DROP FORGED KUTE



YATO	L [mm]	W [mm]	± [mm]	
YT-46810	350	22	13	1/12
YT-46811	450	30	17	6/12
YT-46812	600	30	17	4/8
YT-46813	750	30	17	8
YT-46814	900	30	17	3/6

EN Chisel and punch set
PL Zestaw przecinaków i punktaków
DE Trennmeissel- und Durchtreiber-Satz
RU Зубила и пробойники с протектором
CZ Sekáče a průbojníky
HU Véső és lyukasztó készlet
RO Set dalți de impact
FR Kit de burins et perçoirs
IT Scalpelli e bulino
ES Juego de cinceles de acero templado y punzones
CN 样冲组套

5 PCS CrV 60



12x130 mm;
5.5x130 mm;
Ø 3.8x150 mm;
Ø 3.3x120 mm;
3.8x120 mm

YATO	
YT-4695	6/24

EN Hexagonal wrecking bar RO Ranga pt. scos cuie
PL Łom sześciokątny FR Pied-de-biche manche hexagonal
DE Brechstange IT Mazza di ferro
RU Лом-гвоздодёр шестигранный ES Palanca hexagonal
CZ Šestiúhľe páčidlo CN 六角撬棒
HU Hatszögű feszítővas

DROP FORGED KUTE



YATO	L [mm]	W [mm]	
YT-46831	400	16	6/24
YT-46832	600	20	12
YT-46833	800	22	1/12
YT-46834	1000	22	6
YT-46835	1200	25	6
YT-46836	1500	25	6

EN Flat wrecking bar RO Ranga plata
PL Łom płaski FR Pied-de-biche plat
DE Nagelisen spitze IT Mazza di ferro
RU Лом плоский ES Palanca plana
CZ Páčidlo ploché CN 撬棒
HU Lapos feszítővas

DROP FORGED KUTE



YATO	L [mm]	W [mm]	± [mm]	
YT-46820	300	35	6	10/30
YT-46821	380	35	6	10/20
YT-46822	450	35	6	10/20
YT-46823	600	35	6	10/20

EN Precision claw bar
 PL Lom wąski
 DE Brechheisen
 RU Лом
 CZ Páčidlo
 HU Emelőrúd
 RO Rangă
 FR Pied de biche
 IT Piede di porco
 ES Palanca estrecha
 CN 撬棒



YATO	L [mm]	W [mm]	± [mm]	
YT-46750	300	16	13	6/24

EN Pry bar set
 PL Zestaw łomów
 DE Brechstangensatz
 RU Набор ломов
 CZ Sada páčidel
 HU Feszítővas készlet

RO Set leviere
 FR Jeu de barres à clous
 IT Set di piedi di porco
 ES Juego de palancas
 CN 撬棒



EN Pry bar set
 PL Zestaw łomów
 DE Brechstangensatz
 RU Набор ломов
 HU Feszítővas készlet

RO Set leviere
 FR Jeu de barres à clous
 IT Set di piedi di porco
 ES Juego de palancas
 CN 撬棒



YATO	
YT-47303	6

YATO	
YT-47304	6/12

EN Removal tool set
 PL Zestaw łomów
 DE Brechstangensatz
 RU Набор ломов
 CZ Sada páčidel
 HU Feszítővas készlet
 RO Set leviere
 FR Jeu de barres à clous
 IT Set di piedi di porco
 ES Juego de palancas
 CN 撬棒组套

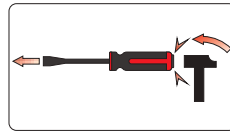

205x10x11 mm, 140 g; 310x15x16 mm, 295 g; 400x15x21 mm, 400 g

YATO	
YT-47301	4/16

EN Go-through pry bar set
 PL Zestaw łomów
 DE Nagel eisensatz
 RU Набор ломов
 CZ Sada mini páčidel
 HU Szóghúzó készlet

RO Set leviere
 FR Set de pieds-de-biche
 IT Set mazza di ferro
 ES Juego de palancas de hierro
 CN 穿心撬棒组套

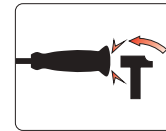

198x6x6 mm, 110 g; 304x10x10 mm, 292 g; 456x10x10 mm, 479 g; 608x12x12 mm, 745 g

YATO	
YT-4730	3/6

EN Axe
 PL Siekiera
 DE Axt
 RU Топор

CZ Sekera
 HU Fejsze
 RO Topor
 FR Hache

IT Ascia
 ES Hacha
 CN 把斧



YATO	m [g]	L [mm]	DIN	
YT-8001	600	360	5131	24
YT-8002	800	380	5131	20
YT-8003	1000	400	5131	12
YT-8004	1250	710	7294	12
YT-8005	1400	710	7294	12
YT-8006	1600	810	7294	12

EN Splitting axe
 PL Siekiera rozłupująca
 DE Spaltaxt
 RU Топор-копун

CZ Štipací sekera
 HU Hasítófejsze
 RO Topor pt. despicat lemne
 FR Hache à fendre

IT Ascia spaccalegna
 ES Hacha de corte
 CN 把斧



YATO	m [g]	L [mm]	
YT-8011	1000	430	6
YT-8012	2000	820	6

EN Axe
PL Siekiera
DE Axt
RU Топор
CZ Sekera
HU Fejsze

RO Topor
FR Hache
IT Ascia
ES Hacha
CN 把斧

500 g
230 mm
DIN 7287
HRC 47-55
NYLON



YATO	m [g]	L [mm]	
YT-80070	500	230	6/24

EN Axe
PL Siekiera
DE Axt
RU Топор
CZ Sekera
HU Fejsze

RO Topor
FR Hache
IT Ascia
ES Hacha
CN 把斧

DIN 7287
HRC 47-55
NYLON



YATO	m [g]	L [mm]	
YT-80071	700	360	6/24
YT-80072	900	450	6/12
YT-80073	1400	600	6

EN Splitting axe
PL Siekiera rozluźniająca
DE Spaltaxt
RU Топор-копун
CZ Štípač sekera
HU Hasítófejsze

RO Topor pt. despicat lemne
FR Hache à fendre
IT Ascia spaccalegna
ES Hacha de corte
CN 把斧

DIN 7287
HRC 47-55
NYLON



YATO	m [g]	L [mm]	
YT-80080	900	450	6/12
YT-80081	1600	600	6
YT-80082	1800	720	6

EN Adze flat type
PL Ciosło płaskie
DE Flachdaxel
RU Тесно плоское

CZ Sekyrka
HU Szekerce
RO Tesla
FR Hache d'artisans

IT Ascia tipo piatto
ES Destral de artesanos
CN 扁斧



YATO	
YT-80130	4/24

EN Long breaking bar with hook
PL Dźwignia z hakiem do odwracania pni
DE Fällheber
RU Рычаг для рубки
CZ Obrabeč kmene
HU A törzs csonkolója

RO Bara cu carlig pt. ridicat
FR Tourne-bille métal
IT Leva giratronchi
ES Palanca de tala
CN 翻木器

830 mm
DROP FORGED KUTE



YATO	L [mm]	
YT-79901	830	2/8

EN Lifting tongs
PL Kleszce do drewna
DE Handpackzange
RU Ручной клещевой захват для бревен
CZ Souběžné vynášeči kleště na dřevo
HU Emelőfogó
RO Clește pt. ridicare lemni
FR Pince de levage combinée
IT Pinza spostatronchi
ES Madera gancho de elevación
CN 抓钩

450 mm
300 mm



YATO	L [mm]	
YT-79904	450	6/24

EN Lifting tongs
PL Kleszce do drewna
DE Handpackzange
RU Ручной клещевой захват для бревен
CZ Souběžné vynášeči kleště na dřevo
HU Emelőfogó
RO Clește pt. ridicare lemni
FR Pince de levage combinée
IT Pinza spostatronchi
ES Madera gancho de elevación
CN 抓钩

330 mm
180 mm



YATO	L [mm]	
YT-79905	330	20

EN Lifting tongs
PL Kleszce do drewna
DE Handpackzange
RU Ручной клещевой захват для бревен
CZ Souběžné vynášeči kleště na dřevo
HU Emelőfogó
RO Clește pt. ridicare lemni
FR Pince de levage combinée
IT Pinza spostatronchi
ES Madera gancho de elevación
CN 长柄伐木钩

770 mm
275 mm



YATO	L [mm]	
YT-79907	770	6/12

EN Lifting hook
PL Hak z uchwytem do drewna
DE Holz-Hebehaken
RU Захватный крюк для бревен
CZ Hák na dřevo
HU Emelőhorog

RO Carlig pt. ridicare lemni
FR Pince de levage
IT Alzatronchi manuale
ES Madera gancho de elevación
CN 抓钩

265 mm



YATO	L [mm]	
YT-79910	265	30

EN Log lifting pick
PL Hak do wyciągania pni
DE Handsappie
RU Большой зацеп для бревен
CZ Sapie dřevorubecká - hák na klády
HU Fa mozgató csákány

RO Tapina usoara din aluminiu
FR Sappie à main en aluminium avec lame
IT Piccone spostatronchi
ES Zapa de aluminio
CN 铝柄抓钩

AI
ANTI-SLIP HANDLE
UCHWYT ANTY-POŚLIZGOWY



YATO	L [mm]	
YT-79915	580	12
YT-79916	720	12

- EN Saw trestle
- PL Koziół do pilowania drewna
- DE Kettensägesägebock
- RU Козлы металлические для распиловки бревен
- CZ Koza na řezání dřeva
- HU Fűrészbak
- RO Capră de metal pt. tăierea
- FR Chevalet de sciage pour bûches
- IT Cavalletto per segare la legna
- ES Caballete de corte para aserrar leña
- CN 锯齿锯架



920 x 1020 mm max 150kg ZINC PLATED OCYNKOWANA



YATO **YT-79925** 1

- EN Spiked felling wedge
- PL Klin do drewna z tworzywa
- DE Keil für Holz, Kunststoff
- RU Кли́н для дере́ва, пластик
- CZ Klín do dřeva, plast
- HU Ék fához, műanyag

- RO Pana
- FR Cale pour bois en plastique
- IT Cuneo spaccalegna, materia plastica
- ES Cuña para madera, de plástico
- CN 楔子



YATO	Dimensions / Wymiary [mm]	m [g]	
YT-79883	136x65x25	95	50/100
YT-79882	205x72x30	220	20/40
YT-79881	245x85x30	315	20/40
YT-79880	300x85x35	430	20/40

- EN Spiked felling wedge set
- PL Zestaw klinów
- DE Keile-Satz
- RU Набор клиньев
- HU Ékkészlet

- RO Set pene
- FR Jeu de cales
- IT Set di cunei
- ES Juego de cuñas
- CN 楔子

4
PCS



YATO **YT-79884** L [mm] 20
136, 205, 245, 300

- EN Wood splitter (knife)
- PL Ręczna łuparka do drewna
- DE Hand-Holzspalter
- RU Механический дровокол
- CZ Štěpačka na dřevo
- HU Fahasító

- RO Despicator de lemn
- FR Splitter outil pour fendre le petit bois
- IT Spaccalegna manuale
- ES Astilladora cortadora de lena manual
- CN 劈柴器



355x40 mm 680x8 mm

YATO **YT-79940** 4

- EN Foot-operated log splitter
- PL Nożna łuparka do drewna
- DE Fuß-Holzspalter
- RU Механический дровокол
- CZ Štěpačka na dřevo
- HU Fahasító

- RO Despicator de lemn
- FR Splitter outil pour fendre e petit bois
- IT Spaccalegna con azionamento a pedale
- ES Astilladora cortadora de lena
- CN 脚踏劈柴机



max 430x180 mm **1.2t**

YATO **YT-79943** 1

Memo

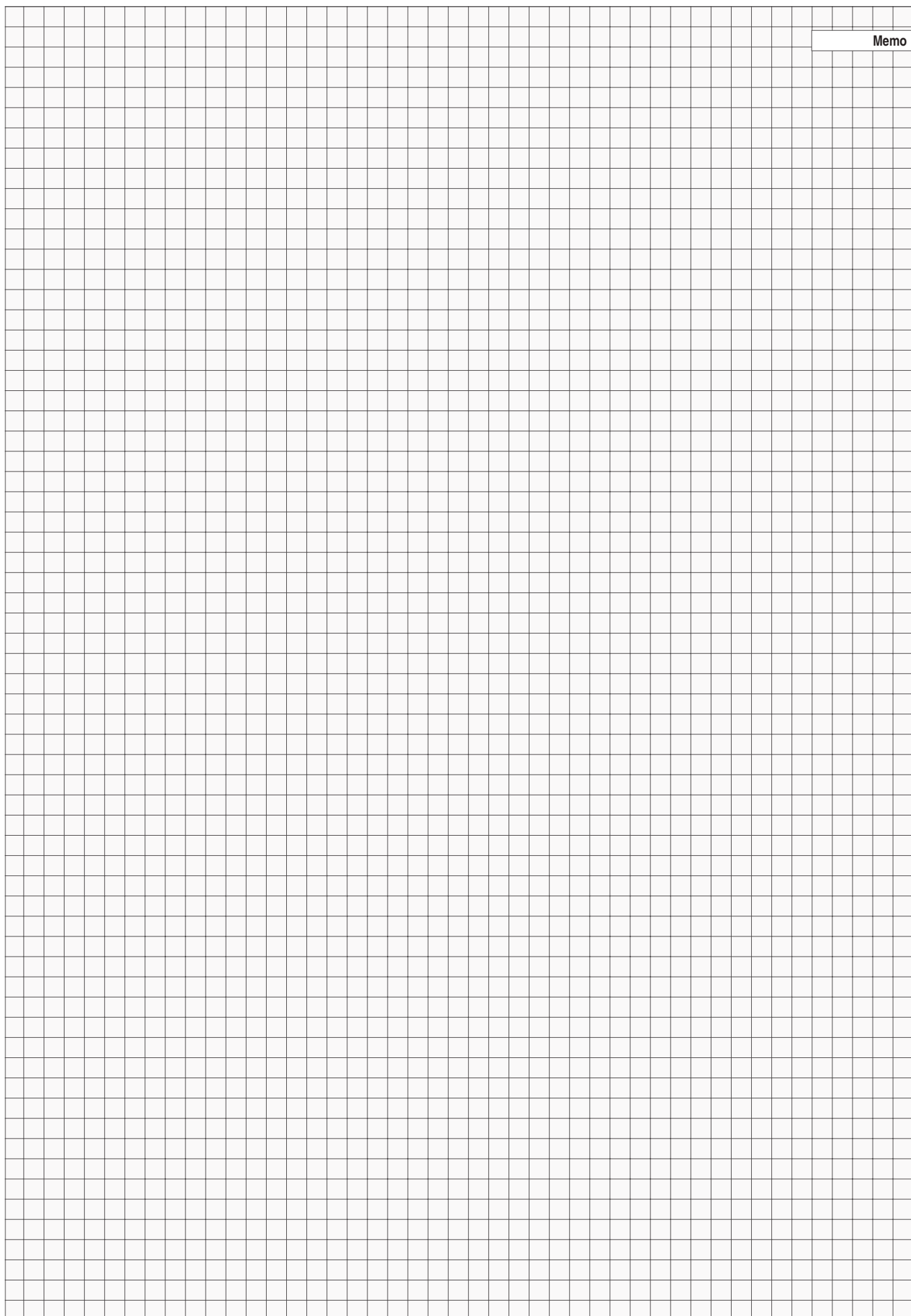

9

Clamps, vices & holders Ściski, imadła i wsporniki

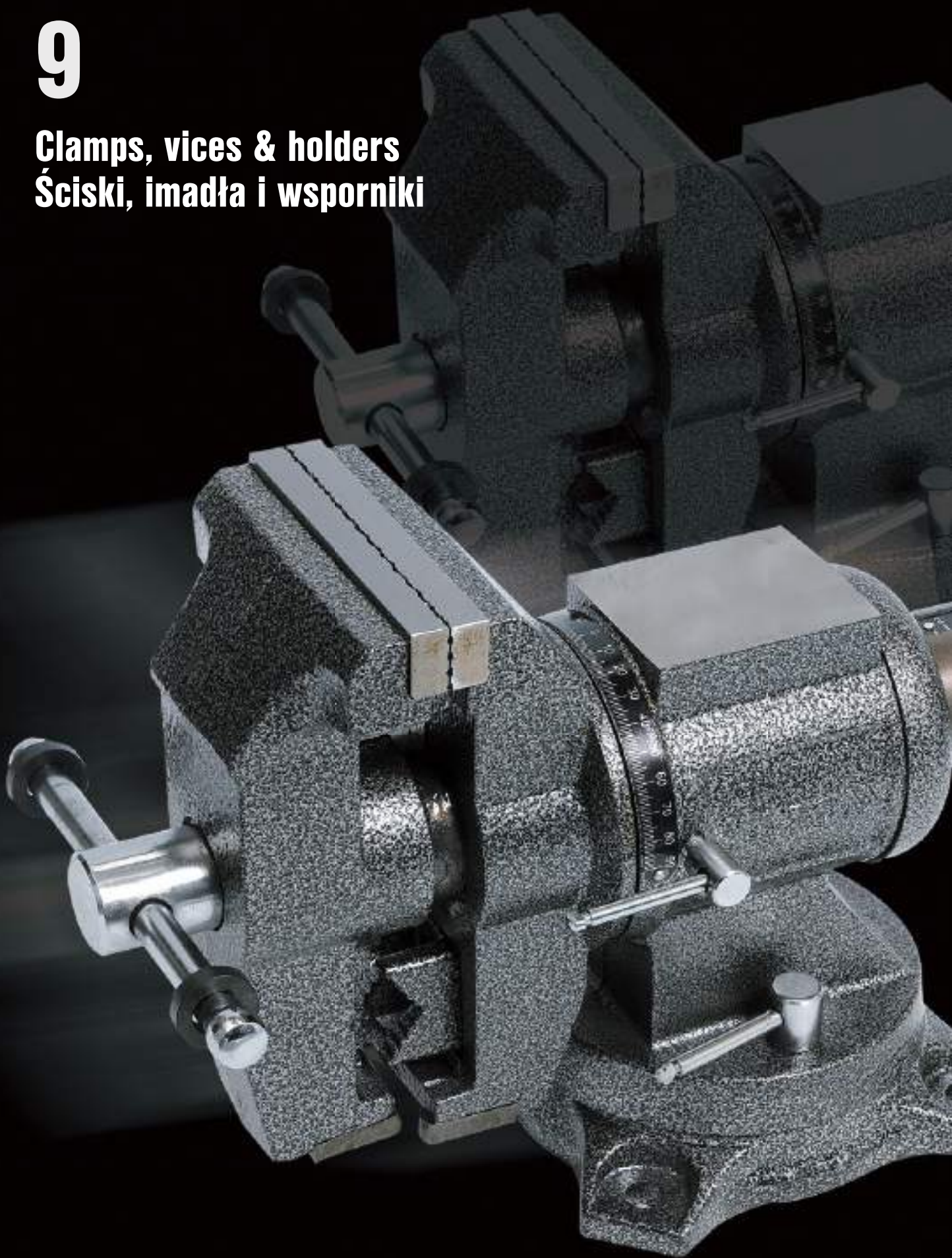

Clamps
Ściski



150-151

Vices
Imadła



152-153

- EN F-clamp
 PL Ścisk stolarski
 DE Schraubzwinge
 RU Струбцина
- CZ Truhlářské upínadlo
 HU Asztalos szorító
 RO Menghină pt. tâmplărie
 FR Presse à serrage pour menuisier

- IT Morsetto da falegname
 ES Tornillo de apriete
 CN 塑柄夹



YATO	[mm]	
YT-6401	160x80	10/30
YT-6402	200x80	10/30
YT-6403	250x80	10/30
YT-6404	300x80	10/30
YT-6405	450x80	10/20
YT-6406	600x80	10/20
YT-6407	400x120	10
YT-6408	500x120	10
YT-6409	600x120	10
YT-6410	900x120	5

YATO	[mm]	
YT-64111	250x80	4/24
YT-64112	300x80	4/24
YT-64113	450x80	4/24
YT-6412	300x120	10
YT-6413	400x120	10
YT-6414	500x120	5
YT-6415	600x120	5
YT-6416	900x120	5
YT-6417	1050x120	5

YATO	[mm]	
YT-6440	100x50	12/60
YT-6441	150x50	12/48
YT-6442	200x50	12/48
YT-6443	250x50	12/48
YT-6444	300x50	12/48
YT-6445	200x80	10/20
YT-6446	250x80	10/20
YT-6447	300x80	10/20
YT-6448	500x80	10/20
YT-6449	300x120	10
YT-6450	500x120	10
YT-6451	800x120	6
YT-6452	1000x120	6
YT-6453	1200x120	6
YT-6454	1500x120	6

- EN Bar clamp ratchet
 PL Ścisk stolarski zapadkowy
 DE Lenkerklemmung Ratsche
 RU Струбцина быстрофиксируемая
 CZ Svěrka s ráčnou
 HU Bár bilincs racsnis
 RO Presă tip „F” cu clichet
 FR Bar pince à cliquet
 IT Bar morsetto a cricchetto
 ES Barra de mordaza de trinquete
 CN F夹



YATO	[mm]	
YT-63951	200x100	2/12
YT-63952	250x100	2/12
YT-63953	300x100	2/12
YT-63954	400x100	2/6

YATO	[mm]	
YT-63955	500x120	2/4
YT-63956	600x120	2/4
YT-63957	800x120	2/4
YT-63958	1000x120	2

- EN Spring clamp
 PL Ścisk sprężynowy
 DE Federklemme
 RU Струбцина пружинная
 CZ Pružinová svěrka
 HU Rugós szorító
- RO Clește presă
 FR Pince à ressort
 IT Morsetto a molla
 ES Pinza de resorte
 CN 弹簧夹



- EN Spring clamp
 PL Ścisk sprężynowy
 DE Federklemme
 RU Струбцина пружинная
 CZ Pružinová svěrka
 HU Rugós szorító
- RO Clește presă
 FR Pince à ressort
 IT Morsetto a molla
 ES Pinza de resorte
 CN 弹簧夹



YATO	L [mm]	Max. jaws range / Maks. rozwarcie szczęk [mm]	Max. jaws depth / Maks. głębokość szczęk [mm]	
YT-64275	55	20	20	500/1000
YT-64276	100	25	25	48/96
YT-64277	150	50	50	24/48
YT-64278	230	90	90	8/16

- EN Spring clamp
 PL Ścisk sprężynowy
 DE Federklemme
 RU Струбцина пружинная
 CZ Pružinová svěrka
 HU Rugós szorító
- RO Clește presă
 FR Pince à ressort
 IT Morsetto a molla
 ES Pinza de resorte
 CN 弹簧夹



YATO	L [mm]	Max. jaws range / Maks. rozwarcie szczęk [mm]	Max. jaws depth / Maks. głębokość szczęk [mm]	
YT-64270	100	42	44	24/240
YT-64271	150	55	68	12/120
YT-64272	200	79	91	10/100

- EN Corner clamp set
 PL Zestaw ścisków kątowych sprężynowych
 DE Federbelastete Eckklemmen
 RU Набор струбцин угловых
 CZ Pružinové úhlové svorky
 HU Rugós sarokszorító
 RO Set de cleme de colț
 FR Pincés d'angle à ressort
 IT Set di morsetti angolari a molla
 ES Abrazaderas de ángulo con muelle
 CN 木工夹



YATO	
YT-64300	6/24

- EN Adjustable corner clamp
 PL Ścisk kątowy regulowany
 DE Einstellbare Winkelklemme
 RU Регулируемый угловой зажим
 CZ Nastavitelná rohová svorka
 HU Állítható sarokszorító
 RO Clemă de colț reglabilă
 FR Pince à angle réglable
 IT Morsetto angolare regolabile
 ES Abrazadera de ángulo ajustable
 CN 角度固定夹



YATO	
YT-64307	20/40

EN Guide rail clamp
PL Ścisk do szyn i prowadnic
DE Klemmzwinde für Führungsschiene
RU Зажим для рельсов
и направляющих
CZ Svěrka pro vodiči lišty
HU Vezetősín szorító
RO Clemă cu șină de ghidare
FR Pince pour rails de guidage
IT Morsetto per binario guida
ES Sargento para ralles y guías
CN 轨道夹



70x300
mm

11x5
mm



YATO	Size / Rozmiar [mm]	
YT-64320	300x70	6/36

EN C-Clamp
PL Ścisk typu „C”
DE C-Schraubzwinde
RU Струбцина типа „C”
CZ Svěrka tvaru „C”
HU Pillanatszorító
RO Menghina tip „C”
FR Serre-joint
IT Morsetto tipo „C”
ES Tornillo tipo „C”
CN C型夹



YATO	Jaws range / Rozstaw szczęk [mm]	Force pressure / Siła nacisku [kg]	
YT-64250	25	120	100
YT-64251	50	200	50
YT-64252	75	280	30
YT-64253	100	350	30
YT-64254	125	390	18
YT-64255	150	450	12
YT-64256	200	500	12
YT-64257	250	540	5
YT-64258	300	600	5

EN Quick release “C” clamp
PL Ścisk typu “C” z szybkim przesuwem śruby
DE C-Schraubzwinde mit schnellem Vorschub
RU Зажим типа “C” с быстрым перемещением винта
CZ Svorka typu “C” s rychlým posunem šroubu
HU “C” típusú szorító gyors csavareltolással
RO Clema tip “C” cu eliberare rapidă
FR Serre-joint en “C” à vis d’action rapide
IT Morsetto a rilascio rapido di tipo “C”
ES Pinza tipo “C” con desplazamiento rápido de tornillo
CN 快速C型夹



150x85
mm

6
kN



YATO	[mm]	Force pressure / Siła nacisku [kN]	
YT-64263	150x85	6	4/16

EN 3 way “C” clamp
PL Ścisk śrubowy potrójny
DE Dreiwegschraubzwinde
RU Тройной винтовой зажим
CZ Šroubová svorka trojitá
HU Triplás csavaros szorító
RO Clema tip “C” cu 3 prinderi
FR Presse à chant
IT Morsetto a vite triplo
ES Pinza de tornillo triple
CN 三头C型夹



62x62
mm



YATO	[mm]	
YT-64242	62x62	10/60

EN C-Clamp
PL Ścisk typu „C”
DE C-Schraubzwinde
RU Струбцина типа „C”
CZ Svěrka tvaru „C”
HU Pillanatszorító
RO Menghina tip „C”
FR Serre-joint
IT Morsetto tipo „C”
ES Tornillo tipo „C”
CN C型夹



DROP
FORGED
KUTE



YATO	Jaws range / Rozstaw szczęk [mm]	Force pressure / Siła nacisku [kg]	
YT-6420	50	1500	6/30
YT-6421	75	1950	6/18
YT-6422	100	2980	6/12
YT-6423	150	3200	6/12
YT-6424	200	3600	6

EN Quick release “C” clamp
PL Ścisk typu “C” z szybkim przesuwem śruby
DE C-Schraubzwinde mit schnellem Vorschub
RU Зажим типа “C” с быстрым перемещением винта
CZ Svorka typu “C” s rychlým posunem šroubu
HU “C” típusú szorító gyors csavareltolással
RO Clema tip “C” cu eliberare rapidă
FR Serre-joint en “C” à vis d’action rapide
IT Morsetto a rilascio rapido di tipo “C”
ES Pinza tipo “C” con desplazamiento rápido de tornillo
CN 快速C型夹



100x50
mm

5
kN



YATO	[mm]	Force pressure / Siła nacisku [kN]	
YT-64262	100x50	5	6/24

EN “C” clamp deep
PL Ścisk typu “C” głęboki
DE C-Schraubzwinde, tief
RU Зажим типа “C” глубокий
CZ Svorka typu “C” hluboká
HU “C” típusú mély szorító
RO Clema tip “C” adanca
FR Serre-joint en “C” à gorge profonde
IT Morsetto profondo di tipo “C”
ES Pinza tipo “C” profunda
CN C型夹



YATO	[mm]	Force pressure / Siła nacisku [kN]	
YT-64190	63x130	3	6/36
YT-64191	76x203	3	6/24
YT-64192	101x304	3	6/12

EN Nylon C-clamp
PL Ścisk typu “C” nylonowy
DE Klemmverschraubung Typ “C” aus Nylon
RU Зажим-струбцина тип “C” нейлоновый
CZ Svorka typu “C” nylonová
HU “C” típusú nylon asztalos szorító
RO Clema plastic tip “C”
FR Pince en “C” en nylon
IT Morsetto di tipo “C” in nylon
ES Sargento tipo “C” de nylon
CN 快速夹



NYLON



YATO	Jaws range / Rozstaw szczęk [mm]	
YT-64183	50	12/72
YT-64184	75	12/48

EN Swivel base bench vice
 PL Imadło ślusarskie obrotowe
 DE Drehbare Schraubstock
 RU Тиски слесарные поворотные
 CZ Zámečnický svěrák otáčivý
 HU Forgatható lakatos satu
 RO Menghină rotativă
 FR Étau rotatif de serrurier
 IT Morsa a cerniera
 ES Tornillo de apriete giratorio
 CN 重型台虎钳



EN Swivel base bench vice
 PL Imadło ślusarskie obrotowe
 DE Drehbare Schraubstock
 RU Тиски слесарные поворотные
 CZ Zámečnický svěrák otáčivý
 HU Forgatható lakatos satu
 RO Menghină rotativă
 FR Étau rotatif de serrurier
 IT Morsa a cerniera
 ES Tornillo de apriete giratorio
 CN 多功能台虎钳



• Anvil and changeable jaws made of hardened steel
 • Kowadzelko i wymienne szczęki z hartowanej stali

• Anvil and changeable jaws made of hardened steel
 • Kowadzelko i wymienne szczęki z hartowanej stali

YATO	Jaws width / Szerokość szczęk [mm]	m [kg]	
YT-6501	100	7	2
YT-6502	125	10	2
YT-6503	150	15	1
YT-65048	150	19	1
YT-6504	200	21	1
YT-65049	200	29.5	1

YATO	Jaws width / Szerokość szczęk [mm]	Jaws range / Rozstaw szczęk [mm]	m [kg]	
YT-6505	100	100	10	1

EN Swivel base bench vice
 PL Imadło ślusarskie obrotowe
 DE Drehbare Schraubstock
 RU Тиски слесарные поворотные
 CZ Zámečnický svěrák otáčivý
 HU Forgatható lakatos satu
 RO Menghină rotativă
 FR Étau rotatif de serrurier
 IT Morsa a cerniera
 ES Tornillo de apriete giratorio
 CN 多功能台虎钳

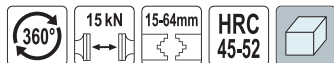

EN Hand vice
 PL Imadło ręczne
 DE Handschraubstock
 RU Ручные тиски
 CZ Ruční svěrák
 HU Kézi satu
 RO Menghină manuală
 FR Étau à main
 IT Morsa a mano
 ES Tornillo de banco manual
 CN 手用台钳





• Anvil and changeable jaws made of hardened steel
 • Kowadzelko i wymienne szczęki z hartowanej stali

YATO	Jaws width / Szerokość szczęk [mm]	Jaws range / Rozstaw szczęk [mm]	m [kg]	
YT-6506	125	125	20	1

YATO	Jaws range / Rozstaw szczęk [mm]	Jaws width / Szerokość szczęk [mm]	
YT-65080	25	25	8/48
YT-65081	27	40	6/36
YT-65082	32	50	4/24

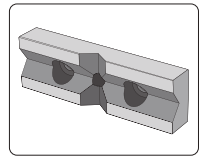
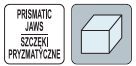

EN Drill vice
PL Imadło maszynowe
DE Maschinenschraubstock
RU Тиски машинные
CZ Svěrák pod vrtačku
HU Gépsatu
RO Menghină universală
FR Étau de perçage
IT Morsa per macchina
ES Tornillo de banco
CN 平口钳



YATO 	Jaws width / Szerokość szczęk [mm]	
YT-65071	50	10
YT-65072	100	6
YT-65073	150	2



EN Angle vice
PL Imadło kątowe
DE Winkelschraubstock
RU Угловые тиски
CZ Úhlový svěrák
HU Sarokszorító
RO Menghină pt. coltură
FR Étau angulaire
IT Morsa angolare
ES Tornillo de banco angular
CN 木工角夹



YATO 	Jaws range / Rozstaw szczęk [mm]	
YT-65136	70	20

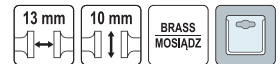

EN Hand vice
PL Imadło ręczne
DE Handschraubstock
RU Ручные тиски
CZ Ruční svěrák
HU Kézi satu
RO Menghină manuală
FR Étau à main
IT Morsetto a mano
ES Tornillo de banco manual
CN 手用台钳



YATO 	Jaws range / Rozstaw szczęk [mm]	Jaws width / Szerokość szczęk [mm]	
YT-65085	13	10	12/48



EN Soft vice jaws
PL Miękkie szczęki wymienne do imadła
DE Weiche austauschbare Schraubstock-Schutzbacken
RU Мягкие сменные губки для тисков
CZ Měkké čelisti do svěráku
HU Puha csere pófák satuhoz
RO Protecție bacuri menghină
FR Mors de protection souples remplaçables pour étaux
IT Ganasce morbide intercambiabili per morsa
ES Mordazas blandas sustituibles para el tornillo de banco
CN 磁性钳口保护套



YATO 	Dimensions / Wymiary [mm]	
YT-65000	75x30x10	20/60
YT-65001	100x30x10	20/60
YT-65002	125x30x10	20/60
YT-65003	150x30x10	20/60

EN Exchangeable vice jaws set
PL Szczęki wymienne do imadła
DE Backen für Schraubstöcke
RU Сменные губки для тисков
CZ Výměnné čelisti do svěráku
HU Satu pót befogó pófák
RO Bacuri de protecție din aluminiu pt. menghină
FR Mâchoires remplaçables pour vices
IT Ganasce intercambiabili per morsa
ES Mordazas sustituibles para el tornillo de banco
CN 台钳保护夹



YATO 	L [mm]	
YT-65006	100	20
YT-65007	125	20
YT-65008	150	20

10

Cutting tools Narzędzia tnące



Drills Wiertła		Circular dies Narzynki	178
157-169		Step drills Wiertła stopniowe	179
Twist drill bits HSS & sets Wiertła do metalu HSS i zestawy	157	Taper drill sets Zestawy wiertel stożkowych	179
Double end metal twist drills Wiertła do metalu dwustronne	158	Countersinks & sets Pogłębiacze i zestawy	179
Twist drill bits HSS-E Co & sets Wiertła do metalu HSS-E Co i zestawy	158	Tap wrenches & die holders Pokręta do gwintowników i narzynek	180
Twist drill bits HSS-TiN & sets Wiertła do metalu HSS-TiN i zestawy	159	Plug and forstner cutters & sets Flekowniki-sękwowniki do drewna i zestawy	180
Universal drills & sets Wiertła uniwersalne i zestawy	162	Router bits, rotary rasps & sets Frezy do drewna, metalu i zestawy	181-185
SDS masonry drill bits X-TIP Wiertła do betonu SDS, z grotem krzyżowym	163	Diamond tools Narzędzia diamentowe	186-187
SDS masonry drill bits Wiertła do betonu SDS	164	Diamond blades for cutting construction materials Tarcze diamentowe do cięcia materiałów budowlanych	186
Masonry drill bits with cylindrical shank & sets Wiertła do betonu z uchwytem cylindrycznym i zestawy	165	Diamond grinding cup wheels Diamentowe talerze szlifierskie do betonu i kamienia	187
Flat wood drill bits & sets Wiertła łopatkowe do drewna i zestawy	165	Diamond core drill bits Diamentowe wiertła koronowe	187
Spur wood drill bits Wiertła do drewna spiralne	166	Diamond blades for cutting construction materials Tarcze diamentowe do cięcia materiałów budowlanych	186
Auger wood drill bits & sets Świdry do drewna i zestawy	166	Diamond grinding cup wheels Diamentowe talerze szlifierskie do betonu i kamienia	187
Confirmat screw drill bits Wiertła do konfirmatów	168	Diamond core drill bits Diamentowe wiertła koronowe	187
Drills for glass, ceramic tiles & sets Wiertła do szkła, ceramiki, gresu i zestawy	168	Adjustable hand reamers Rozwiertaki nastawne	169
Drilling accessories Akcesoria do wiercenia	168	Tungsten carbide tipped tools Narzędzia z ostrzem z węgliku wolframu	188-189
Tools for dowel joints Narzędzia do połączeń kołkowych	169-170	Tungsten carbide saws for wood Tarcze z węglikiem do drewna	188
SDS Chisels Przecinaki i dłuta SDS	171-173	Tungsten carbide saws for steel & aluminium Tarcze z węglikiem do stali i aluminium	189
Hollow drill sets Wiertła koronowe do betonu	174	PVC cutting discs Tarcze do cięcia PCV	189
Hole saws Otwornice	174-176	Cutting & grinding discs Tarcze do cięcia i szlifowania	190-192
Universal hole saws Otwornice uniwersalne	174	Stainless steel cutting discs Tarcze do cięcia stali nierdzewnej	190
Bi-metal hole saws Otwornice bimetalowe	174	Metal cutting discs Tarcze do cięcia metalu	190
Arbors for hole saws Uchwyty do otwornic	175	Metal grinding discs Tarcze do szlifowania metalu	190
Hole saw kits Zestawy otwornic	176	Stone cutting discs Tarcze do cięcia kamienia	191
Taps & dies Narzędzia do gwintowania	177-180	Stone grinding discs Tarcze do szlifowania kamienia	191
Hand taps & sets Gwintowniki i zestawy	177	Plate discs with hook fastener Tarcze z rzepem	191
		Cutting & grinding rasp discs Tarcze tarnikowe do cięcia i szlifowania	191



Shears Nożyce			Squeegees Rakle	217
	193-198		Scissors Nożyczki	217
Tin snips Nożyce do blachy	193		Marking out tools Narzędzia traserskie	217
Steel strap cutters Nożyce do cięcia taśm stalowych	196		Punch sets Przebijaki do skóry	219
Bolt cutters Nożyce do prętów	196		Scrapers Skrobaki i cykliny	220
Hydraulic cutters & accessories Nożyce z silownikiem hydraulicznym i akcesoria	197		Planes Strugi	221
Multifunctional scissors Nożyce wielofunkcyjne	198		Steel files & sets Pilniki do metalu i zestawy	222
			Needle file sets Zestawy pilników iglaków	223
			Diamond needle files & sets Pilniki iglaki diamentowe i zestawy	223
Saws & blades Piły i brzeszczoty	193-198		Diamond whetstones Osełki diamentowe	225
			Rasps & sets Tarniki do drewna i zestawy	225
Hand saws Piły do drewna	198		Rasps for plaster Tarniki do gipsu	225
Back saws for PVC Piły do PCV	198		Abrasive products Artykuły ściernie	226-232
Drywall saws Piły do płyt gipsowo-kartonowych	198			
Bow saws Piły kabłąkowe	199		Sand papers Papiery ściernie	226
Blades Brzeszczoty	200		Waterproof sand papers Papiery ściernie wodoodporne	226
Hacksaw frames Piły do metalu	200		Abrasive clothes Płótna ściernie	227
Blades Brzeszczoty	200		Abrasive meshes Siatki ściernie	227
Jig saw blades Brzeszczoty do wyrzynarek	202		No end abrasive bands Taśmy ściernie bezkońcowe	227
Accessories for multi-purpose oscillating tools Akcesoria do wielofunkcyjnych narzędzi oscylacyjnych	204		Abrasive sponges Kostki ściernie	228
			Abrasive sheets and discs Arkusze i krążki ściernie	229
Brushes, knives & files Szczotki, noże i pilniki	209-225		Back pads for drywall sander Głowice do szlifierki do gipsu	232
			Polishing products Artykuły polerskie	232-234
Wire brushes & sets Szczotki druciane i zestawy	209			
Cup brushes Szczotki tarczowe	210			
Electric screwdriver accessories Akcesoria do wkrętarek	213			
Knives & blades Noże i ostrza	214			

EN Twist drill HSS
PL Wiertło do metalu HSS
DE Metallspiralbohrer HSS
RU Цебно no meranny HSS
CZ Vrták na kov HSS
HU Fúrószár fémhez HSS

RO Burghiu pt. metal HSS
FR Foret métal HSS
IT Punta per metallo HSS
ES Broca para metal HSS
CN 轧制麻花钻

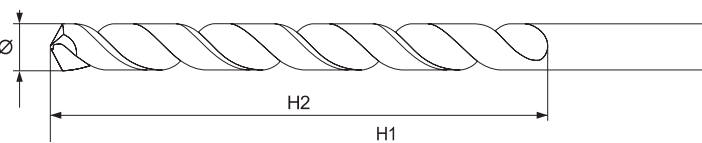
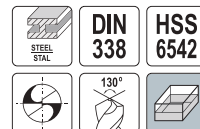

• Application: industry
• For precise drilling in steels, cast steels, non-ferrous metals, plastics

• Przeznaczenie: przemysł
• Do precyzyjnych wierceń w stalach, żeliwach, metalach nieżelaznych, tworzywach sztucznych

YATO	Ø [mm]	H1 [mm]	H2 [mm]	α [min ⁻¹]	pcs / szt.	Box
YT-4430	1.0	34	23	3800	10	80/320
YT-4431	1.5	43	20	3800	10	80/320
YT-4432	2.0	49	24	4000	10	80/320
YT-4433	2.5	57	30	3200	10	80/320
YT-4434	2.8	61	33	2800	10	80/320
YT-4435	3.0	61	33	2600	10	80/320
YT-4436	3.2	65	36	2500	10	80/320
YT-4437	3.5	70	39	2300	10	80/320
YT-4438	4.0	75	43	2000	10	80/320
YT-4439	4.2	75	43	1900	10	20/80

YATO	Ø [mm]	H1 [mm]	H2 [mm]	α [min ⁻¹]	pcs / szt.	Box
YT-4440	4.5	80	47	1800	10	20/80
YT-4441	4.8	86	52	1600	10	20/80
YT-4442	5.0	86	52	1600	10	20/80
YT-4443	5.2	86	52	1500	10	20/80
YT-4444	5.5	93	57	1500	10	20/80
YT-4445	6.0	93	57	1300	10	20/80
YT-4446	6.5	101	63	1200	10	10/40
YT-4447	7.0	109	69	1100	10	10/40
YT-4448	7.5	109	69	1100	10	10/40
YT-4449	8.0	117	75	1000	10	10/40

YATO	Ø [mm]	H1 [mm]	H2 [mm]	α [min ⁻¹]	pcs / szt.	Box
YT-4450	8.5	117	75	900	5	10/40
YT-4451	9.0	125	81	900	5	10/40
YT-4452	9.5	125	81	800	5	10/40
YT-4453	10.0	133	87	800	5	10/40
YT-4454	10.5	133	87	800	3	10/40
YT-4455	11.0	142	94	700	3	10/40
YT-4456	12.0	151	101	700	3	10/40
YT-4457	12.5	151	101	600	3	10/40
YT-4458	13.0	151	101	600	3	10/40

EN Twist drill set
PL Komplet wiertel do metalu
DE Metallspiralbohrersatz

RU Набор цебно no meranny
CZ Souprava vrtákú na kov
HU Fúrószárkészlet fémhez

RO Set de burghie pt. metal
FR Set des forets métal HSS
IT Set punte per metallo

ES Broca para metal
CN 轧制麻花钻组套



6
PCS

Ø
2.0-8.0
mm

YATO	Ø [mm]	Box
YT-4460	2, 3, 4, 5, 6, 8	15/60



10
PCS

Ø
1.0-10
mm

YATO	Ø [mm]	Box
YT-4461	1, 2, 3, 4, 5, 6, 7, 8, 9, 10	20/40

19
PCS

Ø
1.0-10
mm

YATO	Ø [mm]	Box
YT-4462	1, 1.5, 2, 2.5, 3, 3.5, 4, 4.5, 5, 5.5, 6, 6.5, 7, 7.5, 8, 8.5, 9, 9.5, 10	15/30

EN Twist drill HSS
PL Wiertło do metalu HSS
DE Metallspiralbohrer HSS
RU Цебно no meranny HSS
CZ Vrták na kov HSS
HU Fúrószár fémhez HSS

RO Burghiu pt. metal HSS
FR Foret métal HSS
IT Punta per metallo HSS
ES Broca para metal HSS
CN 磨制麻花钻

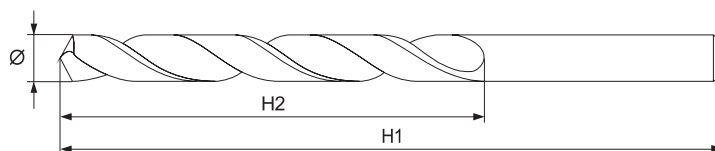

YATO	Ø [mm]	H1 [mm]	H2 [mm]	pcs / szt.	Box
YT-44200	0.5	22	6	5	100/400
YT-44201	0.8	30	10	5	100/400
YT-44202	1.0	34	11	5	100/400
YT-44203	1.5	40	18	5	100/400
YT-44204	2.0	48	22	5	100/400
YT-44205	2.2	53	28	5	50/400
YT-44206	2.4	56	30	5	100/400
YT-44207	2.5	57	30	5	100/400
YT-44208	2.8	62	30	5	100/400
YT-44209	3.0	61	34	1	100/400
YT-44210	3.1	65	35	1	100/400
YT-44211	3.2	65	35	1	100/400
YT-44212	3.5	70	40	1	100/400
YT-44213	3.8	77	48	1	100/400

YATO	Ø [mm]	H1 [mm]	H2 [mm]	pcs / szt.	Box
YT-44214	4.0	74	44	1	100/400
YT-44215	4.1	75	44	1	100/400
YT-44216	4.2	75	45	1	100/400
YT-44217	4.5	79	45	1	100/400
YT-44218	4.8	85	51	1	100/400
YT-44219	5.0	86	52	1	100/400
YT-44220	5.2	86	52	1	100/400
YT-44221	5.5	92	56	1	100/400
YT-44222	6.0	93	56	1	100/400
YT-44223	6.5	100	63	1	100/400
YT-44224	7.0	103	64	1	50/300
YT-44225	7.5	108	70	1	50/300
YT-44226	8.0	115	75	1	50/300
YT-44227	8.5	115	73	1	50/300

YATO	Ø [mm]	H1 [mm]	H2 [mm]	pcs / szt.	Box
YT-44228	9.0	125	81	1	50/300
YT-44229	9.5	125	82	1	50/300
YT-44230	10.0	133	87	1	50/200
YT-44231	10.2	130	85	1	50/200
YT-44232	10.5	132	82	1	50/200
YT-44233	11.0	142	95	1	50/200
YT-44234	11.5	142	95	1	50/150
YT-44235	12.0	150	100	1	50/150
YT-44236	12.5	150	100	1	50/150
YT-44237	13.0	150	100	1	50/150
YT-44238	14.0	160	110	1	25/100
YT-44239	16.0	176	122	1	25/100
YT-44240	20.0	205	140	1	25/50

- EN Double end metal twist drill
- PL Wiertło do metalu dwustronne
- DE Metallbohrer, doppelseitig
- RU Двухстороннее сверло по металлу
- CZ Vrták do kovu dvoustranný
- HU Kétoldalas fém fúrószár
- RO Set burghie metal, capat dublu
- FR Foret pour métal à double extrémité
- IT Punta doppia per metallo
- ES Broca para metal doble
- CN 双头全磨制麻花钻

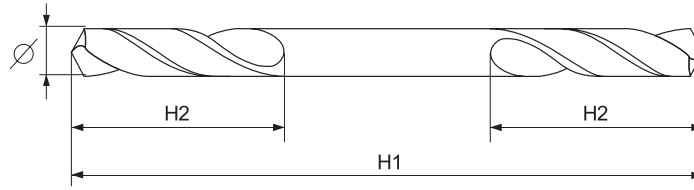

YATO	Ø [mm]	H1 [mm]	H2 [mm]	Box
YT-40010	3.0	46	9.5	100/500
YT-40011	3.2	49	9.5	100/500
YT-40012	3.5	52	13	100/500
YT-40013	4.0	55	13	100/500
YT-40014	4.2	55	13	100/500

YATO	Ø [mm]	H1 [mm]	H2 [mm]	Box
YT-40015	4.5	58	16	100/500
YT-40016	5.0	62	16	100/500
YT-40017	5.2	62	16	100/500
YT-40018	5.5	66	16	50/500
YT-40019	6.0	66	16	50/500

- EN Double end metal twist drill set
- PL Zeslaw dwustronnych wiertel do metalu
- DE Satz von doppelseitigen Bohrem für Metall
- RU Набор двухсторонних сверл по металлу
- CZ Sada oboustranných vrtáků do kovu
- HU Kétoldalas fémfúró szár készlet
- RO Set burghie metal cu cap dublu
- FR Ensemble de forets pour métaux à deux côtés
- IT Set di punte a doppia estremità per metallo
- ES Juego de brocas de doble punta para metal
- CN 双头钻组套



YATO	Ø [mm]	Box
YT-40025	3.0, 3.2, 3.5, 4.0, 4.2, 4.5, 5.0, 5.2, 5.5, 6.0	10/240

- EN Twist drill HSS-Cobalt
- PL Wiertło do metalu HSS-Cobalt
- DE Metallschraubbohrer HSS-Cobalt
- RU Сверло по металлу HSS-Cobalt
- CZ Vrták na kov HSS-Cobalt
- HU Fúrószár fémhez HSS-Cobalt
- RO Burghiu pt. metal HSS-Cobalt
- FR Foret métal HSS-Cobalt
- IT Punta per metallo HSS-Cobalt
- ES Broca para metal HSS-Cobalt
- CN 全磨制含钴麻花钻

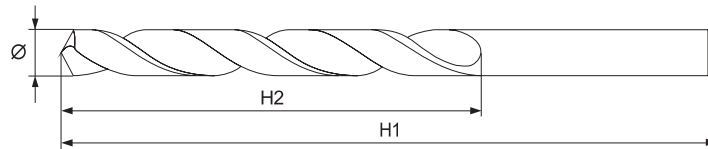

- Application: industry
- For precise drilling in hard steels, non-ferrous metals, plastics, stainless steel and acid resistant steel
- Resistant to high temperatures
- Przeznaczenie: przemysł
- Do precyzyjnych wierceń w trudnych materiałach, np. stalach szlachetnych, metalach kolorowych, tworzywach, stalach nierdzewnych i kwasoodpornych
- Odporne na działanie wysokiej temperatury

YATO	Ø [mm]	H1 [mm]	H2 [mm]	pcs / szt.	Box
YT-4020	2.0	49	24	2	125/500
YT-4025	2.5	57	30	2	125/500
YT-4030	3.0	61	33	2	125/500
YT-4032	3.2	65	36	1	100/400
YT-4035	3.5	70	39	1	100/400
YT-4040	4.0	75	43	1	100/400
YT-4042	4.2	75	43	1	100/400
YT-4045	4.5	80	47	1	100/400
YT-4048	4.8	86	52	1	100/400
YT-4050	5.0	86	52	1	100/400
YT-4052	5.2	86	52	1	100/400
YT-4055	5.5	93	57	1	100/400

YATO	Ø [mm]	H1 [mm]	H2 [mm]	pcs / szt.	Box
YT-4060	6.0	93	57	1	100/400
YT-4065	6.5	101	63	1	75/300
YT-4070	7.0	109	69	1	75/300
YT-4075	7.5	109	69	1	75/300
YT-4080	8.0	117	75	1	75/300
YT-4085	8.5	117	75	1	75/300
YT-4090	9.0	125	81	1	75/300
YT-4100	10.0	133	87	1	75/300
YT-4110	11.0	142	94	1	75/300
YT-4120	12.0	151	101	1	75/300
YT-4140	14.0	160	108	1	25/100
YT-4160	16.0	178	120	1	25/100

EN Twist drill set
PL Komplet wiertel do metalu
DE Metallschraubbohrersatz
RU Набор сверл по металлу
CZ Souprava vrtáků na kov
HU Fúrószárkészlet fémhez
RO Set de burghie pt. metal
FR Set des forets métal HSS
IT Set punte per metallo
ES Broca para metal
CN 全磨制含钴麻花钻组套

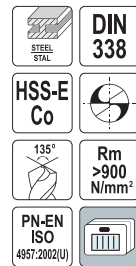

6
PCS
∅
2.0-8.0
mm

10
PCS
∅
1.0-10
mm

YATO	∅ [mm]	
YT-41602	2, 3, 4, 5, 6, 8	15/60

YATO	∅ [mm]	
YT-41603	1, 2, 3, 4, 5, 6, 7, 8, 9, 10	20/40



19
PCS
∅
1.0-10
mm

25
PCS
∅
1.0-13
mm

YATO	∅ [mm]	
YT-41604	1, 1.5, 2, 2.5, 3, 3.5, 4, 4.5, 5, 5.5, 6, 6.5, 7, 7.5, 8, 8.5, 9, 9.5, 10	15/30

YATO	∅ [mm]	
YT-41605	1, 1.5, 2, 2.5, 3, 3.5, 4, 4.5, 5, 5.5, 6, 6.5, 7, 7.5, 8, 8.5, 9, 9.5, 10, 10.5, 11, 11.5, 12, 12.5, 13	10

EN Twist drill
PL Wiertło do metalu
DE Metallschraubbohrer
RU Сверло по металлу
CZ Vrták na kov
HU Fúrószár fémhez
RO Burghiu pt. metal
FR Foret métal
IT Punte per metallo
ES Broca para metal
CN 全磨制麻花钻

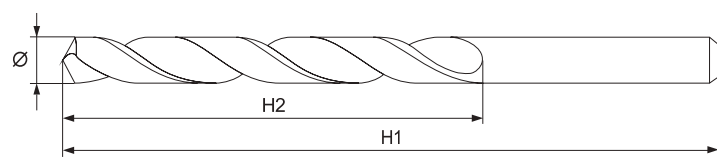

YATO	∅ [mm]	H1 [mm]	H2 [mm]	pcs / szt.	
YT-44630	1.0	34	12	2	50/500
YT-44631	1.5	40	18	2	50/500
YT-44632	2.0	49	24	2	50/500
YT-44633	2.5	57	30	2	50/500
YT-44634	2.8	61	33	2	50/500
YT-44635	3.0	61	33	2	50/500
YT-44637	3.2	65	36	1	50/500
YT-44639	3.5	70	39	1	50/500
YT-44640	4.0	75	43	1	50/500
YT-44642	4.2	75	43	1	50/500

YATO	∅ [mm]	H1 [mm]	H2 [mm]	pcs / szt.	
YT-44643	4.5	80	47	1	50/500
YT-44645	4.8	86	52	1	50/500
YT-44650	5.0	86	52	1	50/500
YT-44652	5.2	86	52	1	50/500
YT-44653	5.5	93	57	1	50/500
YT-44654	6.0	93	57	1	50/500
YT-44655	6.5	101	63	1	50/250
YT-44656	7.0	109	69	1	50/250
YT-44657	7.5	109	69	1	50/250
YT-44658	8.0	117	75	1	50/250

YATO	∅ [mm]	H1 [mm]	H2 [mm]	pcs / szt.	
YT-44659	8.5	117	75	1	50/250
YT-44660	9.0	125	81	1	50/250
YT-44661	9.5	125	81	1	50/250
YT-44662	10.0	133	87	1	50/200
YT-44663	10.5	133	87	1	50/200
YT-44664	11.0	142	94	1	50/200
YT-44666	12.0	151	101	1	50/100
YT-44667	12.5	151	101	1	50/100
YT-44668	13.0	151	101	1	50/100

- EN Twist drill set
 PL Komplet wiertel do metalu
 DE Metallspiralbohrersatz
 RU Набор сверл по металлу
 CZ Souprava vrtáků na kov
 HU Fúrószárkészlet fémhez
- RO Set de burghie pt. metal
 FR Set de forets métal
 IT Set punte per metallo
 ES Juego de brocas para metal
 CN 轧制麻花钻

190
PCS

DIN 338

HSS 4241

STEEL
STEEL

1.0-13
mm

TITANIUM
COATED
POWŁOKA
TYTANOWA

135°



- EN Long metal drills
 PL Długie wiertła do metalu
 DE Lange Bohrer für Metall
 RU Длинные сверла по металлу
 CZ Dlouhé vrtáky do kovu
 HU Hosszú fémfúrószárak
- RO Burghie lungi pt. metal
 FR Longs forets à métaux
 IT Punte lunghe per metallo
 ES Brocas largas para metal
 CN 加长麻花钻组套

5
PCS

DIN 1869

HSS 4341

STEEL
STEEL

FULLY
GROUND
WIERTŁO
SZLIFOWANE

118°



YATO	Ø [mm]	5
YT-44677	1, 1.5, 2, 2.5, 3, 3.2, 3.5, 4, 4.2, 4.5, 5, 5.5, 6, 6.5, 7, 7.5, 8, 8.5, 9, 9.5, 10, 10.5, 11, 11.5, 12, 12.5, 13	

YATO	Ø [mm]	20/80
YT-39820	3, 4, 5, 6, 8	

- EN Twist drill
 PL Wiertło do metalu
 DE Metallspiralbohrer
 RU Сверло по металлу
 CZ Vrták na kov
 HU Fúrószár fémhez
- RO Burghiu pt. metal
 FR Foret métal
 IT Punte per metallo
 ES Broca para metal
 CN 全磨制含钴麻花钻

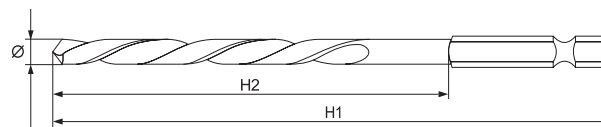

STEEL
STEEL

1/4"
6.3 mm

TITANIUM
COATED
POWŁOKA
TYTANOWA

DIN 338

HSS 4241

YATO	Ø [mm]	H1 [mm]	H2 [mm]	pcs / szt.	5
YT-44750	1.5	63	18	1	150/600
YT-44751	2.0	72	24	1	150/600
YT-44752	2.5	80	30	1	150/600
YT-44754	3.0	81	33	1	150/600
YT-44755	3.2	85	36	1	150/600
YT-44756	3.5	90	39	1	150/600
YT-44757	4.0	95	43	1	150/600
YT-44758	4.2	95	43	1	100/400

YATO	Ø [mm]	H1 [mm]	H2 [mm]	pcs / szt.	5
YT-44759	4.5	100	47	1	150/600
YT-44760	4.8	106	52	1	100/400
YT-44761	5.0	106	52	1	100/400
YT-44763	5.5	113	57	1	100/400
YT-44764	6.0	113	57	1	100/400
YT-44765	6.5	121	63	1	100/400
YT-44766	7.0	109	69	1	100/400
YT-44767	7.5	109	69	1	100/400

YATO	Ø [mm]	H1 [mm]	H2 [mm]	pcs / szt.	5
YT-44768	8.0	117	75	1	100/400
YT-44769	8.5	117	75	1	100/400
YT-44770	9.0	125	81	1	50/200
YT-44772	10.0	133	87	1	50/200
YT-44773	11.0	142	94	1	50/200
YT-44774	12.0	151	101	1	50/200
YT-44776	13.0	151	101	1	50/200

- EN Twist drill
 PL Wiertło do metalu
 DE Spiralbohrer
 RU Сверло по металлу
 CZ Vrták na kov
 HU Fúrószár fémhez
- RO Burghiu pt. metal
 FR Foret hélicoïdal
 IT Punte per metallo
 ES Broca espiral
 CN 整体六角柄全磨钻

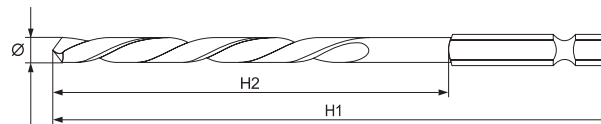

STEEL
STEEL

1/4"
6.3 mm

DIN 338

HSS 6542

135°

FULLY
GROUND
WIERTŁO
SZLIFOWANE

YATO	Ø [mm]	H1 [mm]	H2 [mm]	pcs / szt.	5
YT-44860	1.5	57	26	1	100/500
YT-44861	2.0	57	26	1	100/500
YT-44863	3.0	61	31	1	100/500
YT-44864	3.2	65	34	1	100/500
YT-44865	3.5	70	38	1	100/500
YT-44866	4.0	75	43	1	100/500
YT-44867	4.2	75	43	1	50/300
YT-44868	4.5	80	47	1	50/200

YATO	Ø [mm]	H1 [mm]	H2 [mm]	pcs / szt.	5
YT-44869	4.8	86	52	1	50/200
YT-44870	5.0	86	52	1	50/200
YT-44871	5.5	93	57	1	50/200
YT-44872	6.0	93	57	1	50/200
YT-44873	6.5	101	63	1	50/200
YT-44874	7.0	109	69	1	50/200
YT-44875	7.5	109	69	1	50/200
YT-44876	8.0	117	75	1	50/200

YATO	Ø [mm]	H1 [mm]	H2 [mm]	pcs / szt.	5
YT-44877	8.5	117	75	1	50/200
YT-44878	9.0	125	81	1	50/200
YT-44879	9.5	125	81	1	50/200
YT-44880	10.0	133	87	1	50/200
YT-44881	10.5	133	87	1	50/100
YT-44882	11.0	142	94	1	50/100
YT-44883	12.0	151	101	1	50/100
YT-44884	13.0	151	101	1	50/100

- EN Saw drill
 PL Wiertło frezujące do metalu
 DE Metall-Fräsböhrer
 RU Сверло фрезервальное по металлу
 CZ Vrták frézovací
 HU Marófúró fémhez
- RO Burghiu freza
 FR Foret de fraisage
 IT Punta per fresatura metalli
 ES Broca de sierra
 CN 整体六角柄锯钻

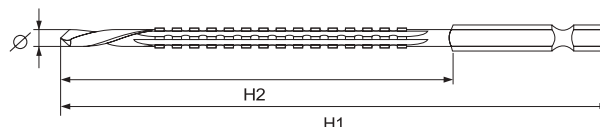

STEEL
STEEL

1/4"
6.3 mm

118°

TITANIUM
COATED
POWŁOKA
TYTANOWA

HRC 58-62

HSS 4241

YATO	Ø [mm]	H1 [mm]	H2 [mm]	pcs / szt.	5
YT-44820	3.0	70	35	1	150/600
YT-44821	4.0	78	43	1	100/300
YT-44822	5.0	81	46	1	100/400
YT-44823	6.0	89	54	1	100/400

YATO	Ø [mm]	H1 [mm]	H2 [mm]	pcs / szt.	5
YT-44824	6.5	89	54	1	100/400
YT-44826	8.0	99	64	1	100/400
YT-44827	9.0	102	67	1	50/200
YT-44828	10.0	105	70	1	50/200

YATO	Ø [mm]	H1 [mm]	H2 [mm]	pcs / szt.	5
YT-44829	11.0	110	75	1	50/200
YT-44830	12.0	115	80	1	50/200
YT-44831	13.0	120	85	1	50/200

EN Twist drill set
PL Komplet wiertel do metalu
DE Metallspiralbohrersatz
RU Набор сверл по металлу
CZ Souprava vrtáků na kov
HU Fúrószárkészlet fémhez
RO Set de burghie pt. metal
FR Set de forets métal
IT Set punte per metallo
ES Juego de brocas para metal
CN 麻花钻组套

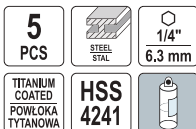

YATO	Ø [mm]	
YT-44700	4, 5, 6, 8, 10	30/60

EN Twist drill set
PL Komplet wiertel do metalu
DE Metallspiralbohrersatz
RU Набор сверл по металлу
CZ Souprava vrtáků na kov
HU Fúrószárkészlet fémhez
RO Set de burghie pt. metal
FR Set de forets métal
IT Set punte per metallo
ES Juego de brocas para metal
CN 麻花钻组套

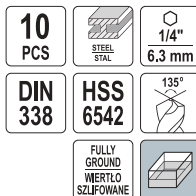

YATO	Ø [mm]	
YT-44888	1.5, 2.0, 2.5, 3.0, 3.5, 4.0, 4.5, 5.0, 5.5, 6.0	10/20

EN Twist drill set
PL Komplet wiertel do metalu
DE Metallspiralbohrersatz
RU Набор сверл по металлу
CZ Souprava vrtáků na kov
HU Fúrószárkészlet fémhez
RO Set de burghie pt. metal
FR Set de forets métal
IT Set punte per metallo
ES Juego de brocas para metal
CN 六角柄宝塔钻头薄板钻组套

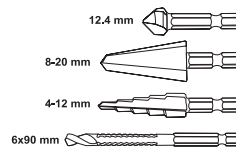
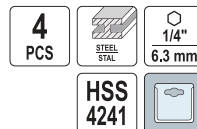

YATO	Ø [mm]	
YT-44705		12/24

EN Twist drill set
PL Komplet wiertel do metalu
DE Metallspiralbohrersatz
RU Набор сверл по металлу

CZ Souprava vrtáků na kov
HU Fúrószárkészlet fémhez
RO Set de burghie pt. metal
FR Set des forets métal HSS

IT Set punte per metallo
ES Broca para metal
CN 全磨制麻花钻

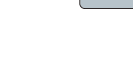

10

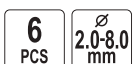

YATO	Ø [mm]	
YT-44673	2, 3, 4, 5, 6, 8	50/100



YATO	Ø [mm]	
YT-44674	1, 2, 3, 4, 5, 6, 7, 8, 9, 10	25/100



YATO	Ø [mm]	
YT-44675	1, 1.5, 2, 2.5, 3, 3.5, 4, 4.5, 5, 5.5, 6, 6.5, 7, 7.5, 8, 8.5, 9, 9.5, 10	6/30

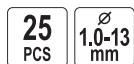

YATO	Ø [mm]	
YT-44676	1, 1.5, 2, 2.5, 3, 3.5, 4, 4.5, 5, 5.5, 6, 6.5, 7, 7.5, 8, 8.5, 9, 9.5, 10, 10.5, 11, 11.5, 12, 12.5, 13	5/20

EN Twist drill set
 PL Komplet wiertel do metalu
 DE Metallspiralbohrersatz
 RU Набор сверл по металлу
 CZ Souprava vrtáků na kov
 HU Fúrószerkészlet fémhez
 RO Set de burghie pt. metal
 FR Foret métaux
 IT Set punte per metallo
 ES Broca para metalo
 CN 轧制麻花钻



2 PCS
 ∅ 26, 28 mm

YATO	∅ [mm]	
YT-44627	26, 28	10



3 PCS
 ∅ 22, 24, 25 mm

YATO	∅ [mm]	
YT-44626	22, 24, 25	10



4 PCS
 ∅ 14-20 mm

YATO	∅ [mm]	
YT-44625	14, 16, 18, 20	10



5 PCS
 ∅ 10-15 mm

YATO	∅ [mm]	
YT-44622	10, 11, 12, 13, 15	10

EN Twist drill set
 PL Komplet wiertel do metalu
 DE Metallspiralbohrersatz
 RU Набор сверл по металлу
 CZ Souprava vrtáků na kov
 HU Fúrószerkészlet fémhez
 RO Set de burghie pt. metal
 FR Set de forets métal
 IT Set punte per metallo
 ES Juego de brocas para metal
 CN 轧制麻花钻

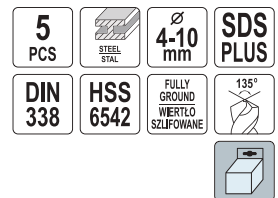

YATO	∅ [mm]	
YT-40050	4, 5, 6, 8, 10	24

EN Universal drill
 PL Wiertło uniwersalne
 DE Universalbohrer
 RU Универсальное сверло
 CZ Víceúčelový vrták
 HU Kőzet és többcéli fúró
 RO Burghiu universal cu coada hexagonala
 FR Forets polyvalents
 IT Punta universale
 ES Broca multmaterial
 CN 多功能冲击钻

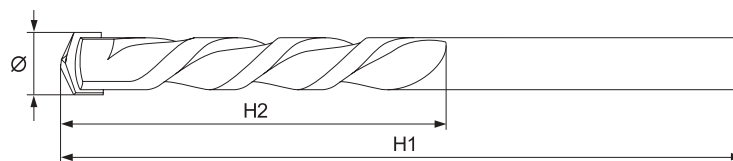
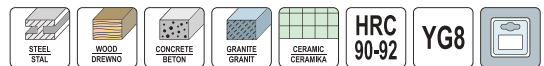

YATO	∅ [mm]	H1 [mm]	H2 [mm]	pcs / szt.	
YT-43940	3	60	35	1	100/600
YT-43941	4	75	40	1	100/600
YT-43942	5	85	50	1	100/600
YT-43943	6	100	60	1	100/400
YT-43960	6	400	240	1	25/100
YT-43944	7	100	60	1	100/400
YT-43945	8	120	70	1	50/400
YT-43962	8	400	240	1	25/100
YT-43946	10	150	90	1	50/200

YATO	∅ [mm]	H1 [mm]	H2 [mm]	pcs / szt.	
YT-43963	10	400	240	1	25/100
YT-43947	12	150	90	1	50/200
YT-43964	12	400	240	1	25/100
YT-43948	14	150	90	1	50/100
YT-43965	14	400	240	1	25/50
YT-43949	16	150	90	1	50/100
YT-43966	16	400	240	1	25/50
YT-43967	18	400	240	1	25
YT-43968	20	400	240	1	25

EN Universal drill
PL Wiertło uniwersalne
DE Universalbohrer
RU Универсальное сверло
CZ Víceúčelový vrták
HU Kőzet és többcéli fúró
RO Burghiu universal cu coada hexagonala
FR Forets polyvalents
IT Punta universale
ES Broca multimatierial
CN 六角柄多功能钻

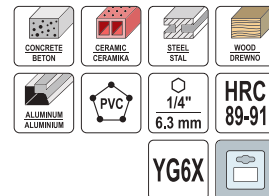
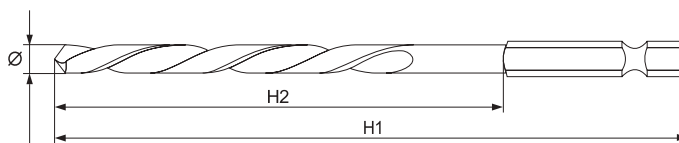

YATO	Ø [mm]	H1 [mm]	H2 [mm]	pcs / szt.	
YT-44780	3	85	30	1	125/250
YT-44781	4	85	30	1	125/250
YT-44782	5	85	30	1	125/250
YT-44783	6	85	30	1	125/250

YATO	Ø [mm]	H1 [mm]	H2 [mm]	pcs / szt.	
YT-44784	7	85	30	1	125/250
YT-44785	8	100	45	1	50/200
YT-44786	10	120	70	1	50/200
YT-44787	12	120	70	1	100/200

EN Universal drills
PL Zestaw wiertel uniwersalnych
DE Universalbohrer-Set
RU Набор универсальных сверл
CZ Sada víceúčelový vrtáky
HU Keményfém többcéli fúró készlet
RO Set burghie universale
FR Jeu de forets universel
IT Set di punte universali
ES Juego de brocas universales
CN 六角柄多功能钻组套

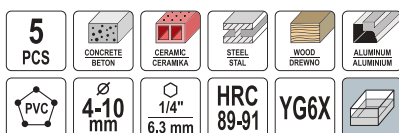

YATO	Ø [mm]	
YT-44789	4, 5, 6, 8, 10	25/100

EN Universal drill bit set
PL Zestaw wiertel uniwersalnych
DE Universalbohrer-Set
RU Набор универсальных сверл
CZ Sada víceúčelový vrtáky
HU Keményfém többcéli fúró készlet
RO Set burghie universale
FR Jeu de forets universel
IT Set di punte universali
ES Juego de brocas universales
CN 混合钻组套

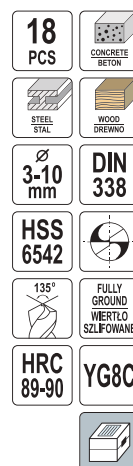

YATO	Ø [mm]	
YT-43490	3, 4, 5, 6, 8, 10	20

EN Masonry drill bit X-TIP
PL Wiertło do betonu X-TIP
DE Betonspiralbohrer X-TIP
RU Сверло по бетону X-TIP
CZ Vrták na beton X-TIP
HU Fúrószerű betonhoz X-TIP
RO Burghiu pt. beton X-TIP
FR Foret béton à pointe en croix
IT Punta per cemento X-TIP
ES Broca para hormigón X-TIP
CN 十字电锤钻

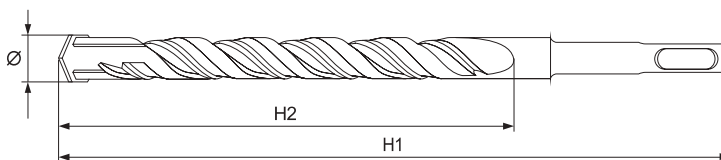

YATO	Ø [mm]	H1 [mm]	H2 [mm]	PCS ROZM.	
YT-4200	5	110	45	10	300
YT-4201	6	110	45	10	300
YT-4202	6	160	95	10	200
YT-4203	6	210	135	10	150
YT-42033	6	300	220	-	10/100
YT-4204	8	110	45	10	300
YT-4205	8	160	95	10	200
YT-4206	8	210	140	10	150
YT-42063	8	300	220	-	10/100
YT-4207	8	460	370	10	50
YT-4208	8	600	500	10	50
YT-4209	10	160	95	10	150
YT-4210	10	210	140	10	150
YT-4211	10	300	220	10	100
YT-4212	10	460	370	10	50
YT-4213	10	600	500	10	50
YT-4214	12	160	95	10	150

YATO	Ø [mm]	H1 [mm]	H2 [mm]	PCS ROZM.	
YT-4215	12	260	185	10	100
YT-42153	12	300	220	-	10/100
YT-4216	12	460	360	10	50
YT-4217	12	600	490	10	40
YT-4218	14	260	180	10	80
YT-4219	14	460	360	10	40
YT-4220	16	200	125	10	60
YT-4221	16	460	360	10	20
YT-4222	16	600	490	10	20
YT-4223	18	460	360	10	20
YT-4224	18	600	490	10	20
YT-4225	20	460	360	5	20
YT-4226	20	600	490	5	20
YT-4227	22	460	360	5	20
YT-4228	22	600	490	5	20
YT-4229	25	460	360	5	20
YT-4230	25	600	490	5	10

EN Masonry drill bit
 PL Wiertło do betonu
 DE Betonspiralbohrer
 RU Цебрно no бетоны
 CZ Vrták na beton
 HU Fúrószár betonhoz
 RO Burghiu pt. beton
 FR Foret béton
 IT Punta per cemento
 ES Broca para hormigón
 CN 三尖电锤钻

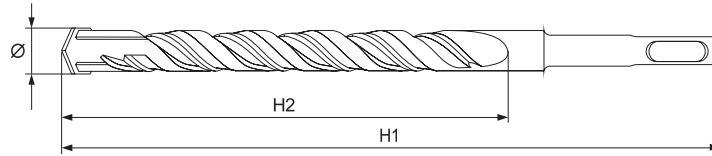

YATO	Ø [mm]	H1 [mm]	H2 [mm]	PCS PER BOX	
YT-4161	5	110	45	10	300
YT-4162	6	110	45	10	300
YT-4163	6	160	95	10	200
YT-4164	6	210	140	10	150
YT-4165	8	110	45	10	300
YT-4166	8	160	90	10	200
YT-4167	8	210	140	10	150
YT-4168	8	460	370	10	50
YT-4169	8	600	500	10	50
YT-4170	10	160	95	10	150
YT-4171	10	210	140	10	150
YT-4172	10	300	220	10	100
YT-4173	10	460	370	10	50
YT-4174	10	600	500	10	50
YT-4175	12	160	85	10	150
YT-4176	12	260	180	10	100

YATO	Ø [mm]	H1 [mm]	H2 [mm]	PCS PER BOX	
YT-4177	12	460	360	10	50
YT-4178	12	600	490	10	40
YT-4179	14	260	180	10	80
YT-4180	14	460	360	10	40
YT-4181	16	200	125	10	60
YT-4182	16	300	220	10	50
YT-4183	16	460	360	10	20
YT-4184	16	600	490	10	20
YT-4185	18	460	360	10	20
YT-4186	18	600	490	10	20
YT-4187	20	460	360	5	20
YT-4188	20	600	490	5	20
YT-4189	22	460	360	5	20
YT-4190	22	600	490	5	20
YT-4191	25	460	360	5	20
YT-4192	25	600	490	5	10

EN Masonry drill bit
 PL Wiertło do betonu
 DE Betonspiralbohrer
 RU Цебрно no бетоны
 CZ Vrták na beton
 HU Fúrószár betonhoz
 RO Burghiu pt. beton
 FR Foret béton
 IT Punta per cemento
 ES Broca para hormigón
 CN 三尖电锤钻

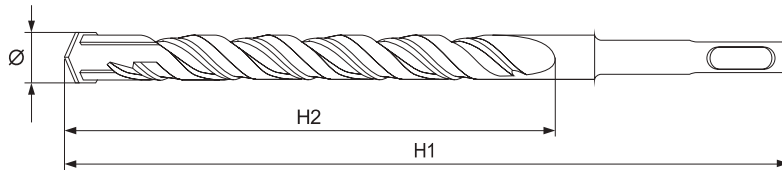

- For windows assembly
- Without necessity of using screw anchors
- Do montażu okien
- Bez użycia kółków rozporowych

YATO	Ø [mm]	H1 [mm]	H2 [mm]	PCS PER BOX	
YT-41641	6.5	200	130	10	10/150
YT-41642	6.5	260	183	10	10/150

EN Masonry drill bit
 PL Wiertło do betonu
 DE Betonspiralbohrer
 RU Цебрно no бетоны
 CZ Vrták na beton
 HU Fúrószár betonhoz
 RO Burghiu pt. beton
 FR Foret béton
 IT Punta per cemento
 ES Broca para hormigón
 CN 十字刀头电锤钻

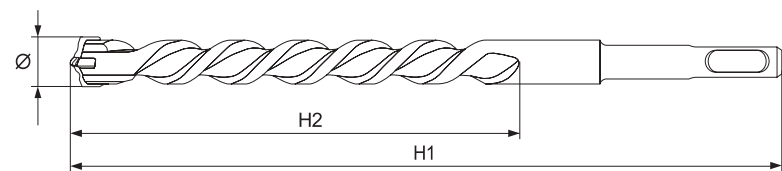

- Resistant for stack in SDS chuck
- DD carbide tip
- Automatic soldering
- Odporne na zakleszczenie w uchwycie SDS
- Widia DD carbide
- Automatische lutowanie

YATO	Ø [mm]	H1 [mm]	H2 [mm]	
YT-41930	5	110	50	40/160
YT-41935	5	160	100	40/160
YT-41931	6	110	50	40/160
YT-41936	6	160	100	40/160
YT-41942	6	210	150	40/160
YT-419503	6	300	250	40/160
YT-41951	6	460	375	30/120
YT-41960	6	600	525	25/100
YT-41932	7	110	50	40/160
YT-41937	7	160	100	40/160
YT-41933	8	110	50	40/160
YT-41938	8	160	100	40/160
YT-41943	8	210	150	40/160
YT-419504	8	300	250	20/160
YT-41952	8	460	375	30/120
YT-41961	8	600	525	20/80
YT-41939	9	160	100	40/160

YATO	Ø [mm]	H1 [mm]	H2 [mm]	
YT-41944	9	210	150	40/160
YT-41934	10	110	50	40/160
YT-41940	10	160	100	40/160
YT-41945	10	210	150	30/120
YT-419505	10	300	250	20/160
YT-41953	10	460	375	30/120
YT-41962	10	600	525	20/80
YT-41941	12	160	100	40/160
YT-41946	12	210	150	30/120
YT-419506	12	300	245	20/160
YT-41954	12	460	375	20/80
YT-41963	12	600	525	15/60
YT-41969	12	1000	930	25
YT-41947	14	210	150	20/80
YT-41955	14	460	375	20/80
YT-41964	14	600	525	15/60
YT-41970	14	1000	930	20

YATO	Ø [mm]	H1 [mm]	H2 [mm]	
YT-41948	16	210	150	20/80
YT-41956	16	460	375	15/60
YT-41965	16	600	525	10/40
YT-41971	16	1000	930	20
YT-41949	18	210	150	20/80
YT-41957	18	460	375	10/40
YT-41966	18	600	525	5/20
YT-41972	18	1000	930	15
YT-41950	22	210	150	20/80
YT-41958	22	460	375	8/32
YT-41967	22	600	525	5/20
YT-41973	22	1000	930	15
YT-41959	25	460	375	8/32
YT-41968	25	600	525	5/20
YT-41974	25	1000	930	15

EN Masonry drill bit
PL Wiertło do betonu
DE Betonspiralbohrer
RU Сверло по бетону
CZ Vrták na beton
HU Fúrészár betonhoz

RO Burghiu pt. beton
FR Foret béton
IT Punta per cemento
ES Broca para hormigón
CN 建工钻

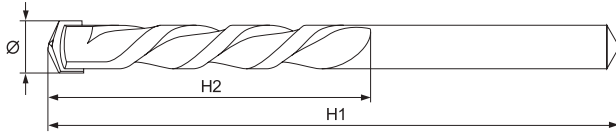
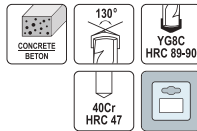

YATO	Ø [mm]	H1 [mm]	H2 [mm]	
YT-4361	4	70	35	100/400
YT-4362	5	90	50	100/400
YT-4363	6	100	60	100/400
YT-4364	6	150	100	100/400
YT-4367	7	100	60	75/300
YT-4369	8	120	80	75/300
YT-4370	8	200	140	50/150

YATO	Ø [mm]	H1 [mm]	H2 [mm]	
YT-4375	10	120	80	75/300
YT-4376	10	200	140	50/150
YT-4379	12	150	100	50/150
YT-4380	12	200	140	50/150
YT-4383	14	180	120	25/100
YT-4385	16	180	120	25/100

EN Masonry drill bit set
PL Komplet wiertel do betonu
DE Betonspiralbohrersatz
RU Свёрла по бетону в наборе
CZ Souprava vrtáků do betonu
HU Fúrészárkészlet betonhoz
RO Set de burghie pt. beton
FR Set des forets béton
IT Set punte per cemento
ES Brocas para hormigón
CN 建工钻组套

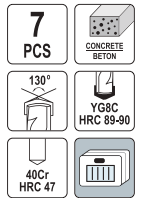

YATO	Ø [mm]	
YT-4390	4, 5, 6, 8, 9, 10, 12	10/80

EN Flat wood drill bit
PL Wiertło łopatkowe do drewna
DE Schaufelbohrer
RU Перовые сверло
CZ Ploché vrták
HU Homlokmarós fűrő
RO Burghiu plate
FR Mèche à bois plate
IT Punta per legno piatta
ES Broca de aletas
CN 木工扁钻

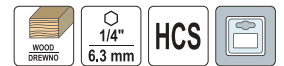
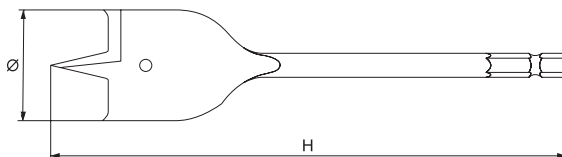

YATO	Ø [mm]	H [mm]	
YT-3236	6	152	50/400
YT-3237	8	152	50/400
YT-3238	10	152	50/300
YT-3239	12	152	50/300
YT-3240	13	152	50/300
YT-3241	14	152	50/300
YT-3242	16	152	50/300

YATO	Ø [mm]	H [mm]	
YT-3243	18	152	50/300
YT-3244	20	152	50/300
YT-3245	22	152	50/300
YT-3246	24	152	50/300
YT-3247	25	152	50/300
YT-3248	26	152	50/300
YT-3249	28	152	50/300

YATO	Ø [mm]	H [mm]	
YT-3250	30	152	50/200
YT-3251	32	152	50/200
YT-3252	34	152	50/200
YT-3253	35	152	50/200
YT-3254	38	152	50/200
YT-3255	40	152	50/200

EN Extension for flat wood drill bits
PL Przedłużka do wiertel łopatkowych, bitów i wiertel
DE Verlängerung für Schaufelbohrer
RU Удлинитель для перовых сверл
CZ Nástavec pro ploché vrtáky
HU Hosszabbító homlokmarós fűrőkhöz
RO Prelungitor pt. burghie plate
FR Rallonge pour mèches à bois
IT Prolunga per punta fresatrice
ES Extensión para brocas de aletas
CN 木工扁钻延长杆

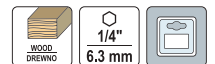
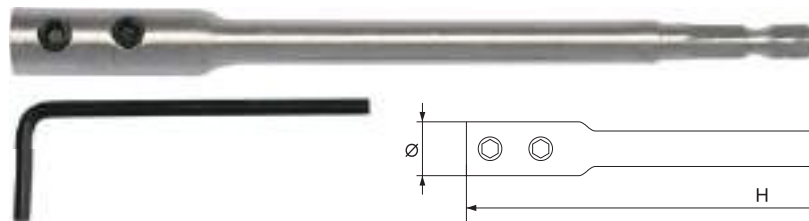

YATO	Ø [mm]	H [mm]	
YT-3256	12.2	150	60/120
YT-3257	13.5	300	30/60

EN Flat wood drill bit set
PL Zestaw wiertel łopatkowych
DE Schaufelbohrersatz
RU Набор перовых сверл
CZ Sada plochých vrtáků
HU Homlokmarós fűrő készlet
RO Set burghie plate
FR Set de mèche à bois
IT Set di punte per legno piatta
ES Juego de brocas de aletas
CN 木工扁钻组套

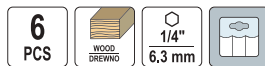

YATO	Ø [mm]	H [mm]	
YT-3258	10, 12, 16, 18, 20, 25	152	25/50

EN Flat wood drill bit set
PL Zestaw wiertel łopatkowych
DE Schaufelbohrersatz
RU Набор перовых сверл
CZ Sada plochých vrtáků
HU Homlokmarós fűrő készlet

RO Set burghie plate
FR Set de mèche à bois
IT Set di punte per legno piatta
ES Juego de brocas de aletas
CN 木工扁钻组套

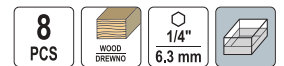

YATO	Ø [mm]	H [mm]	
YT-3259	12, 16, 18, 20, 22, 25, 28, 32	152	5/20

EN Spur wood drill bit
 PL Wiertło do drewna spiralne
 DE Spiralbohrer für Holz
 RU Спиральное сверло по дереву
 CZ Vrták do dřeva spirálový
 HU Csigafúró fához
 RO Burghiu spirală pt. lemn
 FR Mèches hélicoïdales à bois
 IT Punta per legno spirale
 ES Barrena para madera espiral
 CN 木工钻

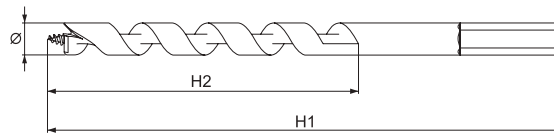

YATO	Ø [mm]	H1 [mm]	H2 [mm]	Box
YT-4350	3	60	35	30/300
YT-4351	4	75	44	30/300
YT-4352	5	85	52	30/300
YT-4353	6	90	57	30/300

YATO	Ø [mm]	H1 [mm]	H2 [mm]	Box
YT-4354	7	100	67	30/300
YT-4355	8	110	75	30/300
YT-4356	10	120	77	30/300
YT-4357	12	150	97	15/120

YATO	Ø [mm]	H1 [mm]	H2 [mm]	Box
YT-4358	13	150	102	15/120
YT-4359	16	160	120	15/120

EN Spur wood drill bit
 PL Wiertło do drewna spiralne
 DE Spiralbohrer für Holz
 RU Спиральное сверло по дереву
 CZ Vrták do dřeva spirálový
 HU Csigafúró fához
 RO Burghiu spirală pt. lemn
 FR Mèches hélicoïdales à bois
 IT Punta per legno spirale
 ES Barrena para madera espiral
 CN 木工钻

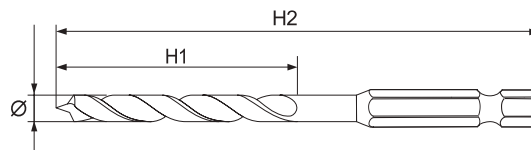
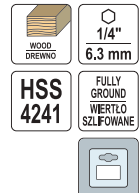

YATO	Ø [mm]	H1 [mm]	H2 [mm]	Box
YT-33860	3	61	33	125/500
YT-33861	4	75	43	125/500
YT-33862	5	86	52	75/300
YT-33863	6	93	57	75/300

YATO	Ø [mm]	H1 [mm]	H2 [mm]	Box
YT-33864	7	109	69	75/300
YT-33865	8	117	75	75/300
YT-33866	10	133	87	75/300
YT-33867	12	151	101	75/300

YATO	Ø [mm]	H1 [mm]	H2 [mm]	Box
YT-33868	13	151	101	50/200
YT-33869	14	160	108	50/200
YT-33870	16	178	120	50/200

10

EN Spur wood drill set
 PL Zestaw wiertel spiralnych do drewna
 DE Holzspiralbohrer-Set
 RU Набор спиральных сверел по дереву
 CZ Sada spirálových vrtáků do dřeva
 HU Spirál fűrészsár készlet
 RO Set burghie pt. lemn
 FR Jeu de forets à spirale pour bois
 IT Set di punte spirali per legno
 ES Juego de brocas espirales para la madera
 CN 高速钢整体木工钻组套

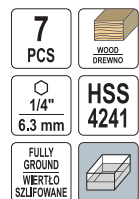

YATO	Ø [mm]	Box
YT-33873	3, 4, 5, 6, 7, 8, 10	20/80

EN Auger drill bit hex
 PL Wiertło do drewna 4-ostrowe Hex
 DE 4-flöte Schlangenbohrer
 RU Сверло по дереву Hex с 4 режущими кромками
 CZ Vrták do dřeva
 HU Auger fűrészsár bit befogással
 RO Burghiu sfredel
 FR 4 diamètre ébénisterie bois foret
 IT Punta esagonale per legno
 ES Broca espiral de madera Hex
 CN 四槽木工钻

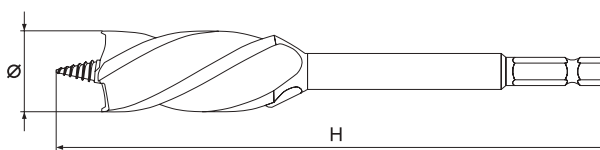

YATO	Ø [mm]	H [mm]	Box
YT-44680	10	165	100/200
YT-44681	12	165	100/200
YT-44682	14	165	100/200
YT-44683	16	165	100/200

YATO	Ø [mm]	H [mm]	Box
YT-44684	18	165	75/150
YT-44685	20	165	75/150
YT-44686	22	165	50/100
YT-44687	25	165	50/100

YATO	Ø [mm]	H [mm]	Box
YT-44688	28	165	50/100
YT-44689	30	165	50/100
YT-44690	32	165	50/100

- EN Auger drill bit set
- PL Zestaw wiertel do drewna 4-ostrzowych Hex
- DE Schlangenbohrer 4-flöte Set
- RU Набор сверл по дереву с 4 режущими кромками
- CZ Sada vrtáků do dřeva
- HU Auger fafűrészár bit befogással készlet
- RO Set burghiu sfredel
- FR Coffret 4 diamètre ébénisterie bois foret
- IT Set di punte esagonali per legno
- ES Juego de brocas espiral de madera Hex
- CN 木工钻



7
PCS

WOOD DREWING

1/4"
6.3 mm

HRC
40-45

1/4" (6.3 mm): 16, 18, 20, 22, 25 mm (L=165 mm);
1/4" (6.3 mm); (300 mm);

YATO

YT-44693

10/20

- EN Auger wood drill bit
- PL Świder do drewna
- DE Holzbohrer
- RU Бур по дереву
- CZ Vrták do dřeva hadovitý
- HU Fafűrő
- RO Burghiu elicoidal pt. lemn
- FR Foret spirale à bois
- IT Punta a torciglione per legno
- ES Barrena para madera
- CN 螺旋木工钻



WOOD DREWING

13 mm

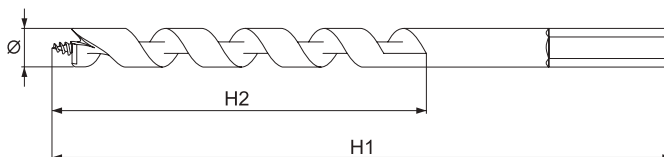

YATO	Ø [mm]	H1 [mm]	H2 [mm]	
YT-3261	6	230	150	150/300
YT-3262	8	230	150	140/280
YT-3263	8	460	360	60/120
YT-3264	10	230	150	100/200
YT-3265	10	460	360	50/100
YT-3266	12	190	150	75/150
YT-3267	12	460	360	30/60
YT-3268	13	230	150	50/100
YT-3269	13	400	310	30/60
YT-3270	14	191	150	50/100
YT-3271	14	460	360	30/60
YT-3272	16	230	150	50/100
YT-3273	16	460	360	20/40

YATO	Ø [mm]	H1 [mm]	H2 [mm]	
YT-3274	18	230	150	40/80
YT-3275	18	460	360	20/40
YT-3276	20	230	150	30/60
YT-3277	20	460	360	20/40
YT-3278	22	230	150	20/60
YT-3279	22	460	360	15/30
YT-3280	24	230	150	30/60
YT-3281	24	460	360	15/30
YT-3282	25	230	150	20/40
YT-3283	25	460	360	15/30
YT-3284	26	230	150	20/40
YT-3285	26	460	360	10/20
YT-3286	28	230	150	10/20

YATO	Ø [mm]	H1 [mm]	H2 [mm]	
YT-3287	28	460	360	10/20
YT-3288	30	230	150	10/20
YT-3289	30	460	360	5/10
YT-3290	32	230	150	10/20
YT-3291	32	460	360	5/10
YT-3292	35	230	150	10/20
YT-3293	35	460	360	5/10
YT-3294	36	230	150	10/20
YT-3295	36	460	360	5/10
YT-3296	38	230	150	10/20
YT-3297	40	230	360	10/20

- EN Auger wood drill bit set
- PL Zestaw świderów do drewna
- DE Holzbohrersatz
- RU Набор буров по дереву
- CZ Sada hadovitých vrtáků do dřeva
- HU Fafűrő készlet
- RO Set de burghie elicoidale pt. lemn
- FR Set de forets spirales à bois
- IT Set di punte a torciglione
- ES Juego de barrenas para madera
- CN 螺旋木工钻组套

6
PCS

WOOD DREWING



13 mm



13 mm



SDS PLUS

YATO	Ø [mm]	H [mm]	
YT-3299	10, 12, 14, 16, 18, 20	460	8

YATO	Ø [mm]	H [mm]	
YT-3298	10, 12, 14, 16, 18, 20	230	15

YATO	Ø [mm]	H [mm]	
YT-3300	10, 12, 14, 16, 18, 20	230	20

- EN Conformat screw drill bit
- PL Wiertło do konfirmatów
- DE Konfirmatbohrer
- RU Сверло под конфирмат
- CZ Vrták na konfirmáty
- HU Konfirmátor csavar előfúró
- RO Burghiu tip bit pt. mobilier
- FR Foret à vis confirmat
- IT Avvitatore per viti di assemblaggio mobili
- ES Broca para tornillos confirmat
- CN 倒角器木工钻

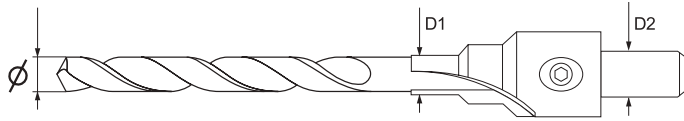

YATO	Ø [mm]	D1 [mm]	D2 [mm]	
YT-33021	4	7	8	25/250
YT-33022	5	7	8	25/250
YT-33023	7	10	8	25/250

- EN Drill for ceramic tiles
- PL Wiertło do ceramiki i gresu
- DE Keramik und Fliesen Bohr
- RU Бурильные плитки и керамики
- CZ Vrtací tašek a keramických výrobků
- HU Fúró cserép és kerámia
- RO Burghiu pt. ceramica si sticla
- FR Tuiles de forage et de la céramique
- IT Piastrelle e ceramiche trapano
- ES Azulejos y cerámicas de perforación
- CN 玻璃钻



YATO	Ø [mm]	
YT-3725	4	100/400
YT-3726	6	100/400

- EN Diamond tile drill bit
- PL Koronka diamentowa
- DE Diamantbohrkrone für Winkelschleifer
- RU Алмазная коронка
- CZ Diamantová korunka
- HU Gyémánt koronafúró
- RO Burghiu diamant
- FR Trépan diamant
- IT Punta a corona diamantata
- ES Broca diamante
- CN 金刚石电镀薄壁钻

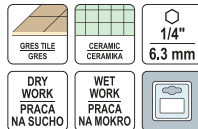

YATO	Ø [mm]	σ [min ⁻¹]	
YT-60401	6	1500	50/200
YT-60402	8	1500	50/200
YT-60403	10	1500	50/200

- EN Diamond tile drill bit
- PL Koronka diamentowa
- DE Diamantbohrkrone für Winkelschleifer
- RU Алмазная коронка
- CZ Diamantová korunka
- HU Gyémánt koronafúró
- RO Burghiu diamant
- FR Trépan diamant
- IT Punta a corona diamantata
- ES Broca diamante
- CN 金刚石电镀薄壁钻



YATO	Ø [mm]	
YT-3727	8	100/400
YT-3728	10	50/200

- EN Diamond tile drill bit
- PL Koronka diamentowa
- DE Diamantbohrkrone für Winkelschleifer
- RU Алмазная коронка
- CZ Diamantová korunka
- HU Gyémánt koronafúró
- RO Burghiu diamant
- FR Trépan diamant
- IT Punta a corona diamantata
- ES Broca diamante
- CN 金刚石电镀薄壁钻



YATO	Ø [mm]	σ [min ⁻¹]	
YT-60409	6, 8, 10	1500	20/80

YATO	Ø [mm]	σ [min ⁻¹]	
YT-60421	5	600	50/400
YT-60422	6	600	50/400
YT-60423	8	600	50/400
YT-60424	10	600	50/500
YT-60425	12	600	50/200
YT-60426	14	600	50/200
YT-60427	16	600	50/200
YT-60428	20	500	25/100
YT-60429	25	500	25/100
YT-60430	30	500	25/100
YT-60431	40	500	15/60
YT-60432	50	400	15/60
YT-60433	68	400	8/40
YT-60434	80	400	5/25
YT-60435	105	400	4/20
YT-60436	125	400	4/20

EN Dry diamond tile drill bit
PL Koronka diamentowa
DE Diamantbohrkrone für Winkelschleifer
RU Алмазная коронка
CZ Diamantová korunka
HU Gyémánt koronafúró
RO Burghiu diamant
FR Trépan diamant
IT Punta a corona diamentata
ES Broca diamante
CN 钎焊薄壁钻



YATO	Ø [mm]	o [min ⁻¹]	
YT-60441	6	12200	100/200
YT-60442	8	12200	100/200
YT-60443	10	12200	100/200
YT-60444	20	12200	100/200
YT-60445	30	12200	50/100
YT-60446	51	12200	40/80
YT-60447	68	12200	50

EN Adjustable hand reamer
PL Rozwiertak nastawny
DE Verstellbare Reibahle
RU Регулируемая развертка
CZ Nastavitelný výstružník
HU Állítható dörzsár

RO Alezor reglabil
FR Alesoir à main réglable
IT Alesatore regolabile
ES Escariador ajustable
CN 可调式手动铰刀



YATO	Working diameter / Średnica robocza [mm²]	L [mm]	Arbor diameter / Średnica trzpienia [mm²]	
YT-28950	7.75-8.5	107	4.5	50/200
YT-28951	8.5-9.25	112	4.5	50/200
YT-28952	9.25-10	116	5.0	50/200
YT-28953	10-10.75	125	5.5	50/200
YT-28954	10.75-11.75	130	6.5	50/200
YT-28955	11.75-12.75	135	7.5	50/150
YT-28956	12.75-13.75	140	7.5	50/150
YT-28957	13.75-15.25	158	8.0	20/60
YT-28958	15.25-17	165	9.0	20/60

YATO	Working diameter / Średnica robocza [mm²]	L [mm]	Arbor diameter / Średnica trzpienia [mm²]	
YT-28959	17-19	175	10.0	20/60
YT-28960	19-21	180	11.5	20/60
YT-28961	21-23	193	13.5	20/60
YT-28962	23-26	210	15.4	4/20
YT-28963	26-29.5	245	17.0	4/20
YT-28964	29.5-33.5	270	19.0	4/20
YT-28965	33.5-38	310	21.0	2/10
YT-28966	38-44	345	24.0	2/10
YT-28967	44-54	400	30.0	5

EN Straight hole doweling jig kit
PL Uchwyt do wiercenia prostopadłego
DE Bohrschablone zum senkrechten Vorbohren
RU Ручка для перпендикулярного сверления
CZ Rukojeť pro kolmé vrtání
HU Fúrósablon merőleges fúráshoz
RO Kit pt. gaurit
FR Guide de perçage mobile
IT Mandrino per foratura verticale
ES Soporte para perforación perpendicular
CN 打孔定位器



YATO	Ø [mm]	
YT-39700	4, 5, 6, 8, 10, 12	40

EN Depth collars for drills
PL Ogranicznik głębokości wiercenia
DE Bohrtiefenbegrenzer
RU Ограничитель глубины для сверл
CZ Omezovač hloubky vrtáku
HU Mélységűtköző
RO Limitator adancime pt. burghiu
FR Butées de profondeur
IT Arresto di profondità
ES Tope de profundidad para brocas
CN 木工定位器



3
PCS



YATO	Ø [mm]	
YT-44100	6, 8, 10	250/500

EN Dowelling centre points
PL Znaczniki do wyznaczania otworów
DE Holzdübel-Markierspitzen
RU Набор кернов для мебельных шкантов
CZ Značící hroty pro kolíkování
HU Típlí jelölő
RO Cep pt. centrare
FR Centreurs
IT Set centroratori per spine
ES Centradores
CN 木工顶尖

4
PCS



YATO	Ø [mm]	
YT-44104	6	25/100
YT-44105	8	25/100
YT-44106	10	25/100

EN Dowel set
 PL Zestaw do połączeń kółkowych
 DE Holzdübeln-Werkzeugsatz
 RU Набор для соединения на шкантах
 CZ Kollkovací sada
 HU Facsapozó készlet
 RO Set pt. imbinari cu dibluri lem
 FR Kit d'assemblage bois en mains libres
 IT Set di spinatura in legno
 ES Juego para ensamblaje de madera
 CN 木工顶尖

17
PCS

6.0
mm



6x40 mm (10 PCS);
 6 mm (4 PCS);
 6 mm;
 2.5 mm;
 6x100 mm

YATO	Ø [mm]	
YT-44112	6	4/100

EN Dowel set
 PL Zestaw do połączeń kółkowych
 DE Holzdübeln-Werkzeugsatz
 RU Набор для соединения на шкантах
 CZ Kollkovací sada
 HU Facsapozó készlet
 RO Set pt. imbinari cu dibluri lem
 FR Kit d'assemblage bois en mains libres
 IT Set di spinatura in legno
 ES Juego para ensamblaje de madera
 CN 木工顶尖

17
PCS

8.0
mm



8x40 mm (10 PCS);
 8 mm (4 PCS);
 8 mm;
 2.5 mm;
 8x100 mm

YATO	Ø [mm]	
YT-44111	8	4/100

EN Dowel set
 PL Zestaw do połączeń kółkowych
 DE Holzdübeln-Werkzeugsatz
 RU Набор для соединения на шкантах
 CZ Kollkovací sada
 HU Facsapozó készlet
 RO Set pt. imbinari cu dibluri lem
 FR Kit d'assemblage bois en mains libres
 IT Set di spinatura in legno
 ES Juego para ensamblaje de madera
 CN 木工顶尖

17
PCS

10
mm



10x40 mm (10 PCS);
 10 mm (4 PCS);
 10 mm;
 2.5 mm;
 10x100 mm

YATO	Ø [mm]	
YT-44113	10	4/100

10

EN Dowel set
 PL Zestaw do połączeń kółkowych
 DE Holzdübeln-Werkzeugsatz
 RU Набор для соединения на шкантах
 CZ Kollkovací sada
 HU Facsapozó készlet
 RO Set pt. imbinari cu dibluri lem
 FR Kit d'assemblage bois en mains libres
 IT Set di spinatura in legno
 ES Juego para ensamblaje de madera
 CN 木工定位木销组套

154
PCS

6, 8, 10
mm

METAL
TEMPLATE
SZABLON
METALOWY

GUIDE
PROWADNICA

ANGLE
STOP
OGRAŃCZNIK
KĄTOWY



Doweling jig / Prowadnica do nawiercania otworów:
 Ø 3, 3.3, 4, 4.2, 5, 6, 6.8, 8, 10, 12 mm

6x30 mm (50 PCS), 8x40 mm (50 PCS), 10x40 mm (50 PCS);
 6, 8, 10 mm

YATO	Ø [mm]	
YT-44122	6, 8, 10	2/10

EN Drill guider with handle
 PL Przyrząd do połączeń kółkowych
 DE Dübel Bohrschablone
 RU Кондуктор для сверления отверстий
 CZ Kollkovací přípravek
 HU Tipíróz sablon
 RO Sablon pt. dibluri lem
 FR Guide de perçage pour assemblage par tourillons
 IT Dima per spinatura legno
 ES Guia de perforación
 CN 摆臂斜孔定位器

6, 8, 10
mm

AI



YATO	Ø [mm]	
YT-44120	6, 8, 10	10

EN Drill gauge and depth stop set
 PL Sprawdzian do średnic i ograniczniki głębokości
 DE Durchmesserlehre und Tiefenanschlag
 RU Измеритель диаметра и ограничитель глубины
 CZ Měřidlo průměru a hloubkové dorazy
 HU Átmérőellenőrző és mélységátaroló
 RO Set sablon gaurire cu opritor
 FR Jauges de diamètre et butées de profondeur
 IT Calibro per diametri e limitatori di profondità
 ES Calibre de diámetros y limitador de brocas
 CN 钻头量规

10
PCS

1/16"-1/2"
1.0-13mm

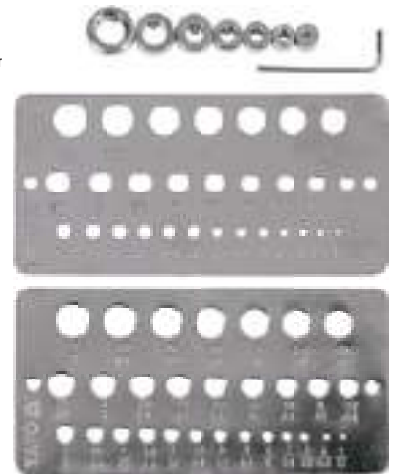

3, 4, 5, 6, 8, 10, 12 mm;
 1.5 mm

YATO	Ø	
YT-44095	1/16"-1/2" / 1.0-13 mm	20/60

EN Tool drill guide
 PL Szablone do wyznaczania otworów
 DE Schablone zur Markierung von Löchern
 RU Шаблон для разметки отверстий
 CZ Šablona pro značení otvorů
 HU Nyílássablon

RO Instrument ghidare pt. gaurire
 FR Gabarit pour le marquage des trous
 IT Sagoma per fori
 ES Plantilla para determinar perforaciones
 CN 打孔定位工具

250
mm

AI





YATO		
YT-44130		20

EN Point chisel SDS Plus RU Зубило SDS Plus RO Punctator SDS Plus ES Cincel puntiagudo SDS Plus
PL Przecinak SDS Plus CZ Sekáč špičák SDS Plus FR Perçoir SDS Plus CN 尖凿
DE Spitzmeißel SDS Plus HU Hegyes véső SDS Plus IT Scalpello a punta SDS Plus

4x14
x250
mm **SDS
PLUS** **CrV** 





YATO 	L [mm]	
YT-4720	250	6/48

EN Wood chisel SDS Plus RU Долото столярски SDS Plus RO Daltă de tâmplărie SDS Plus ES Cincel para madera SDS Plus
PL Dłuto do drewna SDS Plus CZ Řezbářské dláto SDS Plus FR Ciseau SDS Plus CN 木工凿
DE Stechbeitel SDS Plus HU Asztalos véső SDS Plus IT Scalpello SDS Plus

 **12x180
mm** **SDS
PLUS** **CrMo** 





YATO 	L [mm]	
YT-4720	180	10/80

EN Flat chisel SDS Plus RU Долото узкое SDS Plus RO Punctator pt. adancit SDS Plus ES Cincel plano estrecho SDS Plus
PL Dłuto wąskie SDS Plus CZ Sekáč plochý SDS Plus FR Ciseau SDS Plus CN 平凿
DE Flachmeißel SDS Plus HU Lapos véső SDS Plus IT Scalpello piatto SDS Plus, punta stretta

20x14
x250
mm **SDS
PLUS** **CrV** 





YATO 	L [mm]	
YT-4721	250	6/48

EN Hollow chisel SDS Plus RU Бороzdник SDS Plus RO Punctator pt. adancit SDS Plus ES Cincel acanalado SDS Plus
PL Bruzdownik SDS Plus CZ Sekáč drážkovací SDS Plus FR Burin à entailler SDS Plus CN 空心凿
DE Nutenmeißel SDS Plus HU Horonyvéső SDS Plus IT Scalpello per scanalature SDS Plus

22x18
x250
mm **SDS
PLUS** **CrV** 





YATO 	L [mm]	
YT-4722	250	6/48

EN Flat chisel SDS Plus RO Punctator tip dalta SDS Plus
PL Dłuto płaskie SDS Plus FR Ciseau SDS Plus
DE Spatmeißel SDS Plus IT Scalpello piatto SDS Plus
RU Долото плоское SDS Plus ES Cincel plano SDS Plus
CZ Sekáč plochý SDS Plus CN 扁凿
HU Széles lapos véső SDS Plus

40x14
x250
mm **SDS
PLUS** **CrV** 





YATO 	L [mm]	
YT-4723	250	6/48

EN Flat chisel SDS Plus RO Punctator tip dalta SDS Plus
PL Dłuto płaskie SDS Plus FR Ciseau SDS Plus
DE Spatmeißel SDS Plus IT Scalpello piatto SDS Plus
RU Долото плоское SDS Plus ES Cincel plano SDS Plus
CZ Sekáč plochý SDS Plus CN 扁凿
HU Széles lapos véső SDS Plus

80x250
mm **SDS
PLUS** **CrMo** 





YATO 	L [mm]	
YT-47212	250	10/20

EN Groove chisel RO Dalta canal
PL Bruzdownik FR Burin à entailler
DE Nutenmeißel IT Scalpello per scanalature
RU Зубило канавочное ES Cincel acanalado
CZ Sekáč drážkovací CN 五坑蝴蝶凿
HU Horonyvéső

 **26x300
mm** **SDS
MAX** 





YATO 	L [mm]	
YT-4731	300	10/30

EN Groove chisel
 PL Bruzdownik
 DE Nutenmeißel
 RU Зубило канавочное
 CZ Sekáč drážkovací
 HU Horonyvő

RO Dalta canal
 FR Burin a entailler
 IT Scalpello per scanalature
 ES Cíncel acanalado
 CN 五坑蝴蝶凿



 35x380 mm **SDS MAX** 



YATO 	L [mm]	
YT-47330	380	10/20

EN Spade chisel
 PL Dłuto szerokie
 DE Spatmeißel
 RU Лопатка
 CZ Sekáč plochý
 HU Széles véső

RO Dalta
 FR Burin plat large
 IT Scalpello largo
 ES Cíncel pala
 CN 五坑扁凿



 50x400 mm **SDS MAX** 

YATO 	L [mm]	
YT-47336	400	10/20

EN Spade chisel
 PL Dłuto szerokie
 DE Spatmeißel
 RU Лопатка
 CZ Sekáč plochý
 HU Széles véső

RO Dalta
 FR Burin plat large
 IT Scalpello largo
 ES Cíncel pala
 CN 五坑扁凿



 75x300 mm **SDS MAX** 

YATO 	L [mm]	
YT-47335	300	10/20

EN Spade chisel
 PL Dłuto płaskie
 DE Spatmeißel
 RU Лопатка
 CZ Sekáč plochý
 HU Széles véső

RO Dalta
 FR Burin plat large
 IT Scalpello piatto
 ES Cíncel pala
 CN 五坑扁凿



 25x280 mm **SDS MAX** 

YATO 	L [mm]	
YT-47341	280	10/40

EN Spade chisel
 PL Dłuto płaskie
 DE Spatmeißel
 RU Лопатка
 CZ Sekáč plochý
 HU Széles véső

RO Dalta
 FR Burin plat large
 IT Scalpello piatto
 ES Cíncel pala
 CN 五坑扁凿



 25x400 mm **SDS MAX** 

YATO 	L [mm]	
YT-47340	400	10/20

EN Point chisel
 PL Dłuto szpiczak
 DE Spitzmeißel
 RU Зубило пиковое
 CZ Špičák
 HU Hegyes véső

RO Dorn
 FR Burin pointu
 IT Scalpello a punta
 ES Cíncel punta
 CN 五坑尖凿



 280 mm **SDS MAX** 

YATO 	L [mm]	
YT-47345	280	10/40

EN Point chisel
 PL Dłuto szpiczak
 DE Spitzmeißel
 RU Зубило пиковое
 CZ Špičák
 HU Hegyes véső

RO Dorn
 FR Burin pointu
 IT Scalpello a punta
 ES Cíncel punta
 CN 五坑尖凿



 400 mm **SDS MAX** 

YATO 	L [mm]	
YT-47344	400	10/20

EN Bushing tool
 PL Groszkownik
 DE Stockerplatte
 RU Отбойные пластины
 CZ Zdršňovací deska
 HU Szemcsészlap

RO Placă de tasare
 FR Boucharde
 IT Bocciarda per martello
 ES Placa de abujardar
 CN 五坑花锤



 60x240 mm **SDS MAX** 

YATO 	L [mm]	
YT-47348	240	5/10

EN Spade chisel
PL Dłuto szerokie
DE Spatmeißel
RU Широкое долото
CZ Sekáč plochý
HU Széles véső

RO Dalta
FR Burin plat large
IT Scalpello largo
ES Cíncel pala
CN 六角扁凿



75x450
mm



YATO 

L [mm]



YT-47370

450

5/10

EN Spade chisel
PL Dłuto szerokie
DE Spatmeißel
RU Широкое долото
CZ Sekáč plochý
HU Széles véső

RO Dalta
FR Burin plat large
IT Scalpello largo
ES Cíncel pala
CN 六角宽凿



125x450
mm



YATO 

L [mm]



YT-47372

450

5

EN Point chisel
PL Dłuto szpiczak
DE Spitzmeißel
RU Зубило ликовое
CZ Špičák
HU Hegyes véső

RO Dorn
FR Burin pointu
IT Scalpello a punta
ES Cíncel punta
CN 五坑尖凿



410
mm



YATO 

L [mm]



YT-47375

410

5/10

EN Spade chisel
PL Dłuto płaskie
DE Spatmeißel
RU Лопатка
CZ Sekáč plochý
HU Széles véső

RO Dalta
FR Burin plat large
IT Scalpello piatto
ES Cíncel pala
CN 五坑扁凿



35x410
mm



YATO 

L [mm]



YT-47377

410

5/10

EN Point chisel
PL Dłuto samoostrzące
DE Spitzmeißel
RU Зубило ликовое
CZ Špičák
HU Hegyes véső

RO Dorn
FR Burin pointu
IT Scalpello a punta autoaffilante
ES Cíncel punta
CN 四刃凿子



410
mm



YATO 

L [mm]



YT-47380

410

5/10

EN Adapter
PL Adapter
DE Adapter
RU Адаптер

CZ Adaptér
HU Adapter
RO Adaptor
FR Adaptateur

IT Adattatore
ES Adaptador
CN 五坑转换器



220
mm

SDS
MAX

SDS
PLUS



YATO 

L [mm]



YT-41926

220

10/30

EN Ground rod chisel
PL Pobijak do uziomów i gwoździ
DE Erdstab-Treiber-Bit
RU Добойник для гвоздей
CZ Zatloukač uzemňovacích tyčí a hřebíků
HU Rudazatbeütő

RO Ciocan bățut buloane cale ferată
FR Enfonceur de piquet de terre
IT Piantapicchetti per piantare chiodi e picchetti
ES Adaptador de varilla de tierra
CN 电镐圆孔凿

20
mm

250
mm

SDS
MAX

CrMo



YATO 

L [mm]



YT-47195

250

4/24

EN Plate compactor with hex shank
PL Ubijak do gruntu z uchwytem Hex
DE Stampfüsse Hex
RU Трамбовочная пластина
CZ Pěchovací deska Hex
HU Szerszámtartós tömörítőlap Hex

RO Buciardă Hex
FR Plateau de damage Hex
IT Costipatore Hex per la compattazione di terra
ES Placa de apisonar Hex
CN 六角夯锤



150x150
mm



YATO 

L [mm]



YT-47385

150

2

EN Ground rod chisel
PL Pobijak do uziomów i gwoździ
DE Erdstab-Treiber-Bit
RU Добойник для гвоздей
CZ Zatloukač uzemňovacích tyčí a hřebíků
HU Rudazatbeütő

RO Ciocan bățut buloane cale ferată
FR Enfonceur de piquet de terre
IT Piantapicchetti per piantare chiodi e picchetti
ES Adaptador de varilla de tierra
CN 电镐圆孔凿

25
mm

400
mm



YATO 

L [mm]



YT-47197

400

4

EN Hollow drill set
PL Wiertło koronowe do betonu
DE Bohrkone
RU Свёрла по бетону корончатые

CZ Korunový vrták na zeď
HU Koronafúró falhoz
RO Burghiu cu coroaană pt. beton
FR Trépiéd à mur

IT Punta a corona per calcestruzzo
ES Broca widia para muro
CN 扩孔钻



50 mm

M16

TCT
YG11C

Cr50



SDS
PLUS

12 mm

YATO	Ø [mm]	Pilot drill diameter / Średnica wiertła pilota [mm]	
YT-4400	65	6	24
YT-4401	65	8	20

YATO	Ø [mm]	Pilot drill diameter / Średnica wiertła pilota [mm]	
YT-4402	65	6	24
YT-4403	08	8	20

EN Masonry drill bit
PL Wiertło do betonu
DE Betonspiralbohrer
RU Свёрло по бетону
CZ Vrták na beton
HU Fúrószár betonhoz
RO Burghiu pt. beton
FR Foret béton
IT Punta per cemento
ES Broca para hormigón
CN 四坑开孔器



280 mm

SDS
PLUS



YATO	Ø [mm]	L [mm]	
YT-44033	68	280	2/10
YT-44034	82	280	2/6

EN Masonry drill bit
PL Wiertło do betonu
DE Betonspiralbohrer
RU Свёрло по бетону
CZ Vrták na beton
HU Fúrószár betonhoz

RO Burghiu pt. beton
FR Foret béton
IT Punta per cemento
ES Broca para hormigón
CN 四坑开孔器



55 mm

600 mm

SDS
MAX



YATO	Ø [mm]	L [mm]	
YT-44045	55	600	2/8

EN Hole saw
PL Otwornica
DE Lochsäge
RU Универсальная коронка
CZ Vrtací korunka
HU Koronafúró

RO Căurătorii
FR Scie à trou
IT Sega a tazza
ES Sierra de corona universal
CN TCT开孔器



60 mm

YG6X



YATO	Ø [mm]	Thread size / Rozmiar gwintu	
YT-43970	16	1/2" (12.5 mm) 20UNF	6/90
YT-43971	19	1/2" (12.5 mm) 20UNF	6/90
YT-43972	22	1/2" (12.5 mm) 20UNF	6/90
YT-43973	25	1/2" (12.5 mm) 20UNF	6/90
YT-43974	32	5/8" (16.0 mm) 18UNF	6/72
YT-43975	38	5/8" (16.0 mm) 18UNF	6/72

YATO	Ø [mm]	Thread size / Rozmiar gwintu	
YT-43976	51	5/8" (16.0 mm) 18UNF	6/72
YT-43977	60	5/8" (16.0 mm) 18UNF	6/72
YT-43978	64	5/8" (16.0 mm) 18UNF	3/36
YT-43979	68	5/8" (16.0 mm) 18UNF	3/36
YT-43980	76	5/8" (16.0 mm) 18UNF	3/36
YT-43981	83	5/8" (16.0 mm) 18UNF	3/36

YATO	Ø [mm]	Thread size / Rozmiar gwintu	
YT-43982	92	5/8" (16.0 mm) 18UNF	2/36
YT-43983	102	5/8" (16.0 mm) 18UNF	2/36
YT-43984	105	5/8" (16.0 mm) 18UNF	2/36
YT-43985	127	5/8" (16.0 mm) 18UNF	2/20
YT-43986	152	5/8" (16.0 mm) 18UNF	2/20

EN Bi-metal hole saw
PL Otwornica bimetalowa
DE Bimetall-Lochsäge
RU Коронка биметаллическая
CZ Vrtací korunka bimetalová
HU Bi-metál koronafúró
RO Freză bimetalică
FR Scie-trépan bimétal
IT Sega a tazza bimetallica
ES Sierra de corona bimetalica
CN 双金属孔锯



BI-METAL

4-6
TPI

40 mm

HSS
M3



• Application: industry
• To drill holes in stainless steels, cast steels, aluminium, wood, plastics
• Cutting depth: 40 mm

• Przeznaczenie: przemysł
• Do wycinania otworów w stalach nierdzewnych, żeliwie, aluminium, drewnie, tworzywach sztucznych
• Głębokość cięcia: 40 mm

YATO	Ø [mm]	Thread size / Rozmiar gwintu	
YT-3303	19	1/2" (12.5 mm) 20UNF	25/100
YT-3304	20	1/2" (12.5 mm) 20UNF	25/100
YT-3306	22	1/2" (12.5 mm) 20UNF	25/100
YT-3308	25	1/2" (12.5 mm) 20UNF	25/100
YT-3311	29	1/2" (12.5 mm) 20UNF	25/100
YT-3313	32	5/8" (16.0 mm) 18UNF	25/100
YT-3315	35	5/8" (16.0 mm) 18UNF	25/100
YT-3317	38	5/8" (16.0 mm) 18UNF	25/100
YT-3318	40	5/8" (16.0 mm) 18UNF	25/100
YT-3321	44	5/8" (16.0 mm) 18UNF	25/100

YATO	Ø [mm]	Thread size / Rozmiar gwintu	
YT-3322	46	5/8" (16.0 mm) 18UNF	25/100
YT-3323	48	5/8" (16.0 mm) 18UNF	25/100
YT-3324	51	5/8" (16.0 mm) 18UNF	25/100
YT-3327	57	5/8" (16.0 mm) 18UNF	25/50
YT-3329	60	5/8" (16.0 mm) 18UNF	25/50
YT-3330	64	5/8" (16.0 mm) 18UNF	25/50
YT-3332	67	5/8" (16.0 mm) 18UNF	25/50
YT-3333	68	5/8" (16.0 mm) 18UNF	25/50
YT-3334	70	5/8" (16.0 mm) 18UNF	25/50
YT-3336	76	5/8" (16.0 mm) 18UNF	25/50

YATO	Ø [mm]	Thread size / Rozmiar gwintu	
YT-3338	83	5/8" (16.0 mm) 18UNF	25/50
YT-3343	95	5/8" (16.0 mm) 18UNF	25/50
YT-3345	102	5/8" (16.0 mm) 18UNF	10/20
YT-3346	105	5/8" (16.0 mm) 18UNF	10/20
YT-3349	114	5/8" (16.0 mm) 18UNF	10/20
YT-3350	121	5/8" (16.0 mm) 18UNF	10/20
YT-3351	127	5/8" (16.0 mm) 18UNF	10/20
YT-3353	140	5/8" (16.0 mm) 18UNF	10/20

- EN TCT hole saw for metal
PL Otwornica TCT do metalu
DE TCT Lochsäge für Metall
RU Кольцевая пила TCT по металлу
CZ Kruhový vrták TCT do kovu
HU TCT körkivágó fémhez
- RO Carota TCT pt. metal
FR Scie-trépan TCT pour le métal
IT Sega a tazza TCT per metallo
ES Sierra de corona TCT para metal
CN TCT金属开孔器

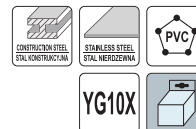

YATO	Ø [mm]	Hex	Box
YT-44050	16	1/4" (6.3 mm)	10/100
YT-44051	18	1/4" (6.3 mm)	10/100
YT-44052	19	1/4" (6.3 mm)	10/100
YT-44053	20	1/4" (6.3 mm)	10/100
YT-44054	22	1/4" (6.3 mm)	10/100
YT-44055	24	1/4" (6.3 mm)	10/100
YT-44056	25	1/4" (6.3 mm)	10/100
YT-44057	29	1/4" (6.3 mm)	10/100
YT-44058	30	1/4" (6.3 mm)	10/100

YATO	Ø [mm]	Hex	Box
YT-44059	32	1/4" (6.3 mm)	10/100
YT-44060	35	1/4" (6.3 mm)	10/100
YT-44061	38	1/4" (6.3 mm)	10/100
YT-44062	40	1/4" (6.3 mm)	10/100
YT-44063	44	3/8" (10.0 mm)	6/60
YT-44064	45	3/8" (10.0 mm)	6/60
YT-44065	50	3/8" (10.0 mm)	6/60
YT-44066	51	3/8" (10.0 mm)	6/60
YT-44067	54	3/8" (10.0 mm)	6/60

YATO	Ø [mm]	Hex	Box
YT-44068	55	3/8" (10.0 mm)	6/60
YT-44069	60	3/8" (10.0 mm)	6/60
YT-44070	65	3/8" (10.0 mm)	6/48
YT-44071	70	3/8" (10.0 mm)	6/48
YT-44072	80	3/8" (10.0 mm)	4/24
YT-44073	90	3/8" (10.0 mm)	4/24
YT-44074	102	3/8" (10.0 mm)	4/24

- EN Arbor for hole saw
PL Uchwyt do otwornic
DE Halterung für Lochsägen
RU Держатель универсальных коронок
CZ Šroubový unášec pro vrtací korunky
HU Befogószer a koronafúróhoz

- RO Dispozitiv de antrenare pt. găurătorii bimetalici
FR Mandrin aux scies-trépan
IT Alberino per seghe a tazza
ES Adaptador para sierra de corona
CN 孔锯柄轴

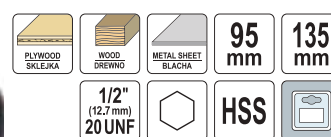

YATO	Ø [mm]	Toolholder type / Rodzaj uchwytu narzędziowego	Thread size / Rozmiar gwintu	Box
YT-43992	6	HEX	1/2" (12.5 mm) 20UNF	20/100

- EN Arbor for hole saw
PL Uchwyt do otwornic
DE Halterung für Lochsägen
RU Держатель универсальных коронок
CZ Šroubový unášec pro vrtací korunky
HU Befogószer a koronafúróhoz

- RO Dispozitiv de antrenare pt. găurătorii bimetalici
FR Mandrin aux scies-trépan
IT Alberino per seghe a tazza
ES Adaptador para sierra de corona
CN 孔锯柄轴

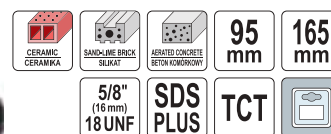

YATO	Ø [mm]	Toolholder type / Rodzaj uchwytu narzędziowego	Thread size / Rozmiar gwintu	Box
YT-43990	8	SDS-Plus	5/8" (16.0 mm) 18UNF	10/90

- EN Arbor for hole saw
PL Uchwyt do otwornic
DE Halterung für Lochsägen
RU Держатель универсальных коронок
CZ Šroubový unášec pro vrtací korunky
HU Befogószer a koronafúróhoz

- RO Dispozitiv de antrenare pt. găurătorii bimetalici
FR Mandrin aux scies-trépan
IT Alberino per seghe a tazza
ES Adaptador para sierra de corona
CN 孔锯柄轴

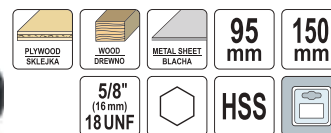

YATO	Ø [mm]	Toolholder type / Rodzaj uchwytu narzędziowego	Thread size / Rozmiar gwintu	Box
YT-43991	6	HEX	5/8" (16.0 mm) 18UNF	10/90

- EN Extension bar
PL Przedłużka
DE Verlängerung
RU Удлинитель для воротка
CZ Prodlužovací přípravek
HU Toldalék

- RO Prelungitor
FR Rallonge
IT Prolunga
ES Tubo de prolongación
CN 延长接杆



YATO	Toolholder type / Rodzaj uchwytu narzędziowego	H [mm]	Box
YT-43993	sześciokątny, SDS-Plus	300	10/50

- EN Pilot drill
PL Wiertło pilot
DE Pilotbohrer
RU Сверло пилот
CZ Středící vrták
HU Központfúró

- RO Burghiu pilot
FR Foret - pilot
IT Punta pilota
ES Broca piloto
CN 导向钻



YATO	Ø [mm]	H [mm]	Box
YT-43994	6	95	50/250

- EN Pilot drill
PL Wiertło pilot
DE Pilotbohrer
RU Сверло пилот
HU Központfúró

- RO Burghiu pilot
FR Foret - pilot
IT Punta pilota
ES Broca piloto
CN 导向钻



YATO	Ø [mm]	H [mm]	Box
YT-43995	8	95	50/250

EN Arbor for hole saw
 PL Uchwyt do otwornic
 DE Halterung für Lochsägen
 RU Держатель коронок
 CZ Šroubový unášec pro vrtací korunky
 HU Befogószer a koronafúróhoz
 RO Burghiu pt. ghidare freză bimetalică
 FR Mandrin aux scies-trépan
 IT Alberino per seghe a tazza
 ES Adaptador para sierra de corona
 CN 孔锯柄轴

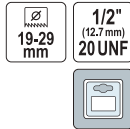

EN Arbor for hole saw
 PL Uchwyt do otwornic
 DE Halterung für Lochsägen
 RU Держатель коронок
 CZ Šroubový unášec pro vrtací korunky
 HU Befogószer a koronafúróhoz
 RO Burghiu pt. ghidare freză bimetalică
 FR Mandrin aux scies-trépan
 IT Alberino per seghe a tazza
 ES Adaptador para sierra de corona
 CN 孔锯柄轴

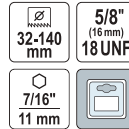

EN Arbor for hole saw
 PL Uchwyt do otwornic
 DE Halterung für Lochsägen
 RU Держатель коронок
 CZ Šroubový unášec pro vrtací korunky
 HU Befogószer a koronafúróhoz
 RO Burghiu pt. ghidare freză bimetalică
 FR Mandrin aux scies-trépan
 IT Alberino per seghe a tazza
 ES Adaptador para sierra de corona
 CN 孔锯柄轴



YATO Toolholder type / Rodzaj uchwytu narzędziowego		
YT-3370	sześciokątny	25/100
YT-3373	SDS-Plus	25/100

YATO Toolholder type / Rodzaj uchwytu narzędziowego		
YT-3371	sześciokątny	25/100

YATO Toolholder type / Rodzaj uchwytu narzędziowego		
YT-3372	sześciokątny	25/50
YT-3374	SDS-Plus	25/50

EN Pilot drill
 PL Wiertko pilot
 DE Pilotbohrer
 RU Сверло пилот

CZ Středící vrták
 HU Központfúró
 RO Burghiu pilot
 FR Foret - pilot

IT Punta pilota
 ES Broca piloto
 CN 导向钻



YATO	Ø [mm]	H [mm]	
YT-3377	6	100	25/100

EN Electrician's hole saw kit
 PL Zestaw otwornic dla elektryków
 DE Lochsägensatz für Elektriker
 RU Набор ножовок к отверстиям для электриков
 CZ Sada vrtacích korunek pro elektrikáře
 HU Koronafúró készlet villanyszerelőknek
 RO Set freze bimetalice
 FR Set de scies trépan aux électriciens
 IT Set universale a tazza fresa con strumenti
 ES Juego de sierras de marquetería para electricistas
 CN 双金属开孔器组套

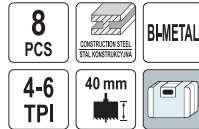

EN Combination hole saw kit
 PL Uniwersalny zestaw otwornic
 DE Universal-Lochsägensatz
 RU Универсальный набор ножовок к отверстиям
 CZ Univerzální sada vrtacích korunek
 HU Univerzális koronafúró készlet
 RO Set freze bimetalice
 FR Set de scies trépan universelles
 IT Set universale a tazza fresa con strumenti
 ES Juego universal de sierras de marquetería
 CN 双金属开孔器组套

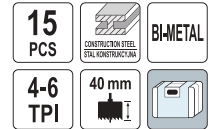

YATO	Ø [mm]	
YT-3380	22, 29, 35, 44, 67, 73	10



YATO	Ø [mm]	
YT-3381	19, 22, 25, 32, 35, 38, 44, 51, 57, 64, 76	5

EN TCT hole saw set
 PL Zestaw otwornic TCT do metalu
 DE TCT Lochsägeset für Metall
 RU Набор кольцевых пил TCT по металлу
 CZ Sada korunkových vrtáků TCT do kovu
 HU TCT körkivágó készlet fémhez
 RO Set carote TCT
 FR Ensemble de scies-trépan TCT pour le métal
 IT Kit di seghe a tazza TCT per metallo
 ES Juego de sierras de corona TCT para metal
 CN TCT金属开孔器组套



YATO	Ø [mm]		
YT-44077	22, 30, 35, 45, 50, 65	1/4" (6.3 mm), 3/8" (10.0 mm)	12

EN Combined drill tap
PL Wiertło-gwintownik
DE Gewindebohrer Bit
RU Сверло метчик
CZ Bitový kombinovaný závitník
HU Fűrő-menetfűrő bit befogású

RO Burghiu tarod Hex
FR Fraise à tarauds combinés
IT Punte madreviti
ES Broca roscadora Hex
CN 六角柄复合丝锥

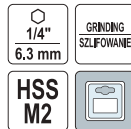

EN Combined drill taps hex set
PL Zestaw wiertel-gwintowników Hex
DE Gewindebohrer Bit Satz
RU Набор сверл метчиков Hex
CZ Sada bitový kombinovaný závitník Hex
HU Fűrő-menetfűrő bit befogású Hex
RO Set burghiu tarod Hex
FR Kit de mèches fraise à tarauds combinés Hex
IT Set di punte madreviti esagonali
ES Juego de brocas roscadoras Hex
CN 六角柄复合丝锥组套

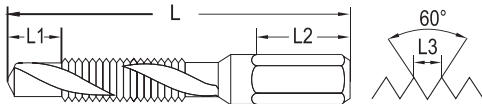

1/4" (6.3 mm)

YATO	Size / Rozmiar	L [mm]	L1 [mm]	L2 [mm]	L3 [mm]	
YT-44840	M3	36	5	14	0.5	20/200
YT-44841	M4	39	6	14	0.7	20/200
YT-44842	M5	41	7	14	0.8	20/200
YT-44843	M6	44	8	14	1.0	20/200
YT-44845	M8	51	11	14	1.3	20/200
YT-44847	M10	59	15	14	1.5	20/200

YATO	Size / Rozmiar	
YT-44849	M3, M4, M5, M6, M8, M10	5/60

EN Hand tap
PL Gwintownik ręczny
DE Handgewindebohrer
RU Ручной метчик
CZ Závitník
HU Menetfűrő

RO Tarozi
FR Taraud à main
IT Maschi filettatura a mano
ES Machos de roscar
CN 三件套用手丝锥

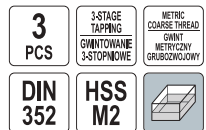

YATO	Size / Rozmiar	Thread pitch / Skok gwintu [mm]	Thread length / Długość gwintu [mm]	L [mm]	Shank diameter / Średnica trzonu [mm]	pcs / szt.	m [g]
YT-2930	M3	0.5	11	40	3.5	3	25
YT-2931	M4	0.7	13	45	4.5	3	35
YT-2932	M5	0.8	16	50	6.0	3	45
YT-2933	M6	1.0	19	50	6.0	3	45
YT-2934	M7	1.0	19	50	6.0	3	55
YT-2935	M8	1.3	22	56	6.0	3	60
YT-2937	M10	1.5	24	70	7.0	3	85
YT-2939	M12	1.8	29	75	9.0	3	125
YT-2940	M14	2.0	30	80	10.5	3	200
YT-2941	M16	2.0	32	80	11.0	3	235
YT-2942	M18	2.5	40	95	12.0	3	345
YT-2943	M20	2.5	40	95	14.0	3	445

EN Machine tap
PL Gwintownik maszynowy
DE Maschinengewindebohrer
RU Машинный метчик
CZ Strojní závitník
HU Gépi menetfűrő

RO Tarod de mașină
FR Taraud machine
IT Maschi filettatura
ES Macho mecanico
CN 机用丝锥

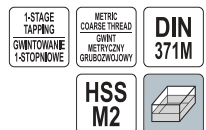
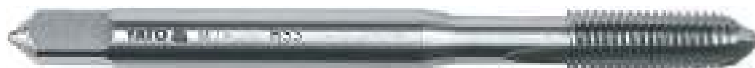

YATO	Size / Rozmiar	Thread pitch / Skok gwintu [mm]	Thread length / Długość gwintu [mm]	L [mm]	Shank diameter / Średnica trzonu [mm]	m [g]
YT-2950	M3	0.5	11	56	3.5	15
YT-2951	M4	0.7	13	63	4.5	20
YT-2952	M5	0.8	16	70	6.0	25
YT-2953	M6	1.0	19	80	6.0	30
YT-2954	M7	1.0	19	80	7.1	35
YT-2955	M8	1.3	22	90	8.0	45
YT-2956	M10	1.5	24	100	10.0	65

EN Machine tap
PL Gwintownik maszynowy
DE Maschinengewindebohrer
RU Машинный метчик
CZ Strojní závitník
HU Gépi menetfűrő

RO Tarod de mașină
FR Taraud machine
IT Maschi filettatura
ES Macho mecanico
CN 机用丝锥



YATO	Size / Rozmiar	Thread pitch / Skok gwintu [mm]	Thread length / Długość gwintu [mm]	L [mm]	Shank diameter / Średnica trzonu [mm]	m [g]
YT-2944	M12	1.8	29	110	9	70
YT-2945	M14	2.0	30	110	11	110
YT-2946	M16	2.0	32	110	12	120

EN Tap and die set
 PL Zestaw narzynek i gwintowników
 DE Gewindeschneidwerkzeug-Satz
 RU Набор плашек и метчиков
 CZ Souprava závitníků a kruhových závitových čelistí
 HU Menetfűrös és menetvágó készlet
 RO Set de tarozi și filiere
 FR Set de filières et tarauds
 IT Set di filiera a maschi
 ES Juego de machos de roscar y cojinetes
 CN 丝锥板牙组套

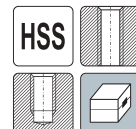

32
PCS

DIN
223
352

YATO	Size / Rozmiar	
YT-2975	M3, M4, M5, M6, M8, M10, M12	10



44
PCS

DIN
223
225
338
352
DIN1814



YATO	Size / Rozmiar	
YT-2978	M3, M4, M5, M6, M8, M10, M12	4



56
PCS

DIN
223
225
338
352
DIN1814

YATO	Size / Rozmiar	
YT-2979	M3, M4, M5, M6, M8, M10, M12, M14, M16, M18, M20	2

10

EN Tap set
 PL Zestaw gwintowników
 DE Gewindeschneidwerkzeug-Satz
 RU Набор метчиков
 CZ Souprava závitníků
 HU Menetfűrös készlet
 RO Set de tarozi
 FR Set de tarauds
 IT Set di filettature
 ES Juego de machos de roscar
 CN 公制丝锥组套

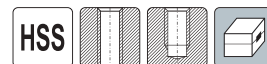

21
PCS

DIN
352

YATO	Size / Rozmiar	
YT-2976	M3, M4, M5, M6, M8, M10, M12	20



29
PCS

DIN
338
352
1814



YATO	Size / Rozmiar	
YT-2977	M3, M4, M5, M6, M8, M10, M12	12

EN Circular die
 PL Narzynka
 DE Schneideisen
 RU Плашка
 CZ Kruhová závitová čelist
 HU Menetvágó
 RO Filieră
 FR Filière
 IT Filiera tonde filettatura
 ES Cojinete de roscar
 CN 圆板牙



YATO	Size / Rozmiar	Thread pitch / Skok gwintu [mm]	External diameter / Średnica zewnętrzna [mm]	Thickness / Grubość [mm]	m [g]	
YT-2961	M4	0.7	20	5	20	125/500
YT-2962	M5	0.8	20	7	20	100/400
YT-2963	M6	1.0	20	7	20	100/400
YT-2964	M7	1.0	25	9	35	100/200
YT-2965	M8	1.3	25	9	35	100/400
YT-2967	M10	1.5	30	11	50	70/280
YT-2969	M12	1.8	38	14	90	60/240
YT-2970	M14	2.0	45	18	160	50/200
YT-2971	M16	2.0	45	18	150	50/200
YT-2973	M20	2.5	55	22	300	20/80
YT-2966	M24	3.0	55	22	300	20/80

EN Step drill
PL Wiertło stopniowe
DE Stufenbohrer
RU Сверло ступенчатое
CZ Stupňovitý vrták
HU Lépcsős fúró

RO Burghiu in trepte
FR Foret étagé
IT Punta a gradini
ES Broca cónica escalonada
CN 阶梯钻



TITANIUM COATED
POWŁOKA
TYTANOWA

HSS
4241

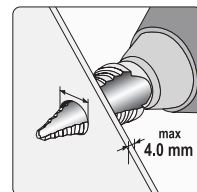

YATO	Steps quantity / Liczba stopni	Ø [mm]	L [mm]	Working length / Długość robocza [mm]	
YT-44743	7	14, 16, 18, 20, 22, 24, 26	70	40	100
YT-44742	8	10, 15, 20, 25, 30, 35, 40, 45	100	75	40
YT-44741	10	4, 6, 8, 10, 12, 14, 16, 18, 20, 22	75	52	25/50
YT-44739	10	6, 10, 13, 16, 19, 22, 25, 29, 32, 35	75	45	10/80
YT-44744	10	6, 12, 13, 14, 15, 16, 17, 18, 19, 20	75	55	20/200
YT-44745	11	10, 11, 12, 13, 14, 15, 16, 17, 18, 19, 20	75	52	20/200
YT-44747	11	20, 21, 22, 23, 24, 25, 26, 27, 28, 29, 30	75	54	12/96
YT-44746	12	10, 20, 21, 22, 23, 24, 25, 26, 27, 28, 29, 30	87	60	12/96
YT-44740	12	6, 8, 11, 14, 17, 20, 23, 26, 29, 32, 35, 38	105	78	10/60

EN Step drill set
PL Zestaw wiertel stopniowych
DE Stufenbohrer Set
RU Набор ступенчатых сверл
CZ Sada stupňovitých vrtáků
HU Lépcsős fúró készlet
RO Set burghie in trepte
FR Jeu de forets étagés
IT Set di punte a gradino
ES Juego de brocas cónicas escalonadas
CN 阶梯钻组套

3
PCS

Ø
3-20
mm

HSS
4241

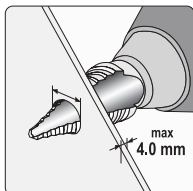

YATO	Ø [mm]	
YT-44731	3-12 (3, 4, 5, 6, 7, 8, 9, 10, 11, 12 mm), 4-12 (4, 6, 8, 10, 12 mm), 4-20 (4, 6, 8, 10, 12, 14, 16, 18, 20 mm)	40

EN Taper drill set
PL Zestaw wiertel stożkowych
DE Blechschräbbohrer-Satz
RU Набор ступенчатых сверл
CZ Sada kuželových vrtáků do plechu
HU Részecs lemezfúró készlet
RO Set alezoare in trepte
FR Set de perceuse taper
IT Set di punte coniche
ES Conjunto brocas cónicas
CN 薄板钻

3
PCS

Ø
3-30
mm

HSS
4241

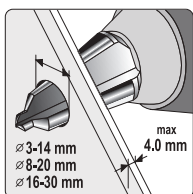

YATO	Ø [mm]	
YT-44730	3-14, 8-20, 16-30	10/30

EN Step drill set
PL Zestaw wiertel stopniowych
DE Stufenbohrer Set
RU Набор ступенчатых сверл
CZ Sada stupňovitých vrtáků
HU Lépcsős fúró készlet
RO Set burghie in trepte
FR Jeu de forets étagés
IT Set di punte a gradino
ES Juego de brocas cónicas escalonadas
CN 阶梯钻组套

3
PCS

Ø
4-38
mm

HSS
4241

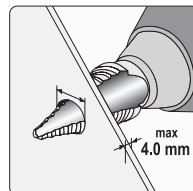

YATO	Ø [mm]	
YT-44732	4-12 (4, 6, 8, 10, 12 mm), 4-22 (4, 6, 8, 10, 12, 14, 16, 18, 20, 22 mm), 6-38 (6, 8, 11, 14, 17, 20, 23, 26, 29, 32, 35, 38 mm)	6/24

EN Countersink
PL Pogłębiacz
DE Kegelsenker
RU Конусный зенкер
CZ Kuželový záhlubník
HU Kúpos sülyesztő

RO Zencuitor
FR Fraise conique
IT Accettatoio
ES Avellanador cónico
CN 倒角器

STEEL
STAL

1/4"
6,3 mm

45°

5
BLADES
OSTRZA

HSS



YATO	Ø [mm]	L [mm]	
YT-44721	6.3	40	50/200
YT-44722	8.3	40	50/200
YT-44723	10.4	40	50/200
YT-44724	12.4	40	50/200
YT-44725	16.5	45	25/100
YT-44726	20.5	45	25/100

- EN Countersink set
- PL Zestaw pogłębiaczy do metalu
- DE Kegelsenker-Satz
- RU Конусный зенкер
- CZ Kuželový záhlubník
- HU Kúpos süllyesztő
- RO Zenculior
- FR Fraise conique
- IT Set di svasatori per metallo
- ES Avellanador cónico
- CN 倒角器组套



6 PCS

1/4" 6.3 mm

5 BLADES OSTRZA **HSS**

- EN T-handle tap wrench
- PL Pokrętko typu „T” do gwintowników
- DE Gewinde-Werkzeughalter
- RU Рукотка типа „Т” к гаечным ключам
- CZ Vratidlo na závitníky typ „T”
- HU Menetfűró befogó T-nyelű
- RO Port tarod cu maner
- FR Porte-taraud type „T”
- IT Chiave giramaschio tipo „T” per maschi
- ES Llave giramachos „T”
- CN 丝锥扳手



YATO	Size / Rozmiar	L [mm]	
YT-2986	M3-M8	70	20/80
YT-2987	M5-M10	80	20/80
YT-2988	M6-M12	90	20/80

YATO	Ø [mm]	
YT-44729	6.3, 8.3, 10.4, 12.4, 16.5, 20.5	20

- EN Ratchet tap wrench
- PL Grzechotka do gwintownika
- DE Gewinde-Werkzeughalter
- RU Трещетка для метчика
- CZ Ráčnové vratidlo pro závitníky
- HU Racsnis hajtószer menetfűróhoz
- RO Port tarod
- FR Porte-taraud à cliquet
- IT Chiave giramaschi a cricchetto
- ES Carraca para macho de roscar
- CN 棘轮丝锥扳手



YATO	Size / Rozmiar	L [mm]	
YT-2989	M3-M10	85	20/80
YT-2997	M3-M10	250	20/80
YT-2990	M5-M12	100	20/80
YT-2991	M5-M12	300	20/40

- EN Die handle
- PL Oprawa do narzynek
- DE Schneideisenhalter
- RU Плшкодержатель
- CZ Závitová objímka
- HU Menetvágó tartó
- RO Portfilieră
- FR Porte-filière
- IT Porta filiere
- ES Portacojinete
- CN 板牙扳手

DIN 225



YATO	Size / Rozmiar	External diameter / Średnica zewnętrzna [mm]	Thickness / Grubość [mm]	L [mm]	
YT-2980	M3-M4	20	5	200	25/100
YT-2981	M4.5-M6	20	7	200	25/100
YT-2982	M7-M9	25	9	224	25/100
YT-2983	M10-M11	30	11	280	25/50
YT-2984	M12-M14	38	14	315	15/30
YT-2985	M16-M20	45	18	450	10/20

- EN Tap wrench
- PL Pokrętko do gwintowników
- DE Gewinde-Werkzeughalter
- RU Вороток для метчиков
- CZ Ovládací kolečko na závitník
- HU Hajtószer menetfűróhoz
- RO Cheie (măner) pt. tarod
- FR Porte-taraud
- IT Manopola per il maschio
- ES Llave giramachos
- CN 一型丝锥扳手



DIN 1814

YATO	Size / Rozmiar	L [mm]	
YT-2995	M1-M8	125	50/200
YT-2996	M3-M10	180	25/100
YT-2992	M3-M12	200	25/100
YT-2993	M4-M12	280	25/100
YT-2994	M5-M20	375	20/40

- EN Plug & forstener cutter
- PL Flekownik-sekownik do drewna
- DE Zapfenschneider und Forstnerbohrer für Holz
- RU Сверла по дереву: коронка и фреза
- CZ Kotočový vykrajovač-sukovník do dřeva
- HU Csapmaró-fűró szerszám fához
- RO Set burghie reparat lemn
- FR Ensemble pour réparation des nœuds dans le bois
- IT Punta forstner per legno
- ES Broca fresadora para madera
- CN 木塞钻和平翼钻组套

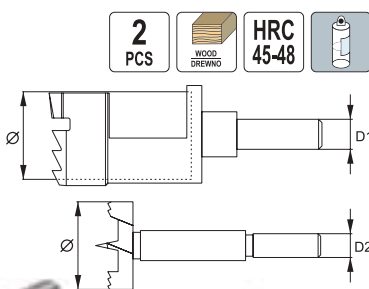

YATO	Ø [mm]	D1 [mm]	D2 [mm]	
YT-33830	15	10	8	10/100
YT-33831	20	12	8	10/100
YT-33832	25	12	8	10/100
YT-33833	30	12	8	10/60
YT-33834	35	12	10	10/60

- EN Plug & forstener cutter set
- PL Zestaw flekowników-sekowników do drewna
- DE Zapfenschneider und Forstnerbohrer-Set für Holz
- RU Набор сверл по дереву: коронки и фрезы
- CZ Sada kotočových vykrajovačů-sukovníků do dřeva
- HU Csapmaró-fűró szerszámkészlet fához
- RO Set burghie reparat lemn
- FR Ensemble pour réparation des nœuds dans le bois
- IT Set di punte forstner per legno
- ES Juego de brocas fresadoras para madera
- CN 木塞钻和平翼钻组套

10 PCS

8,10 mm

10,12 mm

HRC 45-48

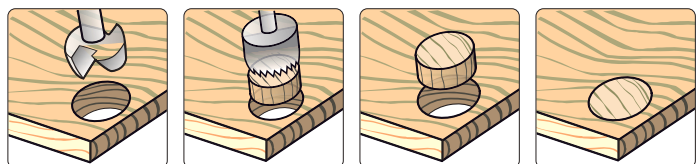

YATO	Ø [mm]	
YT-33837	15, 20, 25, 30, 35	20

EN Rotary file
PL Tarnik trzpieniowy
DE Profil-Fräser
RU Набор фасонных фрез
CZ Hrotové rašple
HU Fareszelőkészlet, csapszárás
RO Raspeluri cu coadă
FR Fichiers rotary
IT Fresa a gradino per metallo
ES Arquivos rotary
CN 旋转锉

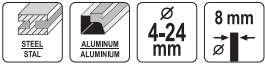
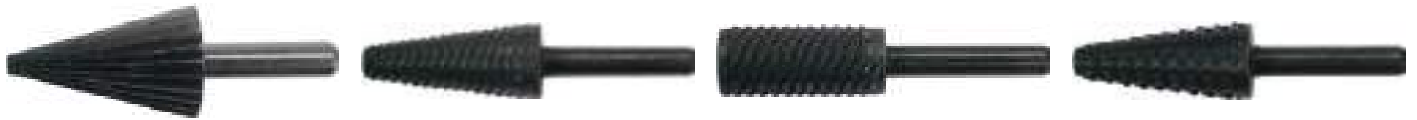
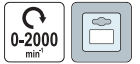

YATO	Ø [mm]	
YT-61700	4-24	10/120



YATO	Ø [mm]	
YT-61701	6-15	10/120

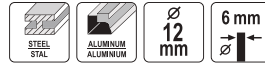

YATO	Ø [mm]	
YT-61702	12	10/120



YATO	Ø [mm]	
YT-61703	6-15	10/120



YATO	Ø [mm]	
YT-61704	13	10/120



YATO	Ø [mm]	
YT-61705	15	10/120



YATO	Ø [mm]	
YT-61706	20	10/120



YATO	Ø [mm]	
YT-61707	25	10/120

EN Rotary file for metal
PL Frez trzpieniowy do metalu
DE Schafffräser für Metall
RU Концевая фреза по металлу
CZ Stopková fréza na kov
HU Végmaró férnhez
RO Freza pt. metal
FR Fraise en bout pour le métal
IT Fresa a candela per metallo
ES Fresa de extremo para metal
CN 硬质合金旋转锉

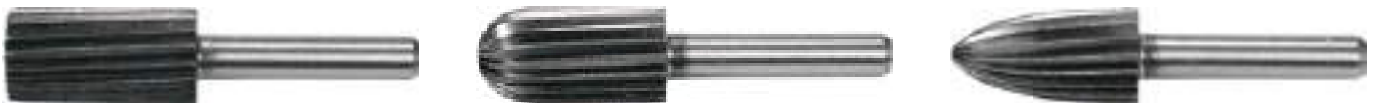

YATO	Ø [mm]	
YT-61714	13	80



YATO	Ø [mm]	
YT-61715	13	80



YATO	Ø [mm]	
YT-61716	13	80

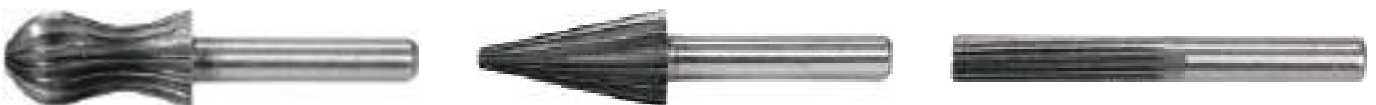

YATO	Ø [mm]	
YT-61717	13	80



YATO	Ø [mm]	
YT-61718	13	80



YATO	Ø [mm]	
YT-61719	6	80

EN Rotary file set
PL Tarniki trzpieniowe
DE Profil-Fräser Satz
RU Набор фрез
CZ Hrotové rašple
HU Fareszelőkészlet, csapszárás
RO Raspeluri cu coadă
FR Ensemble de fichiers rotary
IT Set di frese
ES Rotatorio archivos
CN 旋转锉

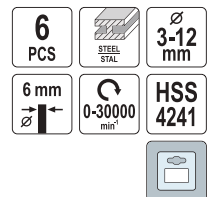

YATO	Ø [mm]	
YT-61711	3-15	12/48

EN Rotary file for metal
 PL Frez trzpieniowy do metalu
 DE Schafffräser für Metall

RU Концевая фреза по металлу
 CZ Stopková fréza na kov
 HU Végmaró fémhez

RO Freza pt. metal
 FR Fraise en bout pour le métal
 IT Fresa a candela per metallo

ES Fresa de extremo para metal
 CN 硬质合金旋转锉

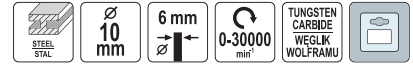

56 mm



YATO	Ø [mm]	
YT-61722	10	40/80

56 mm



YATO	Ø [mm]	
YT-61723	10	40/80

58 mm



YATO	Ø [mm]	
YT-61724	10	40/80

45 mm

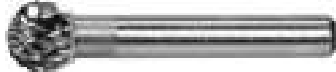

YATO	Ø [mm]	
YT-61725	10	40/80

58 mm



YATO	Ø [mm]	
YT-61726	10	40/80

50 mm



YATO	Ø [mm]	
YT-61727	10	40/80

EN Rotary file set for metal premium
 PL Zestaw frezów trzpieniowych do metalu premium
 DE Schafffräser für metall Premium
 RU Концевые фрезы по металлу премиум
 CZ Stopkové frézy do kovu premium
 HU Marószárak fémhez prémium
 RO Set freze metal
 FR Fraises à mandrin pour métal premium
 IT Set di frese con codolo per metalli premium
 ES Fresas para metal premium
 CN 硬质合金旋转锉

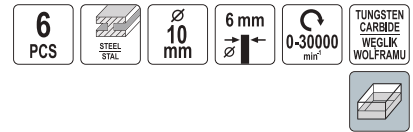

YATO	Ø [mm]	L [mm]	
YT-61729	10	45, 50, 56, 56, 58, 58	20/40

EN Rotary file set
 PL Tarniki trzpieniowe
 DE Profil-Fräser Satz
 RU Набор фрез
 CZ Hrotové rašple
 HU Fareszelőkészlet, csapszárás
 RO Raşpeluri cu coadă
 FR Ensemble de fichiers rotary
 IT Set di frese
 ES Rotatorio archivos
 CN 旋转锉

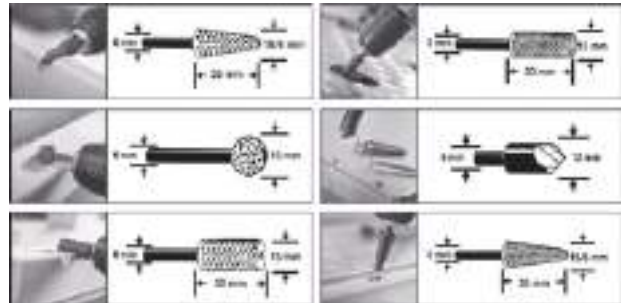

YATO	Ø [mm]	
YT-61712	6-15	10/60

EN Forstner drill bit
 PL Wiertło do drewna pod zawiasy
 DE Forstnerbohrer
 RU Сверло форстнера по дереву
 CZ Karbidový vrták na vrtání otvorů pro závěsy
 HU Forstner fúrószer fához
 RO Freza pt. lemn
 FR Mèche de perceuse à bois
 IT Punta per legno per cerniere
 ES Broca para bisagras
 CN 木工开孔器



YATO	Ø [mm]	
YT-33010	26	10/100
YT-33011	35	10/100

EN Forstner drill bit set
 PL Zestaw wiertel do drewna pod zawiasy
 DE Forstnerbohrer Set
 RU Сверло форстнера по дереву
 CZ Sada karbidový vrták na vrtání otvorů pro závěsy
 HU Forstner fúrószer készlet fához
 RO Set freze pt. lemn
 FR Mèches de perceuse à bois
 IT Set di punte per legno per cerniere
 ES Juego de brocas para bisagras
 CN 木工开孔器组套



YATO	Ø [mm]	
YT-33015	15, 20, 26, 30, 35	20

EN Router bit set
PL Zestaw frezów do drewna
DE Oberfrärsersatz
RU Набор фрез по дереву

CZ Souprava frézů do dřeva
HU Medtjo frezř kompletas
RO Set de freze pt. lemn
FR Fraises pour le bois

IT Set di frese per legno
ES Juego de frezas para madera
CN 木工铣刀组套

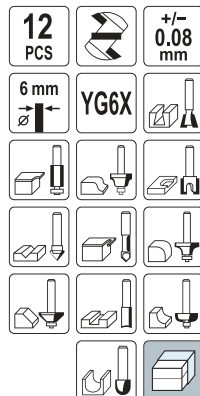

Router bit parameter												
shank diameter / średnica uchwyty [mm]	6.0	6.0	6.0	6.0	6.0	6.0	6.0	6.0	6.0	6.0	6.0	6.0
length / długość [mm]	51.0	49.0	51.0	45.0	48.0	48	50.0	53.0	50.0	52.0	38.0	39.0
router bit diameter / średnica frezu [mm]	6.0	12.0	16.0	12.7	32.0	22.0	25.4	28.6	22.0	12.7	13.0	12.7
cutting edge length / długość krawędzi tnącej [mm]	20.0	20.0	20.0	12.7	12.7	10.5	11.5	16.0	12.0	13.0	9.5	6.35
curvature radius / promień krzywizny [mm]	-	-	-	-	-	12.7	3.175	9.5	6.35	-	-	-
bearing diameter / średnica łożyska [mm]	-	-	-	-	9.0	9.0	9.0	9.0	9.0	9.0	-	-
angle / kąt [°]	-	-	-	10.0	45.0	-	-	-	-	-	90.0	-



YATO
YT-68006 20

EN Router bit set
PL Zestaw frezów do drewna
DE Oberfrärsersatz
RU Набор фрез по дереву

CZ Souprava frézů do dřeva
HU Medtjo frezř kompletas
RO Set de freze pt. lemn
FR Fraises pour le bois

IT Set di frese per legno
ES Juego de frezas para madera
CN 木工铣刀组套

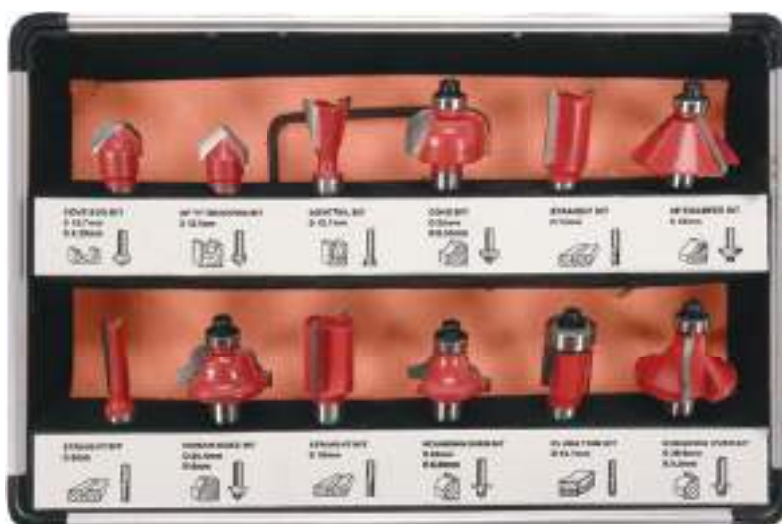

Router bit parameter												
shank diameter / średnica uchwyty [mm]	8.0	8.0	8.0	8.0	8.0	8.0	8.0	8.0	8.0	8.0	8.0	8.0
length / długość [mm]	51.0	49.0	51.0	45.0	48.0	48	50.0	53.0	50.0	52.0	38.0	39.0
router bit diameter / średnica frezu [mm]	6.0	12.0	16.0	12.7	32.0	22.0	25.4	28.6	22.0	12.7	13.0	12.7
cutting edge length / długość krawędzi tnącej [mm]	20.0	20.0	20.0	12.7	12.7	10.5	11.5	16.0	12.0	13.0	9.5	6.35
curvature radius / promień krzywizny [mm]	-	-	-	-	-	12.7	3.175	9.5	6.35	-	-	-
bearing diameter / średnica łożyska [mm]	-	-	-	-	9.0	9.0	9.0	9.0	9.0	9.0	-	-
angle / kąt [°]	-	-	-	10.0	45.0	-	-	-	-	-	90.0	-



YATO
YT-68005 20

EN Router bit set
 PL Zestaw frezów do drewna
 DE Oberfrärsersatz
 RU Набор фрез по дереву

CZ Souprava frézů do dřeva
 HU Medtjio frezř kompletas
 RO Set de freze pt. lemn
 FR Fraises pour le bois

IT Set di frese per legno
 ES Juego de frezas para madera
 CN 木工铣刀组套



15 PCS

6 mm

YG6X

+/- 0.08 mm

Router bit parameter															
shank diameter / średnica uchwyty [mm]	6.0	6.0	6.0	6.0	6.0	6.0	6.0	6.0	6.0	6.0	6.0	6.0	6.0	6.0	6.0
length / długość [mm]	43.0	49.0	51.0	45.0	48.0	51.0	50.0	53.0	50.0	52.0	38.0	39.0	49.0	60.0	43.0
router bit diameter / średnica frezu [mm]	12.7	12.0	16.0	12.7	32.0	6.0	25.4	28.6	22.0	12.7	12.7	3.0	6.35	6.35	6.35
cutting edge length / długość krawędzi tnącej [mm]	12.7	20.0	20.0	12.7	12.7	20.0	11.5	16.0	12.0	13.0	9.5	6.35	13.0	19.50	6.0
curvature radius / promień krzywizny [mm]	-	-	-	-	-	-	3.175	9.5	6.35	-	-	-	-	-	3.2
bearing diameter / średnica łożyska [mm]	-	-	-	-	9.0	-	9.0	9.0	9.0	9.0	-	-	-	-	-
angle / kąt [°]	-	-	-	10.0	45.0	-	-	-	-	-	90	-	-	-	-



YATO

YT-68007

20

EN Router bit set
 PL Zestaw frezów do drewna
 DE Oberfrärsersatz
 RU Набор фрез по дереву

CZ Souprava frézů do dřeva
 HU Medtjio frezř kompletas
 RO Set de freze pt. lemn
 FR Fraises pour le bois

IT Set di frese per legno
 ES Juego de frezas para madera
 CN 木工铣刀组套

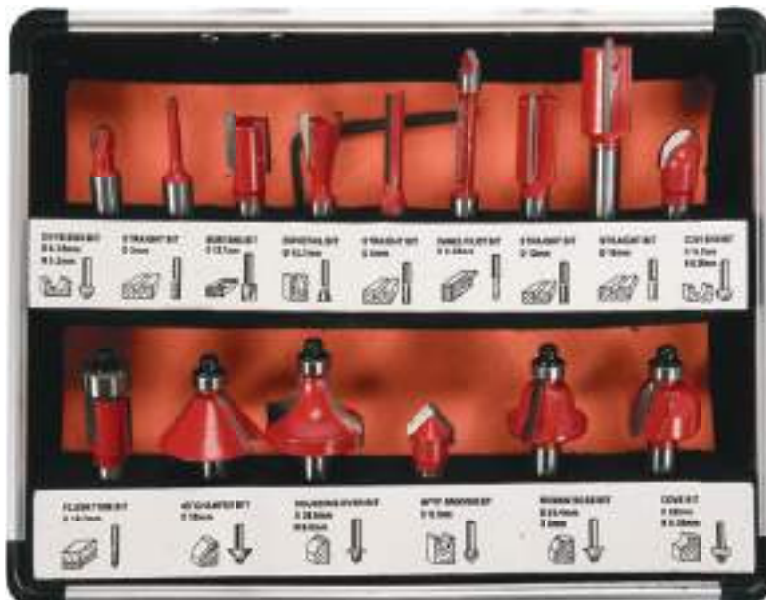

15 PCS

8 mm

YG6X

+/- 0.08 mm

Router bit parameter															
shank diameter / średnica uchwyty [mm]	8.0	8.0	8.0	8.0	8.0	8.0	8.0	8.0	8.0	8.0	8.0	8.0	8.0	8.0	8.0
length / długość [mm]	43.0	49.0	51.0	45.0	48.0	51.0	50.0	53.0	50.0	52.0	38.0	39.0	49.0	60.0	43.0
router bit diameter / średnica frezu [mm]	12.7	12.0	16.0	12.7	32.0	6.0	25.4	28.6	22.0	12.7	12.7	3.0	6.35	6.35	6.35
cutting edge length / długość krawędzi tnącej [mm]	12.7	20.0	20.0	12.7	12.7	20.0	11.5	16.0	12.0	13.0	9.5	6.35	13.0	19.50	6.0
curvature radius / promień krzywizny [mm]	-	-	-	-	-	-	3.175	9.5	6.35	-	-	-	-	-	3.2
bearing diameter / średnica łożyska [mm]	-	-	-	-	9.0	-	9.0	9.0	9.0	9.0	-	-	-	-	-
angle / kąt [°]	-	-	-	10.0	45.0	-	-	-	-	-	90	-	-	-	-











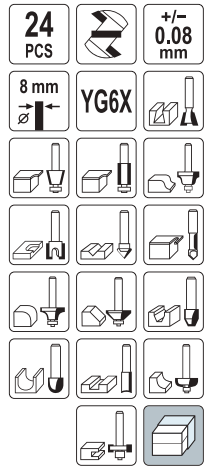



YATO













YT-68002

20

EN Router bit set
PL Zestaw frezów do drewna
DE Oberfrärsersatz
RU Набор фрез по дереву
CZ Souprava frézů do dřeva
HU Medítő frez komplextas
RO Set de freze pt. lemn
FR Fraises pour le bois
IT Set di frese per legno
ES Juego de frezas para madera
CN 木工铣刀组套



Router bit parameter												
Shank diameter [mm]	8	8	8	8	8	8	8	8	8	8	8	8
Length [mm]	42.0	47.0	47.0	43.5	50.0	51.5	51.0	52.0	58.0	51.5	58.0	56.5
Router bit diameter [mm]	12.7	12.7	9.5	12.7	12.7	9.5	12.7	16.0	6.35	6.35	9.5	12.7
Cutting edge length [mm]	12.7	14.8	11.6	13.0	12.5	20.0	20.0	9.5	19.5	20.0	24.5	25.0
Curvature radius [mm]	-	-	-	-	-	4.75	6.35	-	-	-	-	-
Bearing diameter [mm]	-	-	-	-	-	-	-	12.7	-	-	-	-
Angle [°]	-	15	10	-	45	-	-	15	-	-	-	-









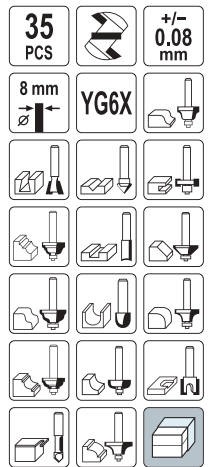





Router bit parameter												
Shank diameter [mm]	8	8	8	8	8	8	8	8	8	8	8	8
Length [mm]	52.0	65.0	51.0	51.5	53.5	57.5	50.5	53.5	52.0	55.0	50.0	54.0
Router bit diameter [mm]	19.0	12.7	19.0	22.0	26.0	32.0	22.0	28.5	27.0	30.0	32.0	32.0
Cutting edge length [mm]	20.4	25.0	9.5	10.0	11.5	16.5	9.72	13.5	12.3	14.0	6.35	12.7
Curvature radius [mm]	-	-	3.2	4.76	6.35	9.5	6.35	9.5	4.0	-	-	-
Bearing diameter [mm]	-	12.7	-	12.7	12.7	12.7	9.5	9.5	9.5	12.7	12.7	12.7
Angle [°]	-	-	-	-	-	-	-	-	45	-	-	-

















YATO 
YT-6801 
10

EN Router bit set
PL Zestaw frezów do drewna
DE Oberfrärsersatz
RU Набор фрез по дереву
CZ Souprava frézů do dřeva
HU Medítő frez komplextas
RO Set de freze pt. lemn
FR Fraises pour le bois
IT Set di frese per legno
ES Juego de frezas para madera
CN 木工铣刀组套



Router bit parameter																		
Shank diameter [mm]	8	8	8	8	8	8	8	8	8	8	8	8	8	8	8			
Length [mm]	43.0	38.0	38.0	50.5	42.0	43.5	51.5	49.5	51.5	58.0	58.5	56.5	52.0	58.0	53.5	66.0	53.0	65.0
Router bit diameter [mm]	6.35	12.7	12.7	12.7	12.7	12.7	14.3	3.175	6.35	9.5	12.7	12.7	19.0	6.35	9.5	9.5	12.7	12.7
Cutting edge length [mm]	6.0	9.5	9.5	18.0	12.7	13.0	12.3	13.0	20.0	24.5	20.3	25.0	20.4	19.5	15.0	26.0	15.0	25.0
Curvature radius [mm]	3.175	6.35	-	6.35	-	-	-	-	-	-	-	-	-	-	-	-	-	-
Bearing diameter [mm]	-	-	-	-	-	-	-	-	-	-	-	-	-	-	9.5	9.5	12.7	12.7
Angle [°]	-	-	45	-	-	10	14	-	-	-	-	-	-	-	-	-	-	-

Router bit parameter																		
Shank diameter [mm]	8	8	8	8	8	8	8	8	8	8	8	8	8	8	8	-		
Length [mm]	65.5	55.0	51.0	55.0	50.0	52.5	54.0	55.5	60.0	60.0	56.0	60.0	52.5	58.0	53.5	57.5	61.0	-
Router bit diameter [mm]	19.0	30.0	26.0	32.0	32.0	32.0	32.0	32.0	32.0	38.0	32.0	38.0	26.0	38.0	26.0	32.0	38.0	-
Cutting edge length [mm]	26.0	14.0	9.7	13.3	6.35	8.0	9.5	15.0	18.5	20.0	16.0	19.0	12.5	17.8	11.5	16.5	20.8	-
Curvature radius [mm]	-	-	6.35	9.5	-	-	-	8.0	4.76	12.7	4.76	6.35	3.175	6.35	6.35	9.5	12.7	-
Bearing diameter [mm]	19.0	12.7	12.7	12.7	12.7	12.7	12.7	9.5	12.7	9.5	9.5	9.5	9.5	9.5	12.7	12.7	12.7	-
Angle [°]	-	45	-	-	-	-	-	-	-	-	-	-	-	-	-	-	-	-



YATO 
YT-6803 
10

EN Diamond blade
 PL Tarcza diamentowa
 DE Diamant-Trennscheibe
 RU Отрезной алмазный диск
 CZ Diamantový kotouč
 HU Gyémántkorong
 RO Disc cu diamant
 FR Disque diamant
 IT Disco diamantato
 ES Disco de diamante
 CN 金刚石切片

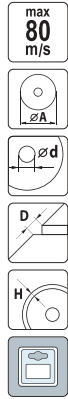

• Application: concrete, brick, tile, masonry, stone, sandstone, refractory materials, limestone
 • Przeznaczenie: beton utwardzony, cegła, granit, mur, kamień, piaskowiec, materiały ogniotrwałe, silikaty

YATO	ØA [mm]	Ød [mm]	max C [min ⁻¹]	D [mm]	H [mm]	
YT-59961	115	22.2	12000	1.8	10	20/200
YT-59962	125	22.2	12000	2.0	10	20/100
YT-59965	230	22.2	6500	2.2	10	25
YT-60003	350	25.4	4400	3.4	10	10
YT-60004	400	25.4	3850	3.6	10	5

EN Diamond blade
 PL Tarcza diamentowa
 DE Diamant-Trennscheibe
 RU Отрезной алмазный диск
 CZ Diamantový kotouč
 HU Gyémántkorong
 RO Disc cu diamant
 FR Disque diamant
 IT Disco diamantato
 ES Disco de diamante
 CN 热压湿片

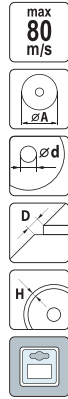

• Application: ceramic, glaze
 • Przeznaczenie: płytki ceramiczne, glazura, płytki kamienne

YATO	ØA [mm]	Ød [mm]	max C [min ⁻¹]	D [mm]	H [mm]	
YT-59951	115	22.2	12000	1.6	10	20/200
YT-59952	125	22.2	12000	1.6	10	20/100
YT-59955	230	22.2	6500	2.2	10	25

EN Diamond blade
 PL Tarcza diamentowa
 DE Diamant-Trennscheibe
 RU Отрезной алмазный диск
 CZ Diamantový kotouč
 HU Gyémántkorong
 RO Disc cu diamant
 FR Disque diamant
 IT Disco diamantato
 ES Disco de diamante
 CN 热压X形金刚石锯片

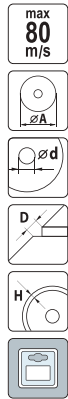

• Application: ceramic, glaze, glass, porcelain, ceramic tiles, composite hardest tiles, roof tiles
 • Przeznaczenie: płytki ceramiczne, glazura, płytki kamienne, szkło, porcelana, ceramika, gres, dachówki

YATO	ØA [mm]	Ød [mm]	max C [min ⁻¹]	D [mm]	H [mm]	
YT-59971	115	22.2	12000	1.6	10	20/120
YT-59972	125	22.2	12000	1.6	10	20/100
YT-59975	230	22.2	6500	2.0	10	25

EN Diamond blade
 PL Tarcza diamentowa
 DE Diamant-Trennscheibe
 RU Отрезной алмазный диск
 CZ Diamantový kotouč
 HU Gyémántkorong
 RO Disc cu diamant
 FR Disque diamant
 IT Disco diamantato
 ES Disco de diamante
 CN 热压超薄波纹片

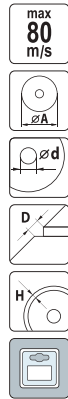

• Application: reinforced concrete, glaze, clinker, brick, limestone
 • Przeznaczenie: beton zbrojony, granit, klinkier, silikaty

YATO	ØA [mm]	Ød [mm]	max C [min ⁻¹]	D [mm]	H [mm]	
YT-59981	115	22.2	12000	1.3	10	20/200
YT-59982	125	22.2	12000	1.3	10	20/100
YT-59985	230	22.2	6500	2.0	10	25

EN Diamond blade
 PL Tarcza diamentowa
 DE Diamant-Trennscheibe
 RU Отрезной алмазный диск
 CZ Diamantový kotouč
 HU Gyémántkorong

RO Disc cu diamant
 FR Disque diamant
 IT Disco diamantato
 ES Disco de diamante
 CN 金刚石切片

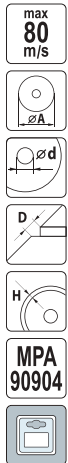

• Application: concrete, brick, calcium-silicate brick, tile, masonry, stone
 • Przeznaczenie: beton utwardzony, cegła, cegła silikatowa, granit, mur, kamień

YATO	ØA [mm]	Ød [mm]	max C [min ⁻¹]	D [mm]	H [mm]	
YT-6002	115	22.2	12000	2.1	8	20/200
YT-6003	125	22.2	11000	2.2	8	20/160
YT-6004	180	22.2	8000	2.5	8	15/60
YT-6005	230	22.2	6500	2.7	8	10/40

EN Diamond blade
 PL Tarcza diamentowa
 DE Diamant-Trennscheibe
 RU Отрезной алмазный диск
 CZ Diamantový kotouč
 HU Gyémántkorong

RO Disc cu diamant
 FR Disque diamant
 IT Disco diamantato
 ES Disco de diamante
 CN 金刚石切片

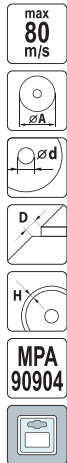

• Application: ceramic, gres, glaze, glass, porcelain
 • Przeznaczenie: płytki ceramiczne, gres, glazura, płytki kamienne, szkło, porcelana

YATO	ØA [mm]	Ød [mm]	max C [min ⁻¹]	D [mm]	H [mm]	
YT-6012	115	22.2	12000	2.1	5.3	20/200
YT-6013	125	22.2	11000	2.2	5.3	20/160
YT-6014	180	22.2	8000	2.5	5.3	15/60
YT-6015	230	22.2	6500	2.7	5.3	10/40
YT-6016	180	25.4	8000	2.2	5.3	15/60
YT-6017	200	25.4	8000	2.2	5.3	10/40

EN Diamond blade
 PL Tarcza diamentowa
 DE Diamant-Trennscheibe
 RU Отрезной алмазный диск
 CZ Diamantový kotouč
 HU Gyémántkorong

RO Disc cu diamant
 FR Disque diamant
 IT Disco diamantato
 ES Disco de diamante
 CN 金刚石切片

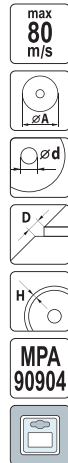

• Application: concrete, reinforced concrete, brick, tile, masonry, stone, sandstone
 • Przeznaczenie: beton utwardzony, beton zbrojony, cegła, granit, mur, kamień, piaskowiec

YATO	ØA [mm]	Ød [mm]	max C [min ⁻¹]	D [mm]	H [mm]	
YT-6022	115	22.2	12000	2.4	8	20/200
YT-6023	125	22.2	11000	2.6	8	20/160
YT-6024	180	22.2	8000	2.8	8	15/60
YT-6025	230	22.2	6500	3.1	8	10/40

EN Diamond polishing disc for stoneware
PL Tarcza diamentowa do szlifowania gresu
DE Diamant-Schleifpad für Steinzeug
RU Алмазный диск для шлифования керамогранита
CZ Kotouč leštící diamentový na keramiku
HU Gyémánt csiszoló polírozó korong
RO Disc diamentat pt. gresie
FR Disque de polissage diament pour grès
IT Disco lucidante diamentato per piastrelle
ES Disco de diamante para pulir gres
CN 金刚石软磨片

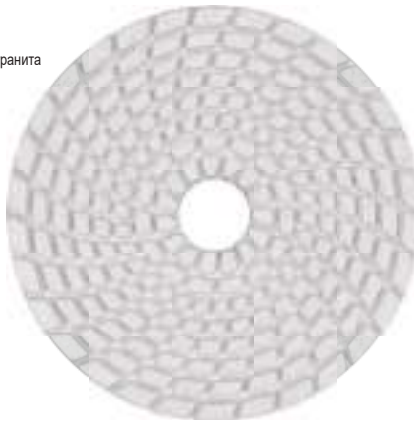

• Application: gres tile, granite, stone, concrete
• Przeznaczenie: gres, granit, kamień, beton

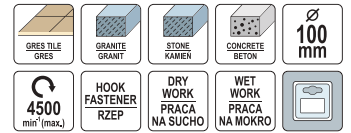

For YT-82161
Dla YT-82161

YATO	Grit / Ziarnistość	Ø [mm]	max c [min ⁻¹]	
YT-48200	D50	100	4500	50/300
YT-48201	D100	100	4500	50/300
YT-48202	D200	100	4500	50/300
YT-48203	D400	100	4500	50/300
YT-48204	D800	100	4500	50/300
YT-48205	D1500	100	4500	50/300
YT-48206	D3000	100	4500	50/300

EN Diamond grinding cup wheel
PL Tarcza szlifierska diamentowa
DE Diamant Schleiftopf Schleifteller
RU Алмазный диск шлифовальный
CZ Diamantový brusný kotoúč
HU Gyémánt csiszoló kúpos
RO Disc cupa diamentat pt. slefuit
FR Disque diamant
IT Disco diamentato
ES Disco diamante de lijar
CN 金刚石杯型磨轮



• Application: concrete, clinkier, natural stone, screed
• Przeznaczenie: beton utwardzony, klinkier, kamień naturalny, jastrych

YATO	ØA [mm]	Ød [mm]	max c [min ⁻¹]	Segment size / Rozmiar segmentu [mm]	
YT-6030	125	22.2	12200	5x7.5	20
YT-6032	125	22.2	12200	4.5x20	20

EN Diamond core bit drilling holes for sockets
PL Diamentowe wiertło koronowe
DE Diamant-Bohrkrone
RU Алмазное сверло корончатое
CZ Diamantový korunkový vrták
HU Gyémánt fúrókorona
RO Carota diamentata pt. beton
FR Trépiéd à mur diamentées
IT Corona diamentata per calcestruzzo
ES Broca corona de diamante
CN 金刚石薄壁钻

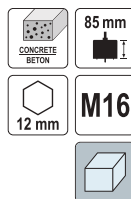

• Application: concrete, calcium-silicate brick, porous ceramics
• Przeznaczenie: beton utwardzony, cegła silikatowa, ceramika poryzowana

YATO	Ø [mm]	max c [min ⁻¹]	Segment size / Rozmiar segmentu [mm]	
YT-6045	65	1030	3.5x10x24	24
YT-6046	82	850	3.5x10x24	20

EN Diamond grinding cup wheel
PL Tarcza szlifierska diamentowa
DE Diamant Schleiftopf Schleifteller
RU Алмазный диск шлифовальный
CZ Diamantový brusný kotoúč
HU Gyémánt csiszoló kúpos
RO Disc cupa diamentat pt. slefuit
FR Disque diamant
IT Disco diamentato
ES Disco diamante de lijar
CN 金刚石磨轮



• Application: concrete, screed
• Przeznaczenie: beton, jastrych

YATO	ØA [mm]	Ød [mm]	max c [min ⁻¹]	Segment size / Rozmiar segmentu [mm]	For / Dla	
YT-60322	125	22.2	12200	5x9	YT-82110, YT-82101	30
YT-60323	180	22.2	6600	5x9	YT-82341, YT-82110	10

EN Diamond core bit drilling holes for sockets
PL Diamentowe wiertło koronowe
DE Diamant-Bohrkrone
RU Алмазное сверло корончатое
CZ Diamantový korunkový vrták
HU Gyémánt fúrókorona
RO Carota diamentata pt. beton
FR Trépiéd à mur diamentées
IT Corona diamentata per calcestruzzo
ES Broca corona de diamante
CN 激光薄壁钻



For YT-81980
Dla YT-81980



YATO	Ø [mm]	Segment size / Rozmiar segmentu [mm]	
YT-60371	32	4x8x20	10
YT-60372	42	4x8x20	10
YT-60373	52	4x8x24	10
YT-60374	68	4x8x24	8
YT-60375	82	4x8x24	4
YT-60376	102	4x8x24	4
YT-60377	122	4x8x24	4
YT-60378	152	4x8x24	2
YT-60379	182	4x8x24	2



- EN TCT circular saw blade for wood
- PL Pila tarczowa do drewna z węglikiem wolframu
- DE Kreissägeblatt HM-Bestückt
- RU Диск пильный с карбидом вольфрама
- CZ Kotoučová pila na dřevo z karbidem wolframu
- HU Wolframkarbidos körfűrész fához
- RO Ferăstrău circular cu dinți din wolfram pt. lemn
- FR Lame de scie circulaire carburée
- IT Lama troncatrice taglio legno
- ES Disco de sierra con carbono de tungsteno
- CN 木工圆锯片



• Application: for cutting wood and plastics



• Przeznaczenie: do cięcia drewna, płyt drewnopochodnych, tworzyw sztucznych

YATO 	Ø [mm]	Ød [mm]	max C [min ⁻¹]	D [mm]	s [mm]	T	For / Dla	
YT-6050	130	16.0	10000	2.8	2.0	24	-	25/50
YT-6052	140	20.0	10000	2.8	2.0	16	-	25/50
YT-60522	140	20.0	11000	2.8	2.0	30	-	25/50
YT-6053	140	16.0	10000	2.8	2.0	30	-	25/50
YT-60533	150	20.0	10000	2.8	2.0	30	-	25/50
YT-6055	160	20.0	9500	2.8	2.0	18	79254	25/50
YT-6056	160	30.0	9500	2.8	2.0	24	79254	25/50
YT-6057	160	30.0	9500	2.8	2.0	36	-	25/50
YT-60577	160	20.0	9500	2.2	1.5	36	79254	25/50
YT-6058	160	20.0	9500	2.8	2.0	48	79254	25/50
YT-60581	160	20.0	9500	2.2	1.5	60	-	25/50
YT-60590	165	16.0	9500	2.2	1.5	24	YT-82810, YT-82811	25/50
YT-60591	165	16.0	9500	2.2	1.5	36	YT-82810, YT-82811	25/50
YT-60582	170	16.0	9500	3.2	2.2	12	-	25/50
YT-60583	170	16.0	9500	3.2	2.2	40	-	25/50
YT-6060	184	30.0	9000	3.2	2.2	24	YT-82172	25/50
YT-6061	184	30.0	9000	3.2	2.2	40	YT-82172	25/50
YT-6062	184	30.0	9000	3.2	2.2	50	YT-82172	25/50
YT-6063	185	20.0	9000	2.4	1.4	18	YT-82151	10/20
YT-60621	185	20.0	9000	2.2	1.5	24	YT-82151	25/50
YT-60622	185	20.0	9000	2.2	1.5	36	YT-82151	25/50
YT-60633	190	16.0	8500	3.2	2.2	40	YT-82150	10/20
YT-60634	190	20.0	8500	2.2	1.5	24	YT-82150	10/20
YT-60635	190	20.0	8500	2.2	1.5	36	YT-82150	10/20
YT-60636	190	20.0	8500	2.2	1.5	60	-	10/20
YT-60488	190	30.0	8500	3.2	2.2	20	-	10/20
YT-60489	190	30.0	8500	3.2	2.2	40	-	10/20
YT-6065	200	30.0	8000	3.2	2.2	24	-	10/20
YT-60652	200	30.0	8000	3.2	2.2	40	-	10/20
YT-6066	205	18.0	6000	3.2	2.0	24	-	10/20
YT-60665	210	30.0	7500	3.2	2.2	20	-	10/20

YATO 	Ø [mm]	Ød [mm]	max C [min ⁻¹]	D [mm]	s [mm]	T	For / Dla	
YT-6067	210	30.0	8000	3.2	2.2	40	-	10/20
YT-6068	210	30.0	8000	3.2	2.2	60	-	10/20
YT-60682	216	30.0	7500	3.2	2.2	48	-	10/20
YT-60685	235	25.4	7000	2.8	1.8	24	YT-82153	10/20
YT-60686	235	25.4	7000	2.8	1.8	36	YT-82153	10/20
YT-60687	235	25.4	7000	2.8	1.8	60	YT-82153	10/20
YT-6070	250	30.0	6000	3.2	2.2	24	YT-82165	10/20
YT-6071	250	30.0	6000	3.2	2.2	40	YT-82165	10/20
YT-6072	250	30.0	6000	3.2	2.2	60	YT-82165	10/20
YT-60731	255	30.0	6000	30.0	2.0	24	YT-82171, YT-82173, YT-82165	10/20
YT-60732	255	30.0	6000	3.0	2.0	36	YT-82173	10/20
YT-60733	255	30.0	6000	3.0	2.0	60	YT-82173	10/20
YT-6075	300	30.0	6000	3.2	2.2	24	YT-82175	10
YT-6076	300	30.0	5000	3.2	2.2	40	YT-82175	10
YT-6077	300	30.0	5000	3.2	2.2	60	YT-82175	10
YT-6078	300	30.0	5000	3.2	2.2	96	YT-82175	10
YT-60782	305	30.0	5000	3.2	2.2	24	YT-82175	10
YT-60783	305	30.0	5000	3.2	2.2	40	YT-82175	10
YT-60784	305	30.0	5000	3.2	2.2	60	YT-82175	10
YT-60785	305	30.0	5000	3.2	2.2	96	YT-82175	10
YT-60791	315	30.0	4900	3.2	2.2	40	-	10
YT-60792	315	30.0	4500	3.5	2.5	48	-	10
YT-60794	315	30.0	4500	3.5	2.5	80	-	10
YT-60795	315	30.0	4900	3.2	2.2	96	-	10
YT-6080	350	30.0	4500	3.5	2.5	28	-	10
YT-6081	350	30.0	4500	3.5	2.5	40	-	10
YT-6082	350	30.0	4500	3.5	2.5	54	-	10
YT-6083	350	30.0	4500	3.5	2.5	84	-	10
YT-6085	400	30.0	4000	3.8	2.8	32	-	10
YT-6086	400	30.0	4000	3.8	2.8	60	-	10

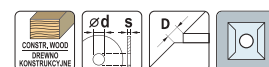
- EN Circular saw blade for wood
- PL Pila tarczowa do drewna
- DE Kreissägeblatt
- RU Диск пильный по дереву
- CZ Kotoučová pila na dřevo
- HU Körfűrész fához
- RO Ferăstrău circular pt. lemn
- FR Lame de scie pour bois
- IT Lama taglio legno
- ES Disco de sierra
- CN 木工尖齿片



YATO 	Ø [mm]	Ød [mm]	max C [min ⁻¹]	D [mm]	s [mm]	T	
YT-60871	500	32	3000	4.5	2.9	60	4
YT-60872	500	32	3000	4.5	2.9	80	4

EN TCT circular saw blade for structural wood
 PL Pila tarczowa z węglikiem wolframu do cięcia drewna konstrukcyjnego
 DE Kreissägeblatt HM-Bestückt von Holzkonstruktionen
 RU Диск пильный твердого сплава для резы строительной конструкционной древесины
 CZ Kotoučová pila s karbidem wolframu k řezání konstrukčního dřeva
 HU Wolfram-karbid szegmens fűrészárca szerkezeti fához
 RO Ferăstrău circular cu dinți din wolfram pt. tăierea lemnului pt. construcții
 FR Lame de scie circulaire carbure pour construction bois
 IT Lama al tungsteno da legno
 ES Disco de sierra con carbono de tungsteno para corte de madera estructural
 CN 木工圆锯片

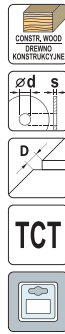

YATO	Ø [mm]	Ød [mm]	max. c [min ⁻¹]	D [mm]	s [mm]	T	
YT-60480	160	20	9500	2.2	1.5	24	25/50
YT-60482	180	20	9000	2.4	1.8	36	20/40
YT-60484	250	30	6000	2.4	1.8	48	10/20

EN TCT circular saw blade for structural wood
 PL Pila tarczowa z węglikiem wolframu do cięcia drewna konstrukcyjnego
 DE Kreissägeblatt HM-Bestückt von Holzkonstruktionen
 RU Диск пильный твердого сплава для резы строительной конструкционной древесины
 CZ Kotoučová pila s karbidem wolframu k řezání konstrukčního dřeva
 HU Wolfram-karbid szegmens fűrészárca szerkezeti fához
 RO Ferăstrău circular cu dinți din wolfram pt. tăierea lemnului pt. construcții
 FR Lame de scie circulaire carbure pour construction bois
 IT Lama al tungsteno da legno
 ES Disco de sierra con carbono de tungsteno para corte de madera estructural
 CN 锯钉片

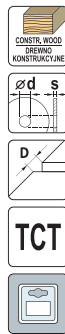

YATO	Ø [mm]	Ød [mm]	max. c [min ⁻¹]	D [mm]	s [mm]	T	
YT-60628	185	20	9000	2.4	1.8	14	25/50

EN PVC cutting blade
 PL Pila tarczowa do cięcia PVC
 DE PVC-Trennscheibe
 RU Резущий диск ПВХ
 CZ PVC řezný disk
 HU Körfűrészárca
 RO Panza de ferastrău circular PVC
 FR Disque de coupe en PVC
 IT Disco da taglio per PVC
 ES Sierra circular CMT para corte PVC
 CN 锯塑片



EN TCT circular saw blade for aluminium
 PL Pila tarczowa do aluminium z węglikiem wolframu
 DE Hartmetallbestückt Kreissägeblatt für Aluminium
 RU Диск пильный по алюминию
 CZ Kotoučová pila na hliník s karbidem wolframu
 HU Wolframkarbidos körfűrészlap, alumíniumhoz
 RO Disc circular pt. aluminiu
 FR Lame de scie circulaire pour aluminium
 IT Lama tronatrice alluminio
 ES Disco de sierra con carbono
 CN 圆锯片

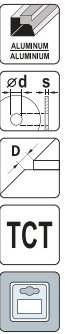

• Application: for cutting aluminium profiles, laminates, plexi, corian and other plastics
 • Negative angle of teeth
 • Przeznaczenie: do cięcia profili aluminiowych, laminatów, pleksi, korianu, tworzyw sztucznych
 • Negatywny kąt natarcia zębów

YATO	Ø [mm]	Ød [mm]	max. c [min ⁻¹]	D [mm]	s [mm]	T	
YT-60905	160	20	9500	2.2	1.5	52	25/50
YT-60907	180	20	9000	2.2	1.5	60	20/40
YT-6091	200	30	8000	3.0	2.2	60	10/20
YT-6093	210	30	8000	3.0	2.2	72	10/20
YT-6095	250	30	6000	3.0	2.2	100	10/20
YT-6097	300	30	5000	3.0	2.2	100	10
YT-6099	350	30	4500	3.2	2.5	100	10

EN Blade for cutting laminate and plywood
 PL Pila tarczowa do cięcia paneli i płyt meblowych
 DE Kreissägeplatte für Laminatböden
 RU Ламинированный режущий диск
 CZ Laminátový řezací kotouč
 HU Körfűrészlap
 RO Disc de tăiere laminat
 FR Disque de coupe en stratifié
 IT Disco da taglio per pannelli e pannelli per mobili
 ES Disco de corte laminado
 CN 普通木工片

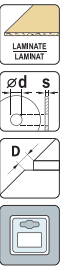

YATO	Ø [mm]	Ød [mm]	max. c [min ⁻¹]	D [mm]	s [mm]	T	
YT-60631	185	20	9000	1.7	1.4	140	25/50

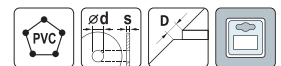

YATO	Ø [mm]	Ød [mm]	max. c [min ⁻¹]	D [mm]	s [mm]	T	
YT-60627	185	20	9000	2.5	1.5	60	25/50

EN Metal cutting disc
 PL Tarcza do cięcia metalu
 DE Trennscheibe für Metall
 RU Диск отрезной по металлу
 CZ Kotouč pro řezání kovu
 HU Vágókorong fémhez
 RO Disc debitat metal
 FR Disque à tronçonner pour métal
 IT Disco per taglio metallo
 ES Disco cortador para metal
 CN 金属切割片



INOX

max 80 m/s

YATO	ØA [mm]	Ød [mm]	D [mm]	max C [min ⁻¹]	pcs / szt.	
YT-6101	115	22	1.2	13200	5	25/200
YT-61025	125	22.23	1.0	12200	5	50/400
YT-6103	125	22	1.2	12200	5	25/200
YT-6104	125	22	2.5	12200	5	25/200
YT-6105	180	22	1.5	8600	5	25/50
YT-6107	230	22	2.0	6500	5	25/50

EN Metal cutting disc
 PL Tarcza do cięcia metalu
 DE Trennscheibe für Metall
 RU Диск отрезной по металлу
 CZ Kotouč pro řezání kovu
 HU Vágókorong fémhez
 RO Disc debitat metal
 FR Disque à tronçonner pour métal
 IT Disco per taglio metallo
 ES Disco cortador para metal
 CN 金属切割片



max 80 m/s

For YT-82180
 Dla YT-82180

YATO	ØA [mm]	Ød [mm]	D [mm]	max C [min ⁻¹]	pcs / szt.
YT-61132	355	25.4	3.2	4400	25

EN Metal grinding disc
 PL Tarcza do szlifowania metalu
 DE Metall-Schleif-scheibe
 RU Круги для шлифования по металлу
 CZ Kotouč pro broušení kovu
 HU Vágókorong fémhez
 RO Disc pt. slefuit metal
 FR Disque de polissage pour métaux
 IT Disco per rettifica metallo
 ES Disco cortador para metal
 CN 金属磨片



max 80 m/s

• Depressed center
 • Wypukła

YATO	ØA [mm]	Ød [mm]	D [mm]	max C [min ⁻¹]	pcs / szt.	
YT-6121	115	22	6.0	13200	5	25/100
YT-6124	125	22	6.0	12200	5	30/120
YT-6126	125	22	8.0	12200	5	25/100
YT-6125	230	22	6.0	6500	5	5/30

EN Metal cutting disc
 PL Tarcza do cięcia metalu
 DE Trennscheibe für Metall
 RU Диск отрезной по металлу
 CZ Kotouč pro řezání kovu
 HU Vágókorong fémhez
 RO Disc debitat metal
 FR Disque à tronçonner pour métal
 IT Disco per taglio metallo
 ES Disco cortador para metal
 CN 金属切割片



max 80 m/s

YATO	ØA [mm]	Ød [mm]	D [mm]	max C [min ⁻¹]	pcs / szt.	
YT-5920	115	22	1.2	13200	5	25/200
YT-5923	125	22	1.2	12200	5	25/200
YT-5924	125	22	2.5	12200	5	25/200
YT-6110	125	22	3.2	12200	5	25/200
YT-5925	180	22	1.5	8600	5	25/50
YT-5927	230	22	2.0	6500	5	25/50
YT-6112	230	22	3.2	6500	5	25/50
YT-6113	300	32	3.2	5100	5	25
YT-6136	350	32	3.5	4400	5	25
YT-6137	400	32	4.0	3800	5	25

EN Metal cutting disc
 PL Tarcza do cięcia metalu
 DE Trennscheibe für Metall
 RU Диск отрезной по металлу
 CZ Kotouč pro řezání kovu
 HU Vágókorong fémhez
 RO Disc debitat metal
 FR Disque à tronçonner pour métal
 IT Disco per taglio metallo
 ES Disco cortador para metal
 CN 金属切割片



max 80 m/s

• Depressed center
 • Wypukła

YATO	ØA [mm]	Ød [mm]	D [mm]	max C [min ⁻¹]	pcs / szt.	
YT-6116	125	22	2.5	12200	5	25/200
YT-6120	230	22	3.2	6500	5	25/50

EN Metal grinding disc
 PL Tarcza do szlifowania metalu
 DE Metall-Schleif-scheibe
 RU Круги для шлифования по металлу
 CZ Kotouč pro broušení kovu
 HU Vágókorong fémhez
 RO Disc pt. slefuit metal
 FR Disque de polissage pour métaux
 IT Disco per rettifica metallo
 ES Disco cortador para metal
 CN 树脂切片



INOX

max 80 m/s

• Depressed center
 • Wypukła

YATO	ØA [mm]	Ød [mm]	D [mm]	max C [min ⁻¹]	pcs / szt.	
YT-5947	125	22	6.8	12200	5	25/100

EN Stone cutting disc
PL Tarcza do cięcia kamienia
DE Stein-Trennscheibe
RU Диск отрезной по камню
CZ Kotouč pro řezání kamene
HU Vágókorong kőhöz
RO Disc pt. tăiat piatră
FR Disque de coupe pour granit
IT Disco per taglio pietra
ES Disco cortador de piedra
CN 树脂切片



EN Stone grinding disc
PL Tarcza do szlifowania kamienia
DE Stein-Schleifscheibe
RU Диск для шлифования по камню
CZ Kotouč pro broušení kamene
HU Csiszolókorong kőhöz
RO Disc pt. șlefuit piatră
FR Disque de polissage pour granit
IT Disco per rettifica pietra
ES Disco cortador de piedra
CN 树脂切片



• Depressed center

• Wypukła

YATO	ØA [mm]	Ød [mm]	max C [min ⁻¹]	D [mm]	pcs / szt.	
YT-5930	115	22	13200	1.5	5	25/200
YT-5932	125	22	12200	1.5	5	25/200
YT-5933	125	22	12200	3.2	5	25/200
YT-5935	230	22	6500	3.2	5	25/50

YATO	ØA [mm]	Ød [mm]	D [mm]	max C [min ⁻¹]	pcs / szt.	
YT-6132	115	22	6.0	13200	5	25/100
YT-6133	125	22	6.8	12200	5	25/100

EN Universal grinding disc
PL Tarcza szlifierska uniwersalna
DE Universelle Schleifscheibe
RU Диск шлифовальный универсальный
CZ Brusný kotouč univerzální
HU Univerzális csiszolókorong
RO Disc de rectificat
FR Disque de ponçage universel
IT Disco di molatura
ES Muela abrasiva universal
CN 磨基砂盘



EN Rubber disc for angle grinder
PL Przystawka do szlifierek kątowych
DE Klett-Gummihaftstützeller mit Gewindeflansch
RU Диск резиновый с липучкой для шлифмашины
CZ Euro disk do úhelníků ze zipem
HU Csiszolókorong kőhöz
RO Suport disc pt. polizor unghiular
FR Disque caoutchouc avec velcro
IT Disco con velcro e accessori
ES Disco de goma para angul con velcro
CN 抛光盘



YATO	Grit / Ziarnistość	ØA [mm]	Ød [mm]	max C [min ⁻¹]	
YT-83260	P8	125	22.2	17000	100
YT-83261	P16	125	22.2	17000	100
YT-83262	P24	125	22.2	17000	100
YT-83263	P36	125	22.2	17000	100
YT-83264	P60	125	22.2	17000	100
YT-83265	P80	125	22.2	17000	100
YT-83266	P120	125	22.2	17000	100

YATO	Ø [mm]	max C [min ⁻¹]	
YT-4770	230	6600	25

EN Tapered rasp disc
PL Tarnik skośny
DE Raspelscheibe schräge Oberfläche
RU Диск фреза универсальный по дереву для УШМ
CZ Rotační rašple
HU Rotációs rászpoly
RO Disc raspel
FR Disque râpe
IT Disco raspa obliquo
ES Disco escofina
CN 圆锥锉刀盘



EN Tapered rasp disc
PL Tarnik skośny
DE Raspelscheibe schräge Oberfläche
RU Диск фреза универсальный по дереву для УШМ
CZ Rotační rašple
HU Rotációs rászpoly
RO Disc raspel
FR Disque râpe
IT Disco raspa obliquo
ES Disco escofina
CN 圆锥锉刀盘



• Grinding, milling
• Wood, cellular concrete, plastics, gypsum, drywall
• Szlifowanie, frezowanie
• Drewno, beton komórkowy, tworzywa sztuczne, gips, płyty gipsowo-kartonowe

YATO	Ø [mm]	Ød [mm]	max C [min ⁻¹]	[#]	
YT-59164	115	22.2	13000	2	10
YT-59165	125	22.2	13000	2	10

• Grinding, milling
• Wood, cellular concrete, plastics, gypsum, drywall
• Szlifowanie, frezowanie
• Drewno, beton komórkowy, tworzywa sztuczne, gips, płyty gipsowo-kartonowe

YATO	Ø [mm]	Ød [mm]	max C [min ⁻¹]	[#]	
YT-59166	115	22.2	13000	1	10
YT-59167	125	22.2	13000	1	10

EN Carving rasp disc
 PL Tarnik promieniowy
 DE Rundraspelfräscheibe
 RU Диск-фреза закругленный для УШМ
 CZ Rašple rotační oblá
 HU Ívelt ráspolykorong
 RO Disc raspe pt. sculptat
 FR Disque de sculpture
 IT Disco a raspa stondato
 ES Disco escofina curvo para tallado
 CN 雕刻锉刀盘



WOOD DREWNIO
 AERATED CONCRETE BETON KOMÓRKOWY
 PLASTICS PVC PLASTIK PVC
 DRYWALL PLYTA GK
 STYROFOAM STYROPIAN
 RUBBER GUMA

#1
 #2 MILLING FREZOWANIE
 GRINDING SZLIFOWANIE

- Grinding, milling
- Wood, cellular concrete, plastics, gypsum, drywall
- Szlifowanie, frezowanie
- Drewno, beton komórkowy, tworzywa sztuczne, gips, płyty gipsowo-kartonowe

YATO	Ø [mm]	Ød [mm]	H [mm]	max C [min ⁻¹]	[#]	
YT-59155	120	22.2	13	13000	1	10
YT-59156	120	22.2	13	13000	2	10

EN Tapered rasp disc
 PL Tarnik wypukły
 DE Raspelscheibe gekröpft
 RU Диск фреза универсальный по дереву для УШМ
 CZ Rotační rašple
 HU Rotációs ráspoly
 RO Disc raspe
 FR Disque râpe
 IT Disco raspa convesso
 ES Disco escofina
 CN 锯片



WOOD DREWNIO
 AERATED CONCRETE BETON KOMÓRKOWY
 PLASTICS PVC PLASTIK PVC
 DRYWALL PLYTA GK
 STYROFOAM STYROPIAN
 RUBBER GUMA

#1
 #2
 #3

- Grinding, milling
- Wood, cellular concrete, plastics, gypsum, drywall
- Szlifowanie, frezowanie
- Drewno, beton komórkowy, tworzywa sztuczne, gips, płyty gipsowo-kartonowe

YATO	Ø [mm]	Ød [mm]	H [mm]	max C [min ⁻¹]	[#]	
YT-59168	125	22.2	13000	1	10	
YT-59169	125	22.2	13000	2	10	
YT-59170	125	22.2	13000	3	10	

EN Milling rasp disc
 PL Frez tarnikowy
 DE Raspelfräscheibe
 RU Диск-фреза шлифовальный для УШМ
 CZ Rotační rašple frézovací
 HU Ráspolykorong
 RO Disc raspe pt. frezat
 FR Disque à râpe de fraisage
 IT Disco a raspa
 ES Disco escofina
 CN 铣刀盘



WOOD DREWNIO
 AERATED CONCRETE BETON KOMÓRKOWY
 PLASTICS PVC PLASTIK PVC
 DRYWALL PLYTA GK
 STYROFOAM STYROPIAN
 RUBBER GUMA

#1
 MILLING FREZOWANIE
 GRINDING SZLIFOWANIE
 GROOVING BRUZDOWANIE

- Milling, grinding
- Wood, cellular concrete, plastics, gypsum, drywall
- Frezowanie, bruzdowanie
- Drewno, beton komórkowy, tworzywa sztuczne, gips, płyty gipsowo-kartonowe

YATO	Ø [mm]	Ød [mm]	+/- [mm]	max C [min ⁻¹]	[#]	
YT-59175	90	22.2	21	13000	10	
YT-59176	118	22.2	21	13000	10	

EN Milling rasp disc
 PL Frez tarnikowy
 DE Raspelfräscheibe
 RU Диск-фреза шлифовальный для УШМ
 CZ Rotační rašple frézovací
 HU Ráspolykorong
 RO Disc raspe pt. frezat
 FR Disque à râpe de fraisage
 IT Disco a raspa
 ES Disco escofina
 CN 铣刀盘



WOOD DREWNIO
 AERATED CONCRETE BETON KOMÓRKOWY
 PLASTICS PVC PLASTIK PVC
 DRYWALL PLYTA GK
 STYROFOAM STYROPIAN
 RUBBER GUMA

#1
 MILLING FREZOWANIE
 GRINDING SZLIFOWANIE
 GROOVING BRUZDOWANIE

- Milling, grinding, grooving
- Wood, cellular concrete, plastics, gypsum, drywall
- Frezowanie, szlifowanie, bruzdowanie
- Drewno, beton komórkowy, tworzywa sztuczne, gips, płyty gipsowo-kartonowe

YATO	Ø [mm]	Ød [mm]	H [mm]	max C [min ⁻¹]	[#]	
YT-59178	120	22.2	6	13000	1	10
YT-59179	120	22.2	12	13000	1	10

EN Rasp milling cutter
 PL Frez tarnikowy uniwersalny
 DE Raspelfräscheibe
 RU Универсальная фреза
 CZ Rotační rašple
 HU Rotációs ráspoly
 RO Disc raspe
 FR Fraise râpe
 IT Fresa raspa a disco universale
 ES Disco escofina
 CN 锯片



WOOD DREWNIO
 AERATED CONCRETE BETON KOMÓRKOWY
 PLASTICS PVC PLASTIK PVC
 DRYWALL PLYTA GK
 STYROFOAM STYROPIAN
 RUBBER GUMA

#1

- Milling, grinding, grooving
- Wood, cellular concrete, plastics, gypsum, drywall
- Frezowanie, szlifowanie, bruzdowanie
- Drewno, beton komórkowy, tworzywa sztuczne, gips, płyty gipsowo-kartonowe

YATO	Ø [mm]	Ød [mm]	+/- [mm]	max C [min ⁻¹]	[#]	
YT-59177	118	22.2	21	13000	1	10

EN Depressed center milling rasp disc
 PL Frez tarnikowy pełny wypukły
 DE Raspelfräscheibe konvexe
 RU Диск-фреза выпуклый для УШМ
 CZ Rotační rašple frézovací vypouklá
 HU Rotációs ráspolykorong széles
 RO Disc depresat raspe pt. frezat
 FR Disque à râpe de fraisage arrondi
 IT Disco a raspa a centro depresso
 ES Disco escofina con centro deprimido
 CN 凹陷式中心铣盘



WOOD DREWNIO
 AERATED CONCRETE BETON KOMÓRKOWY
 PLASTICS PVC PLASTIK PVC
 DRYWALL PLYTA GK
 STYROFOAM STYROPIAN
 RUBBER GUMA

#1
 #2 MILLING FREZOWANIE
 GRINDING SZLIFOWANIE
 GROOVING BRUZDOWANIE

- Milling, grinding, grooving
- Wood, cellular concrete, plastics, gypsum, drywall
- Frezowanie, szlifowanie, bruzdowanie
- Drewno, beton komórkowy, tworzywa sztuczne, gips, płyty gipsowo-kartonowe

YATO	Ø [mm]	Ød [mm]	H [mm]	max C [min ⁻¹]	[#]	
YT-59180	120	22.2	6	13000	1	10
YT-59181	120	22.2	6	13000	2	10
YT-59182	120	22.2	12	13000	1	10
YT-59183	120	22.2	12	13000	2	10
YT-59184	120	22.2	18	13000	1	10
YT-59185	120	22.2	18	13000	2	10

10

EN Tin snips
PL Nożyce do cięcia blachy
DE Blechscherer
RU Ножницы по металлу

CZ Nůžky na plech
HU Lemezvágó olló
RO Foarfece pt. tablă
FR Cisaille à tôle

IT Cesiole per lamiera
ES Tijeras para chapas
CN 航空剪



CrMo

INCREASED CUTTING POWER
ZWIĘKSZONA SIŁA CIĘCIA



DIN 6438 HRC 60-62



DIN 6438 HRC 60-62

YATO	L [mm]	Cutting length / Długość cięcia [mm]	Cooper / Miedź [mm]	Cold rolled steel / Stal zimnowalcowana [mm]	Steel HRC35 / Stal HRC35 [mm]	SS 304 / Stal nierdzewna 304 [mm]	
YT-1910	260	35	1.8	1.5	1.0	0.9	6/36

YATO	L [mm]	Cutting length / Długość cięcia [mm]	Cooper / Miedź [mm]	Cold rolled steel / Stal zimnowalcowana [mm]	Steel HRC35 / Stal HRC35 [mm]	SS 304 / Stal nierdzewna 304 [mm]	
YT-1915	235	30	1.5	1.2	1.0	0.7	6/36



DIN 6438 HRC 60-62



250 mm HRC 56-62

HIGH FREQUENCY
HARDENING
HARTOWANIE
IMPULSOWE

SERRATED
EDGES
ZĄBKOWANE
KRAWĘDZIE

YATO	L [mm]	Cutting length / Długość cięcia [mm]	Cooper / Miedź [mm]	Cold rolled steel / Stal zimnowalcowana [mm]	Steel HRC35 / Stal HRC35 [mm]	SS 304 / Stal nierdzewna 304 [mm]	
YT-1918	260	32	1.8	1.5	1.0	0.9	6/36

YATO	L [mm]	Cutting length / Długość cięcia [mm]	Cooper / Miedź [mm]	Cold rolled steel / Stal zimnowalcowana [mm]	Steel HRC35 / Stal HRC35 [mm]	SS 304 / Stal nierdzewna 304 [mm]	
YT-1960	250	40	2.0	1.5	1.0	0.8	6/36

EN Tin snips
PL Nożyce do cięcia blachy
DE Blechscherer

RU Ножницы по металлу
CZ Nůžky na plech
HU Lemezvágó olló

RO Foarfece pt. tablă
FR Cisaille à tôle
IT Cesiole per lamiera

ES Tijeras para chapas
CN 台式航空剪



90°

HRC 60-62

CrMo

SERRATED
EDGES
ZĄBKOWANE
KRAWĘDZIE



YATO	L [mm]	Cutting length / Długość cięcia [mm]	Cooper / Miedź [mm]	Cold rolled steel / Stal zimnowalcowana [mm]	Steel HRC35 / Stal HRC35 [mm]	SS 304 / Stal nierdzewna 304 [mm]	
YT-1913	225	30	0.78	0.53	0.46	0.36	6/36

EN Tin snips
PL Nożyce do cięcia blachy
DE Blechscherer
RU Ножницы по металлу

CZ Nůžky na plech
HU Lemezvágó olló
FR Cisaille à tôle

IT Cesiole per lamiera
ES Tijeras para chapas
CN 航空剪



CrMo

INCREASED CUTTING POWER
ZWIĘKSZONA SIŁA CIĘCIA



DIN 6438 HRC 60-62

YATO	L [mm]	Cutting length / Długość cięcia [mm]	Cooper / Miedź [mm]	Cold rolled steel / Stal zimnowalcowana [mm]	Steel HRC35 / Stal HRC35 [mm]	SS 304 / Stal nierdzewna 304 [mm]	
YT-1912	260	35	1.8	1.5	1.0	0.9	6/36



DIN 6438 HRC 60-62



250 mm HRC 56-62

SERRATED
EDGES
ZĄBKOWANE
KRAWĘDZIE

HIGH FREQUENCY
HARDENING
HARTOWANIE
IMPULSOWE

YATO	L [mm]	Cutting length / Długość cięcia [mm]	Cooper / Miedź [mm]	Cold rolled steel / Stal zimnowalcowana [mm]	Steel HRC35 / Stal HRC35 [mm]	SS 304 / Stal nierdzewna 304 [mm]	
YT-1922	290	75	1.1	0.94	0.7	0.53	6/36

YATO	L [mm]	Cutting length / Długość cięcia [mm]	Cooper / Miedź [mm]	Cold rolled steel / Stal zimnowalcowana [mm]	Steel HRC35 / Stal HRC35 [mm]	SS 304 / Stal nierdzewna 304 [mm]	
YT-1962	250	45	2.0	1.5	1.0	0.8	6/36

EN Tin snips
 PL Nożyce do cięcia blachy
 DE Blechscherer
 RU Ножницы по металлу

CZ Nůžky na plech
 HU Lemezvágó olló
 RO Foarfece pt. tablă
 FR Cisaille à tôle

IT Cesoiè per lamiere
 ES Tijeras para chapas
 CN 航空剪



DIN 6438 **HRC 60-62**

YATO	L [mm]	Cutting length / Długość cięcia [mm]	Cooper / Miedź [mm]	Cold rolled steel / Stal zimnowalcowana [mm]	Steel HRC35 / Stal HRC35 [mm]	SS 304 / Stal nierdzwena 304 [mm]	
YT-1911	260	35	1.8	1.5	1.0	0.9	6/36

DIN 6438 **HRC 60-62**

YATO	L [mm]	Cutting length / Długość cięcia [mm]	Cooper / Miedź [mm]	Cold rolled steel / Stal zimnowalcowana [mm]	Steel HRC35 / Stal HRC35 [mm]	SS 304 / Stal nierdzwena 304 [mm]	
YT-1916	235	30	1.5	1.2	1.0	0.7	6/36



DIN 6438 **HRC 60-62**

YATO	L [mm]	Cutting length / Długość cięcia [mm]	Cooper / Miedź [mm]	Cold rolled steel / Stal zimnowalcowana [mm]	Steel HRC35 / Stal HRC35 [mm]	SS 304 / Stal nierdzwena 304 [mm]	
YT-1919	260	32	1.8	1.5	1.0	0.9	6/36

250 mm **HRC 56-62**

SERRATED EDGES / ZABKOWANE KRAWĘDZIE
 HIGH FREQUENCY HARDENING / HARTOWANIE WYŚWIŁCONE

YATO	L [mm]	Cutting length / Długość cięcia [mm]	Cooper / Miedź [mm]	Cold rolled steel / Stal zimnowalcowana [mm]	Steel HRC35 / Stal HRC35 [mm]	SS 304 / Stal nierdzwena 304 [mm]	
YT-1961	250	40	2.0	1.5	1.0	0.8	6/36

10

EN Tin snips
 PL Nożyce do cięcia blachy
 DE Blechscherer
 RU Ножницы по металлу
 CN 台式航空剪

CZ Nůžky na plech
 HU Lemezvágó olló
 RO Foarfece pt. tablă
 FR Cisaille à tôle

IT Cesoiè per lamiere
 ES Tijeras para chapas
 CN 台式航空剪



YATO	L [mm]	Cutting length / Długość cięcia [mm]	Cooper / Miedź [mm]	Cold rolled steel / Stal zimnowalcowana [mm]	Steel HRC35 / Stal HRC35 [mm]	SS 304 / Stal nierdzwena 304 [mm]	
YT-1914	225	30	0.78	0.53	0.46	0.36	6/36

EN Tin snips
 PL Nożyce do cięcia blachy
 DE Blechscherer
 RU Ножницы по металлу
 CZ Nůžky na plech
 HU Lemezvágó olló

RO Foarfece pt. tablă
 FR Cisaille à tôle

IT Cesoiè per lamiere
 ES Tijeras para chapas
 CN 航空剪



YATO	L [mm]	Cutting length / Długość cięcia [mm]	Cooper / Miedź [mm]	Cold rolled steel / Stal zimnowalcowana [mm]	Steel HRC35 / Stal HRC35 [mm]	SS 304 / Stal nierdzwena 304 [mm]	
YT-1900	260	30	0.94	0.78	0.6	0.45	6/24

EN Tin snips
 PL Nożyce do cięcia blachy
 DE Blechscherer
 RU Ножницы по металлу

CZ Nůžky na plech
 HU Lemezvágó olló
 RO Foarfece pt. tablă
 FR Cisaille à tôle

IT Cesoiè per lamiere
 ES Tijeras para chapas
 CN 航空剪



YATO	L [mm]	Cutting length / Długość cięcia [mm]	Cooper / Miedź [mm]	Cold rolled steel / Stal zimnowalcowana [mm]	Steel HRC35 / Stal HRC35 [mm]	SS 304 / Stal nierdzwena 304 [mm]	
YT-1901	260	30	0.94	0.78	0.6	0.45	6/24

YATO	L [mm]	Cutting length / Długość cięcia [mm]	Cooper / Miedź [mm]	Cold rolled steel / Stal zimnowalcowana [mm]	Steel HRC35 / Stal HRC35 [mm]	SS 304 / Stal nierdzwena 304 [mm]	
YT-1902	300	50	0.94	0.78	0.6	0.45	6/24

EN Tin snips
PL Nożyce do cięcia blachy
DE Blechscherer
RU Ножницы по металлу
CZ Nůžky na plech
HU Lemezvágó olló

RO Foarfece pt. tablă
FR Cisaille à tôle
IT Cesioie per lamiera
ES Tijeras para chapas
CN 铁皮剪



HRC
55-60

S55C

HIGH FREQUENCY
HARDENING
HARTONANIE
IMPULSOWE



YATO	L [mm]	Cutting length / Długość cięcia [mm]	Cooper / Miedz [mm]	Cold rolled steel / Stal zimnowalcowana [mm]	Steel HRC35 / Stal HRC35 [mm]	SS 304 / Stal nierdzewna 304 [mm]	
YT-1970	260	42	2.0	1.4	1.0	1.0	6/36

EN Tin snips
PL Nożyce do cięcia blachy
DE Blechscherer
RU Ножницы по металлу
CZ Nůžky na plech
HU Lemezvágó olló

RO Foarfece pt. tablă
FR Cisaille à tôle
IT Cesioie per lamiera
ES Tijeras para chapas
CN 铁皮剪

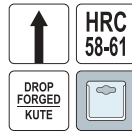

YATO	L [mm]	Cutting length / Długość cięcia [mm]	Cooper / Miedz [mm]	Cold rolled steel / Stal zimnowalcowana [mm]	Steel HRC35 / Stal HRC35 [mm]	SS 304 / Stal nierdzewna 304 [mm]	
YT-1925	225	52	0.94	0.78	0.6	0.45	6/36

EN Tin snips
PL Nożyce do cięcia blachy
DE Blechscherer
RU Ножницы по металлу
CZ Nůžky na plech
HU Lemezvágó olló

RO Foarfece pt. tablă
FR Cisaille à tôle
IT Cesioie per lamiera
ES Tijeras para chapas
CN 铁皮剪



YATO	L [mm]	Cutting length / Długość cięcia [mm]	Cooper / Miedz [mm]	Cold rolled steel / Stal zimnowalcowana [mm]	Steel HRC35 / Stal HRC35 [mm]	SS 304 / Stal nierdzewna 304 [mm]	
YT-1924	254	52	0.94	0.78	0.6	0.45	6/36

EN Tin snips
PL Nożyce do cięcia blachy
DE Blechscherer
RU Ножницы по металлу
CZ Nůžky na plech
HU Lemezvágó olló

RO Foarfece pt. tablă
FR Cisaille à tôle
IT Cesioie per lamiera
ES Tijeras para chapas
CN 铁皮剪



YATO	L [mm]	Cutting length / Długość cięcia [mm]	Cooper / Miedz [mm]	Cold rolled steel / Stal zimnowalcowana [mm]	Steel HRC35 / Stal HRC35 [mm]	SS 304 / Stal nierdzewna 304 [mm]	
YT-1920	260	42	1.2	1.0	0.6	0.5	6/36

EN Tin snips
PL Nożyce do cięcia blachy
DE Blechscherer
RU Ножницы по металлу
CZ Nůžky na plech
HU Lemezvágó olló

RO Foarfece pt. tablă
FR Cisaille à tôle
IT Cesioie per lamiera
ES Tijeras para chapas
CN 铁皮剪



YATO	L [mm]	Cutting length / Długość cięcia [mm]	Cooper / Miedz [mm]	Cold rolled steel / Stal zimnowalcowana [mm]	Steel HRC35 / Stal HRC35 [mm]	SS 304 / Stal nierdzewna 304 [mm]	
YT-1963	200	40	1.5	1.0	0.6	0.6	6/36
YT-1964	250	60	1.8	1.2	0.8	0.8	6/24
YT-1965	300	75	2.0	1.4	0.8	0.8	6/12

EN Metal sheet nibbler
 PL Nożyce matrycowe do blachy
 DE Blechnibbler
 RU Ножницы для резки жести
 CZ Nůžky na plech
 HU Lemezvágó olló
 RO Foarfecă pt. tablă
 FR Grignoleuse a tole
 IT Cesovia roditrice per lamiera
 ES Tijeras para chapas
 CN 法式剪

260 mm max 1.0mm PLATE BLACHA max 1.2mm Al max 2.0mm PLASTIC PLASTIK 3.0 mm CHANGEABLE BLADES WYMIENNE OSTRZA



YATO	L [mm]	
YT-19260	260	6/36

EN Spare blades for metal sheet nibbler
 PL Ostrza zapasowe do nożyc matrycowych
 DE Abbrechklängen für Blechnibbler
 RU Лезвия для ножиц для резки жести
 CZ Ostrří náhradní
 HU Tartalékpenge
 RO Lame de rezervă
 FR Lame sécables pour grignoleuse a tole
 IT Lame di ricambio per cesovia roditrice per lamiera
 ES Cuchillas de recambio
 CN 法式剪备用刀片

3 PCS 65Mn



For YT-19260
 Dia YT-19260

YATO		
YT-19261		10/100

EN Shears for cutting sheet metal
 PL Nożyce krawzkowe do cięcia blach
 DE Rollenblechscher
 RU Дисковые ножницы для резки листового металла
 CZ Kotoučové nůžky na stříhání plechů
 HU Karos lemezvágó olló
 RO Dispozitiv taiat foi de tabla
 FR Cisaille à tôle à molette
 IT Cesovia rotante per lamiera
 ES Cortador rotativo para chapa
 CN 手动钢板剪

120 mm



YATO	L [mm]	Cold rolled steel / Stal zimnowalcowana [mm]	Stainless steel / Stal nierdzewna [mm]	Aluminium [mm]	
YT-18950	120	1.6	1.2	2.0	1

EN Steel strap cutter
 PL Nożyce do cięcia taśmy stalowej
 DE Stahlgurtblechscher
 RU Ножницы для резки стальной ленты
 CZ Nůžky na plech
 HU Lemezvágó olló

HRC 58-61



YATO	L [mm]	Cutting length / Długość cięcia [mm]	Steel HRC35 / Stal HRC35 [mm]	SS 304 / Stal nierdzewna 304 [mm]	
YT-1930	305	28	0.8	0.6	6/24

EN Bolt cutter
 PL Nożyce do drutu
 DE Drahtschere
 RU Болторез
 CZ Nůžky na drát
 HU Drótvágó olló
 RO Clește pt. buleoane
 FR Ciseaux à fil
 IT Cesioie tagliafili
 ES Tijeras para alambre
 CN 断线钳



200 mm max Ø 3.5 mm CrV

YATO	L [mm]	max. Ø [mm]	
YT-18566	200	3.5	6/48

EN Bolt cutter
 PL Nożyce do prętów
 DE Bolzenschneider
 RU Болторез
 CZ Nůžky na tyče
 HU Drótvágó olló

RO Clește pt. buleoane
 FR Coupe-boulon
 IT Tagliabulloni
 ES Cortavarillas
 CN 断线钳

HRC 56-61 CrMo



YATO	L [mm]	Size / Rozmiar	max. Ø soft / maks. Ø miękki [mm]	max. Ø medium / maks. Ø średnio twardy [mm]	
YT-1843	300	12"	5	4	20
YT-1844	350	14"	7	5	10
YT-1845	450	18"	8	6	10
YT-1846	600	24"	10	8	6
YT-1847	750	30"	13	10	4
YT-1848	900	36"	16	12	3

EN Bolt cutter
 PL Nożyce do prętów
 DE Bolzenschneider
 RU Болторез
 CZ Nůžky na tyče
 HU Drótvágó olló

RO Clește pt. buleoane
 FR Coupe-boulon
 IT Tagliabulloni
 ES Cortavarillas
 CN 断线钳

CrMo



YATO	L [mm]	Size / Rozmiar	max. Ø [mm]	
YT-1851	350	14"	6	6/24
YT-1852	450	18"	7	6/12
YT-1853	600	24"	10	2/12
YT-1854	750	30"	12	6
YT-1855	900	36"	14	4
YT-1856	1050	42"	16	2

EN Concrete mesh cutter
 PL Nożyce do siatki zbrojarskiej
 DE Mattenschneider
 RU Ножницы для резки арматурной сетки
 CZ Pákové kleště na pletivo
 HU Gyékényvágó
 RO Clește pt. fier beton
 FR Coupe-trellis
 IT Cesioie per reti di rinforzo
 ES Cortante para varillas de encofrado
 CN 鹰嘴断线钳

800 mm max Ø 11 mm CrV



YATO	L [mm]	
YT-18400	800	5

EN Wire rope cutter
 PL Nożyce do drutu i linek stalowych
 DE Kabel- und Drahtseilschere
 RU Ножницы арматурные
 CZ Štípací kleště na dráty a ocelová lanka
 HU Drótkötél vágó olló
 RO Dispozitiv de taiat frânghie
 FR Pince coupante pour fils et câbles métalliques
 IT Cesioie per fili di ferro e funi di acciaio
 ES Tijeras para alambre y cables de acero
 CN 钢丝绳剪

190 mm max Ø 1.5 mm max Ø 4 mm HRC 58-62 CrV



YATO	Wire max. cutting diameter / Maks. średnica cięcia drutu [mm]	Steel line max. cutting diameter / Maks. średnica cięcia linki stalowej [mm]	
YT-18570	1.5	4	10/60

EN Hydraulic cutter
PL Ręczny obcinak hydrauliczny
DE Manueller Hydraulikschneider
RU Ручной гидравлический резак

CZ Ruční hydraulický odřezávac
HU Kézi hidraulikus betonacélvágó
RO Cutit pt. retezat tevi
FR Coupe manuelle hydraulique

IT Cesovia idraulica manuale
ES Cortadora hidráulica manual
CN 液压剪

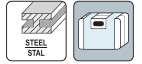

∅ 4-12 mm
320 mm
6t

YATO	Cutting diameter / Średnica cięcia [mm²]	L [mm]	Force pressure / Siła nacisku [t]	
YT-22870	4-12	320	6	5

YATO	Cutting diameter / Średnica cięcia [mm²]	L [mm]	Force pressure / Siła nacisku [t]	
YT-22871	4-16	430	8	5
YT-22872	4-20	515	13	3

EN Heads for hydraulic cutter

PL Noże wymienne do obcinaka hydraulicznego
DE Austauschmesser für Hydraulikschneider
RU Сменные ножи для гидравлического резака
CZ Vyměnitelné nože do hydraulického odřezávac
HU Cserélhető a hidraulikus betonacélvágóhoz
RO Cutter hidraulic pt. cabluri
FR Lame pour coupe manuelle hydraulique
IT Teste per coltelli idraulici
ES Cuchillas intercambiables para cortadora hidráulica
CN 液压钳钳口配件



2
PCS

YATO	Size / Rozmiar [mm]	For / Dla	
YT-22873	12	YT-22870	10/100
YT-22874	16	YT-22871	10/100
YT-22875	20	YT-22872	10/100

EN Hydraulic metal hole puncher

PL Wycinak hydrauliczny otworów w blachach
DE Hydraulischer Blechlocher
RU Инструмент для просекания отверстий гидравлический ручной
CZ Hydraulický vysekávač otvorů v plechu
HU Hidraulikus lemezlyukasztó
RO Perforator hidraulic metallic
FR Emporte-pièce hydraulique à tôle
IT Punzonatrice idraulica per lamiera
ES Cortador hidráulico de agujeros en hojas de chapa
CN 液压开孔器



∅ 22-60 mm

6t

max 3 mm

360°



YATO	Cutting diameter / Średnica cięcia [mm]	Force pressure / Siła nacisku [t]	
YT-18900	22-60	6	2

EN Hydraulic metal hole puncher

PL Wycinak hydrauliczny otworów w blachach
DE Hydraulischer Blechlocher
RU Инструмент для просекания отверстий гидравлический ручной
CZ Hydraulický vysekávač otvorů v plechu
HU Hidraulikus lemezlyukasztó
RO Perforator hidraulic metallic
FR Emporte-pièce hydraulique à tôle
IT Punzonatrice idraulica per lamiera
ES Cortador hidráulico de agujeros en hojas de chapa
CN 液压开孔器



∅ 22-60 mm

6t

max 4 mm



YATO	Cutting diameter / Średnica cięcia [mm]	Force pressure / Siła nacisku [t]	
YT-18907	22-60	6	1

EN Multi-function scissors
 PL Nożyce wielofunkcyjne
 DE Multifunktionsmesser
 RU Ножницы многофункциональные
 CZ Všeúčelové nůžky
 HU Többfunkciós olló
 RO Foarfece multifuncțional
 FR Cisailles universelle
 IT Cesioie multifunzione
 ES Tijeras multifuncionales
 CN 不锈钢多用剪

65/200 mm
 HRC 50-54
 3Cr13



YATO	L [mm]	
YT-1976	200	12/72

EN Multi-function slot angle scissors - professional
 PL Nożyce do cięć kątowych (ukośnych)
 DE Winkelschere (schräg)
 RU Ножницы для резки под углом (по диагонали)
 CZ Nůžky pro šikmé stříhání
 HU Gérvágó olló
 RO Foarfece cu unghi de slot multifuncțional - profesional
 FR Cisailles d'angle
 IT Forbici per tagli angolari (diagonali)
 ES Tijera de inglete
 CN 角度剪

245 mm
 ± 22.5°
 ± 45°
 90°
 SS
 STAINLESS STEEL
 STAL MERCEZINA
 AI



YATO	L [mm]	
YT-18960	245	4/24

EN HD multifunctional scissors
 PL Nożyce techniczne wielofunkcyjne
 DE Multifunktionale technische Schere
 RU Технические многофункциональные ножницы
 CZ Multifunkční technické nůžky
 HU Műszaki olló - multifunkciós
 RO Foarfece multifuncționala HD
 FR Cisailles polyvalentes
 IT Cesioie tecniche multifunzione
 ES Tijera técnica multiusos
 CN 剪刀

250 mm
 SK5
 Cr12Mo



YATO	L [mm]	
YT-18963	250	6/24

EN Hand saw for wood
 PL Pila płatkowa do drewna
 DE Handsäge für Holz
 RU Ручная пила по дереву
 CZ Ruční pila na dřevo
 HU Rókafarkú fűrész
 RO Fierastrău „coada de vulpe” pt. lemn
 FR Scie égoïne à bois
 IT Segaccio per legno
 ES Serrucho para carpintero
 CN 手板锯

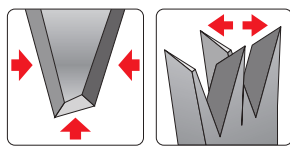

7TPI
 1.6 mm
 0.9 mm
 HRC 50-54
 65Mn



YATO	L [mm]	
YT-3101	400	12/48
YT-3102	450	10/40
YT-3103	500	10/40

EN Hand saw for wood
 PL Pila płatkowa do drewna
 DE Handsäge für Holz
 RU Ручная пила по дереву
 CZ Ruční pila na dřevo
 HU Rókafarkú fűrész
 RO Fierastrău „coada de vulpe” pt. lemn
 FR Scie égoïne à bois
 IT Segaccio per legno
 ES Serrucho para carpintero
 CN 手板锯

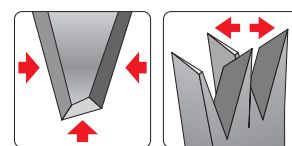

7TPI
 1.6 mm
 0.9 mm
 HRC 50-54
 PTFE
 65Mn



YATO	L [mm]	
YT-3106	400	12/48
YT-3107	450	10/40
YT-3108	500	10/40

EN Hand saw for wood
 PL Pila płatkowa do drewna
 DE Handsäge für Holz
 RU Ручная пила по дереву
 CZ Ruční pila na dřevo
 HU Rókafarkú fűrész

RO Fierastrău „coada de vulpe” pt. lemn
 FR Scie égoïne à bois
 IT Segaccio per legno
 ES Serrucho para carpintero
 CN 手板锯

7TPI
 1.6 mm
 0.9 mm
 PTFE
 65Mn

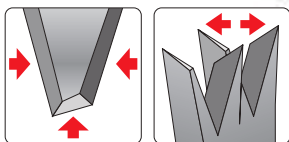

YATO	L [mm]	
YT-31091	400	6/24
YT-31092	450	6/24
YT-31093	500	6/24

EN Hand saw for wood
 PL Pila płatkowa do drewna
 DE Handsäge für Holz
 RU Ручная пила по дереву
 CZ Ruční pila na dřevo
 HU Rókafarkú fűrész

RO Fierastrău „coada de vulpe” pt. lemn
 FR Scie égoïne à bois
 IT Segaccio per legno
 ES Serrucho para carpintero
 CN 手板锯

7TPI
 65Mn
 PTFE

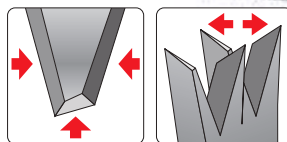

YATO	L [mm]	
YT-31095	350	12/48
YT-31096	400	12/48
YT-31097	450	12/48

EN Back saw for PVC
 PL Pila ręczna do PVC
 DE Handsäge für PVC
 RU Ручная пила для ПВХ
 CZ Ruční pila na PVC
 HU Kézifűrész PVC-hez

RO Fierastrău cu maner PVC
 FR Scie à main pour PVC
 IT Sega a mano per PVC
 ES Sierra de mano para PVC
 CN 锯

PVC
 350/440 mm
 17 TPI
 65Mn



YATO	L [mm]	
YT-31303	440	12/48

EN Japanese saw
 PL Pila japońska
 DE Japanische Handsäge
 RU Ножовка японского типа
 CZ Japonská ruka pila
 HU Japán fűrész

RO Ferăstrău de gips-carton
 FR Scie japonaise
 IT Sega reversibile giapponese
 ES Sierra japonesa
 CN 双面齿拉锯

320/660 mm
 7TPI
 12 TPI
 SK5



YATO	L [mm]	
YT-31310	660	10/40

EN Drywall saw
PL Pila dwustronna do płyt gipsowo-kartonowych
DE Gipskartonsäge
RU Ножовка по гипсокартону

CZ Pila na sádrokarton
HU Gipszkarton fűrész
RO Kézi gipszkarton fűrész
FR Scie à guichet

IT Segna per pannelli in cartongesso
ES Serrucho para placas de yeso
CN 墙锯



180/315
mm

7 TPI

65Mn



YATO	L [mm]	
YT-31343	315	12/96

EN Saw with adjustable handle
PL Pila z przestawianą rękojmią
DE Säge mit verstellbarem Griff
RU Пила с регулируемой ручкой
CZ Pila s nastaviteľnou rukojeťou
HU Fűrész állítható markolattal

RO Fierastrău cu maner reglabil
FR Scie à poignée réglable
IT Segna con maniglia regolabile
ES Sierra con mango móvil
CN 调节锯

250/410
mm

12
TPI

0,6 mm



YATO	L [mm]	
YT-31290	410	6/48

EN Back saw
PL Pila grzbietnica
DE Rücksäge
RU Пила для ступа

CZ Pila hřebenovka
HU Kézifűrész
RO Ferăstrău coadă de vulpe
FR Scie

IT Segna con dorso
ES Serrucho de costilla
CN 夹背锯

300
mm

12
TPI



HRC
50-54

65Mn



YATO	L [mm]	
YT-3130	300	12/60

EN Compass saw
PL Pila otwornica
DE Stichsäge

RU Выкружная пила
CZ Pila otvornice
HU Lyukfűrész

RO Ferăstrău coadă de șoarece
FR Scie étroite
IT Segna a foretto

ES Serrucho de punta
CN 鸡尾锯

300
mm

7 TPI



HRC
50-54

65Mn

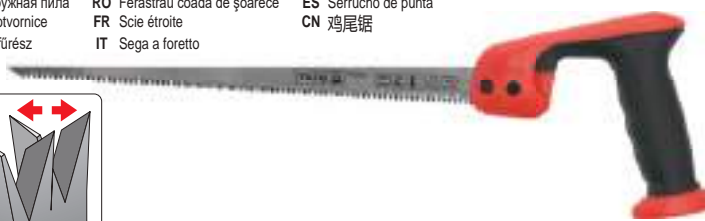
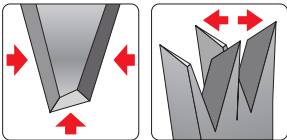

YATO	L [mm]	
YT-3133	300	12/60

EN Wallboard saw
PL Pila do gipsów
DE Gipsäge

RU Ножовка по гипсокартону
CZ Pila na sádro
HU Gipszfűrész

RO Ferăstrău pt. ghips
FR Scie pour plaques de plâtre
IT Segna per cartongesso

ES Serrucho para cartón yeso
CN 墙板锯

160/300
mm

7 TPI



HRC
50-54

65Mn

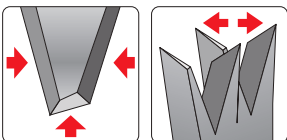

YATO	L [mm]	
YT-3134	300	12/60

EN Plastic miter box with dovetail saw
PL Plastikowa skrzynka uciosowa z piłą
DE Kunststoffschneidladen mit Säge

RU Стусно пластмассовое с пилой
CZ Přípravek na fezáni úhlů s pilkou
HU Gérbevágó műanyagládá hódírfarkú fűrészszel
RO Fierastrău cu dispozitiv de taiat la unghi
FR Boîte à onglets + scie
IT Taglia cornici in plastica con sega
ES Guía de ingletar y sierra
CN 燕尾锯

350
mm

12
TPI

1,2 mm
0,8 mm

HRC
50-54

65Mn

300x140
x70
mm

ABS



YATO	L [mm]	
YT-3150	350	10

EN Bow saw
PL Pila kabłąkowa
DE Bügelsäge
RU Лучковая пила
CZ Oblouková pila
HU Keretes fűrész

RO Ferăstrău de curbură
FR Scie à bûches
IT Segna ad arco
ES Sierra de arco
CN 两用弓锯

HCS65

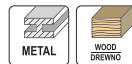

YATO	L [mm]	
YT-3200	300	12/24

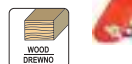

YATO	L [mm]	
YT-3201	450	12/24
YT-3202	530	12/24
YT-3203	610	12/24
YT-3204	760	12/24

EN Bow saw blade for dry wood
 PL Brzeszczot do drewna suchego
 DE Bùgelsàgeblatt für trockenenes Holz
 RU Полотно для лучковой пилы по сухому дереву
 CZ Pílový list na suché dřevo
 HU Keretes fűrészhöz fűrészlap száraz fához

RO Lamă pt. lemn uscat
 FR Lama pour bois sec
 IT Lama per legno secco
 ES Hoja de sierra para madera seca
 CN 干木锯条



EN Bow saw blade for wet wood
 PL Brzeszczot do drewna mokrego
 DE Bùgelsàgeblatt für frisches Holz
 RU Полотно для лучковой пилы по влажному дереву
 CZ Pílový list na mokré dřevo
 HU Keretes fűrészhöz fűrészlap nedves fához

RO Lamă pt. lemn verde
 FR Lama pour bois humide
 IT Lama per legno bagnato
 ES Hoja de sierra para madera húmeda
 CN 湿木锯条

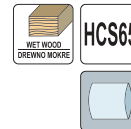

YATO	L [mm]	
YT-3221	450	50/200
YT-3222	530	50/200
YT-3223	610	50/200
YT-3224	760	50/200



YATO	L [mm]	
YT-3230	300	50/200
YT-3231	450	50/200
YT-3232	530	50/200
YT-3233	610	50/200
YT-3234	760	50/200

EN Hacksaw frame
 PL Píla do metalu
 DE Metallbogensàge
 RU Пила по металлу

CZ Pílika na železo
 HU Fémfűrés
 RO Feràstrău cu cadru metalic
 FR Scie à métal

IT Seghetto per metallo
 ES Sierra de metalo
 CN 锯架

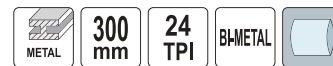

YATO	L [mm]	
YT-3160	300	10

YATO	L [mm]	
YT-3161	300	6/36

YATO	L [mm]	
YT-3163	300	5/20

EN Metal hacksaw
 PL Píla do metalu
 DE Metallsàge
 RU Ножовка по металлу
 CZ Píla na kov
 HU Fémfűrés
 RO Feràstrău metalic
 FR Scie à métaux
 IT Seghetto per metallo
 ES Sierra para metales
 CN 金属钢锯



YATO	L [mm]	
YT-31612	300	12/36

EN Hacksaw frame blade
 PL Brzeszczot do metalu
 DE Metallsàgeblatt
 RU Полотно по металлу

CZ Pílový list na kovy
 HU Fémfűrés lap
 RO Panza fieràstrau pt. metal
 FR Lame à métal

IT Lama per metallo
 ES Hoja de sierra para metalo
 CN 弹性锯条

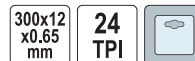

YATO	L [mm]	W [mm]	TPI	pcs / szt.	
YT-3460	300	12	24	5	10/200



YATO	L [mm]	W [mm]	TPI	pcs / szt.	
YT-3461	300	12	24	2	20/500

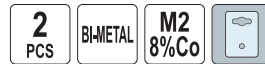

YATO	L [mm]	W [mm]	TPI	pcs / szt.	
YT-3462	300	12	24	2	20/500

EN Band saw blade
 PL Brzeszczot do pily taśmowej
 DE Bandsàgeblàtter
 RU Полотно для ленточной пилы
 CZ Pílový pás na pásovou pílu
 HU Szalagfűrészlap
 RO Panza pt. fieràstrau cu banda
 FR Lame de scie à ruban
 IT Lama per sega a nastro
 ES Hoja de sierra de cinta
 CN 带锯锯条



For YT-82185
 Dla YT-82185

YATO	L [mm]	W [mm]	TPI	
YT-82189	1140	0.65	14	20

EN Jig saw blades
 PL Brzeszczoty do wyrzynarki
 DE Stichsàgeblàtter
 RU Полотно для пневматической сабельной пилы
 CZ Pílový list do přímotarář píly
 HU Dekopírlap

RO Set pânze pt. fieràstrău sabie
 FR Lama pour scie sauteuse
 IT Lama per seghetti pneumatici
 ES Recambio sierra de calar
 CN 锯片



For YT-09955
 Dla YT-09955

YATO	TPI	
YT-09958	24	50/200
YT-09959	32	50/200

EN Sabre saw blade
PL Brzeszczot do cegieł i pustaków
DE Säbelsägeblatt
RU Пильное полотно

CZ Pílový plátek do pily ocasky
HU Szablyafűrészlap
RO Pânză pt. fierăstrău sabie
FR Lames scie sabre

IT Lama per mattoni e mattoni cavi
ES Hoja de sierra sable
CN 硬质合金锯条

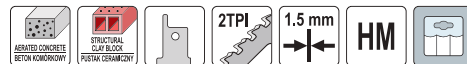

YATO	L [mm]	
YT-33951	300	20/100
YT-33950	455	25/100

EN Sabre saw blade
PL Brzeszczot do pily szablastej
DE Säbelsägeblatt
RU Пильное полотно
CZ Pílový plátek do pily ocasky
HU Szablyafűrészlap

RO Pânză pt. fierăstrău sabie
FR Lames scie sabre
IT Lama per sega a lama oscillante
ES Hoja de sierra sable
CN 碳钢往复锯条

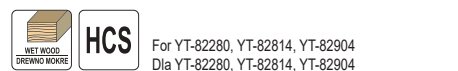

YATO	L [mm]	+/- [mm]	TPI	
YT-33920	300	1.45	5	50/100

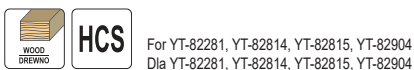

YATO	L [mm]	+/- [mm]	TPI	
YT-33921	150	1.2	4	50/200
YT-33922	150	1.0	6	50/200
YT-33923	150	1.0	8	50/200



YATO	L [mm]	+/- [mm]	TPI	
YT-33930	150	1.0	10	50/200



YATO	L [mm]	+/- [mm]	TPI	
YT-33931	150	1.0	18	50/200
YT-33932	150	1.0	24	50/200



YATO	L [mm]	+/- [mm]	TPI	
YT-33933	225	1.0	10	50/200



YATO	L [mm]	+/- [mm]	TPI	
YT-33934	225	1.0	24	50/200



YATO	L [mm]	+/- [mm]	TPI	
YT-33935	300	1.25	6	50/100

EN Sabre saw blade
PL Brzeszczot do pily szablastej
DE Säbelsägeblatt
RU Пильное полотно
CZ Pílový plátek do pily ocasky
HU Szablyafűrészlap

RO Lamă fierăstrău sabie
FR Lame de scie sabre
IT Lama per sega a gattuccio
ES Hoja de sierra sable
CN 往复锯条

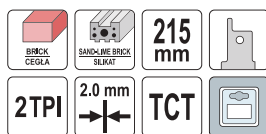

YATO	L [mm]	+/- [mm]	TPI	
YT-33960	215	2.0	2	100/200

EN Sabre saw blade
PL Brzeszczot do pily szablastej
DE Säbelsägeblatt
RU Пильное полотно
CZ Pílový plátek do pily ocasky
HU Szablyafűrészlap

RO Lamă fierăstrău sabie
FR Lame de scie sabre
IT Lama per sega a gattuccio
ES Hoja de sierra sable
CN 往复锯条

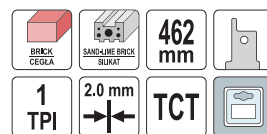

YATO	L [mm]	+/- [mm]	TPI	
YT-33961	462	2.0	1	25/50

EN Sabre saw blade
PL Brzeszczot do pily szablastej
DE Säbelsägeblatt
RU Пильное полотно
CZ Pílový plátek do pily ocasky
HU Szablyafűrészlap
RO Lamă fierăstrău sabie
FR Lame de scie sabre
IT Lama per sega a gattuccio
ES Hoja de sierra sable
CN 往复锯条



• For straight cuts
• Doesn't bend when cuts

• Do cięć na wprost
• Nie wygina się podczas cięcia

For YT-82281, YT-82814, YT-82815, YT-82904
Dla YT-82281, YT-82814, YT-82815, YT-82904

YATO	L [mm]	+/- [mm]	TPI	
YT-33970	230	1.0	12	10/80

EN Sabre saw blade
PL Brzeszczot do pily szablastej
DE Säbelsägeblatt
RU Пильное полотно
CZ Pílový plátek do pily ocasky
HU Szablyafűrészlap
RO Lamă fierăstrău sabie
FR Lame de scie sabre
IT Lama per sega a gattuccio
ES Hoja de sierra sable
CN 往复锯条



• For straight cuts
• Doesn't bend when cuts

• Do cięć na wprost
• Nie wygina się podczas cięcia

For YT-82281, YT-82814, YT-82815, YT-82904
Dla YT-82281, YT-82814, YT-82815, YT-82904

YATO	L [mm]	+/- [mm]	TPI	
YT-33971	230	1.2	6	10/100

EN Sabre saw blade
 PL Brzeszczot do pily szablastej
 DE Säbelsägeblatt
 RU Пильное полотно
 CZ Pílový plátek do pily oscaky
 HU Szablyafűrészlap

RO Lamă fierăstrău sabie
 FR Lame de scie sabre
 IT Lama per sega a gattuccio
 ES Hoja de sierra sable
 CN 往复锯条



120 mm 12 TPI 1.2 mm

For YT-82281, YT-82814, YT-82815, YT-82904
 Dla YT-82281, YT-82814, YT-82815, YT-82904

• For plunge and curve cuts
 • Do cięć wgnębných i po łuku

YATO	L [mm]	+/- [mm]	TPI	
YT-33972	120	1.2	12	10/100

EN Jig saw blades
 PL Brzeszczoty do wyrzynarki
 DE Stichsägeblätter

RU Полотно для электр. станка
 CZ Pílový list do přimočaré pily
 HU Dekopírlap

RO Lama fierastrau pendular
 FR Lames à scie sauteuse
 IT Scalpelli per il seghetto

ES Recambio sierra de calar
 CN 曲线锯条

5 PCS



YATO	L [mm]	Working length / Długość robocza [mm]	+/- [mm]	TPI	
YT-3400	100	75	1.27	6	50/250

YATO	L [mm]	Working length / Długość robocza [mm]	+/- [mm]	TPI	
YT-3401	100	75	1.3	10	50/250



YATO	L [mm]	Working length / Długość robocza [mm]	+/- [mm]	TPI	
YT-3402	100	75	1.2	8	50/250

YATO	L [mm]	Working length / Długość robocza [mm]	+/- [mm]	TPI	
YT-3403	100	75	1.3	6	50/250



YATO	L [mm]	Working length / Długość robocza [mm]	+/- [mm]	TPI	
YT-3404	100	75	1.3	10	50/250

YATO	L [mm]	Working length / Długość robocza [mm]	+/- [mm]	TPI	
YT-3405	100	75	1.3	6	50/250



YATO	L [mm]	Working length / Długość robocza [mm]	+/- [mm]	TPI	
YT-3407	75	50	1.0	13	50/250

YATO	L [mm]	Working length / Długość robocza [mm]	+/- [mm]	TPI	
YT-3408	115	90	1.3	13-8	50/250



YATO	L [mm]	Working length / Długość robocza [mm]	+/- [mm]	TPI	
YT-3409	115	90	1.3	8	50/250

YATO	L [mm]	Working length / Długość robocza [mm]	+/- [mm]	TPI	
YT-3410	100	75	1.4	6	50/250

EN Jig saw blades
PL Brzeszczoty do wyrzynarki
DE Stichsägeblätter

RU Полотно для электр. станка
CZ Pilový list do přimočaré pily
HU Dekopírlap

RO Lama fierastrau pendular
FR Lames à scie sauteuse
IT Scalpelli per il seghetto

ES Recambio sierra de calar
CN 曲线锯条

5
PCS

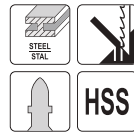
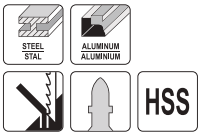

YATO	L [mm]	Working length / Długość robocza [mm]	+ - [mm]	TPI	Icon
YT-3411	100	75	1.0	8	25/250

YATO	L [mm]	Working length / Długość robocza [mm]	+ - [mm]	TPI	Icon
YT-3412	75	50	1.0	21	25/250



YATO	L [mm]	Working length / Długość robocza [mm]	+ - [mm]	TPI	Icon
YT-3413	75	50	1.0	12	25/250

YATO	L [mm]	Working length / Długość robocza [mm]	+ - [mm]	TPI	Icon
YT-3414	75	50	1.0	32	25/250

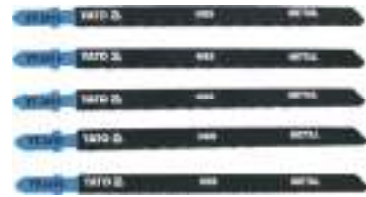
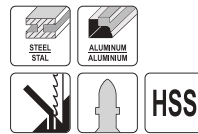
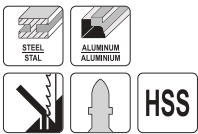

YATO	L [mm]	Working length / Długość robocza [mm]	+ - [mm]	TPI	Icon
YT-3415	100	75	1.0	24-10	25/250

YATO	L [mm]	Working length / Długość robocza [mm]	+ - [mm]	TPI	Icon
YT-3416	130	106	1.0	21	25/250

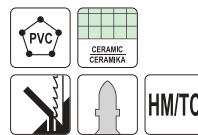
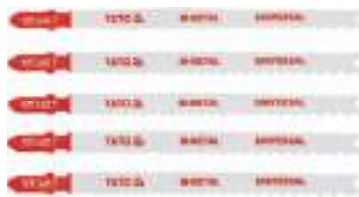
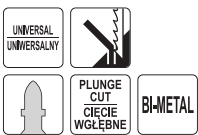

YATO	L [mm]	Working length / Długość robocza [mm]	+ - [mm]	TPI	Icon
YT-3417	130	106	1.27	10-5	25/250

YATO	L [mm]	Working length / Długość robocza [mm]	+ - [mm]	TPI	Icon
YT-3421	75	50	1.2	25/250	

EN Jig saw blades
PL Brzeszczoty do wyrzynarki
DE Stichsägeblätter
RU Пилки для лобзика
CZ Pilový list do přimočaré pily
HU Dekopírlap
RO Lama fierastrau pendular
FR Lames à scie sauteuse
IT Scalpelli per il seghetto
ES Recambio sierra de calar
CN 曲线锯条套装

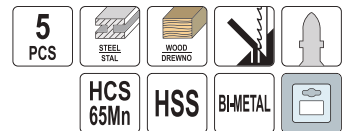

YATO	L [mm]	Working length / Długość robocza [mm]	+ - [mm]	TPI	Icon
YT-3445	100, 100, 100, 75, 75	75, 75, 75, 50, 57	1.3, 1.3, 1.27, 1.0, 1.0	10, 6, 10, 32, 12	25/250

EN Half-moon saw blade for oscillating multitool HSS
 PL Brzeszczot okrągły HSS do narzędzia wielofunkcyjnego
 DE Rundes Sägeblatt HSS für Multifunktionswerkzeug
 RU Диское полотно HSS для многофункционального инструмента
 CZ Segmentový pilový list HSS pro multifunkční nářadí
 HU HSS kör keresztmetszetű fűrészlap multifunkciós szerszámhoz
 RO Lamă rotundă HSS pt. unealta multifuncțională
 FR Lame segment HSS pour outil multifonction
 IT Lama di sega circolare per lo strumento multi-funzione HSS
 ES Hoja redonda HSS para herramienta multifuncional
 CN 半圆形摆动锯

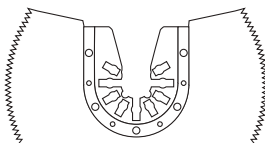
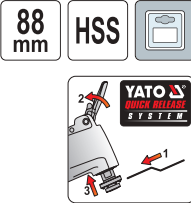

88 mm

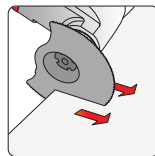

• Application: wood, plastic, soft metal, plaster
 • Zastosowanie: drewno, plastik, miękki metal, gips

For YT-82220, YT-82223, YT-82818, YT-82900
 Dla YT-82220, YT-82223, YT-82818, YT-82900

YATO  
 YT-34680 5/100

EN Half-moon saw blade for oscillating multitool HCS
 PL Brzeszczot okrągły HCS do narzędzia wielofunkcyjnego
 DE Rundes Sägeblatt HCS für Multifunktionswerkzeug
 RU Диское полотно HCS для многофункционального инструмента
 CZ Segmentový pilový list HCS pro multifunkční nářadí
 HU HCS kör keresztmetszetű fűrészlap multifunkciós szerszámhoz
 RO Lamă rotundă HCS pt. unealta multifuncțională
 FR Lame segment HCS pour outil multifonction
 IT Lama di sega circolare per lo strumento multi-funzione HCS
 ES Hoja redonda HCS para herramienta multifuncional
 CN 高碳钢扇型锯片

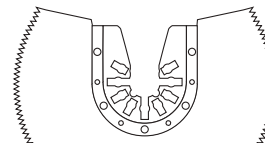
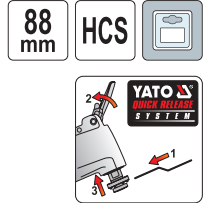

88 mm

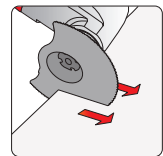

• Application: wood, plastic, soft metal, plaster
 • Zastosowanie: drewno, plastik, miękki metal, gips

For YT-82220, YT-82223, YT-82818, YT-82900
 Dla YT-82220, YT-82223, YT-82818, YT-82900

YATO  
 YT-34681 5/100

EN Brazed carbide d-shape blade for oscillating multitool HM
 PL Brzeszczot okrągły HM do narzędzia wielofunkcyjnego
 DE Rundes Sägeblatt HM für Multifunktionswerkzeug
 RU Диское полотно HM для многофункционального инструмента
 CZ Segmentový pilový list HM pro multifunkční nářadí
 HU HM kör keresztmetszetű fűrészlap multifunkciós szerszámhoz
 RO Lamă rotundă HM pt. unealta multifuncțională
 FR Lame segment HM pour outil multifonction
 IT Lama di sega circolare per lo strumento multi-funzione HM
 ES Hoja redonda HM para herramienta multifuncional
 CN 摆动锯

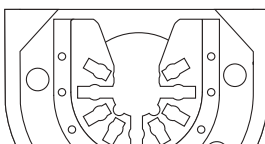
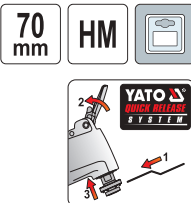

70 mm

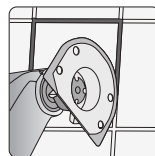

• Application: concrete, ceramic materials, epoxy resin, fibreglass
 • Zastosowanie: beton, materiały ceramiczne, żywica epoksydowa, włókno szklane

For YT-82220, YT-82223, YT-82818, YT-82900
 Dla YT-82220, YT-82223, YT-82818, YT-82900

YATO  
 YT-34682 10/100

EN Half-moon saw blade for oscillating multitool BIM
 PL Brzeszczot półokrągły BIM do narzędzia wielofunkcyjnego
 DE Rundes Sägeblatt BIM für Multifunktionswerkzeug
 RU Диское полотно BIM для многофункционального инструмента
 CZ Segmentový pilový list BIM pro multifunkční nářadí
 HU BIM kör keresztmetszetű fűrészlap multifunkciós szerszámhoz
 RO Lamă rotundă BIM pt. unealta multifuncțională
 FR Lame segment BIM pour outils multifonctions
 IT Lama di sega circolare per lo strumento multi-funzione BIM
 ES Hoja redonda BIM para herramienta multifuncional
 CN 多功能锯片

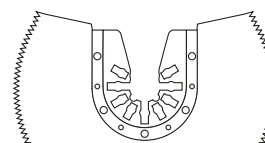
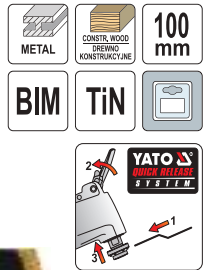

100 mm

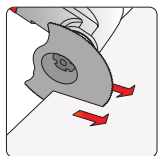

• Application: wood, metal
 • Zastosowanie: drewno, metal

For YT-82220
 Dla YT-82220

YATO  
 YT-34711 10/100

EN Half-moon saw blade for oscillating multitool BIM
 PL Brzeszczot półokrągły BIM do narzędzia wielofunkcyjnego
 DE Rundes Sägeblatt BIM für Multifunktionswerkzeug
 RU Диское полотно BIM для многофункционального инструмента
 CZ Segmentový pilový list BIM pro multifunkční nářadí
 HU BIM kör keresztmetszetű fűrészlap multifunkciós szerszámhoz
 RO Lamă rotundă BIM pt. unealta multifuncțională
 FR Lame segment BIM pour outils multifonctions
 IT Lama di sega circolare per lo strumento multi-funzione BIM
 ES Hoja redonda BIM para herramienta multifuncional
 CN 多功能锯片

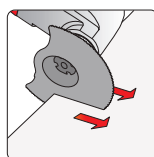
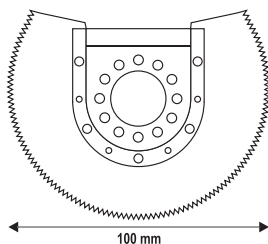
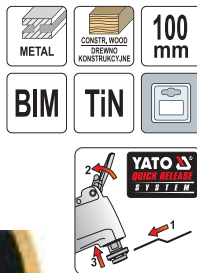

• Application: wood, metal
 • Zastosowanie: drewno, metal

For YT-82223
 Dla YT-82223



EN Plunge cutting saw blade for oscillating multitool BIM
 PL Brzeszczot wgłębny BIM do narzędzia wielofunkcyjnego
 DE Tiefenmesser BIM für Multifunktionswerkzeug
 RU Сабельное полотно BIM для многофункционального инструмента
 CZ Pilový list BIM na ponorné řezy pro multifunkční nářadí
 HU BIM merülő fűrészlap multifunkciós szerszámhoz
 RO Lamă de adâncime BIM pt. unealta multifuncțională
 FR Lame scie plongeante BIM pour outil multifonction
 IT Lama per tagli dal pieno BIM
 ES Hoja para cortes profundos BIM para herramienta multifuncional
 CN 锯片

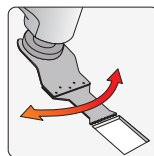
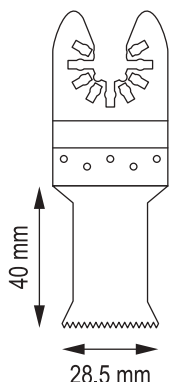
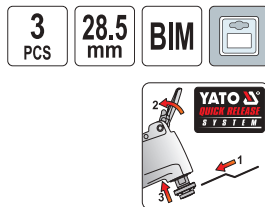

• Application: wood, plastic, metal, plaster, epoxy resin
 • Zastosowanie: drewno, plastik, metal, gips, żywica epoksydowa

For YT-82220, YT-82223, YT-82818, YT-82900
 Dla YT-82220, YT-82223, YT-82818, YT-82900



EN Plunge cutting saw blade for oscillating multitool BIM
 PL Brzeszczot wgłębny BIM do narzędzia wielofunkcyjnego
 DE Tiefenmesser BIM für Multifunktionswerkzeug
 RU Сабельное полотно BIM для многофункционального инструмента
 CZ Pilový list BIM na ponorné řezy pro multifunkční nářadí
 HU BIM merülő fűrészlap multifunkciós szerszámhoz
 RO Lamă de adâncime BIM pt. unealta multifuncțională
 FR Lame scie plongeante BIM pour outil multifonction
 IT Lama per tagli dal pieno BIM
 ES Hoja para cortes profundos BIM para herramienta multifuncional
 CN 锯片

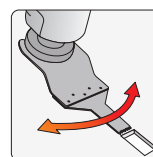
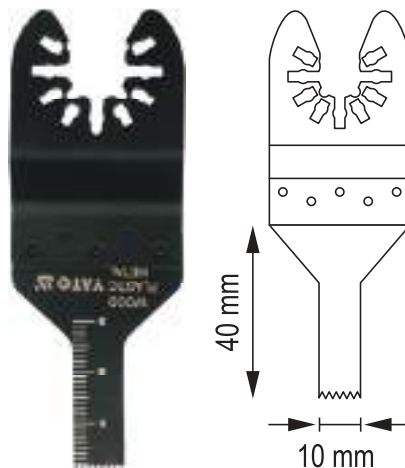
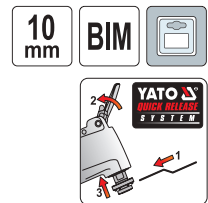

• Application: wood, plastic, metal, plaster, epoxy resin
 • Zastosowanie: drewno, plastik, metal, gips, żywica epoksydowa

For YT-82220, YT-82223, YT-82818, YT-82900
 Dla YT-82220, YT-82223, YT-82818, YT-82900



EN Plunge cutting saw blade for oscillating multitool HCS
 PL Brzeszczot wgłębny HCS do narzędzia wielofunkcyjnego
 DE Tiefenmesser HCS für Multifunktionswerkzeug
 RU Сабельное полотно HCS для многофункционального инструмента
 CZ Pilový list HCS na ponorné řezy pro multifunkční nářadí
 HU HCS merülő fűrészlap multifunkciós szerszámhoz
 RO Lamă de adâncime HCS pt. unealta multifuncțională
 FR Lame scie plongeante HCS pour outil multifonction
 IT Lama per tagli dal pieno HCS
 ES Hoja para cortes profundos HCS para herramienta multifuncional
 CN 锯片

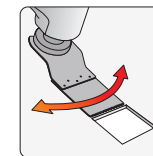
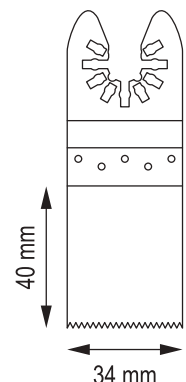
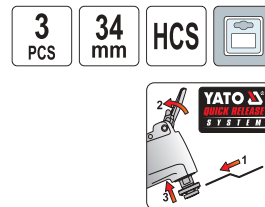

• Application: wood, plastic, plaster
 • Zastosowanie: drewno, plastik, gips

For YT-82220, YT-82223, YT-82818, YT-82900
 Dla YT-82220, YT-82223, YT-82818, YT-82900



EN Plunge cutting saw blade for oscillating multitool BIM
 PL Brzeszczot wgłębny BIM do narzędzia wielofunkcyjnego
 DE Tiefenmesser BIM für Multifunktionswerkzeug
 RU Сабельное полотно BIM для многофункционального инструмента
 CZ Pílový list BIM na ponorné fezy pro multifunkční nářadí
 HU BIM merülő fűrészlap multifunkciós szerszámhoz
 RO Lamă de adâncime BIM pt. unealta multifuncțională
 FR Lame plongeante BIM pour outils multifonctions
 IT Lama per tagli dal pieno BIM
 ES Hoja para cortes profundos BIM para herramienta multifuncional
 CN 锯片

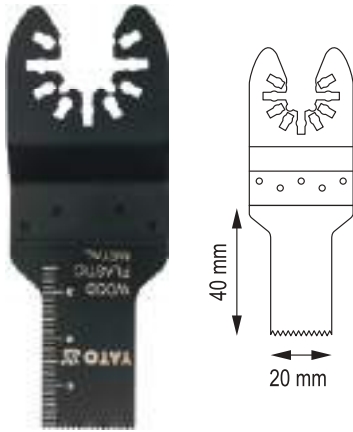
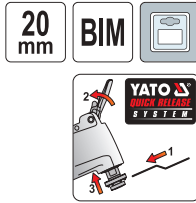

• Application: wood, plastic, metal, plaster, epoxy resin
 • Zastosowanie: drewno, plastik, metal, gips, żywica epoksydowa

For YT-82220, YT-82223, YT-82818, YT-82900
 Dla YT-82220, YT-82223, YT-82818, YT-82900

YATO 5/100
YT-34686

EN Plunge cutting saw blade for oscillating multitool BIM
 PL Brzeszczot wgłębny BIM do narzędzia wielofunkcyjnego
 DE Tiefenmesser BIM für Multifunktionswerkzeug
 RU Сабельное полотно BIM для многофункционального инструмента
 CZ Pílový list BIM na ponorné fezy pro multifunkční nářadí
 HU BIM merülő fűrészlap multifunkciós szerszámhoz
 RO Lamă de adâncime BIM pt. unealta multifuncțională
 FR Lame plongeante BIM pour outils multifonctions
 IT Lama per tagli dal pieno BIM
 ES Hoja para cortes profundos BIM para herramienta multifuncional
 CN 锯片

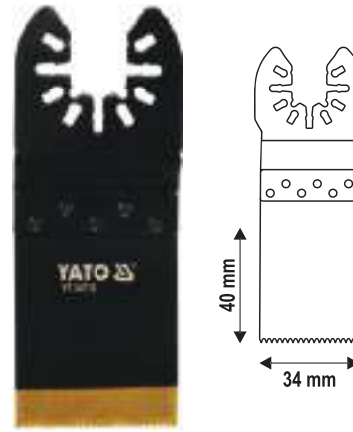
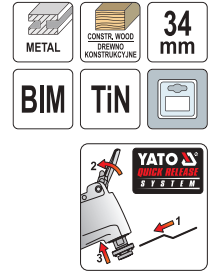

• Application: wood, metal
 • Zastosowanie: drewno, metal

For YT-82220
 Dla YT-82220

YATO 10/100
YT-34712

EN Plunge cutting saw blade for oscillating multitool HCS
 PL Brzeszczot wgłębny HCS do narzędzia wielofunkcyjnego
 DE Tiefenmesser HCS für Multifunktionswerkzeug
 RU Сабельное полотно HCS для многофункционального инструмента
 CZ Pílový list HCS na ponorné fezy pro multifunkční nářadí
 HU HCS merülő fűrészlap multifunkciós szerszámhoz
 RO Lamă de adâncime HCS pt. unealta multifuncțională
 FR Lame plongeante HCS pour outils multifonctions
 IT Lama per tagli dal pieno HCS
 ES Hoja para cortes profundos HCS para herramienta multifuncional
 CN 锯片

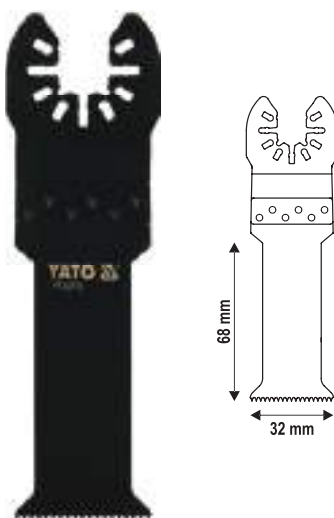

• Application: wood, laminate, plastic
 • Zastosowanie: drewno, laminat, plastik

For YT-82220
 Dla YT-82220

YATO 10/100
YT-34710

EN Plunge cutting saw blade for oscillating multitool HCS
 PL Brzeszczot wgłębny HCS do narzędzia wielofunkcyjnego
 DE Tiefenmesser HCS für Multifunktionswerkzeug
 RU Сабельное полотно HCS для многофункционального инструмента
 CZ Pílový list HCS na ponorné fezy pro multifunkční nářadí
 HU HCS merülő fűrészlap multifunkciós szerszámhoz
 RO Lamă de adâncime HCS pt. unealta multifuncțională
 FR Lame plongeante HCS pour outils multifonctions
 IT Lama per tagli dal pieno HCS
 ES Hoja para cortes profundos HCS para herramienta multifuncional
 CN 锯片

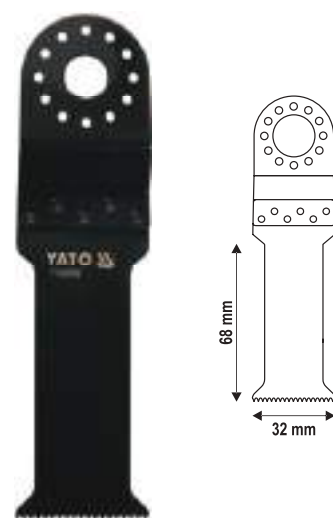
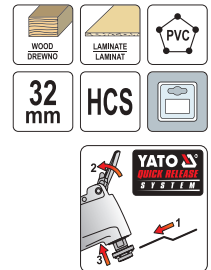

• Application: wood, laminate, plastic
 • Zastosowanie: drewno, laminat, plastik

For YT-82223
 Dla YT-82223

YATO 10/100
YT-34700

EN Plunge cutting saw blade for oscillating multitool BIM
 PL Brzeszczot wgłębny BIM do narzędzia wielofunkcyjnego
 DE Tiefenmesser BIM für Multifunktionswerkzeug
 RU Сабельное полотно BIM для многофункционального инструмента
 CZ Pílový list BIM na ponorné fezy pro multifunkční nářadí
 HU BIM merülő fűrészlap multifunkciós szerszámhoz
 RO Lamă de adâncime BIM pt. unealta multifuncțională
 FR Lame plongeante BIM pour outils multifonctions
 IT Lama per tagli dal pieno BIM
 ES Hoja para cortes profundos BIM para herramienta multifuncional
 CN 锯片

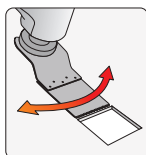
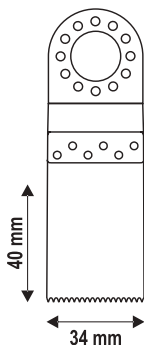
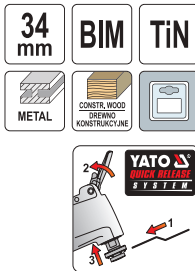

• Application: wood, metal
 • Zastosowanie: drewno, metal

For YT-82223
 Dla YT-82223



EN Plunge cutting saw blade for oscillating multitool BIM
 PL Brzeszczot wgłębny BIM do narzędzia wielofunkcyjnego
 DE Tiefenmesser BIM für Multifunktionswerkzeug
 RU Сабельное полотно BIM для многофункционального инструмента
 CZ Pílový list BIM na ponorné fezy pro multifunkční nářadí
 HU BIM merülő fűrészlap multifunkciós szerszámhoz
 RO Lamă de adâncime BIM pt. unealta multifuncțională
 FR Lame plongeante BIM pour outils multifonctions
 IT Lama per tagli dal pieno BIM
 ES Hoja para cortes profundos BIM para herramienta multifuncional
 CN 锯片

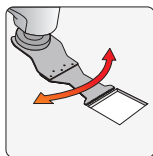
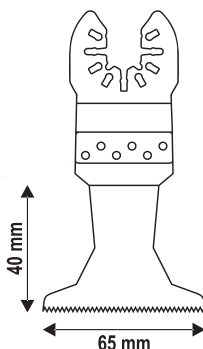
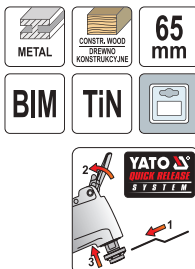

• Application: wood, metal
 • Zastosowanie: drewno, metal

For YT-82220
 Dla YT-82220



EN Plunge cutting saw blade for oscillating multitool BIM
 PL Brzeszczot wgłębny BIM do narzędzia wielofunkcyjnego
 DE Tiefenmesser BIM für Multifunktionswerkzeug
 RU Сабельное полотно BIM для многофункционального инструмента
 CZ Pílový list BIM na ponorné fezy pro multifunkční nářadí
 HU BIM merülő fűrészlap multifunkciós szerszámhoz
 RO Lamă de adâncime BIM pt. unealta multifuncțională
 FR Lame plongeante BIM pour outils multifonctions
 IT Lama per tagli dal pieno BIM
 ES Hoja para cortes profundos BIM para herramienta multifuncional
 CN 锯片

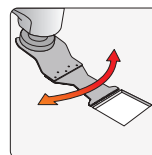
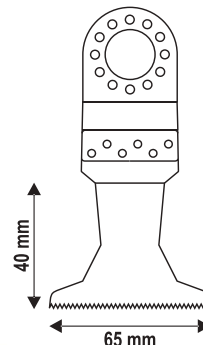
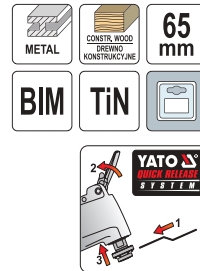

• Application: wood, metal
 • Zastosowanie: drewno, metal

For YT-82223
 Dla YT-82223



EN Brazed carbide triangular rasp for oscillating multitool
 PL Tarnik trójkątny do narzędzia wielofunkcyjnego
 DE Dreieckige Raspel für Multifunktionswerkzeug
 RU Треугольный рашпиль для многофункционального инструмента
 CZ Trojúhelníková brusná deska pro multifunkční nářadí
 HU Háromszög keresztmetszetű reszelő multifunkciós szerszámhoz
 RO Raspel triunghiular pt. unealta multifuncțională
 FR Plateau de ponçage à concretion carbure pour outil multifonction
 IT Raspa in metallo duro forma triangolare multi-funzione
 ES Escofo na triangular para herramienta multifuncional
 CN 锯片

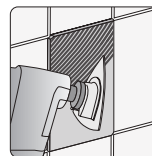
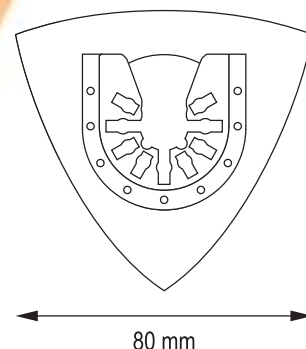
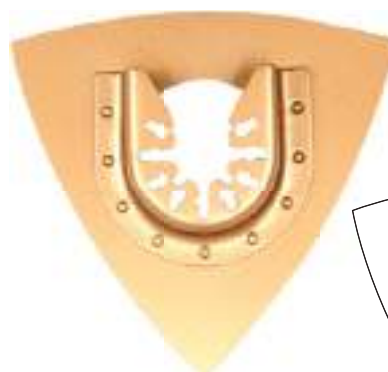
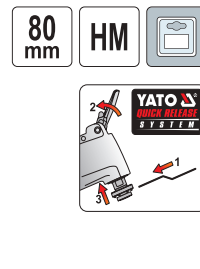

• Application: concrete, ceramic materials
 • Zastosowanie: beton, materiały ceramiczne

For YT-82220, YT-82223, YT-82818, YT-82900
 Dla YT-82220, YT-82223, YT-82818, YT-82900



EN Short scraper for oscillating multitool
 PL Skrobak do narzędzia wielofunkcyjnego
 DE Schaber für Multifunktionswerkzeug
 RU Скребок для многофункционального инструмента
 CZ Škrabka pro multifunkční nářadí
 HU Kaparó multifunkciós szerszámhoz
 RO Răzuitor pt. unealta multifuncțională
 FR Spatule pour outil multifonction
 IT Raschietto oscillante multifunzione adatto
 ES Raspador para herramienta multifuncional
 CN 锯片



52 mm

HCS

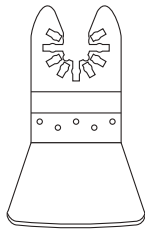

52 mm

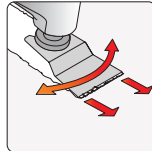

• Application: paint, adhesives, sealing compounds
 • Zastosowanie: farby, kleje, masy uszczelniające

For YT-82220, YT-82223, YT-82818, YT-82900
 Dla YT-82220, YT-82223, YT-82818, YT-82900

YATO  
YT-34688 10/100

EN Triangular eva sanding pad for oscillating multitool
 PL Stopa szlifierska do narzędzia wielofunkcyjnego
 DE Schleifplatte für Multifunktionswerkzeug
 RU Шлифовальная насадка для многофункционального инструмента
 CZ Brusný nástavec pro multifunkční nářadí
 HU Csiszoló talp multifunkciós szerszámhoz
 RO Picior de sablare pt. unealta multifuncțională
 FR Plateau de ponçage pour outil multifonction
 IT Tasso di smerigliatrice multifunzionale
 ES Pie de rectificación para herramienta multifuncional
 CN 抛光盘



90 mm

EVA

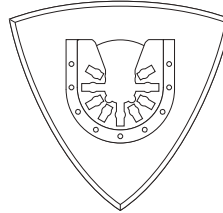

90 mm

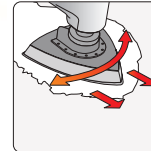

• Application: wood, metal, plaster
 • Zastosowanie: drewno, metal, gips

For YT-82220, YT-82223, YT-82818, YT-82900
 Dla YT-82220, YT-82223, YT-82818, YT-82900

YATO  
YT-34689 10/100

EN Triangular sanding pad for oscillating multitool
 PL Stopa szlifierska do narzędzia wielofunkcyjnego
 DE Schleifplatte für Multifunktionswerkzeug
 RU Шлифовальная бумага для многофункционального инструмента
 CZ Brusný nástavec pro multifunkční nářadí
 HU Csiszoló talp multifunkciós szerszámhoz
 RO Picior de sablare pt. unealta multifuncțională
 FR Plateau de ponçage pour outil multifonction
 IT Tasso di smerigliatrice multifunzionale
 ES Pie de rectificación para herramienta multifuncional
 CN 抛光盘

80 mm

AI



For YT-82223
 Dla YT-82223

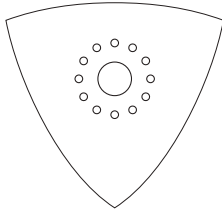

80 mm

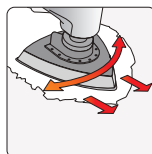

• Application: wood, metal, plaster
 • Zastosowanie: drewno, metal, gips

YATO  
YT-34692 10/100

EN Triangular sand paper for oscillating multitool
 PL Papier ścierny do narzędzia wielofunkcyjnego
 DE Schleifpapier für Multifunktionswerkzeug
 RU Шлифовальная бумага для многофункционального инструмента
 CZ Brusné plátno pro multifunkční nářadí
 HU Csiszolópapír multifunkciós szerszámhoz
 RO Hârtie abrazivă pt. unealta multifuncțională
 FR Feuilles abrasives pour outil multifonction
 IT Carta abrasiva per utensile multifunzione
 ES Papel de lija para herramienta multifuncional
 CN 抛光拉绒砂盘

10 PCS

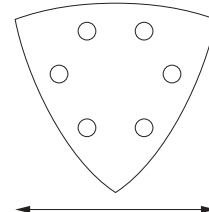

90 mm

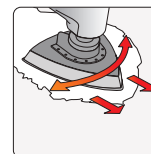

• Application: wood, metal, plaster
 • Zastosowanie: drewno, metal, gips

For YT-82220, YT-82223, YT-82818, YT-82900
 Dla YT-82220, YT-82223, YT-82818, YT-82900

YATO  
YT-34690 10/100

EN Triangular sand paper for oscillating multitool
 PL Papier ścierny do narzędzia wielofunkcyjnego
 DE Schleifpapier für Multifunktionswerkzeug
 RU Шлифовальная бумага для многофункционального инструмента
 CZ Brusné plátno pro multifunkční nářadí
 HU Csiszolópapír multifunkciós szerszámhoz
 RO Hârtie abrazivă pt. unealta multifuncțională
 FR Feuilles abrasives pour outil multifonction
 IT Carta abrasiva per utensile multifunzione
 ES Papel de lija para herramienta multifuncional
 CN 抛光拉绒砂盘

20 PCS

80 mm

P80

P120

P240

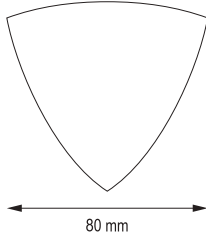

80 mm

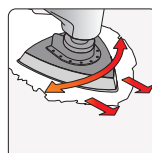
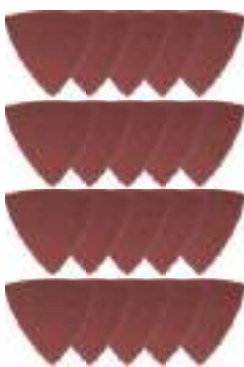

• Application: wood, metal, plaster
 • Zastosowanie: drewno, metal, gips

For YT-82220, YT-82223, YT-82818, YT-82900
 Dla YT-82220, YT-82223, YT-82818, YT-82900
 P80 (10 PCS), P120 (5 PCS), P240 (5 PCS)

YATO  
YT-34693 5/50

EN Accessories set for oscillating multitool
 PL Zestaw akcesoriów do narzędzia wielofunkcyjnego
 DE Zubehörsatz für Multifunktionswerkzeug
 RU Набор принадлежностей для многофункционального инструмента
 CZ Souprava příslušenství pro multifunkční nářadí
 HU Tartozék szett multifunkciós szerszámhoz
 RO Set de accesorii pt. unealta multifuncțională
 FR Set d'accessoires pour outil multifonction
 IT Set di accessori per utensile multifunzione
 ES Juego de accesorios para herramienta multifuncional
 CN 锯片附件

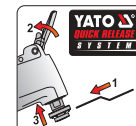

3 PCS

HSS

HCS

BIM

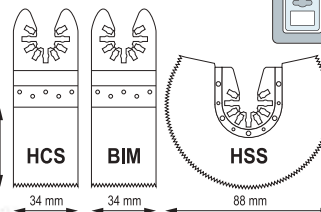

40 mm

34 mm

34 mm

88 mm



• Application: wood, plastic, metal, plaster, epoxy resin
 • Zastosowanie: drewno, plastik, metal, gips, żywica epoksydowa

For YT-82220, YT-82223, YT-82818, YT-82900
 Dla YT-82220, YT-82223, YT-82818, YT-82900

YATO  
YT-34691 10/100

- EN Tube wire brush
PL Szczotka druciana cylindryczna
DE Zylinder-Drahtbürste
RU Шетка-ерш для чистки труб
CZ Kartáč na trubky
HU Tisztító belső kefe
- RO Perie sarma de curatat tevi
FR Brosse cylindrique pour tubes en fil d'acier ondulé
IT Spazzola metallica a cilindro
ES Cepillos en espiral para tubos
CN 试管刷



YATO	Dimensions / Wymiary [mm]	
YT-47695	20x65x200	10/80
YT-47696	26x65x200	10/80
YT-47697	32x65x200	10/80
YT-47698	38x65x200	10/80

- EN Steel wire brush
PL Szczotka druciana
DE Stahldrahtbürste
- RU Щетка стальная
CZ Drátěný kartáč
HU Drótkefe
- RO Perie de sármă
FR Brosse de fil en laiton
IT Spazzola metallica
- ES Cepillo de acero
CN 塑料钢丝刷



YATO	Row quantity / Liczba rzędów	
YT-6353	3	12/120
YT-6354	4	12/120
YT-6355	5	12/120
YT-6356	6	12/120

YATO	Row quantity / Liczba rzędów	
YT-6358	4	12/72
YT-6359	5	12/72
YT-6360	6	12/72

- EN Steel wire brush
PL Szczotka druciana
DE Stahldrahtbürste
RU Щетка стальная
CZ Drátěný kartáč
CN 钢丝刷
- RO Perie de sármă
FR Brosse de fil en laiton
IT Spazzola metallica
ES Cepillo de acero
CN 钢丝刷



YATO	Row quantity / Liczba rzędów	L [mm]	
YT-6330	3	340	12/72

YATO	Row quantity / Liczba rzędów	L [mm]	
YT-6331	3	340	12/72



YATO	Row quantity / Liczba rzędów	L [mm]	
YT-6332	4	260	12/72

YATO	Row quantity / Liczba rzędów	L [mm]	
YT-6333	4	290	12/72

YATO	Row quantity / Liczba rzędów	Size / Rozmiar [mm]	
YT-6334	6	180x65	12/60



YATO	Row quantity / Liczba rzędów	L [mm]	
YT-6335	3	340	12/72

YATO	Row quantity / Liczba rzędów	L [mm]	
YT-6336	3	340	12/72

YATO	Row quantity / Liczba rzędów	L [mm]	
YT-6337	3	180	24/144



YATO	Row quantity / Liczba rzędów	L [mm]	
YT-6338	4	260	12/72

YATO	Row quantity / Liczba rzędów	L [mm]	
YT-6339	4	290	12/72

YATO	Row quantity / Liczba rzędów	L [mm]	
YT-6340	5	180	24/120



YATO	Row quantity / Liczba rzędów	L [mm]	
YT-6341	3	340	12/72

YATO	Row quantity / Liczba rzędów	L [mm]	
YT-6343	3	180	24/144

YATO	Row quantity / Liczba rzędów	L [mm]	
YT-6344	4	260	12/72



YATO	Row quantity / Liczba rzędów	L [mm]	
YT-6345	4	290	12/72

YATO	Row quantity / Liczba rzędów	L [mm]	
YT-6346	5	180	24/120

YATO	Row quantity / Liczba rzędów	L [mm]	
YT-6349	5	180	24/120

- EN Plastic handle wire brush set
PL Komplet szczotek drucianych
DE Bürstensatz
RU Набор стальных щеток
CZ Drátěný kartáč
HU Kefekészlet
RO Set perii de sarma
FR Set de brosses de fil en laiton
IT Set di spazzole metalliche
ES Juego de cepillos
CN 刷子组套



YATO	Row quantity / Liczba rzędów	L [mm]	
YT-6351	3	180	24/144

EN Cup brush with shaft
 PL Szczotka czolowa z trzpieniem
 DE Stahldraht-Topfbürste
 RU Щетка "чашка" со стержнем
 CZ Čelní kartáč drátěný se stopkou
 HU Homlok drótkefe, nyéllél
 RO Perie frontală pt. bormasina
 FR Brosse coupe avec goupille
 IT Spazzola a tazza
 ES Cepillo de copa con mandril
 CN 钢丝轮



YATO	Ø [mm]	max c [min ⁻¹]	
YT-4750	75	4500	12/96

EN Cup brush with shaft
 PL Szczotka czolowa z trzpieniem
 DE Stahldraht-Topfbürste
 RU Щетка "чашка" со стержнем
 CZ Čelní kartáč drátěný se stopkou
 HU Homlok drótkefe, nyéllél
 RO Perie frontală pt. bormasina
 FR Brosse coupe avec goupille
 IT Spazzola a tazza
 ES Cepillo de copa con mandril
 CN 钢丝轮



YATO	Ø [mm]	max c [min ⁻¹]	
YT-4751	75	4500	12/96

EN Cup brush with shaft
 PL Szczotka czolowa z trzpieniem
 DE Stahldraht-Topfbürste
 RU Щетка "чашка" со стержнем
 CZ Čelní kartáč drátěný se stopkou
 HU Homlok drótkefe, nyéllél
 RO Perie frontală pt. bormasina
 FR Brosse coupe avec goupille
 IT Spazzola a tazza
 ES Cepillo de copa con mandril
 CN 钢丝轮



YATO	Ø [mm]	max c [min ⁻¹]	
YT-4752	75	6000	12/72

EN Cup brush with shaft
 PL Szczotka czolowa z trzpieniem
 DE Stahldraht-Topfbürste
 RU Щетка "чашка" со стержнем
 CZ Čelní kartáč drátěný se stopkou
 HU Homlok drótkefe, nyéllél
 RO Perie frontală pt. bormasina
 FR Brosse coupe avec goupille
 IT Spazzola a tazza
 ES Cepillo de copa con mandril
 CN 带柄钢丝轮



YATO	Ø [mm]	max c [min ⁻¹]	
YT-47496	25	4500	20/240

EN Cup brush with shaft
 PL Szczotka czolowa z trzpieniem
 DE Stahldraht-Topfbürste
 RU Щетка "чашка" со стержнем
 CZ Čelní kartáč drátěný se stopkou
 HU Homlok drótkefe, nyéllél
 RO Perie frontală pt. bormasina
 FR Brosse coupe avec goupille
 IT Spazzola a tazza
 ES Cepillo de copa con mandril
 CN 带柄钢丝轮



YATO	Ø [mm]	max c [min ⁻¹]	
YT-47497	50	4500	12/144

EN Cup brush with shaft
 PL Szczotka czolowa z trzpieniem
 DE Stahldraht-Topfbürste
 RU Щетка "чашка" со стержнем
 CZ Čelní kartáč drátěný se stopkou
 HU Homlok drótkefe, nyéllél
 RO Perie frontală pt. bormasina
 FR Brosse coupe avec goupille
 IT Spazzola a tazza
 ES Cepillo de copa con mandril
 CN 带柄钢丝轮



YATO	Ø [mm]	max c [min ⁻¹]	
YT-47511	100	4500	6/36

EN Cup brush with shaft
 PL Szczotka czolowa z trzpieniem
 DE Stahldraht-Topfbürste
 RU Щетка "чашка" со стержнем
 CZ Čelní kartáč drátěný se stopkou
 HU Homlok drótkefe, nyéllél
 RO Perie frontală pt. bormasina
 FR Brosse coupe avec goupille
 IT Spazzola a tazza
 ES Cepillo de copa con mandril
 CN 带柄钢丝轮



YATO	Ø [mm]	max c [min ⁻¹]	
YT-47518	65	12500	10/100

EN Cup brush with shaft
 PL Szczotka czolowa z trzpieniem
 DE Stahldraht-Topfbürste
 RU Щетка "чашка" со стержнем
 CZ Čelní kartáč drátěný se stopkou
 HU Homlok drótkefe, nyéllél
 RO Perie frontală pt. bormasina
 FR Brosse coupe avec goupille
 IT Spazzola a tazza
 ES Cepillo de copa con mandril
 CN 带柄尼龙刷



YATO	Ø [mm]	max c [min ⁻¹]	
YT-47780	25	4500	20/240

EN Cup brush with shaft
 PL Szczotka czolowa z trzpieniem
 DE Stahldraht-Topfbürste
 RU Щетка "чашка" со стержнем
 CZ Čelní kartáč drátěný se stopkou
 HU Homlok drótkefe, nyéllél
 RO Perie frontală pt. bormasina
 FR Brosse coupe avec goupille
 IT Spazzola a tazza
 ES Cepillo de copa con mandril
 CN 带柄尼龙刷



YATO	Ø [mm]	max c [min ⁻¹]	
YT-47782	75	4500	10/120

EN Cup brush with shaft set
 PL Szczotki druciane z trzpieniem
 DE Drahtbürste mit Einspannschaft
 RU Щетки проволочные со стержнем
 CZ Drátěný kartáč se stopkou
 HU Drótkefe, csapos
 RO Perii de sârmă cu tijă
 FR Set de brosses coupe avec goupille
 IT Spazzola metallica a disco
 ES Cepillos de alambre con espiga
 CN 三件钢丝刷组套



YATO	Ø [mm]	max c [min ⁻¹]	
YT-4755	20, 50, 50	6000, 7500, 4500	12/60

EN Circular brush with shaft
PL Szczotka tarczowa z trzpieniem
DE Stahldraht-Scheibenbürste
RU Щетка круговая со стержнем
CZ Okružní kartáč drátěný se stopkou
HU Tarcás drótkefe, nyéllal
RO Perie rotunda pt. bormasina
FR Brosse circulaire avec goupille
IT Spazzola a disco
ES Cepillo redondo
CN 钢丝轮

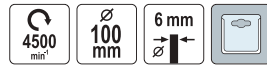

YATO 	Ø [mm]	max. c [min ⁻¹]	
YT-4757	100	4500	12/96

EN Circular brush with shaft
PL Szczotka tarczowa z trzpieniem
DE Stahldraht-Scheibenbürste
RU Щетка круговая со стержнем
CZ Okružní kartáč drátěný se stopkou
HU Tarcás drótkefe, nyéllal
RO Perie rotunda pt. bormasina
FR Brosse circulaire avec goupille
IT Spazzola a disco
ES Cepillo redondo
CN 钢丝轮



YATO 	Ø [mm]	max. c [min ⁻¹]	
YT-4758	100	4500	12/96

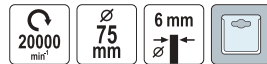

EN Circular brush with shaft
PL Szczotka tarczowa z trzpieniem
DE Stahldraht-Scheibenbürste
RU Щетка круговая со стержнем
CZ Okružní kartáč drátěný se stopkou
HU Tarcás drótkefe, nyéllal
RO Perie rotunda pt. bormasina
FR Brosse circulaire avec goupille
IT Spazzola a disco
ES Cepillo redondo
CN 钢丝轮



YATO 	Ø [mm]	max. c [min ⁻¹]	
YT-4759	75	20000	10/100



EN Circular brush with shaft
PL Szczotka tarczowa z trzpieniem
DE Stahldraht-Scheibenbürste
RU Щетка круговая со стержнем
CZ Okružní kartáč drátěný se stopkou
HU Tarcás drótkefe, nyéllal
RO Perie rotunda pt. bormasina
FR Brosse circulaire avec goupille
IT Spazzola a disco
ES Cepillo redondo
CN 钢丝轮



YATO 	Ø [mm]	max. c [min ⁻¹]	
YT-4756	50	4500	20/240
YT-4758	75	4500	12/144



EN Circular brush with shaft
PL Szczotka tarczowa z trzpieniem
DE Stahldraht-Scheibenbürste
RU Щетка круговая со стержнем
CZ Okružní kartáč drátěný se stopkou
HU Tarcás drótkefe, nyéllal
RO Perie rotunda pt. bormasina
FR Brosse circulaire avec goupille
IT Spazzola a disco
ES Cepillo redondo
CN 钢丝轮



YATO 	Ø [mm]	max. c [min ⁻¹]	
YT-47791	75	4500	10/120
YT-47792	100	4500	10/60

EN Circular brush with shaft
PL Szczotka tarczowa z trzpieniem
DE Stahldraht-Scheibenbürste
RU Щетка круговая со стержнем
CZ Okružní kartáč drátěný se stopkou
HU Tarcás drótkefe, nyéllal
RO Perie rotunda pt. bormasina
FR Brosse circulaire avec goupille
IT Spazzola a disco
ES Cepillo redondo
CN 钢丝轮



YATO 	Ø [mm]	max. c [min ⁻¹]	
YT-47800	50	4500	6/36
YT-47801	75	4500	6/36
YT-47802	100	4500	6/36

EN Cup brush with shaft set
PL Szczotki drucziane z trzpieniem
DE Drahtbürste mit Einspannschaft
RU Щетки проволочные со стержнем
CZ Drátěný kartáč se stopkou
HU Drótkefe, csapós
RO Perii de sârmă cu tijă
FR Set de brosses coupe avec goupille
IT Spazzola metallica a disco
ES Cepillos de alambre con espiga
CN 钢丝刷

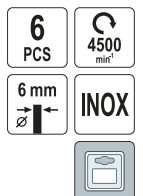

YATO 	Ø [mm]	max. c [min ⁻¹]	
YT-47593	37, 50, 62, 75	4500	6/60

EN Circular brush
 PL Szczotka tarczowa z gwintem
 DE Stahldraht-Scheibenbürste
 RU Щетка кырбоар
 CZ Okružní kartáč drátěný
 HU Tarcás drótkefe
 RO Perie rotunda pt. bormasina
 FR Brosse circulaire avec filet
 IT Spazzola conica
 ES Cepillo redondo
 CN 钢丝轮



YATO 	Ø [mm]	max. ω [min ⁻¹]	
YT-4761	100	12500	8/64

EN Circular brush
 PL Szczotka tarczowa z gwintem
 DE Stahldraht-Scheibenbürste
 RU Щетка кырбоар
 CZ Okružní kartáč drátěný
 HU Tarcás drótkefe
 RO Perie rotunda pt. bormasina
 FR Brosse circulaire avec filet
 IT Spazzola conica
 ES Cepillo redondo
 CN 钢丝轮



YATO 	Ø [mm]	max. ω [min ⁻¹]	
YT-4763	100	12500	8/64

EN Circular brush
 PL Szczotka tarczowa z gwintem
 DE Stahldraht-Scheibenbürste
 RU Щетка кырбоар
 CZ Okružní kartáč drátěný
 HU Tarcás drótkefe
 RO Perie rotunda pt. bormasina
 FR Brosse circulaire avec filet
 IT Spazzola conica
 ES Cepillo redondo
 CN 钢丝轮



YATO 	Ø [mm]	max. ω [min ⁻¹]	
YT-4764	125	10000	8/48

EN Circular brush
 PL Szczotka tarczowa z gwintem
 DE Stahldraht-Scheibenbürste
 RU Щетка кырбоар
 CZ Okružní kartáč drátěný
 HU Tarcás drótkefe
 RO Perie rotunda pt. bormasina
 FR Brosse circulaire avec filet
 IT Spazzola conica
 ES Cepillo redondo
 CN 钢丝轮



YATO 	Ø [mm]	max. ω [min ⁻¹]	
YT-47612	125	12500	10/60

EN Cup brush
 PL Szczotka czolowa z gwintem
 DE Stahldraht-Topfbürste
 RU Щетка "чашка"
 CZ Čelní kartáč drátěný
 HU Homlok drótkefe
 RO Perie frontală
 FR Brosse coupe avec filet
 IT Spazzola conica
 ES Cepillo de copa
 CN 钢丝轮



YATO 	Ø [mm]	max. ω [min ⁻¹]	
YT-4766	100	8500	4/32

EN Cup brush
 PL Szczotka czolowa z gwintem
 DE Stahldraht-Topfbürste
 RU Щетка "чашка"
 CZ Čelní kartáč drátěný
 HU Homlok drótkefe
 RO Perie frontală
 FR Brosse coupe avec filet
 IT Spazzola conica
 ES Cepillo de copa
 CN 钢丝轮



YATO 	Ø [mm]	max. ω [min ⁻¹]	
YT-4767	60	12500	10/80

EN Cup brush
 PL Szczotka czolowa z gwintem
 DE Stahldraht-Topfbürste
 RU Щетка "чашка"
 CZ Čelní kartáč drátěný
 HU Homlok drótkefe
 RO Perie frontală
 FR Brosse coupe avec filet
 IT Spazzola conica
 ES Cepillo de copa
 CN 钢丝轮



YATO 	Ø [mm]	max. ω [min ⁻¹]	
YT-4768	75	11000	6/36

EN Cup brush
 PL Szczotka czolowa z gwintem
 DE Stahldraht-Topfbürste
 RU Щетка "чашка"
 CZ Čelní kartáč drátěný
 HU Homlok drótkefe
 RO Perie frontală
 FR Brosse coupe avec filet
 IT Spazzola conica
 ES Cepillo de copa
 CN 钢丝轮



YATO 	Ø [mm]	max. ω [min ⁻¹]	
YT-4769	100	8500	4/16

EN Cup brush
PL Szczotka czolowa z gwintem
DE Stahldraht-Topfbürste
RU Щетка "чашка"
CZ Čelní kartáč drátěný
HU Homlok drótkefe
RO Perie frontală
FR Brosse coupe avec filet
IT Spazzola conica
ES Cepillo de copa
CN 钢丝轮



YATO	Ø [mm]	max c [min ⁻¹]	
YT-47691	125	6500	4/16

EN Cup brush
PL Szczotka czolowa z gwintem
DE Stahldraht-Topfbürste
RU Щетка "чашка"
CZ Čelní kartáč drátěný
HU Homlok drótkefe
RO Perie frontală
FR Brosse coupe avec filet
IT Spazzola conica
ES Cepillo de copa
CN 钢丝轮



YATO	Ø [mm]	max c [min ⁻¹]	
YT-47658	65	12500	10/80

EN Cup brush
PL Szczotka czolowa z gwintem
DE Stahldraht-Topfbürste
RU Щетка "чашка"
CZ Čelní kartáč drátěný
HU Homlok drótkefe
RO Perie frontală
FR Brosse coupe avec filet
IT Spazzola conica
ES Cepillo de copa
CN 尼龙刷



YATO	Ø [mm]	max c [min ⁻¹]	
YT-47785	65	12200	10/80
YT-47787	125	6500	6/24

EN Circular brush
PL Szczotka tarczowa z gwintem
DE Stahldraht-Scheibenbürste
RU Щетка круговая
CZ Okružní kartáč drátěný
HU Tarcásás drótkefe
RO Perie rotunda pt. bormasina
FR Brosse circulaire avec filet
IT Spazzola conica
ES Cepillo redondo
CN 带柄平行刷



YATO	Ø [mm]	max c [min ⁻¹]	
YT-47554	150x32	6000	5/40
YT-47555	200x32	4500	5/20

EN Drill powered scrub brushes
PL Zestaw szczotek na wiertarkę
DE Bürstensatz für Bohrmaschine
RU Набор щеток для дрели
CZ Sada uhliků do vrtačky
HU Kefekészlet fúróhoz
RO Set perii cu prindere
FR Ensemble de brosses pour perceuse
IT Set di spazzole per trapano
ES Juego de cepillos para taladro
CN 清洁刷

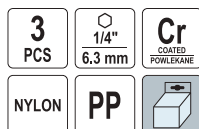

YATO	Ø [mm]	
YT-47553	50, 80, 100	40

EN Metal grinding disc
PL Tarcza do szlifowania metalu
DE Metall-Schleif-scheibe
RU Круги для шлифования по металлу
CZ Kotouč pro broušení kovu
HU Vágókorong fémez
RO Disc pt. șlefuit metal
FR Disque de polissage pour métaux
IT Disco per rettifica metallo
ES Disco cortador para metal
CN 研磨片



YATO	Ø [mm]	max c [min ⁻¹]	
YT-47820	125	12500	6/36

EN Drill powered scrub brushes
PL Zestaw szczotek na wiertarkę
DE Bürstensatz für Bohrmaschine
RU Набор щеток для дрели
CZ Sada uhliků do vrtačky
HU Kefekészlet fúróhoz
RO Set perii cu prindere
FR Ensemble de brosses pour perceuse
IT Set di spazzole per trapano
ES Juego de cepillos para taladro
CN 清洁刷

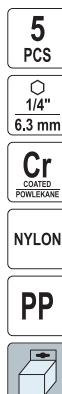

YATO	Ø [mm]	
YT-47777	5, 8, 10, 12 (x2)	24

EN Electrician's knife
 PL Nóż składany monterski
 DE Montagemesser
 RU Нож складной
 CZ Montážní nůž
 HU Szerelőkés
 RO Cuijit pt. decablat
 FR Couteau d'électricien
 IT Coltello
 ES Cuchillo de montaje
 CN 直刀电工刀

HRC 42-48 3Cr13

85/200 mm



75/190 mm



YATO L [mm]
 YT-7600 200 6/96

YATO L [mm]
 YT-7601 190 6/96

EN Folding knife with bits
 PL Nóż składany z bitami
 DE Klappmesser
 RU Нож складной
 CZ Kapesní nůž
 HU Zsebkés
 RO Briceag
 FR Couteau pince multifonction avec embouts
 IT Coltello pieghevole con punte
 ES Navaja
 CN 折叠刀

AI SS
 STAINLESS STEEL
 STAL NERDZEWA



3, 4 mm;
 PH1, PH2 mm;
 3, 4 mm;
 T10, T20

YATO
 YT-76031 6/48

EN Folding knife
 PL Nóż składany
 DE Klappmesser
 RU Нож складной
 CZ Kapesní nůž
 HU Zsebkés
 RO Briceag
 FR Couteau pliant
 IT Coltello pieghevole
 ES Navaja
 CN 带登山扣的折叠刀

SS
 STAINLESS STEEL
 STAL NERDZEWA



AI

YATO
 YT-76050 12/72



YATO
 YT-76051 12/120



YATO
 YT-76052 6/48

EN Multi knife
 PL Narzędzie wielofunkcyjne
 DE Klappmesser
 RU Нож складной
 CZ Kapesní nůž
 HU Zsebkés
 RO Briceag
 FR Couteau pince multifonction
 IT Pinza multifunzione
 ES Navaja
 CN 多功能折叠刀

9 PCS
 AI SS
 STAINLESS STEEL
 STAL NERDZEWA



YATO
 YT-76040 12/120

EN Multi knife
 PL Narzędzie wielofunkcyjne
 DE Klappmesser
 RU Нож складной
 CZ Kapesní nůž
 HU Zsebkés
 RO Briceag
 FR Couteau pince multifonction
 IT Pinza multifunzione
 ES Navaja
 CN 多功能折叠刀

9 PCS
 AI SS
 STAINLESS STEEL
 STAL NERDZEWA



YATO
 YT-76041 12/48

EN Multi knife
PL Narzędzie wielofunkcyjne
DE Klappmesser
RU Нож складной
CZ Kapesní nůž
HU Zsebkés
RO Briceag
FR Couteau pince multifonction
IT Pinza multifunzione
ES Navaja
CN 多功能折叠刀

9
PCS
SS
STAINLESS STEEL
STAL NIERDZEWNA
AI



YATO
YT-76042

12/48

EN Cutter knife
PL Nożyk z ostrzem trapezowym
DE Cuttermesser
RU Нож универсальный
CZ Univerzální nůž s lichoběžníkovou čepelí
HU Univerzális kés

RO Cuțit cu lamă trapezoidală retractabilă
FR Cutter à lame trapezoidale
IT Coltellino con lama trapezoidale
ES Cuchillo con hoja trapezoidal
CN 折叠实用刀

1+5
61x33x0.5
mm
SK5



YATO
YT-7532

Blade size / Rozmiar ostrza [mm]
61x33x0.5

12/72

EN Cutter knife
PL Nożyk z ostrzem trapezowym
DE Cuttermesser
RU Нож универсальный
CZ Univerzální nůž s lichoběžníkovou čepelí
HU Univerzális kés

RO Cuțit cu lamă trapezoidală retractabilă
FR Cutter à lame trapezoidale
IT Coltellino con lama trapezoidale
ES Cuchillo con hoja trapezoidal
CN 折叠实用刀

x3
61x33x0.5
mm
SK5



YATO
YT-7520

Blade size / Rozmiar ostrza [mm]
61x33x0.5

6/48

EN Utility knife
PL Nożyk z łamanym ostrzem
DE Abbrechklingen-Messer
RU Нож строительный
CZ Nůž ulamovací
HU Univerzális kés
RO Cuțit universal (cutter)
FR Cutter à lame sécable
IT Taglierino
ES Cuchillo de papelería
CN 美工刀

9
mm
1+2
ABS
TPR
AUTO
LOCK
BLOKADA
METAL
SLIDING BAR
METALOWA
PROWADNICA
SELF-LOADING
BLADES
SAMOŁADUJĄCE
OSTRZA
SK5

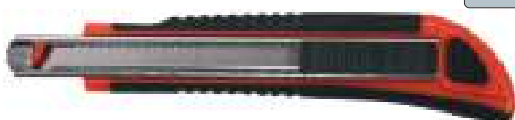

YATO
YT-75001

Blade size / Rozmiar ostrza [mm]
9x0.4

12/144

EN Utility knife
PL Nożyk z łamanym ostrzem
DE Abbrechklingen-Messer
RU Нож строительный
CZ Nůž ulamovací
HU Univerzális kés
RO Cuțit universal (cutter)
FR Cutter à lame sécable
IT Taglierino
ES Cuchillo de papelería
CN 美工刀

9
mm
AUTO
LOCK
BLOKADA
METAL
BODY
METALOWY
KORPUS
METAL
SLIDING BAR
METALOWA
PROWADNICA
SK2H



YATO
YT-75003

Blade size / Rozmiar ostrza [mm]
9x0.4

10/240

ULTRA SHARP

EN Multi knife
PL Narzędzie wielofunkcyjne
DE Klappmesser
RU Нож складной
CZ Kapesní nůž
HU Zsebkés
RO Briceag
FR Couteau pince multifonction
IT Pinza multifunzione
ES Navaja
CN 多功能折叠刀

9
PCS
SS
STAINLESS STEEL
STAL NIERDZEWNA



YATO
YT-76043

6/36

EN Cutter knife
PL Nożyk z ostrzem trapezowym
DE Cuttermesser
RU Нож универсальный
CZ Univerzální nůž s lichoběžníkovou čepelí
HU Univerzális kés

RO Cuțit cu lamă trapezoidală retractabilă
FR Cutter à lame trapezoidale
IT Coltellino con lama trapezoidale
ES Cuchillo con hoja trapezoidal
CN 折叠实用刀

x5
61x33x0.5
mm
150
mm
SK5



YATO
YT-7534

Blade size / Rozmiar ostrza [mm]
61x33x0.5

12/72

EN Cutter knife
PL Nożyk z ostrzem trapezowym
DE Cuttermesser
RU Нож универсальный
CZ Univerzální nůž s lichoběžníkovou čepelí
HU Univerzális kés

RO Cuțit cu lamă trapezoidală retractabilă
FR Cutter à lame trapezoidale
IT Coltellino con lama trapezoidale
ES Cuchillo con hoja trapezoidal
CN 折叠实用刀

1+3
61x33x0.5
mm
AUTO
RETRACTABLE
AUTOMATYCZNIE
WYSUWANIE
3
BLADE POSITIONS
POZYCJE OSTRZA
Zn
TPR
ABS
SK5



STRAP SIDE CUTTER
OBCINAK BOCZNY



YATO
YT-75201

Blade size / Rozmiar ostrza [mm]
61x33x0.5

12/72

EN Utility knife
PL Nożyk z łamanym ostrzem
DE Abbrechklingen-Messer
RU Нож строительный
CZ Nůž ulamovací
HU Univerzális kés
RO Cuțit universal (cutter)
FR Cutter à lame sécable
IT Taglierino
ES Cuchillo de papelería
CN 美工刀

9
mm
AUTO
LOCK
BLOKADA
METAL
SLIDING BAR
METALOWA
PROWADNICA
METAL
BODY
METALOWY
KORPUS
SK2H



YATO
YT-75002

Blade size / Rozmiar ostrza [mm]
9x0.4

10/240

ULTRA SHARP

EN Utility knife
PL Nożyk z łamanym ostrzem
DE Abbrechklingen-Messer
RU Нож строительный
CZ Nůž ulamovací
HU Univerzális kés
RO Cuțit universal (cutter)
FR Cutter à lame sécable
IT Taglierino
ES Cuchillo de papelería
CN 美工刀

18
mm
AUTO
LOCK
BLOKADA
METAL
SLIDING BAR
METALOWA
PROWADNICA
ABS
SK2H



YATO
YT-75123

Blade size / Rozmiar ostrza [mm]
18x0.5

10/120

ULTRA SHARP

EN Utility knife
 PL Nożyk z lamany ostrzem
 DE Abbrechklingen-Messer
 RU Нож строительный
 CZ Nůž ulamovací
 HU Univerzális kés
 RO Cuțit universal (cutter)
 FR Cutter à lame sécable
 IT Taglierino
 ES Cuchillo de papelería
 CN 美工刀

18 mm **SCREW LOCK BLOKADA ŚRUBOWA** **METAL SLIDING BAR METALOWA PROWADNICA** **ABS** **SK2H**



ULTRA SHARP

YATO	Blade size / Rozmiar ostrza [mm]	
YT-75124	18x0.5	10/120

EN Utility knife
 PL Nożyk z lamany ostrzem
 DE Abbrechklingen-Messer
 RU Нож строительный
 CZ Nůž ulamovací
 HU Univerzális kés
 RO Cuțit universal (cutter)
 FR Cutter à lame sécable
 IT Taglierino
 ES Cuchillo de papelería
 CN 美工刀

18 mm **max 20 kg** **AUTO LOCK BLOKADA** **METAL SLIDING BAR METALOWA PROWADNICA** **Zn TPR** **SK5**

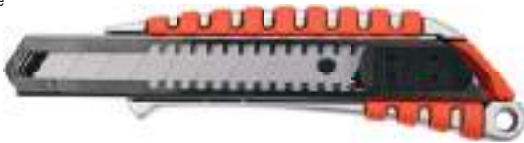

YATO	Blade size / Rozmiar ostrza [mm]	
YT-75122	18x0.5	12/144

EN Utility knife
 PL Nożyk z lamany ostrzem
 DE Abbrechklingen-Messer
 RU Нож строительный
 CZ Nůž ulamovací
 HU Univerzális kés
 RO Cuțit universal (cutter)
 FR Cutter à lame sécable
 IT Taglierino
 ES Cuchillo de papelería
 CN 美工刀

ABS TPR **LOCK BLOKADA** **SK2**



YATO	Blade size / Rozmiar ostrza [mm]	
YT-7506	9x0.4	24/240
YT-7507	18x0.5	12/144

EN Utility knife
 PL Nożyk z lamany ostrzem
 DE Abbrechklingen-Messer
 RU Нож строительный
 CZ Nůž ulamovací
 HU Univerzális kés
 RO Cuțit universal (cutter)
 FR Cutter à lame sécable
 IT Taglierino
 ES Cuchillo de papelería
 CN 美工刀

18 mm **max 20 kg** **AUTO LOCK BLOKADA** **METAL SLIDING BAR METALOWA PROWADNICA** **ABS TPR** **SK5**



YATO	Blade size / Rozmiar ostrza [mm]	
YT-75072	18x0.5	12/144

EN Utility knife
 PL Nożyk z lamany ostrzem
 DE Abbrechklingen-Messer
 RU Нож строительный
 CZ Nůž ulamovací
 HU Univerzális kés
 RO Cuțit universal (cutter)
 FR Cutter à lame sécable
 IT Taglierino
 ES Cuchillo de papelería
 CN 美工刀

25 mm **max 20 kg** **AUTO LOCK BLOKADA** **METAL SLIDING BAR METALOWA PROWADNICA** **ABS TPR** **SK5**

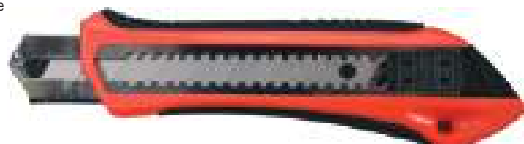

YATO	Blade size / Rozmiar ostrza [mm]	
YT-75101	25x0.7	12/144

EN Utility knife
 PL Nożyk z lamany ostrzem
 DE Abbrechklingen-Messer
 RU Нож строительный
 CZ Nůž ulamovací
 HU Univerzális kés
 RO Cuțit universal (cutter)
 FR Cutter à lame sécable
 IT Taglierino
 ES Cuchillo de papelería
 CN 美工刀

18 mm **max 20 kg** **AUTO LOCK BLOKADA** **METAL SLIDING BAR METALOWA PROWADNICA** **Zn TPR ABS** **SK5**



YATO	Blade size / Rozmiar ostrza [mm]	
YT-75121	18x0.5	12/144

EN Utility knife
 PL Nożyk z lamany ostrzem
 DE Abbrechklingen-Messer
 RU Нож строительный
 CZ Nůž ulamovací
 HU Univerzális kés
 RO Cuțit universal (cutter)
 FR Cutter à lame sécable
 IT Taglierino
 ES Cuchillo de papelería
 CN 美工刀

SK2



YATO	Blade size / Rozmiar ostrza [mm]	
YT-7511	9x0.4	24/288
YT-7512	18x0.5	12/96

EN Utility knife
 PL Nożyk z lamany ostrzem
 DE Abbrechklingen-Messer
 RU Нож строительный
 CZ Nůž ulamovací
 HU Univerzális kés
 RO Cuțit universal (cutter)
 FR Cutter à lame sécable
 IT Taglierino
 ES Cuchillo de papelería
 CN 美工刀

18 mm **max 20 kg** **AUTO LOCK BLOKADA** **METAL SLIDING BAR METALOWA PROWADNICA** **ABS TPR** **SK5**

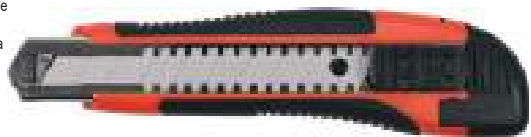

YATO	Blade size / Rozmiar ostrza [mm]	
YT-75071	18x0.5	12/144

EN Utility knife
 PL Nożyk z lamany ostrzem
 DE Abbrechklingen-Messer
 RU Нож строительный
 CZ Nůž ulamovací
 HU Univerzális kés

RO Cuțit universal (cutter)
 FR Cutter à lame sécable
 IT Taglierino
 ES Cuchillo de papelería
 CN 美工刀

ABS **SK2**



YATO	Blade size / Rozmiar ostrza [mm]	
YT-7504	9x0.4	24/240
YT-7505	18x0.5	24/240

EN Spare blades
 PL Ostrza zapasowe
 DE Abbrechklingen
 RU Лезвия для универсальных ножей
 CZ Lomené ostří náhradní
 HU Törhető tartalékpenge

RO Lame de rezervă rupte
 FR Lame sécables pour le cutter
 IT Lame di ricambio
 ES Filo partido de recambio
 CN 美工刀片

10 PCS **SK2H**



ULTRA SHARP

YATO	Blade size / Rozmiar ostrza [mm]	
YT-75260	9x0.4	10/240
YT-75261	18x0.5	10/120

EN Spare blades
PL Ostrza zapasowe
DE Abbrechklingen
RU Лезвия для универсальных ножей
CZ Lomené ostří náhradní
HU Törhető tartalékpenge

RO Lame de rezervă rupte
FR Lame sécables pour le cutter
IT Lame di ricambio
ES Filo partido de recambio
CN 美工刀片

10
PCS

SK5



YATO	Blade size / Rozmiar ostrza [mm]	
YT-7528	9x0.4	24/144
YT-7529	18x0.5	24/144
YT-7530	25x0.7	6/48

EN Spare blades
PL Ostrza zapasowe
DE Abbrechklingen
RU Лезвия для универсальных ножей
CZ Lomené ostří náhradní
HU Törhető tartalékpenge

RO Lame de rezervă rupte
FR Lame sécables pour le cutter
IT Lame di ricambio
ES Filo partido de recambio
CN 美工刀片

10
PCS

SK2



YATO	Blade size / Rozmiar ostrza [mm]	
YT-7524	9x0.4	24/240
YT-7525	18x0.5	24/144
YT-75262	25x0.7	10/60

EN Squeegee with felt for pressing the film
PL Rakiel do dociskania folii
DE Folienpressrakerel
RU Ракель для прижатия пленки
CZ Stěrka pro přitlačení fólie
HU Fólia kasírozó

RO Raclela colant
FR Racloir à feuilles
IT Raschietto per pellicola
ES Rasqueta para presionar película
CN 毛毡刮片

100x73
mm



YATO	Size / Rozmiar [mm]	
YT-52550	100x73	20/200

EN Glass oil cutter
PL Nóż olejowy do szkła
DE Glasschneider

RU Стеклопорец масляный
CZ Řezák na sklo
HU Olajkés üveghesz

RO Diamant pt. taiat sticla cu ulei
FR Coupe-verre à l'huile pour verre
IT Taglia vetro con serbatoio olio

ES Cuchillo de aceite para cristallisation
CN 玻璃割刀

HRA
92.5-93

YD05



177
mm

YATO	L [mm]	
YT-7560	177	12/120

EN Glass cutter with diamond tip
PL Nóż do cięcia szkła z końcówką diamentową
DE Glasschneider mit Diamantspitze
RU Стеклопорец с алмазным наконечником
CZ Nůž na sklo s diamentovou koncovkou
HU Üvegvágó kés gyémánt fejfel

RO Diamant sticla
FR Coupe-verre à pointe de diamant
IT Tagliavetro con punta di diamante
ES Cortador de vidrio con punta de diamante
CN 玻璃割刀

175
mm



YATO	L [mm]	
YT-37390	175	6/240

EN Spare blades
PL Ostrza zapasowe
DE Abbrechklingen
RU Лезвия для универсальных ножей
CZ Lomené ostří náhradní
HU Törhető tartalékpenge
RO Lame de rezervă rupte
FR Lame sécables pour le cutter
IT Lame di ricambio
ES Filo partido de recambio
CN 实用刀刀片

10
PCS

61x33
x0.5
mm

SK5



YATO	Blade size / Rozmiar ostrza [mm]	
YT-7531	61x33x0.5	24/144

EN Spare blades
PL Ostrza zapasowe
DE Abbrechklingen
RU Лезвия для универсальных ножей
CZ Lomené ostří náhradní
HU Törhető tartalékpenge
RO Lame de rezervă rupte
FR Lame sécables pour le cutter
IT Lame di ricambio
ES Filo partido de recambio
CN 实用刀刀片

10
PCS

61x33
x0.5
mm

SK2



YATO	Blade size / Rozmiar ostrza [mm]	
YT-7527	61x33x0.5	24/144

EN Scissors
PL Nożyczki
DE Haushaltsschere
RU Ножницы
CZ Nůžky
HU Olló

RO Foarfece
FR Ciseaux
IT Forbici
ES Tijeras
CN 剪刀

SS
STAINLESS STEEL
SZLA-MEDCERNIA



YATO	L [mm]	
YT-19763	170	12/120
YT-19764	190	12/120
YT-19765	215	12/120
YT-19766	245	12/120
YT-19767	300	12/120



178
mm

YATO	L [mm]	
YT-7561	178	12/120

EN 2-sided glass cutting tool
PL Dwustronny nóż do płytek ceramicznych i szkła
DE Doppelseitiger Fliesen- und Glasschneider
RU Двусторонний резак для керамической плитки и стекла
CZ Oboustranný nůž na keramické dlaždice a sklo
HU Kétoldalú csempé- és üvegvágó kés
RO Instrument de tăiat sticla cu 2 capete
FR Coupeur de carreaux et de verre à double face
IT Taglierina reversibile per piastrelle e vetro
ES Cuchillo doble para baldosas cerámicas y vidrio
CN 玻璃割刀

120
mm

2x
8mm

YG6X

1-2 SIDED
CUTTING
CUTTING
+ 2-STRONNE



YATO	L [mm]	
YT-37404	120	6/240

EN Glass cutter with 3 wheels
 PL Nóż do cięcia szkła z trzema kółkami
 DE Glasschneider mit drei Rädern
 RU Стеклоплез с тремя роликами
 CZ Nůž na sklo se třemi kolečky
 HU Üvegvágó kés három tárcsával

RO Diamant sticlă cu 3 cutite
 FR Coupe-verre à 3 molettes
 IT Tagliavetro a 3 ruote
 ES Cortador de vidrio con tres ruedas
 CN 玻璃割刀

130
mm

3x
YG6X



YATO	L [mm]	
YT-37391	130	10/150

EN Drywall board cutting tool with measuring tape
 PL Nóż do cięcia płyt gipsowo-kartonowych z miarą zwijaną
 DE Gipskartonschneider mit Rollmaß
 RU Нож для резы гипсокартона с рулеткой
 CZ Nůž na sádkarton se svinovacím metrem
 HU Mérőszalagos gipszkartonvágó kés
 RO Instrument de tăiat plăci de gips-carton cu bandă de măsurare
 FR Coupeur pour plaque de plâtre avec ruban-mètre intégré
 IT Taglierina per cartongesso con metro a nastro
 ES Cortador de placa de yeso con cinta métrica
 CN 石膏板切割器



5m
19mm

x5
BLADES
OUTRIZA



YATO		
YT-31350		30

EN Carving knife set
 PL Zestaw nożyków
 DE Klingensatz
 RU Набор резцов
 CZ Sada nožíků
 HU Késkészlet
 RO Set cutite prelucrare lemn
 FR Sculpture ensemble de couteau
 IT Set di coltelli
 ES Juego de cuchillas
 CN 美工刀

14 PCS HRC 60 T10 STEEL HANDLE AI MEKKI UCHWYT SOFT GRIP MIEKKI UCHWYT



YATO		
YT-75140		6/48

EN Carving knife set
 PL Zestaw nożyków
 DE Klingensatz
 RU Набор резцов
 CZ Sada nožíků
 HU Késkészlet
 RO Set cutite prelucrare lemn
 FR Sculpture ensemble de couteau
 IT Set di coltelli
 ES Juego de cuchillas
 CN 雕刻刀

16 PCS SK5



YATO		
YT-75370		4/24

EN Multifunction tool for drawing lines
 PL Przyrząd do trasowania linii równoległych
 DE Markierungswerkzeug für parallele Linien
 RU Устройство для разметки параллельных линий
 CZ Nástroj pro směřování rovnolehlých linií
 HU Párhuzamjelölő
 RO Instrument multifuncțional pt. desenarea liniilor
 FR Dispositif de marquage de lignes parallèles
 IT Strumento per disegnare linee parallele
 ES Trazador de arco lineal
 CN 木工划线器



SS STAINLESS STEEL AI

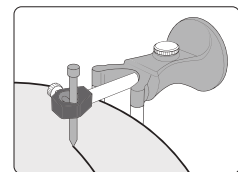

YATO		
YT-70730		20

EN Rotary cutter
 PL Nóż z okrągłym ostrzem
 DE Rollschneider
 RU Нож с круглым лезвием
 CZ Nůž s kulatým ostřím
 HU Körpengés kés

RO Cutter rotativ
 FR Couteau à lame ronde
 IT Coltello con lama circolare
 ES Cuchillo con filo redondo
 CN 割刀

45
mm

ABS
TPR

SK5

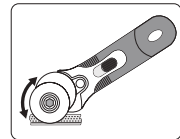

YATO		
YT-75360		12/96

EN Double edge trimmer
 PL Dwustronny nóż do odcinania oklein
 DE Kantentrimmer
 RU Двусторонний нож для мебельной пленки
 CZ Orezávací nůž na hrany lamina
 HU Kétélű vágó
 RO Rindea pt. finisaje
 FR Couteau réversible pour bois de placage
 IT Doppio coltello
 ES Cuchillo de doble filo para cortar chapas de madera
 CN 双边刨子



13-25
mm

1, 2-SIDED
CUTTING
EDGE

SK5



YATO		
YT-5710		6/48

EN Automatic center punch
 PL Punktak automatyczny
 DE Automatischer Kömer
 RU Автоматический кернер
 CZ Automatické důlkítkem
 HU Automatikus központ punci

RO Punctator automat
 FR Pointeau automatique
 IT Bulino automatico
 ES Centro automático punch
 CN 自动中心冲

125
mm



YATO	L [mm]	
YT-47160	125	12/72

EN Scriber for glass, ceramics and metal
 PL Rysik do szkła, ceramiki i metalu
 DE Reißnadel für Glas, Keramik und Metall
 RU Штихель для стекла, керамика и металла
 CZ Rýsovací jehla na sklo, keramiku a kov
 HU Karctű üveghöz, kerámiához és fémhez

RO Ac de trasat pt. sticlă, ceramică și metal
 FR Stylet verre, céramique et métal
 IT Penna di vetro ceramica metallo
 ES Trazador para vidrio, cerámica y metal
 CN 划线器

140
mm

YG6X



YATO		
YT-75140		6/48

YATO	L [mm]	
YT-3740	140	20/300

EN Adjustable automatic center punch
 PL Punktak automatyczny regulowany
 DE Automatischer Kömer mit regelbare Schlagkraft
 RU Регулируемое автоматическое кернер
 CZ Nastavitelné automatické důlkítkem
 HU Automatikus központ punci

RO Punctator ajustabil automat
 FR Pointeau automatique réglable
 IT Bulino automatico regolabile
 ES Ajustable centro automático punch
 CN 可调中心冲

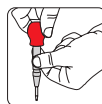

125
mm





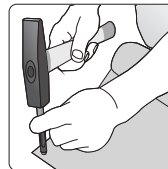

YATO	L [mm]	
YT-47161	125	12/72

EN Leather punch
PL Przebijak do skóry
DE Lederlocher
RU Кру́пный пробойник для кожи
CZ Průbojník na kůži
HU Bőrlyukasztó
RO Preducele
FR Perçoirs à cuir
IT Punteruolo per pelle
ES Perforar en piel
CN 皮带冲



YATO 	Ø [mm]	
YT-35850	2	20/100
YT-35851	3	20/100
YT-35852	4	20/100
YT-35853	5	20/100
YT-35854	6	20/100
YT-35855	7	20/100
YT-35856	8	20/100
YT-35857	9	20/100

YATO 	Ø [mm]	
YT-35858	10	20/100
YT-35859	11	20/100
YT-35860	12	20/100
YT-35861	13	20/100
YT-35862	14	20/100
YT-35863	15	20/100
YT-35864	16	20/100
YT-35865	17	20/100



YATO 	Ø [mm]	
YT-35866	18	20/100
YT-35867	19	20/80
YT-35868	20	20/80
YT-35869	21	20/60
YT-35870	22	20/80
YT-35871	23	10/50
YT-35872	24	20/60
YT-35873	25	20/60

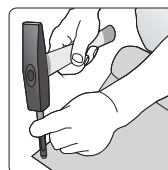

EN Punch set
PL Przebijaki do skóry
DE Lederlocher-set
RU Набор пробойников для кожи
CZ Sada průbojníků na kůži
HU Bőrlyukasztó készlet
RO Set preducele
FR Kit de perçoirs à cuir
IT Set di punzoni
ES Juego de perforar en piel
CN 皮带冲组套



3
PCS

4
PCS

YATO 	Ø [mm]	
YT-35881	6, 8, 10	20/120



YATO 	Ø [mm]	
YT-35880	2, 3, 4, 5	20/120

EN Punch set
PL Przebijaki do skóry
DE Lederlocher-set
RU Набор пробойников для кожи
CZ Sada průbojníků na kůži
HU Bőrlyukasztó készlet
RO Set preducele
FR Kit de perçoirs à cuir
IT Set di punzoni
ES Juego de perforar en piel
CN 冲孔器组套



9
PCS





YATO 	Ø [mm]	
YT-3590	2.5, 3, 4, 5, 6, 7, 8, 9, 10	50

EN Punch set
PL Przebijaki do skóry
DE Lederlocher-set
RU Набор пробойников для кожи
CZ Sada průbojníků na kůži
HU Bőrlyukasztó készlet
RO Set preducele
FR Kit de perçoirs à cuir
IT Set di punzoni
ES Juego de perforar en piel
CN 冲孔器组套



15
PCS



YATO 	Ø [mm]	
YT-3591	2, 2.5, 3.2, 4, 4.8, 5.5, 6.4, 8, 9.5, 11.1, 12.7, 14, 15.8, 19, 22	10

EN Window scraper CZ Škrabák na skla IT Cottellino con lama trapezoidale
 PL Skrobak do szyby HU Kaparó üveghez ES Rascador de cristales
 DE Fensterabstreicher RO Răzuitor pt. geamuri CN 玻璃刮刀
 RU Скребок для стекла FR Gratte-vitre



300 mm

390-600 mm

TELESCOPIC HANDLE
UCHWYT
TELESKOPOWY

AI

YATO	L [mm]	
YT-7550	300	10/60

YATO	L [mm]	
YT-7551	390-600	10/60

EN Floor scraper RU Скребок для полов RO Racleta pt. podea ES Rascador para suelos
 PL Skrobak do podłóg CZ Škrabka na podlahu FR Racloir à plancher CN 地板铲刀
 DE Bodenabstreifer HU Padlókaparó IT Raschietto per pavimenti



65Mn

AI



350 mm

Fitting blades: YT-52843
Pasujące ostrza: YT-52843

500 mm

Fitting blades: YT-52843
Pasujące ostrza: YT-52843

YATO	L [mm]	
YT-52840	350	6/12

YATO	L [mm]	
YT-52841	500	2/12

EN Spare blades RU Запасные лезвия RO Lame de rezerva ES Cuchillas de repuesto
 PL Ostrza zapasowe CZ Náhradní ostří FR Lames de rechange CN 刀片
 DE Ersatzklingen HU Pótkések IT Lame di ricambio

5 PCS



1.5 mm

65Mn



For YT-52840, YT-52841
Dla YT-52840, YT-52841

YATO	
YT-52843	10

EN Sliding hammer with scraper RO Ciocan inertial cu răzuitor
 PL Młot bezwładnościowy ze skrobakiem FR Impact grattoir
 DE Auswirkungen Schaber IT Martello inerziale con raschiatore
 RU Ударный скребок ES Raspador de impacto
 CZ Škrabka CN 冲击铲刀
 HU Kaparó eszköz



TELESCOPIC HANDLE
UCHWYT
TELESKOPOWY

T



YATO	L [mm]	
YT-52850	580-820	6

EN Scraper RU Цикля RO Răzuitor ES Raspador
 PL Cyklina CZ Škrabka na parkety FR Grattoir CN 油漆刮刀
 DE Ziehklinge HU Simitógyalu IT Raschietto per legno



YATO	L [mm]	Blade length / Długość ostrza [mm]	
YT-75460	260	52	10/60

YATO	L [mm]	Blade length / Długość ostrza [mm]	
YT-75461	290	62	12/48

YATO	L [mm]	Blade length / Długość ostrza [mm]	
YT-75464	200	30	10/50
YT-75465	220	40	10/50
YT-75467	270	65	6/24

- EN Prybar scraper set
PL Zestaw skrobaków ze stali nierdzewnej
DE Edelstahl-Schaber-Set
RU Набор скребков из нержавеющей стали
CZ Sada škrabek z nerezové oceli
HU Kaparókészlet rozsdamentes acélból
RO Set de raclete
FR Ensemble de racleurs en acier inoxydable
IT Set di raschietti in acciaio inox
ES Juego de raspadores de acero inoxidable
CN 铲刀

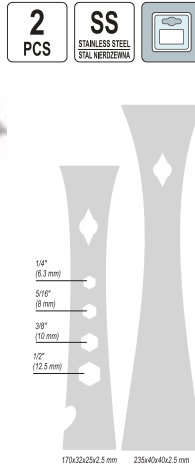

- EN Pry bar scraper set
PL Zestaw łomów i skrobaków
DE Brecheisen Schaber
RU Ломы скребки
CZ Škrabky páčidla
HU Feszítóvas kaparó
RO Set leviere
FR Pieds-de-biche et grattoirs
IT Piedi di porco raschietti
ES Palancas raspadores
CN 撬棍



YATO	[mm]	
YT-52860	170x32x25, 235x40x40	12/48

YATO	[mm]	
YT-52863	135x14, 182x25, 240x42	12/48

- EN Cabinet scraper set
PL Zestaw skrobaków ręcznych nierdzewnych
DE Edelstahl-Handschaber-Set
RU Набор ручных нержавеющей скребков
CZ Sada nerezových ručních škrabek
HU Kézi rozsdamentes kaparókészlet
RO Set raclete
FR Ensemble de grattoirs à main en acier inoxydable
IT Set di raschietti manuali inox
ES Juego de raspadores manuales inoxidables
CN 刮板



YATO	[mm]	
YT-52788	100x160, 120x80, 160x100, 205x98	20/40

- EN Block plane
PL Metalowy strug do drewna
DE Metallhobel für Holz
RU Металлический рубанок по дереву
CZ Kovový hoblík do dřeva
HU Fémgyaly
RO Rindea
FR Rabot à bois en métal
IT Pialla metallica per legno
ES Cepillo metálico para madera
CN 木工铁刨



YATO	Blade width / Szerokość ostrza [mm]	L [mm]	
YT-62900	44	235	24

- EN Block plane with two blade
PL Metalowy strug dwuostrzowy
DE Metallhobel mit Doppelreisen
RU Металлический рубанок с обоюдоострым лезвием
CZ Kovový hoblík s dvojitým ostřím
HU Kétpengés fémgyaly
RO Rindea cu 2 lame
FR Rabot en métal à deux lames
IT Pialla metallica a due lame
ES Cepillo metálico de doble hoja
CN 墙刨刨



YATO	Blade width / Szerokość ostrza [mm]	L [mm]	
YT-62907	23	235	12/48

- EN Chamfering planer
PL Strug do fazowania krawędzi
DE Kantenhobel
RU Рубанок для снятия фаски
CZ Nástroj na srážení hran
HU Letörési vágógép
RO Rindea pt. tesire
FR Rabot à chanfreiner
IT Pialla per smusso
ES Cepillo para biselar bordes
CN 倒角刨

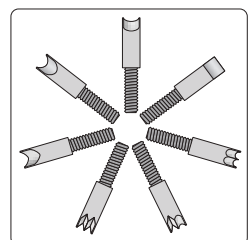

YATO	Blade width / Szerokość ostrza [mm]	L [mm]	
YT-62910	9	155	24

EN Steel file
 PL Piłnik do metalu
 DE Werkstatt-Feile
 RU Напильник слесарный
 CZ Zámeňický pilník
 HU Lakatos reszelő
 RO Pliă de lăcătușerie
 FR Lime à métal
 IT Lime per metallo
 ES Lima para metal
 CN 扁锉

#1 #2 #3 150 mm 200 mm 250 mm 300 mm T12



YATO	[#]	L [mm]	
YT-62228	1	150	20/80
YT-62229	1	200	20/80
YT-6223	1	250	20/80
YT-62231	1	300	10/40
YT-6180	2	150	20/80
YT-6185	2	200	20/80
YT-6228	2	250	20/80
YT-6190	2	300	10/40
YT-62328	3	150	20/80
YT-62329	3	200	20/80
YT-6233	3	250	20/80
YT-62331	3	300	10/40

YATO	[#]	L [mm]	
YT-62238	1	150	20/80
YT-62239	1	200	20/80
YT-6224	1	250	20/80
YT-62241	1	300	10/40
YT-6181	2	150	20/80
YT-6186	2	200	20/80
YT-6229	2	250	20/80
YT-6191	2	300	10/40
YT-62243	3	150	20/80
YT-62244	3	200	20/80
YT-62245	3	250	20/80
YT-62246	3	300	10/40



YATO	[#]	L [mm]	
YT-62248	1	150	20/80
YT-62249	1	200	20/80
YT-6225	1	250	20/80
YT-62251	1	300	10/40
YT-6182	2	150	20/80
YT-6187	2	200	20/80
YT-6230	2	250	20/80
YT-6192	2	300	10/40
YT-62338	3	150	20/80
YT-62339	3	200	20/80
YT-6234	3	250	20/80
YT-62341	3	300	10/40

YATO	[#]	L [mm]	
YT-62258	1	150	20/80
YT-62259	1	200	20/80
YT-6226	1	250	20/80
YT-62261	1	300	10/40
YT-6183	2	150	20/80
YT-6188	2	200	20/80
YT-6231	2	250	20/80
YT-6193	2	300	10/40
YT-62348	3	150	20/80
YT-62349	3	200	20/80
YT-6235	3	250	20/80
YT-62351	3	300	10/40

YATO	[#]	L [mm]	
YT-62268	1	150	20/80
YT-62269	1	200	20/80
YT-6227	1	250	20/80
YT-62271	1	300	10/40
YT-6184	2	150	20/80
YT-6189	2	200	20/80
YT-6232	2	250	20/80
YT-6194	2	300	10/40
YT-62358	3	150	20/80
YT-62359	3	200	20/80
YT-6236	3	250	20/80

EN Steel file set
 PL Piłniki do metalu
 DE Werkstatt-Feilen
 RU Набор напильников слесарных
 CZ Zámeňické pilníky
 HU Lakatos reszelő
 RO Pile de lăcătușerie
 FR Set de limes à métal
 IT Lime per metallo
 ES Juego de limas para metal
 CN 钢锉组套

#1 #2 #3
 250 mm T12



3 PCS

5 PCS

5 PCS

YATO	[#]	
YT-6237	2	10/20

YATO	[#]	
YT-6238	1, 2	5/10

YATO	[#]	
YT-6239	3	5/10

EN Needle file set
PL Zestaw pilników iglaków
DE Nadelfeilsatz
RU Набор напильников надфили

CZ Sada jehlových pilníků
HU Tűreszelő készlet
RO Set pile conice
FR Set de limes

IT Set di lime e lime ad ago
ES Juego de limas de aguja
CN 什锦锉组套

6
PCS

GCr15



YATO	Working length / Długość robocza [mm]	[mm]	
YT-6160	65	3x140	50/200

YATO	Working length / Długość robocza [mm]	[mm]	
YT-6161	75	4x160	25/100

YATO	Working length / Długość robocza [mm]	[mm]	
YT-6162	85	5x180	25/100

EN Needle file set
PL Zestaw pilników iglaków
DE Nadelfeilsatz
RU Набор напильников надфили

CZ Sada jehlových pilníků
HU Tűreszelő készlet
RO Set pile conice
FR Set de limes

IT Set di lime e lime ad ago
ES Juego de limas de aguja
CN 什锦锉组套

10
PCS

GCr15

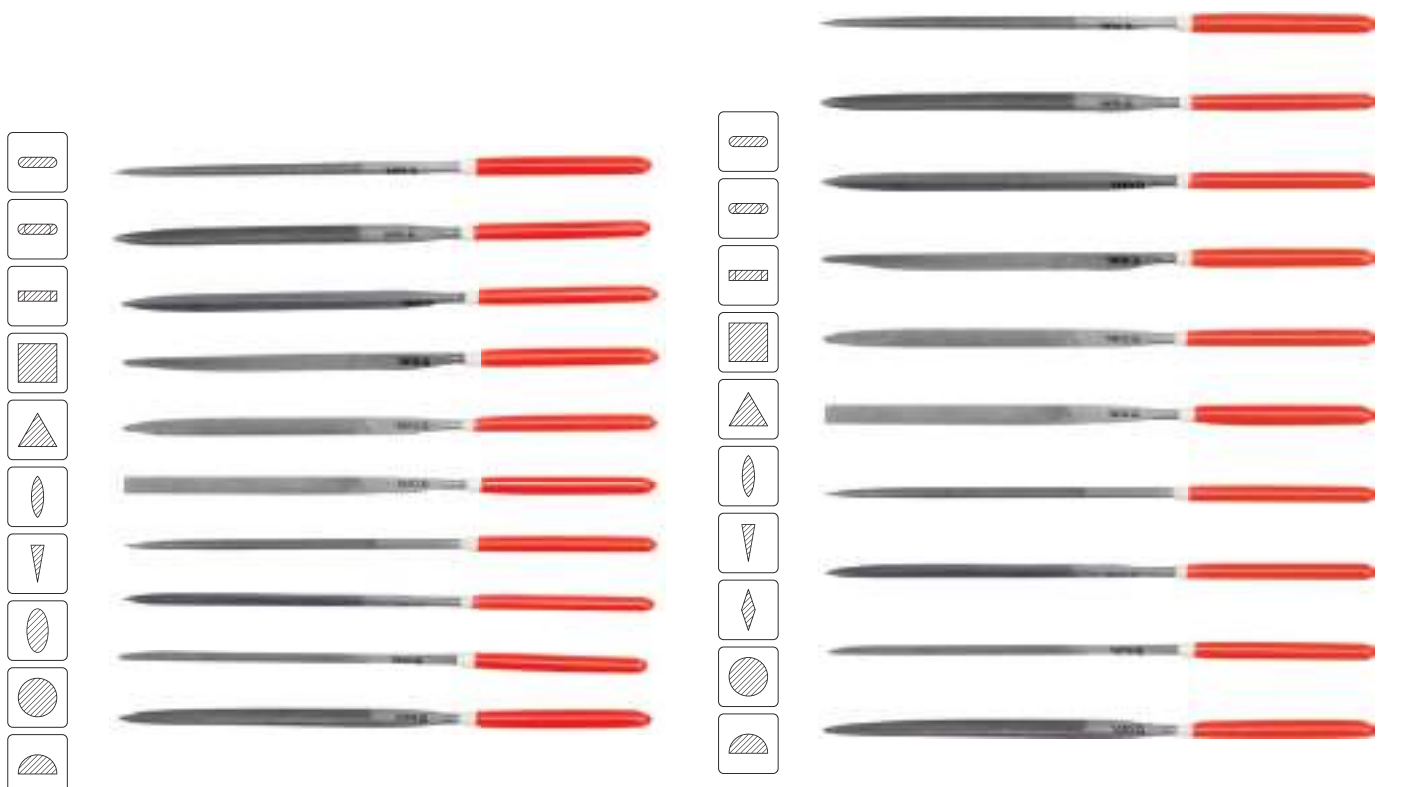

YATO	Working length / Długość robocza [mm]	[mm]	
YT-6163	65	3x140	25/100

YATO	Working length / Długość robocza [mm]	[mm]	
YT-6164	75	4x160	25/100
YT-6165	85	5x180	25/50

EN Diamond needle file
PL Pilnik iglak diamentowy
DE Diamant-Nadelfeile
RU Надфиль алмазный

CZ Diamantový jehlový pilník
HU Gyémánt tűreszelő
RO Pila diamantata
FR Lime diamant

IT Lime ad ago diamantate
ES Lima de aguja adiamantada
CN 金刚石平头扁锉

G150



YATO	Grit / Ziarnistość	Coating length / Długość nasypu [mm]	[mm]	
YT-6140	G150	52	3x140	120/1200
YT-6147	G150	50	4x160	80/800
YT-6152	G150	70	180	45/450

YATO	Grit / Ziarnistość	Coating length / Długość nasypu [mm]	[mm]	
YT-6141	G150	50	3x140	120/1200
YT-6148	G150	50	4x160	80/800
YT-6153	G150	70	5x180	45/450

YATO	Grit / Ziarnistość	Coating length / Długość nasypu [mm]	[mm]	
YT-6142	G150	50	3x140	120/1200
YT-6149	G150	50	4x160	80/800
YT-6154	G150	70	5x180	45/450

EN Diamond needle file set
 PL Zestaw pilników diamentowych igłoków
 DE Diamant-Nadelfeileinsatz
 RU Набор надфилей алмазных

CZ Sada diamentových jehlových pilníků
 HU Gyémánt tűreszelő készlet
 RO Set pile diamantate
 FR Set de limes diamant

IT Set lime ad ago diamantate
 ES Juego de limas de aguja adiamantadas
 CN 金刚石整形锉

G150

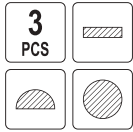
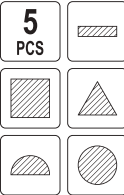

YATO	Grit / Ziarnistość	Coating length / Długość nasypu [mm]	[mm]	Box
YT-6143	G150	50	3x140	40/400
YT-6150	G150	50	4x160	30/300
YT-6155	G150	70	5x180	15/150

YATO	Grit / Ziarnistość	Coating length / Długość nasypu [mm]	[mm]	Box
YT-6156	G150	70	180	10/100

EN Diamond needle file set
 PL Zestaw pilników diamentowych igłoków
 DE Diamant-Nadelfeileinsatz
 RU Набор надфилей алмазных

CZ Sada diamentových jehlových pilníků
 HU Gyémánt tűreszelő készlet
 RO Set pile diamantate
 FR Set de limes diamant

IT Set lime ad ago diamantate
 ES Juego de limas de aguja adiamantadas
 CN 金刚石整形锉

10
PCS

G150

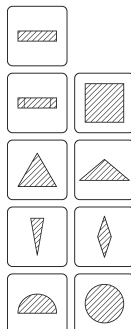

YATO	Grit / Ziarnistość	Coating length / Długość nasypu [mm]	[mm]	Box
YT-6144	G150	50	3x140	12/120

YATO	Grit / Ziarnistość	Coating length / Długość nasypu [mm]	[mm]	Box
YT-6145	G150	25	3x140	12/120

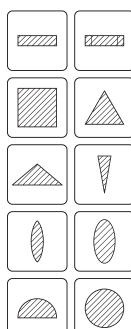

YATO	Grit / Ziarnistość	Coating length / Długość nasypu [mm]	[mm]	Box
YT-6146	G150	30	3x140	12/120

YATO	Grit / Ziarnistość	Coating length / Długość nasypu [mm]	[mm]	Box
YT-6151	G150	50	4x160	9/90

EN Diamond sharpening file
PL Osełka diamentowa - pilnik
DE Diamant-Schärfen-Datei
RU Напильник алмазный
CZ Diamantový pilník
HU Gyémánt reszelők

RO Pila diamentata pt. ascutit
FR Fichier de diamant
IT Pietra diamentata - lima
ES Archivo de afilado de diamante
CN 金刚石锉刀



YATO	Grit / Ziarnistość	L [mm]	
YT-76080	G240, G400	250	12/48

EN Diamond whetstone
PL Osełka diamentowa - blok
DE Diamant Schleifstein
RU Алмазный брусок
CZ Diamond brousek
HU Kétoldalal gyémánt fenőkő
RO Piatra abraziva diamentata
FR Affiloir diamanté
IT Pietra diamentata
ES Piedra de afilar diamentada
CN 金刚石磨刀石



YATO	Grit / Ziarnistość	Coating length / Długość nasypu [mm]	[mm]	
YT-76085	G300	50	4x150	10/60
YT-76086	G400	50	4x150	10/60
YT-76087	G600	50	4x150	10/60

EN Diamond grinding wheel dresser
PL Przyrząd diamentowy do wyrównywania tarcz szlifierskich
DE Diamant-Schleifrad-Dresser
RU Брусок алмазный для выравнивания абразивных дисков
CZ Diamantový ohrnovávač brusných kotoučů
HU Gyémánt köleghúzó
RO Diamant pt. rectific care pietre polizor
FR Diamant meule roue pierre dressé
IT Utensile diamentato per levigare le mole
ES Muelas locador con diamante plana
CN 砂轮修正器



YATO	
YT-61395	20/200

EN Wood rasp
PL Tarnik do drewna
DE Holzraspel
RU Рашпиля для дерева

CZ Rašple do dřeva
HU Fareszelő
RO Raspe
FR Lime à bois

IT Lime per legno
ES Escarpelo para madera
CN 木工挫 - 半圆



YATO	L [mm]		YATO	L [mm]		YATO	L [mm]	
YT-6220	250	12/72	YT-6219	250	12/72	YT-6221	250	12/72

EN Wood rasp set
PL Tarniki do drewna
DE Holzraspelsatz
RU Рашпили для дерева
CZ Sada rašplí do dřeva
HU Fareszelő készlet

RO Set raspe
FR Set de limes à bois
IT Set di lime per legno
ES Juego de escarpelos para madera
CN 木工挫组套

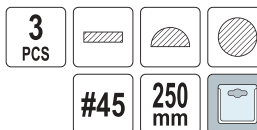

YATO	L [mm]	
YT-6222	250	5/20

EN Rasp for plaster
PL Tarnik do gipsu
DE Gipskartonplatten Rasp
RU Рашпиля для гипсокартона
CZ Rašple pro omítky
HU Reszelt vakolat
RO Rindea
FR Râpe pour plâtre
IT Raspa per gesso
ES Eliminador de yeso
CN 挫刨

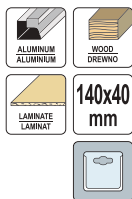

YATO	Working length / Długość robocza [mm]	Working width / Szerokość robocza [mm]	
YT-61678	140	40	15/60

EN Blade for rasp
PL Ostrze zapasowe do tarnika
DE Sägeblatttraspel
RU Лезвие для рашпиля по гипсокартону
CZ Čepel do škrabacích
HU Penge reszelő
RO Lama pt. rasp
FR Lame râpe
IT Lama di ricambio per raspa
ES Hoja para raspar
CN 挫刨刀片

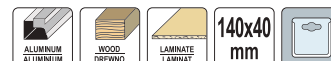

For YT-61678
Dla YT-61678

YATO	Working length / Długość robocza [mm]	Working width / Szerokość robocza [mm]	
YT-61679	140	40	10/120

EN Rasp for plaster
PL Tarnik do gipsu
DE Gipskartonplatten Rasp
RU Рашпили для гипсокартона
CZ Rašple pro omítky
HU Reszelt vakolat
RO Rindea
FR Râpe pour plâtre
IT Raspa per gesso
ES Eliminador de yeso
CN 挫刨

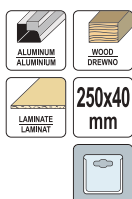

YATO	Working length / Długość robocza [mm]	Working width / Szerokość robocza [mm]	
YT-61680	250	40	15/60

EN Blade for rasp
PL Ostrze zapasowe do tarnika
DE Sägeblatttraspel
RU Лезвие для рашпиля по гипсокартону
CZ Čepel do škrabacích
HU Penge reszelő
RO Lama pt. rasp
FR Lame râpe
IT Lama di ricambio per raspa
ES Hoja para raspar
CN 挫刨刀片

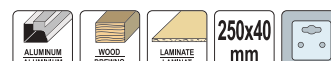

For YT-61680
Dla YT-61680

YATO	Working length / Długość robocza [mm]	Working width / Szerokość robocza [mm]	
YT-61681	250	40	30/120

EN Sand paper
 PL Papier ścierny
 DE Schleifpapier
 RU Наждачная бумага
 CZ Smirkový papír
 HU Csiszolópapír

RO Hârtie abrazivă
 FR Papier abrasif
 IT Carta vetrata
 ES Papel de lija
 CN 砂纸



- Application: paint, lacquer, filler, wood
- Abrasive: aluminium oxide
- Bond: synthetic resin
- Coating: semi-open
- Zastosowanie: farby, lakiery, szpachle, drewno
- Scierniwo: tlenek glinu
- Spoivo: żywica syntetyczna
- Nasyp: półotwarty

YATO	Grit / Ziarnistość	[mm]	pcs / szt.	
YT-8350	P40	230x280	50	500
YT-8351	P60	230x280	50	500
YT-8352	P80	230x280	50	500
YT-8353	P100	230x280	50	500
YT-8354	P120	230x280	50	500
YT-8355	P150	230x280	50	500
YT-8356	P180	230x280	50	500
YT-8357	P220	230x280	50	500
YT-8358	P240	230x280	50	500

EN Sand paper
 PL Papier ścierny
 DE Schleifpapier
 RU Наждачная бумага
 CZ Smirkový papír
 HU Csiszolópapír

RO Hârtie abrazivă
 FR Papier abrasif
 IT Carta vetrata
 ES Papel de lija
 CN 砂纸



- Application: paint, lacquer, filler, wood
- Abrasive: aluminium oxide
- Bond: synthetic resin
- Coating: semi-open
- Zastosowanie: farby, lakiery, szpachle, drewno
- Scierniwo: tlenek glinu
- Spoivo: żywica syntetyczna
- Nasyp: półotwarty

YATO	Grit / Ziarnistość	Size / Rozmiar	
YT-8441	P60	115 mm x 5 m	12/48
YT-8442	P80	115 mm x 5 m	12/48
YT-8443	P100	115 mm x 5 m	12/48
YT-8444	P120	115 mm x 5 m	12/48
YT-8445	P150	115 mm x 5 m	12/48
YT-8446	P180	115 mm x 5 m	12/48
YT-8447	P240	115 mm x 5 m	12/48
YT-8448	P320	115 mm x 5 m	12/48

EN Sand paper
 PL Papier ścierny
 DE Schleifpapier
 RU Наждачная бумага
 CZ Smirkový papír
 HU Csiszolópapír

RO Hârtie abrazivă
 FR Papier abrasif
 IT Carta vetrata
 ES Papel de lija
 CN 防水砂纸



- Application: paint, lacquer, filler
- Abrasive: silicon carbide
- Bond: synthetic resin
- Coating: closed
- Zastosowanie: farby, lakiery, szpachle
- Scierniwo: węgiel krzemowy
- Spoivo: żywica syntetyczna
- Nasyp: pełny

YATO	Grit / Ziarnistość	[mm]	pcs / szt.	
YT-8405	P180	230x280	50	500
YT-8406	P220	230x280	50	500
YT-8407	P240	230x280	50	500
YT-8408	P280	230x280	50	500
YT-8409	P320	230x280	50	500
YT-8410	P360	230x280	50	500
YT-8411	P400	230x280	50	500

EN Sand paper
 PL Papier ścierny
 DE Schleifpapier
 RU Наждачная бумага
 CZ Smirkový papír
 HU Csiszolópapír

RO Hârtie abrazivă
 FR Papier abrasif
 IT Carta vetrata
 ES Papel de lija
 CN 砂纸



- Application: paint, lacquer, filler, wood
- Abrasive: aluminium oxide
- Bond: synthetic resin
- Coating: semi-open
- Zastosowanie: farby, lakiery, szpachle, drewno
- Scierniwo: tlenek glinu
- Spoivo: żywica syntetyczna
- Nasyp: półotwarty

YATO	Grit / Ziarnistość	Size / Rozmiar	
YT-8449	P40	93 mm x 5 m	12/48
YT-8450	P60	93 mm x 5 m	12/48
YT-8451	P80	93 mm x 5 m	12/48
YT-8452	P100	93 mm x 5 m	12/48
YT-8453	P120	93 mm x 5 m	12/48
YT-8454	P150	93 mm x 5 m	12/48
YT-8455	P180	93 mm x 5 m	12/48
YT-8456	P240	93 mm x 5 m	12/48

EN Sand paper
 PL Papier ścierny
 DE Schleifpapier
 RU Наждачная бумага
 CZ Smirkový papír
 HU Csiszolópapír

RO Hârtie abrazivă
 FR Papier abrasif
 IT Carta vetrata
 ES Papel de lija
 CN 防水砂纸



- Application: paint, lacquer, filler
- Abrasive: silicon carbide
- Bond: synthetic resin
- Coating: closed
- Zastosowanie: farby, lakiery, szpachle
- Scierniwo: węgiel krzemowy
- Spoivo: żywica syntetyczna
- Nasyp: pełny

YATO	Grit / Ziarnistość	[mm]	pcs / szt.	
YT-8400	P60	230x280	50	500
YT-8401	P80	230x280	50	500
YT-8402	P100	230x280	50	500
YT-8403	P120	230x280	50	500
YT-8404	P150	230x280	50	500

EN Sand paper
 PL Papier ścierny
 DE Schleifpapier
 RU Наждачная бумага
 CZ Smirkový papír
 HU Csiszolópapír

RO Hârtie abrazivă
 FR Papier abrasif
 IT Carta vetrata
 ES Papel de lija
 CN 防水砂纸



- Application: paint, lacquer, filler
- Abrasive: silicon carbide
- Bond: synthetic resin
- Coating: closed
- Zastosowanie: farby, lakiery, szpachle
- Scierniwo: węgiel krzemowy
- Spoivo: żywica syntetyczna
- Nasyp: pełny

YATO	Grit / Ziarnistość	[mm]	pcs / szt.	
YT-8412	P500	230x280	50	500
YT-8413	P600	230x280	50	500
YT-8414	P800	230x280	50	500
YT-8415	P1000	230x280	50	500
YT-8416	P1200	230x280	50	500
YT-8417	P1500	230x280	50	500
YT-8418	P2000	230x280	50	500

EN Abrasive cloth sheet
PL Płótno ściernie arkusz
DE Schleifgewebe Blatt
RU Шлифовальное полотно
CZ Brusné plátno
HU Csiszolóvászon lap

RO Coli panza abraziva
FR Tissu abrasif
IT Carta vetrata
ES Hojas de pano abrasivo
CN 砂布



- Application: metal, wood
- Abrasive: aluminium oxide
- Bond: semi-resin
- Coating: closed
- Zastosowanie: metal, drewno
- Ścierniwo: tlenek glinu
- Spoiwo: żywica
- Nasyp pełny

YATO	Grit / Ziarnistość	[mm]	pcs / szt.	
YT-83160	P36	230x280	50	250
YT-83161	P40	230x280	50	250
YT-83162	P60	230x280	50	250
YT-83163	P80	230x280	50	250
YT-83164	P100	230x280	50	250
YT-83165	P120	230x280	50	500
YT-83166	P150	230x280	50	500
YT-83167	P180	230x280	50	500
YT-83168	P220	230x280	50	500
YT-83169	P240	230x280	50	500

EN Abrasive mesh
PL Siatka ścierna
DE Schleifgitter
RU Абразивная сетка
CZ Brusná sítko
HU Csiszolóháló

RO Plasă abrazivă
FR Disque abrasif à maille
IT Rete abrasiva
ES Malla abrasiva
CN 网状砂纸

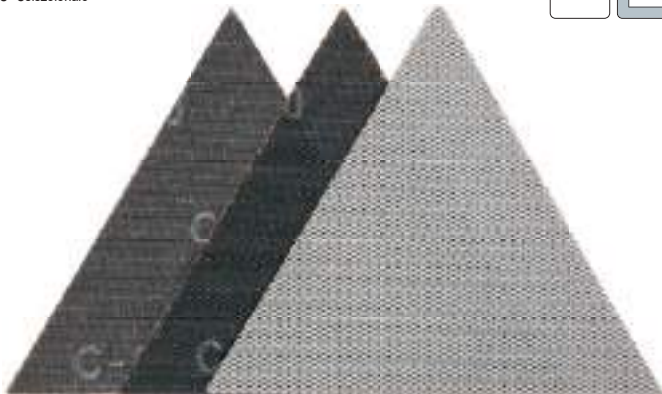

YATO	Grit / Ziarnistość	[mm]	pcs / szt.	
YT-846113	P80	280x280x280	3	100
YT-846133	P120	280x280x280	3	100
YT-846153	P180	280x280x280	3	100

EN Endless sanding belt
PL Taśma ścierna bezkońcowa
DE Schleifband
RU Шлифовальные ленты

CZ Brusný pás
HU Csiszoló szalag
RO Bandă de pânză
FR Bande abrasive sans fin

IT Nastro abrasivo senza fine
ES Pano abrasivo cinturón
CN 砂带



- Application: metal, wood
- Abrasive: aluminium oxide
- Bond: synthetic resin
- Coating: closed
- Zastosowanie: metal, drewno
- Ścierniwo: tlenek glinu
- Spoiwo: żywica syntetyczna
- Nasyp pełny

YATO	Grit / Ziarnistość	[mm]	pcs / szt.	
YT-09747	P60	20x520	10	50
YT-09748	P80	20x520	10	50
YT-09749	P100	20x520	10	50
YT-09750	P120	20x520	10	50

EN Abrasive cloth roll
PL Płótno ściernie rolka
DE Schleifgewebe Rolle
RU Рулон-шлифовальное полотно
CZ Brusné plátno role
HU Csiszolóvászon tekercs

RO Rola panza abraziva
FR Tissu abrasif rouleau
IT Carta vetrata rotolo
ES Rollo de pano abrasivo
CN 砂布



- Application: metal, wood
- Abrasive: aluminium oxide
- Bond: semi-resin
- Coating: closed
- Zastosowanie: metal, drewno
- Ścierniwo: tlenek glinu
- Spoiwo: żywica
- Nasyp pełny

YATO	Grit / Ziarnistość	Size / Rozmiar	
YT-83183	P60	150 mm x 50 m	2
YT-83184	P80	150 mm x 50 m	2
YT-83185	P100	150 mm x 50 m	2
YT-83186	P120	150 mm x 50 m	2
YT-83187	P150	150 mm x 50 m	2
YT-83188	P180	150 mm x 50 m	2

EN Endless sanding belt
PL Taśma ścierna bezkońcowa
DE Schleifband
RU Шлифовальные ленты
CZ Brusný pás
HU Csiszoló szalag

RO Bandă de pânză
FR Bande abrasive sans fin
IT Nastro abrasivo senza fine
ES Pano abrasivo cinturón
CN 砂带



- Application: metal, wood
- Abrasive: aluminium oxide
- Bond: synthetic resin
- Coating: closed
- Zastosowanie: metal, drewno
- Ścierniwo: tlenek glinu
- Spoiwo: żywica syntetyczna
- Nasyp pełny

YATO	Grit / Ziarnistość	[mm]	pcs / szt.	
YT-09743	P60	10x330	10	100
YT-09744	P80	10x330	10	100
YT-09745	P100	10x330	10	100
YT-09746	P120	10x330	10	100

EN No end abrasive band
PL Pas ścierny bezkońcowy
DE Schleifband
RU Шлифовальная бесконечная

CZ Brusný pás
HU Csiszoló szalag
RO Curea abraziva
FR Bande abrasive sans fin

IT Nastro abrasivo senza fine
ES Banda abrasiva sin fin
CN 砂带



- Application: metal, wood
- Abrasive: aluminium oxide
- Bond: synthetic resin
- Coating: closed
- Zastosowanie: metal, drewno
- Ścierniwo: tlenek glinu
- Spoiwo: żywica syntetyczna
- Nasyp pełny

YATO	Grit / Ziarnistość	[mm]	pcs / szt.	
YT-83221	P40	75x457	5	20/60
YT-83222	P60	75x457	5	20/60
YT-83223	P80	75x457	5	20/60
YT-83224	P100	75x457	5	20/60
YT-83225	P120	75x457	5	20/60

EN No end abrasive band
 PL Pas ścierny bezkońcowy
 DE Schleifband
 RU Шлифлента бесконечная

CZ Brusný pás
 HU Csiszoló szalag
 RO Curea abraziva
 FR Bande abrasive sans fin

IT Nastro abrasivo senza fine
 ES Banda abrasiva sin fin
 CN 砂带



- Application: metal, wood
- Abrasive: aluminium oxide
- Bond: synthetic resin
- Coating: closed
- Zastosowanie: metal, drewno
- Ścierniwo: tlenek glinu
- Spoiwo: żywica syntetyczna
- Nasyp pełny

YATO	Grit / Ziarnistość	[mm]	pcs / szt.	
YT-83227	P36	75x533	5	20/60
YT-83228	P40	75x533	5	20/60
YT-83229	P60	75x533	5	20/60
YT-83230	P80	75x533	5	20/60
YT-83231	P100	75x533	5	20/60
YT-83232	P120	75x533	5	20/60
YT-83233	P150	75x533	5	20/60

EN Sponge with diamond surface
 PL Gąbka z powierzchnią diamentową
 DE Diamant-Schleifschwamm
 RU Губка алмазная прямая
 CZ Diamantová houčička pro leštění
 HU Gyémánt felületű szivacs
 RO Burete cu suprafata diamantata
 FR Éponge à surface diamantée
 IT Spugnetta con superficie diamantata
 ES Esponja para lijar a mano de diamante
 CN 金刚石打磨块



YATO	Grit / Ziarnistość	
YT-76101	G60	50

EN Sponge with diamond surface
 PL Gąbka z powierzchnią diamentową
 DE Diamant-Schleifschwamm
 RU Губка алмазная прямая
 CZ Diamantová houčička pro leštění
 HU Gyémánt felületű szivacs
 RO Burete cu suprafata diamantata
 FR Éponge à surface diamantée
 IT Spugnetta con superficie diamantata
 ES Esponja para lijar a mano de diamante
 CN 金刚石打磨块



YATO	Grit / Ziarnistość	
YT-76105	G200	50

EN No end abrasive band
 PL Pas ścierny bezkońcowy
 DE Schleifband
 RU Шлифлента бесконечная

CZ Brusný pás
 HU Csiszoló szalag
 RO Curea abraziva
 FR Bande abrasive sans fin

IT Nastro abrasivo senza fine
 ES Banda abrasiva sin fin
 CN 砂带



- Application: metal, wood
- Abrasive: aluminium oxide
- Bond: synthetic resin
- Coating: closed
- Zastosowanie: metal, drewno
- Ścierniwo: tlenek glinu
- Spoiwo: żywica syntetyczna
- Nasyp pełny

YATO	Grit / Ziarnistość	[mm]	pcs / szt.	
YT-83235	P40	100x610	5	20/60
YT-83236	P60	100x610	5	20/60
YT-83237	P80	100x610	5	20/60
YT-83238	P100	100x610	5	20/60
YT-83239	P120	100x610	5	20/60

EN Sponge with diamond surface
 PL Gąbka z powierzchnią diamentową
 DE Diamant-Schleifschwamm
 RU Губка алмазная прямая
 CZ Diamantová houčička pro leštění
 HU Gyémánt felületű szivacs
 RO Burete cu suprafata diamantata
 FR Éponge à surface diamantée
 IT Spugnetta con superficie diamantata
 ES Esponja para lijar a mano de diamante
 CN 金刚石打磨块



YATO	Grit / Ziarnistość	
YT-76103	G100	50

EN Sponge with diamond surface
 PL Gąbka z powierzchnią diamentową
 DE Diamant-Schleifschwamm
 RU Губка алмазная прямая
 CZ Diamantová houčička pro leštění
 HU Gyémánt felületű szivacs
 RO Burete cu suprafata diamantata
 FR Éponge à surface diamantée
 IT Spugnetta con superficie diamantata
 ES Esponja para lijar a mano de diamante
 CN 金刚石打磨块



YATO	Grit / Ziarnistość	
YT-76108	G400	50

EN Flap disc – regular shape
PL Ściernica listkowa talerzowa płaska
DE Fächerschleifscheibe gerade
RU Круг лепестковый тарельчатый
CZ Lamelový brusný kotouč
HU Lamellás csiszoló normál
RO Disc lamelar frontal
FR Disque à lamelles abrasives plat
IT Disco abrasivo per metallo
ES Discos de paño abrasivo
CN 百叶轮



- Application: metal
- Abrasive: aluminium oxide
- Bond: synthetic resin
- Backing: fibreglass

- Zastosowanie: metal
- Ścierniwo: tlenek glinu
- Spoiwo: żywica syntetyczna
- Podkład: włókno szklane

YATO	Grit / Ziarnistość	Ø [mm]	Mounting hole diameter / Średnica mocowania [mm]	
YT-83271	P36	125	22.4	25/100
YT-83272	P40	125	22.4	25/100
YT-83273	P60	125	22.4	50/200
YT-83274	P80	125	22.4	50/200
YT-83275	P100	125	22.4	50/200
YT-83276	P120	125	22.4	50/200

EN Flap wheel with shaft
PL Ściernica listkowa trzpieniowa
DE Fächerschleifer mit Schaft
RU Круг лепестковый со шпинделем
CZ Lamelový kotouč s hřídelí
HU Legyező csiszoló csapos
RO Perie abraziva circulara cu tija
FR Disque à lamelles abrasives pivot
IT Ruote lamellari
ES Rueda laminar en tela abrasiva
CN 百叶轮



- Application: metal
 - Abrasive: aluminium oxide
 - Bond: synthetic resin
- Zastosowanie: metal
 - Ścierniwo: tlenek glinu
 - Spoiwo: żywica syntetyczna

YATO	Grit / Ziarnistość	[mm]	
YT-83351	P40	40x20x6	10/60
YT-83352	P60	40x20x6	10/60
YT-83353	P80	40x20x6	10/60
YT-83354	P100	40x20x6	10/60
YT-83355	P120	40x20x6	10/60
YT-83356	P150	40x20x6	10/60

EN Flap wheel with shaft
PL Ściernica listkowa trzpieniowa
DE Fächerschleifer mit Schaft
RU Круг лепестковый со шпинделем
CZ Lamelový kotouč s hřídelí
HU Legyező csiszoló csapos
RO Perie abraziva circulara cu tija
FR Disque à lamelles abrasives pivot
IT Ruote lamellari
ES Rueda laminar en tela abrasiva
CN 百叶轮



- Application: metal
 - Abrasive: aluminium oxide
 - Bond: synthetic resin
- Zastosowanie: metal
 - Ścierniwo: tlenek glinu
 - Spoiwo: żywica syntetyczna

YATO	Grit / Ziarnistość	[mm]	
YT-83371	P40	80x30x6	10/60
YT-83372	P60	80x30x6	10/60
YT-83373	P80	80x30x6	10/60
YT-83374	P100	80x30x6	10/60
YT-83375	P120	80x30x6	10/60
YT-83376	P150	80x30x6	10/60

EN Flap disc – depressed shape
PL Ściernica listkowa talerzowa wypukła
DE Fächerschleifscheibe gewölbt
RU Круг лепестковый тарельчатый
CZ Lamelový brusný kotouč - vypouklý
HU Lamellás csiszoló dőntött
RO Disc lamelar frontal depresat
FR Disque à lamelles abrasives bombé
IT Disco abrasivo a centro depresso
ES Discos de paño abrasivo centro embudido
CN 百叶轮



- Application: metal
- Abrasive: aluminium oxide
- Bond: synthetic resin
- Backing: fibreglass

- Zastosowanie: metal
- Ścierniwo: tlenek glinu
- Spoiwo: żywica syntetyczna
- Podkład: włókno szklane

YATO	Grit / Ziarnistość	Ø [mm]	Mounting hole diameter / Średnica mocowania [mm]	
YT-83291	P36	125	22.4	25/100
YT-83292	P40	125	22.4	25/100
YT-83293	P60	125	22.4	50/200
YT-83294	P80	125	22.4	50/200
YT-83295	P100	125	22.4	50/200
YT-83296	P120	125	22.4	50/200

EN Flap wheel with shaft
PL Ściernica listkowa trzpieniowa
DE Fächerschleifer mit Schaft
RU Круг лепестковый со шпинделем
CZ Lamelový kotouč s hřídelí
HU Legyező csiszoló csapos
RO Perie abraziva circulara cu tija
FR Disque à lamelles abrasives pivot
IT Ruote lamellari
ES Rueda laminar en tela abrasiva
CN 百叶轮



- Application: metal
 - Abrasive: aluminium oxide
 - Bond: synthetic resin
- Zastosowanie: metal
 - Ścierniwo: tlenek glinu
 - Spoiwo: żywica syntetyczna

YATO	Grit / Ziarnistość	[mm]	
YT-83361	P40	60x30x6	10/60
YT-83362	P60	60x30x6	10/60
YT-83363	P80	60x30x6	10/60
YT-83364	P100	60x30x6	10/60
YT-83365	P120	60x30x6	10/60
YT-83366	P150	60x30x6	10/60

EN Flap wheel with shaft
PL Ściernica listkowa trzpieniowa
DE Fächerschleifer mit Schaft
RU Круг лепестковый со шпинделем
CZ Lamelový kotouč s hřídelí
HU Legyező csiszoló csapos
RO Perie abraziva circulara cu tija
FR Disque à lamelles abrasives pivot
IT Ruote lamellari
ES Rueda laminar en tela abrasiva
CN 百叶轮



- Application: metal
 - Abrasive: aluminium oxide
 - Bond: synthetic resin
- Zastosowanie: metal
 - Ścierniwo: tlenek glinu
 - Spoiwo: żywica syntetyczna

YATO	Grit / Ziarnistość	[mm]	
YT-83381	P40	80x40x6	10/60
YT-83382	P60	80x40x6	10/60
YT-83383	P80	80x40x6	10/60
YT-83384	P100	80x40x6	10/60
YT-83385	P120	80x40x6	10/60
YT-83386	P150	80x40x6	10/60

EN Flap wheel with shaft
 PL Ściernica listkowa trzpieniowa
 DE Fächerschleifer mit Schaft
 RU Круг лепестковый со шпинделем
 CZ Lamelový kotouč s hřídelí
 HU Legyező csiszoló csapos
 RO Perie abraziva circulara cu tija
 FR Disque à lamelles abrasives pivot
 IT Ruote lamellari
 ES Rueda laminar en tela abrasiva
 CN 百叶轮



- Application: metal
- Abrasive: aluminium oxide
- Bond: synthetic resin
- Zastosowanie: metal
- Ścierniwo: tlenek glinu
- Spoivo: żywica syntetyczna

YATO	Grit / Ziarnistość	[mm]	
YT-83390	P60	50x30x6	10/60
YT-83391	P100	50x30x6	10/60
YT-83392	P150	50x30x6	10/60
YT-83393	P200	50x30x6	10/60

EN Flap wheel with shaft
 PL Ściernica listkowa trzpieniowa
 DE Fächerschleifer mit Schaft
 RU Круг лепестковый со шпинделем
 CZ Lamelový kotouč s hřídelí
 HU Legyező csiszoló csapos
 RO Perie abraziva circulara cu tija
 FR Disque à lamelles abrasives pivot
 IT Ruote lamellari
 ES Rueda laminar en tela abrasiva
 CN 百叶轮



- Application: metal
- Abrasive: aluminium oxide
- Bond: synthetic resin
- Zastosowanie: metal
- Ścierniwo: tlenek glinu
- Spoivo: żywica syntetyczna

YATO	Grit / Ziarnistość	[mm]	
YT-83394	P60	60x50x6	10/60
YT-83395	P100	60x50x6	10/60
YT-83396	P150	60x50x6	10/60
YT-83397	P200	60x50x6	10/60

EN Flap wheel with shaft
 PL Ściernica listkowa trzpieniowa
 DE Fächerschleifer mit Schaft
 RU Круг лепестковый со шпинделем
 CZ Lamelový kotouč s hřídelí
 HU Legyező csiszoló csapos
 RO Perie abraziva circulara cu tija
 FR Disque à lamelles abrasives pivot
 IT Ruote lamellari
 ES Rueda laminar en tela abrasiva
 CN 百叶轮



- Application: metal
- Abrasive: aluminium oxide
- Bond: synthetic resin
- Zastosowanie: metal
- Ścierniwo: tlenek glinu
- Spoivo: żywica syntetyczna

YATO	Grit / Ziarnistość	[mm]	
YT-83398	P60	80x50x6	10/60
YT-83399	P100	80x50x6	10/60
YT-83400	P150	80x50x6	10/60
YT-83401	P200	80x50x6	10/60

EN Abrasive mesh
 PL Siatka ścierna
 DE Schleifgitter
 RU Абразивная сетка
 CZ Brusný kotouč sítka
 HU Csiszolóháló
 RO Disc abraziv
 FR Disque abrasif à maille
 IT Rete abrasiva
 ES Malla abrasiva
 CN 网状砂纸



3 PCS
 Ø 225 mm

YATO	Grit / Ziarnistość	Ø [mm]	pcs / szt.	
YT-845803	P60	225	3	100
YT-845813	P80	225	3	100
YT-845823	P100	225	3	100
YT-845833	P120	225	3	100
YT-845843	P150	225	3	100
YT-845853	P180	225	3	100
YT-845863	P220	225	3	100

EN Abrasive disc
 PL Krążek ścierny
 DE Schleifblatt
 RU Круг шлифовальный
 CZ Brusný kotouč
 HU Csiszolóárcsa
 RO Disc abraziv
 FR Disques abrasifs avec velcro
 IT Disco abrasivo
 ES Juego de discos abrasivos
 CN 圆形砂纸



5 PCS
 HOOK FASTENER RZEP

- Application: metal, wood
- Abrasive: aluminium oxide
- Bond: synthetic resin
- Coating: semi-open
- Zastosowanie: metal, drewno
- Ścierniwo: tlenek glinu
- Spoivo: żywica syntetyczna
- Nasyp: półotwarty

YATO	Grit / Ziarnistość	Ø [mm]	
YT-83430	P36	125	50/200
YT-83431	P40	125	50/200
YT-83432	P60	125	50/200
YT-83433	P80	125	50/200
YT-83434	P100	125	50/200
YT-83435	P120	125	50/200
YT-83436	P150	125	50/200
YT-83437	P180	125	50/200
YT-83438	P220	125	50/200

EN Perforated abrasive disc
 PL Krążek ścierny perforowany
 DE Schleifscheibe, perforiert
 RU Перфорированный шлифовальный диск
 CZ Brusný kotouč perforovaný
 HU Perforált csiszolópapír
 RO Disc abraziv cu orificii
 FR Disque abrasif perforé
 IT Disco abrasivo perforato
 ES Muela abrasiva perforada
 CN 多孔砂纸

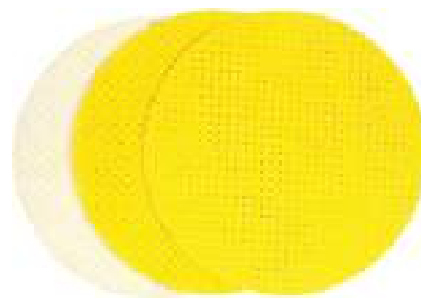

3 PCS
 Ø 225 mm
 PERFORATION PERFORACIA

YATO	Grit / Ziarnistość	Ø [mm]	pcs / szt.	
YT-846003	P60	225	3	33
YT-846013	P80	225	3	33
YT-846023	P100	225	3	33
YT-846033	P120	225	3	33
YT-846043	P150	225	3	33
YT-846053	P180	225	3	33
YT-846063	P220	225	3	33

EN Abrasive disc with holes
 PL Krążek ścierny z otworami
 DE Schleifscheibe mit Löchern
 RU Круг шлифовальный перфорированный
 CZ Brusný kotouč s otvory
 HU Csiszolókorong nyílásokkal
 RO Disc abraziv cu orificii
 FR Disques abrasifs avec trous
 IT Disco abrasivo con fori
 ES Disco abrasivo con orificios
 CN 圆形带孔砂纸

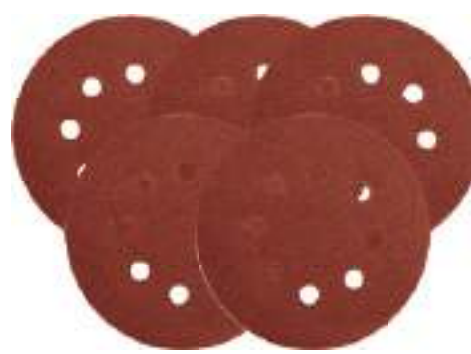

5 PCS
 HOOK FASTENER RZEP

- Application: metal, wood
- Abrasive: aluminium oxide
- Bond: synthetic resin
- Coating: semi-open
- Zastosowanie: metal, drewno
- Ścierniwo: tlenek glinu
- Spoivo: żywica syntetyczna
- Nasyp: półotwarty

YATO	Grit / Ziarnistość	Ø [mm]	
YT-83451	P40	125	50/200
YT-83452	P60	125	50/200
YT-83453	P80	125	50/200
YT-83454	P100	125	50/200
YT-83455	P120	125	50/200
YT-83456	P150	125	50/200
YT-83457	P180	125	50/200
YT-83458	P220	125	50/200

EN Abrasive disc with holes
PL Krążek ścierny z otworami
DE Schleifscheibe mit Löchern
RU Круг шлифовальный перфорированный
CZ Brsný kotouč s otvory
HU Csiszolókorong nyílásokkal
RO Disc abraziv cu orificii
FR Disque abrasif avec trous
IT Disco abrasivo con fori
ES Disco abrasivo con orificios
CN 圆形带孔砂纸

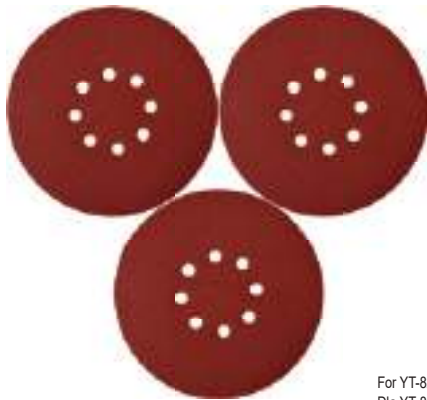

- Application: wood, plaster, paints
- Abrasive: aluminium oxide
- Bond: synthetic resin
- Coating: open
- Zastosowanie: drewno, gips, farby
- Ścierniwo: tlenek glinu
- Spoiwo: żywica syntetyczna
- Nasyt: otwarty

For YT-82341
Dla YT-82341

YATO	Grit / Ziarnistość	Ø [mm]	
YT-83460	P40	180	50/200
YT-83461	P60	180	50/200
YT-83462	P80	180	50/200
YT-83463	P100	180	50/200
YT-83464	P120	180	50/200
YT-83465	P150	180	50/200
YT-83466	P180	180	50/200
YT-83467	P240	180	50/200

EN Abrasive disc with holes
PL Krążek ścierny z otworami
DE Schleifscheibe mit Löchern
RU Круг шлифовальный перфорированный
CZ Brsný kotouč s otvory
HU Csiszolókorong nyílásokkal
RO Disc abraziv cu orificii
FR Disque abrasif avec trous
IT Disco abrasivo con fori
ES Disco abrasivo con orificios
CN 圆形带孔砂纸

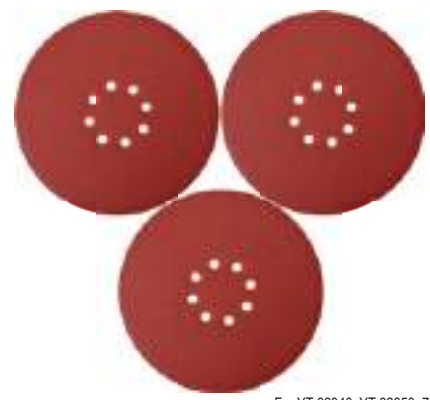

- Application: wood, plaster
- Abrasive: aluminium oxide
- Bond: synthetic resin
- Coating: semi-open
- Zastosowanie: drewno, gips
- Ścierniwo: tlenek glinu
- Spoiwo: żywica syntetyczna
- Nasyt: półotwarty

For YT-82340, YT-82350, 79307
Dla YT-82340, YT-82350, 79307

YATO	Grit / Ziarnistość	Ø [mm]	
YT-83471	P60	225	60/120
YT-83472	P80	225	60/120
YT-83473	P100	225	60/120
YT-83474	P120	225	60/120
YT-83475	P150	225	60/120
YT-83476	P180	225	60/120
YT-83477	P240	225	60/120

EN Abrasive disc with holes
PL Krążek ścierny z otworami
DE Schleifscheibe mit Löchern
RU Круг шлифовальный перфорированный
CZ Brsný kotouč s otvory
HU Csiszolókorong nyílásokkal
RO Disc abraziv cu orificii
FR Disque abrasif avec trous
IT Disco abrasivo con fori
ES Disco abrasivo con orificios
CN 圆形带孔砂纸



- Application: steel, wood, paints, lacquers
- Abrasive: aluminium oxide
- Bond: epoxy resin
- Coating: semi-open
- Zastosowanie: stal, drewno, farby, lakiery
- Ścierniwo: tlenek glinu
- Spoiwo: żywica epoksydowa
- Nasyt: półotwarty

For YT-09739, YT-09740
Dla YT-09739, YT-09740

YATO	Grit / Ziarnistość	Ø [mm]	
YT-834581	P40	150	20
YT-834582	P60	150	20
YT-834583	P80	150	20
YT-834584	P100	150	20
YT-834585	P120	150	20
YT-834586	P150	150	20
YT-834587	P180	150	20
YT-834588	P220	150	20
YT-834589	P240	150	20

EN Abrasive disc with holes
PL Krążek ścierny z otworami
DE Schleifscheibe mit Löchern
RU Круг шлифовальный перфорированный
CZ Brsný kotouč s otvory
HU Csiszolókorong nyílásokkal
RO Disc abraziv cu orificii
FR Disque abrasif avec trous
IT Disco abrasivo con fori
ES Disco abrasivo con orificios
CN 圆形带孔砂纸



- Application: steel, wood, paints, lacquers
- Abrasive: aluminium oxide
- Bond: epoxy resin
- Coating: semi-open
- Zastosowanie: stal, drewno, farby, lakiery
- Ścierniwo: tlenek glinu
- Spoiwo: żywica epoksydowa
- Nasyt: półotwarty

For YT-82206, YT-82207
Dla YT-82206, YT-82207

YATO	Grit / Ziarnistość	Ø [mm]	
YT-834591	P40	150	20
YT-834592	P60	150	20
YT-834593	P80	150	20
YT-834594	P100	150	20
YT-834595	P120	150	20
YT-834596	P150	150	20
YT-834597	P180	150	20
YT-834598	P220	150	20
YT-834599	P240	150	20

EN Abrasive sheet with holes
PL Arkusz ścierny z otworami
DE Schleifblatt mit Löchern
RU Шлифовальная перфорированная бумага для виброшлифмашинки
CZ Brsné archy z otvorami
HU Csiszoló lap lyukakkal
RO Coale (foi) abrazive cu orificii
FR Disques abrasifs trous avec velcro
IT Carta abrasiva con fori
ES Ojas abrasivas con agujeros
CN 砂纸



- Application: steel, wood, paints, filler
- Abrasive: aluminium oxide
- Bond: synthetic resin
- Coating: semi-open
- Zastosowanie: stal, drewno, farby, szpachle
- Ścierniwo: tlenek glinu
- Spoiwo: żywica syntetyczna
- Nasyt: półotwarty

For YT-82230
Dla YT-82230

YATO	Grit / Ziarnistość	[mm]	
YT-83800	P40	93x187	100/200
YT-83801	P60	93x187	100/200
YT-83802	P80	93x187	100/200
YT-83803	P100	93x187	100/200
YT-83804	P120	93x187	100/200
YT-83805	P150	93x187	100/200
YT-83806	P180	93x187	100/200
YT-83807	P220	93x187	100/200
YT-83808	P240	93x187	100/200

EN Back pad for drywall sander
 PL Wymienna głowica szlifierska dla szlifierki do gipsu
 DE Schleifkopf für Gips-Schleifmaschine abnehmbar
 RU Запасная шлифовальная головка для гипсовой шлифовальной машины
 CZ Náhradní brusná hlavice pro broušení sádry
 HU Cserélhető csiszolófej falcsiszoló géphez
 RO Disc pt. slefuitor pereti
 FR Tête de ponçage de rechange pour ponceuses à plâtre
 IT Testa rotonda sostituibile per smerigliatrice per gesso
 ES Cabeza de rectificado reemplazable para la rectificadora de yeso
 CN 圓磨盤



For / Dla: YT-82340, YT-82350
 Fitting sand papers / Pasujące papiery: YT-83470, YT-83471, YT-83472, YT-83473, YT-83474, YT-83475, YT-83476, YT-83477, YT-84600, YT-84601, YT-84602, YT-84603, YT-84604, YT-84605, YT-84606

YATO	Ø [mm]	
YT-82353	225	15/60

EN Hook and loop sanding pad
 PL Talerz polerski z rzepem
 DE Klett-Polierteller
 RU Диск с липучкой полировальный
 CZ Talíř se suchým zipem
 HU Tépőzáras tárcsa
 RO Disc de șlefuit cu scai
 FR Plateau avec velcro
 IT Platorello con velcro
 ES Plato de soporte con velcro
 CN 抛光盘



YATO	Ø [mm]	
YT-47870	75	200
YT-47872	125	150
YT-47873	150	100

EN Hook and loop polishing sponge
 PL Gąbka polerska na rzep
 DE Klett-Polierschwamm
 RU Губка для полировки с липучкой
 CZ Leštící houba na suchý zip
 HU Tépőzáras polírozó szivacs
 RO Burete de lustruit cu scai
 FR Éponge de polissage avec velcro
 IT Tampone in spugna con velcro
 ES Esponja de pulido con velcro
 CN 海绵抛光盘

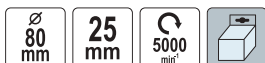

YATO	Sponge hardness / Twardość gąbki	
YT-47920	miękka	200
YT-47921	średnio twarda	200
YT-47922	twarda	200

EN Triangle back pad for drywall sander
 PL Wymienna trójkątna głowica dla szlifierki do gipsu
 DE Dreieck-Schleifkopf für Gips-Schleifmaschine abnehmbar
 RU Запасная треугольная головка для гипсовой шлифовальной машины
 CZ Vyměnitelná trojúhelníková hlavice pro broušení sádry
 HU Háromszög alakú cserélhető csiszolófej falcsiszoló géphez
 RO Disc triunghiular pt. slefuitor pereti
 FR Tête triangulaire de rechange pour ponceuse à plâtre
 IT Testa triangolare sostituibile per smerigliatrice per gesso
 ES Cabeza triangular reemplazable para la rectificadora de yeso
 CN 三角磨盤



For / Dla: YT-82350
 Fitting sand papers / Pasujące papiery: YT-84610, YT-84611, YT-84612, YT-84613, YT-84614, YT-84615, YT-84616

YATO	Dimensions / Wymiary [mm]	
YT-82354	280x280x280	20/60

EN Hook and loop backing pad
 PL Uchwyt mocujący z rzepem
 DE Klett-Haftstützteller
 RU Насадка шлифовальная под круг на липучке
 CZ Unašeč se suchým zipem
 HU Rögzőtárcsa tépőzáras
 RO Disc suport cu scai
 FR Plateau support avec velcro
 IT Platorello con velcro
 ES Plato para lijar y pulir con velcro
 CN 抛光盘



YATO	Ø [mm]	max. ω [min⁻¹]	
YT-47860	75	12000	200
YT-47890	125	5000	100

EN Hook and loop polishing sponge
 PL Gąbka polerska na rzep
 DE Klett-Polierschwamm
 RU Губка для полировки с липучкой
 CZ Leštící houba na suchý zip
 HU Tépőzáras polírozó szivacs
 RO Burete de lustruit cu scai
 FR Éponge de polissage avec velcro
 IT Tampone in spugna con velcro
 ES Esponja de pulido con velcro
 CN 海绵抛光盘

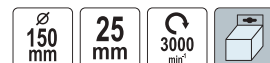

YATO	Sponge hardness / Twardość gąbki	
YT-47892	miękka	200
YT-47893	średnio twarda	150
YT-47894	twarda	200
YT-47895	bardzo twarda	200

EN Hook and loop sanding sponge
PL Gąbka ścierna na rzep
DE Klett-Schleifschwamm
RU Губка полировальная с липучкой
CZ Abrazivní houba na suchý zip
HU Tépözárás csiszolószivacs
RO Burete de șlefuit cu scai
FR Éponge abrasive à velcro
IT Spugna abrasiva con velcro
ES Esponja abrasiva con velcro
CN 海绵抛光盘



YATO 	
YT-47896	200



EN Thread adapter
PL Adapter z gwintem
DE Adapter mit Gewinde
RU Адаптер с винтом
CZ Adaptér se závitem
HU Menetes adapter
RO Adaptor cu filet
FR Adaptateur avec filetage
IT Adattatore con filettatura
ES Adaptador con rosca
CN 接杆

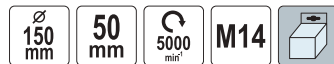

YATO 	Ø [mm]	
YT-47868	6	500

EN Polishing pad
PL Pad polerski
DE Polierpad
RU Диск полировальный
CZ Leštící kotouč
HU Polírozó tárcsa
RO Disc de lustruit
FR Tampon de polissage
IT Disco lucidatura
ES Pad de pulido
CN 海绵抛光盘



YATO 	Sponge hardness / Twardość gąbki	
YT-47880	miękka	60
YT-47881	średnio twarda	60
YT-47882	twarda	60
YT-47883	bardzo twarda	60



EN Polishing pad with sanding sponge
PL Pad polerski z gąbką ścierną
DE Polierpad mit Schleifschwamm
RU Диск полировальный с губкой
CZ Leštící kotouč abrazivní houba
HU Polírozó tárcsa csiszolószivaccsal
RO Disc de lustruit cu burete de șlefuit
FR Tampon de polissage avec éponge abrasive
IT Tampone lucidante con spugna abrasiva
ES Pad de pulido con esponja abrasiva
CN 海绵抛光盘



YATO 	
YT-47884	60



EN Polishing felt
PL Filc polerski
DE Polierfilz
RU Диск с войлоком для полировки
CZ Leštící filc
HU Poplírozó filc
RO Pâslă de lustruire
FR Feutre de polissage
IT Disco in feltro per lucidatura
ES Fieltro de pulido
CN 羊毛抛光盘



YATO 	Ø [mm]	H [mm]	
YT-47902	75	10	200
YT-47901	125	10	150
YT-47900	125	20	100

EN Hook and loop buffing pad
PL Futro polerskie na rzep
DE Klett-Polierfell
RU Полировальный меховой круг на липучке
CZ Vlněný leštící kotouč na suchý zip
HU Tépözárás gyapjas polírozó korong
RO Tampă de lustruire cu scai
FR Tampon de polissage à velcro
IT Pelliccia lucidante con velcro
ES Piel de pulido con velcro
CN 羊毛抛光盘



YATO 	Ø [mm]	
YT-47910	80	200
YT-47911	125	100
YT-47912	150	80
YT-47913	180	60

EN Polishing pad kit
 PL Zestaw do polerowania
 DE Polierpad-Set
 RU Набор для полировки
 CZ Leštící sada
 HU Polírozó készlet
 RO Kit discuri de lustruit
 FR Kit de polissage
 IT Kit per lucidatura
 ES Conjunto para pulido
 CN 抛光海绵

12 PCS **80** mm **6000** min² **M10**



YATO	Ø [mm]	
YT-47930	80	80

EN Polishing pad kit
 PL Zestaw do polerowania
 DE Polierpad-Set
 RU Набор для полировки
 CZ Leštící sada
 HU Polírozó készlet
 RO Kit discuri de lustruit
 FR Kit de polissage
 IT Kit per lucidatura
 ES Conjunto para pulido
 CN 抛光海绵

8 PCS **180** mm **6000** min² **M14**



YATO	Ø [mm]	
YT-47933	180	30

EN Polishing sponges for rims
 PL Gąbki polerskie do felg
 DE Polierschwämme für Felgen
 RU Полировальные губки для автомобильных шин
 CZ Leštící houby na ráfky
 HU Felincsiszoló szivacsok
 RO Bureți de lustruit pt. jante
 FR Éponges de polissage des jantes
 IT Spugne lucidanti per cerchi
 ES Esponjas de pulido para llantas
 CN 海绵抛光轮

3 PCS **30-75** mm **80** mm **6000** min² **6** mm



YATO	Ø [mm]	
YT-47945	30-75	100

EN Polishing pad kit
 PL Zestaw do polerowania
 DE Polierpad-Set
 RU Набор для полировки
 CZ Leštící sada
 HU Polírozó készlet
 RO Kit discuri de lustruit
 FR Kit de polissage
 IT Kit per lucidatura
 ES Conjunto para pulido
 CN 抛光海绵

12 PCS **6000** min² **M14**



YATO	Ø [mm]	
YT-47931	125	30
YT-47932	150	30

EN Polishing pads
 PL Nakładki polerskie
 DE Polierhauben
 RU Накладки для полировки
 CZ Leštící kotouče
 HU Polírozó sapkák
 RO Discuri de lustruit
 FR Tampons de polissage
 IT Cuffie per lucidatura
 ES Almohadillas para pulido
 CN 仿毛抛光盘

2 PCS **250** mm **5000** min²



For YT-82922
 Dla YT-82922

YATO	Ø [mm]	
YT-47940	250	60

Memo

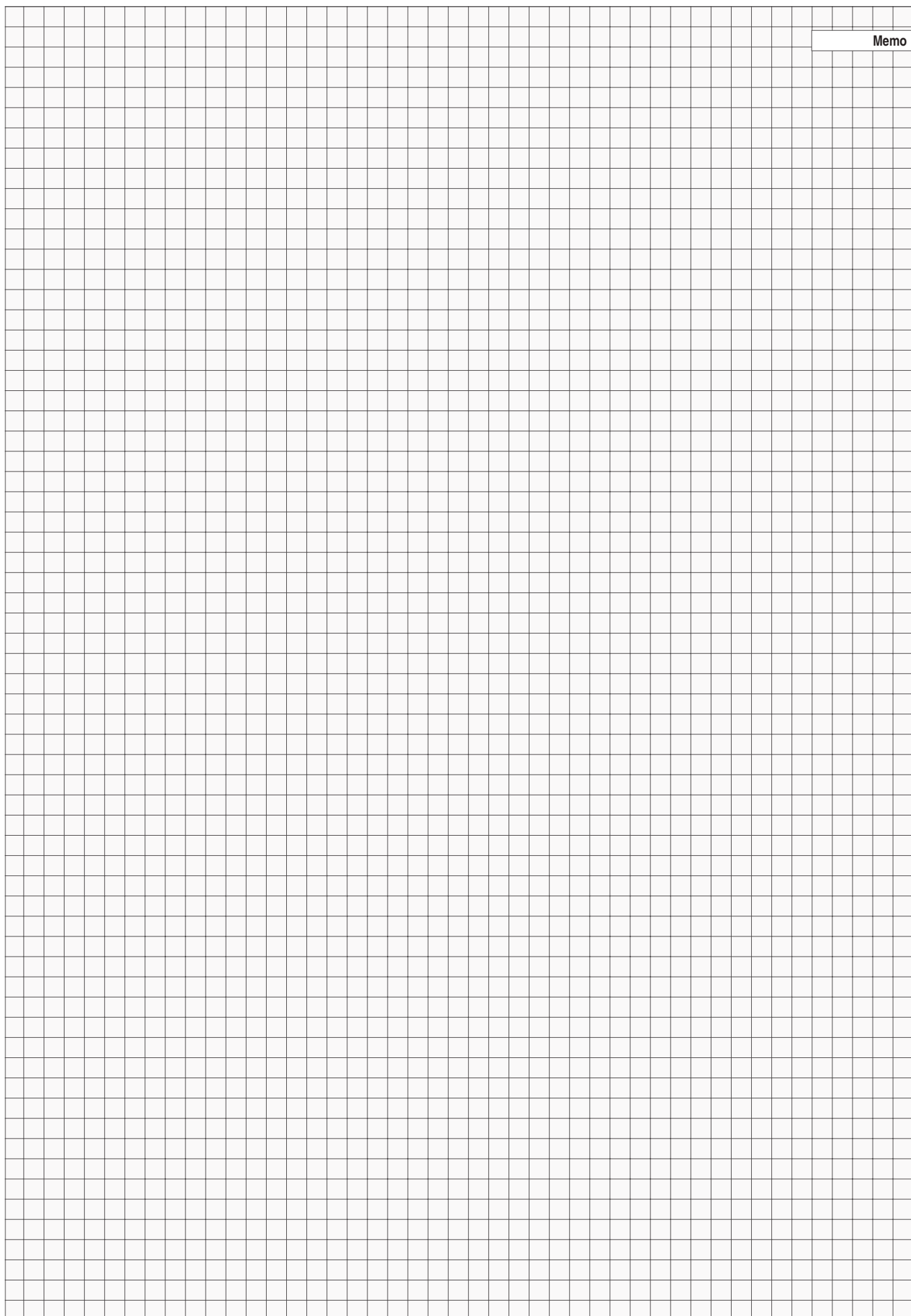

11

Plumbing tools Narzędzia hydrauliczne



<p>Ratchet die stock sets Gwintownice ręczne z zestawem głowic</p> <p>238</p>		<p>Calibrators Kalibratory</p> <p>248</p>	
<p>Accessories for ratchet die stock Akcesoria do gwintownic ręcznych</p> <p>238</p>		<p>Pipe welders Zgrzewarki do rur</p> <p>248</p>	
<p>Pipe wrenches Klucze do rur</p> <p>239-240</p>		<p>Pipe crimping pliers & accessories Zaciskarki do rur i akcesoria</p> <p>249-250</p>	
<p>Strap wrenches Klucze do rur taśmowe</p> <p>240</p>		<p>Hinged pipe vices Imadła zaciskowe do rur</p> <p>250</p>	
<p>Chain pipe wrenches Klucze do rur łańcuchowe</p> <p>240</p>		<p>Thread seal strings Nici do uszczelniania gwintów</p> <p>250</p>	
<p>Water pump pliers Szcypce nastawne</p> <p>241</p>		<p>Plumbing accessories Akcesoria hydrauliczne</p> <p>250-251</p>	
<p>Step wrenches Klucze sztorcowe</p> <p>241-242</p>		<p>Deburrers & accessories Gratowniki i akcesoria</p> <p>251</p>	
<p>Pipe cutters Obcinaki do rur</p> <p>243-246</p>		<p>Pipe brushes Szczotki do rur</p> <p>252</p>	
<p>Pipe benders Giętarki do rur</p> <p>246-247</p>		<p>Cleaning pads for pipes Włókniny do czyszczenia rur</p> <p>252</p>	
<p>Hand flaring tools sets Praski do rozszerzania rur</p> <p>247-248</p>		<p>Drain cleaning accessories Akcesoria do udrażniania kanalizacji</p> <p>252-253</p>	

- EN Ratchet die stocks
- PL Gwintownica z zestawem glowic
- DE Rohrgewindeschneidsatz
- RU Клуппы трубные
- CZ Sada závitníků
- HU Menetfúró készlet
- RO Set filiere cu clichet
- FR Kit de filetage de tuyau
- IT Kit per filettatura tubi
- ES Tarrajas para tubo
- CN 管子铰板组套



5 PCS	3/8" 9.5 mm	1/2" 12.7 mm	3/4" 19 mm
1" 25 mm		9Cr2	

YATO	Size / Rozmiar	
YT-29001	3/8" (9.5 mm), 1/2" (12.7 mm), 3/4" (19.0 mm), 1" (25.0 mm)	4

- EN Ratchet die stocks
- PL Gwintownica z zestawem glowic
- DE Rohrgewindeschneidsatz
- RU Клуппы трубные
- CZ Sada závitníků
- HU Menetfúró készlet
- RO Set filiere cu clichet
- FR Kit de filetage de tuyau
- IT Kit per filettatura tubi
- ES Tarrajas para tubo
- CN 管子铰板组套



7 PCS	1/4" 6.3 mm	3/8" 9.5 mm	1/2" 12.7 mm	3/4" 19 mm
1" 25 mm	1 1/4" 32 mm		9Cr2	

YATO	Size / Rozmiar	
YT-2900	1/4" (6.3 mm), 3/8" (9.5 mm), 1/2" (12.7 mm), 3/4" (19.0 mm), 1" (25.0 mm), 1-1/4" (32.0 mm)	4

- EN Ratchet die stocks
- PL Gwintownica z zestawem glowic
- DE Rohrgewinde-Schneidbacken
- RU Клуппы трубные
- CZ Sada závitníků
- HU Menetfúró készlet
- RO Set filiere cu clichet
- FR Kit de filetage de tuyau
- IT Kit per filettatura tubi
- ES Tarrajas para tubo
- CN 管子铰板组套



7 PCS	1/2" 12.7 mm	3/4" 19 mm	1" 25 mm	1 1/4" 32 mm
1.5" 38 mm	2" 50 mm		9Cr2	

YATO	Size / Rozmiar	
YT-29003	1/2" (12.7 mm), 3/4" (19.0 mm), 1" (25.0 mm), 1-1/4" (32.0 mm), 1-1/2" (38.0 mm), 2" (50.0 mm)	2

- EN Spare knives for ratchet die stock
- PL Noże zapasowe do gwintownicy ręcznej
- DE Rohrgewinde-Schneidbacken
- RU Запасные ножи для оправки
- CZ Náhradní nože do ruční závitofeu
- HU Tartalék kések, racsnis csőmenetvágóhoz
- RO Cutit de rezerva pt. filiera
- FR Lame pour taraud à main
- IT Lame di ricambio per filettatrici manuale
- ES Filos de recambio para terraja de mano
- CN 板牙



4 PCS	9Cr2	
----------	------	--

- EN Spare head for ratchet die stock
- PL Glowica zapasowa do gwintownicy ręcznej
- DE Rohrgewinde-Schneidköpfe
- RU Запасная оправка для нарезания трубной резьбы
- CZ Náhradní hlava pro ruční závitofeu
- HU Tartalék fej, racsnis csőmenetvágóhoz
- RO Cap de rezerva pt. placa filetat cu clichet
- FR Mandrin porte-taraud
- IT Testina ricambio per filettatrici manuale
- ES Cabeza de recambio para terraja de mano
- CN 板牙头



9Cr2	
------	--

YATO	Size / Rozmiar	pcs / szt.	
YT-2910	1/4" (6.3 mm)	4	50/200
YT-2911	3/8" (10.0 mm)	4	50/200
YT-2912	1/2" (12.5 mm)	4	50/200
YT-2913	3/4" (19.0 mm)	4	50/200
YT-2914	1" (25.0 mm)	4	50/200

YATO	Size / Rozmiar	
YT-2916	1/4" (6.3 mm)	10/40
YT-2917	3/8" (10.0 mm)	10/40
YT-2918	1/2" (12.5 mm)	10/40
YT-2919	3/4" (19.0 mm)	10/40
YT-2920	1" (25.0 mm)	10/40
YT-2921	1-1/4" (32.0 mm)	10/20

EN Pipe wrench
PL Klucz do rur
DE Rohrschlüssel
RU Ключ трубный

CZ Klíč součásti na trubky
HU Csőkulcs
RO Cheie reglabila pt. tevi
FR Clé aux tubes

IT Chiave per tubi
ES Llave para tubos
CN 铝合金管钳



YATO	Size / Rozmiar	L [mm]	Max. pipe diameter / Maks. średnica rury	
YT-2482	14"	350	2" (50 mm)	6/12
YT-2483	18"	450	2.5" (63 mm)	2/10
YT-2484	24"	600	3" (75 mm)	2/6
YT-2485	36"	900	5" (125 mm)	3

EN Pipe wrench
PL Klucz do rur
DE Rohrschlüssel
RU Ключ трубный

CZ Klíč součásti na trubky
HU Csőkulcs
RO Cheie reglabila pt. tevi
FR Clé aux tubes

IT Chiave per tubi
ES Llave para tubos
CN 铝合金重型管钳



YATO	Size / Rozmiar	L [mm]	Max. pipe diameter / Maks. średnica rury	
YT-2222	12"	300	1" (25 mm)	6/24
YT-2223	14"	350	1.5" (38 mm)	4/16
YT-2224	18"	450	2" (50 mm)	3/12
YT-2225	24"	600	2.5" (63 mm)	3/6

EN Telescopic pipe wrench
PL Teleskopowy klucz do rur
DE Teleskop-Rohrschlüssel

RU Телескопический трубный гаечный ключ
CZ Teleskopický klíč do trubek
HU Teleszkópos csőfogó kulcs

RO Cheie pt. tevi telescopica
FR Clé telescopique pour tuyaux
IT Chiave giratubi telescopica

EN Pipe wrench
PL Klucz do rur
DE Rohrschlüssel
RU Ключ трубный

CZ Klíč součásti na trubky
HU Csőkulcs
RO Cheie reglabila pt. tevi
FR Clé aux tubes

IT Chiave per tubi
ES Llave para tubos
CN 加重型管钳



YATO	Size / Rozmiar	L [mm]	Max. pipe diameter / Maks. średnica rury	
YT-2488	10"	250	1" (25 mm)	6/18
YT-2489	12"	300	1.5" (38 mm)	6/12
YT-2490	14"	350	2" (50 mm)	2/10
YT-2491	18"	450	2.5" (63 mm)	3/6
YT-2492	24"	600	3" (75 mm)	2/4
YT-2493	36"	900	5" (125 mm)	1
YT-2494	48"	1200	6" (150 mm)	1

EN Pipe wrench
PL Klucz do rur
DE Rohrschlüssel
RU Ключ трубный

CZ Klíč součásti na trubky
HU Csőkulcs
RO Cheie reglabila pt. tevi
FR Clé aux tubes

IT Chiave per tubi
ES Llave para tubos
CN 偏置式重型管钳



YATO	Size / Rozmiar	L [mm]	Max. pipe diameter / Maks. średnica rury	
YT-2201	10"	250	1" (25 mm)	6/36
YT-2203	14"	350	1.5" (38 mm)	4/16
YT-2204	18"	450	2" (50 mm)	3/12
YT-2205	24"	600	2.5" (63 mm)	3/6
YT-2206	36"	900	4" (100 mm)	2/4

EN Llave telescópica para tubos
CN 管子钳



YATO	Size / Rozmiar	L [mm]	Max. pipe diameter / Maks. średnica rury [mm]	
YT-22257	16", 18", 20", 22"	400-550	80	8

EN Adjustable pipe wrench
PL Klucz nastawny do rur
DE Rohrschlüssel

RU Ключ трубный переставной
CZ Nastavitelný klíč na trubky
HU Állítható csőkulcs

RO Cheie reglabilă pt. țevi
FR Clé serre-tube „suédoise”
IT Pinze regolabili per tubi

ES Llave para tubos
CN 管钳

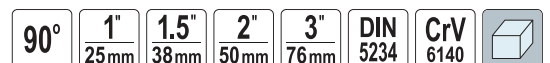

YATO	L [mm]	Max. pipe diameter / Maks. średnica rury	
YT-2210	320	1" (25 mm)	24
YT-2211	420	1-1/2" (38 mm)	18
YT-2212	560	2" (50 mm)	12
YT-22123	630	3" (76 mm)	4

EN Adjustable pipe wrench
 PL Klucz nastawny do rur
 DE Rohrschlüssel

RU Ключ трубный переставной
 CZ Nastavitelný klíč na trubky
 HU Állítható csőkulcs

RO Cheie reglabilă pt. țevi
 FR Clé serre-tube „suédois”
 IT Pinze regolabili per tubi

ES Llave para tubos
 CN 管钳

45° 1" 25mm 1.5" 38mm 2" 50mm 3" 76mm DIN 5234 CrV 6140



YATO	L [mm]	Max. pipe diameter / Maks. średnica rury	
YT-2213	330	1" (25 mm)	24
YT-2214	415	1-1/2" (38 mm)	18
YT-2215	530	2" (50 mm)	12
YT-22153	650	3" (76 mm)	4

EN Adjustable pipe wrench
 PL Klucz nastawny do rur
 DE Rohrschlüssel

RU Ключ трубный переставной
 CZ Nastavitelný klíč na trubky
 HU Állítható csőkulcs

RO Cheie reglabilă pt. țevi
 FR Clé serre-tube „suédois”
 IT Pinze regolabili per tubi

ES Llave para tubos
 CN 弯嘴鹰嘴钳

S 1" 25mm 1.5" 38mm 2" 50mm 3" 76mm DIN 5234 CrV 6140



YATO	L [mm]	Max. pipe diameter / Maks. średnica rury	
YT-2216	330	1" (25 mm)	24
YT-2217	420	1-1/2" (38 mm)	18
YT-2218	535	2" (50 mm)	12
YT-22183	650	3" (76 mm)	4

EN Auto-adjustable pipe wrench
 PL Szybkonastawny klucz do rur
 DE Rollgabelschlüssel

RU Ключ разводной
 CZ Nastavitelný klíč
 HU Állítható svédkulcs

RO Cheie reglabilă
 FR Clé à molette
 IT Chiave autoregolabile per tubi

ES Llave ajustable
 CN 可调式管钳

300mm 5/8"-11/2" 16-38mm SELF-ADJUSTING SAMO-NASTAWNY QUICK OPENING SZYBKE OTWIERANIE HRC 46-52 HARDENED JAWS HARTOWANE SZCZĘKI

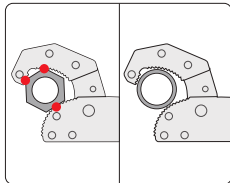

YATO	L [mm]	
YT-22005	300	6/24

EN Pipe wrench - german type
 PL Klucz do rur - typ niemiecki
 DE Rohrschlüssel - deutsch type
 RU Трубный ключ - немецкий тип
 CZ Nastavitelný klíč na trubky - němečina typ
 HU Állítható csőkulcs - német típusú

RO Cheie reglabilă pt. țevi - tip german
 FR Clé serre-tube type allemand
 IT Chiave per tubi - tipo tedesco
 ES Llave para tubos tipo alemán
 CN 德式管子钳

HRC 47-53
 HARDENED JAWS HARTOWANE SZCZĘKI



YATO	Size / Rozmiar	L [mm]	Max. jaws opening capacity / Maks. zakres rozwarcia szczęk [mm]	Max. pipe diameter / Maks. średnica rury [mm]	
YT-22000	7"	175	45	20	6/60
YT-22001	9"	225	60	30	6/36
YT-22002	10.5"	275	70	35	6/24

EN Strap for pipe wrench
 PL Taśma zapasowa do klucza do rur
 DE Gurt für Bandschlüssel
 RU Ремень для ремешковых ключей
 CZ Popruh pro klíče olejových filtrů
 HU Szíjas az szíjas csőfogó

RO Chinga la chei cu chingă
 FR Courroie pour clés a courroie
 IT Nastro di ricambio per chiave per tubi
 ES Correa a llaves de correa
 CN 皮带管钳配件

ø8" 28x825mm 200mm NYLON AI

- Chromed pipes
- PVC pipes
- Oil filters
- Rury chromowane
- Rury PCV
- Filtry oleju

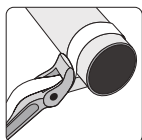

For YT-22255
 Dla YT-22255

YATO	L [mm]	
YT-22256	50	

EN Telescopic pipe wrench
 PL Teleskopowy klucz do rur
 DE Teleskop-Rohrschlüssel
 RU Телескопический трубный гаечный ключ
 CZ Teleskopický klíč do trubek
 HU Teleszkópos csőfogó kulcs

RO Cheie pt. țevi telescopica
 FR Clé télescopique pour tuyaux
 IT Chiave telescopica per tubi
 ES Llave telescópica para tubos
 CN 皮带管钳

ø8" 300mm 28x825mm NYLON AI

- Chromed pipes
- PVC pipes
- Oil filters
- Rury chromowane
- Rury PCV
- Filtry oleju

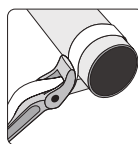

YATO	L [mm]	Max. pipe diameter / Maks. średnica rury	
YT-22255	300	8" (200 mm)	5/50

EN Chain pipe wrench
 PL Klucz łańcuchowy do rur
 DE Kettenrohrzange
 RU Ключ цепной для труб
 CZ Klíč řetězový na trubky
 HU Láncos csőfogó
 RO Cheie reglabilă pt. țevi cu lant
 FR Clé à chaîne
 IT Chiave a catena per tubi
 ES Llave de cadena
 CN 链条扳手

ø4" 300mm 100mm INDUCTION HARDENED TEETH ZĘBY HARTOWANE NIEKRYWANE ADJUSTABLE WORK RANGE REGULOWANY ZAKRES PRACY



YATO	L [mm]	Max. pipe diameter / Maks. średnica rury	
YT-22260	300	4" (100 mm)	6/24

EN Water pump pliers
PL Szczypce nastawne
DE Wasserpumpenzange
RU Клещи переставные
CZ Nastavitelné kleště
HU Állítható fogó

RO Cleste papagal
FR Pince réglable
IT Pinze regolabili
ES Tenaza ajustable
CN 水泵钳

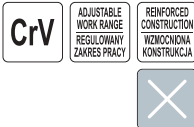

YATO	L [mm]	
YT-2090	250	6/36
YT-2091	300	6/36

EN Water pump pliers
PL Szczypce nastawne
DE Wasserpumpenzange
RU Клещи переставные
CZ Nastavitelné kleště
HU Állítható fogó

RO Cleste papagal
FR Pince réglable
IT Pinze regolabili
ES Tenaza ajustable
CN 水泵钳

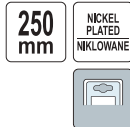

YATO	L [mm]	
YT-2069	250	6/36

EN Water pump pliers
PL Szczypce nastawne
DE Wasserpumpenzange
RU Клещи переставные
CZ Nastavitelné kleště
HU Állítható fogó

RO Cleste papagal
FR Pince réglable
IT Pinze regolabili
ES Tenaza ajustable
CN 水泵钳

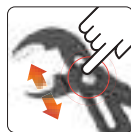

YATO	Jaws width / Szerokość szczęk [mm]	L [mm]	
YT-20890	30	175	6/72
YT-20891	38	240	6/60
YT-20892	50	300	6/36
YT-20893	95	415	6/24

EN Step wrench
PL Klucz stopniowy
DE Stufenschlüssel
RU Универсальный ступенчатый ключ
CZ Klič na radiátorové šroubení
HU Lépcsős radiátor kulcs

RO Cheie in trepte pt. radiator
FR Clé de montage étagée
IT Chiave gradini per radiatori
ES Llave de radiadores
CN 六角阶梯扳手



For YT-03315
Dla YT-03315



YATO	
YT-03316	100

EN Water pump pliers
PL Szczypce nastawne
DE Wasserpumpenzange
RU Клещи переставные
HU Állítható fogó

RO Cleste papagal
FR Pince réglable
IT Pinze regolabili
ES Tenaza ajustable
CN 水泵钳

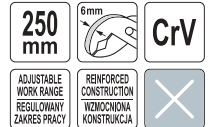

YATO	L [mm]	
YT-20911	250	6/36

EN Water pump pliers
PL Szczypce nastawne
DE Wasserpumpenzange
RU Клещи переставные
CZ Nastavitelné kleště
HU Állítható fogó

RO Cleste papagal
FR Pince réglable
IT Pinze regolabili
ES Tenaza ajustable
CN 水泵钳



YATO	L [mm]	
YT-2070	250	6/24

EN Internal ratchet wrench
PL Grzechotka wewnętrzna
DE Innenratschenschlüssel
RU Трещотка внутренняя
CZ Radiátorový kluč s ráčnou
HU Lépcsős kulcskészlet racsnival

RO Cheie robinet radiator
FR Clé de montage étagée
IT Cricchetto di tipo interno
ES Llave carraca radiadores
CN 穿心棘轮扳手



For YT-03316
Dla YT-03316

YATO	
YT-03315	6/24

EN Step wrench with ratchet
PL Klucz stopniowy z grzechotką
DE Stufenschlüssel mit Ratsche
RU Ключ ступенчатый с трещоткой
CZ Klič na šroubení s ráčnou
HU Racsnis lépcsős kulcs

RO Cheie in trepte cu clichet
FR Clé de montage étagée avec cliquet
IT Chiave gradini per radiatori con cricchetto
ES Llave de radiadores con trinquete
CN 穿心棘轮扳手



3/8" (9.5 mm), 29/68" (11.6 mm), 1/2" (12.7 mm), 21/32" (16.4 mm), 27/32" (21 mm)

YATO	
YT-03314	6/24

EN Step wrench
 PL Klucz stopniowy
 DE Stufenschlüssel
 RU Универсальный ступенчатый ключ
 CZ Klíč na radiátorové šroubení
 HU Lépcsős radiátor kulcs

RO Cheie in trepte pt. radiator
 FR Clé de montage étagée
 IT Chiave gradini per radiatori
 ES Llave de radiadores
 CN 六角阶梯扳手

1/2"
 12.7 mm

CrV



For YT-03315
 Dla YT-03315

YATO	○	
YT-03317	1/2" (12.7 mm)	100

EN Hole cutter for water taps
 PL Wycinak otworów pod kran
 DE Lochschneider für Wasserhähne
 RU Устройство для вырезания отверстий под смеситель
 CZ Vykružovač otvorů pro vodovodní baterii
 HU Csavaros lyukkvívógó
 RO Dispozitiv de tăiat găuri pt. robinete de apă
 FR Outil de coupe de trou pour robinets
 IT Punzonatrice a vite per rubinetti
 ES Cortador de agujeros para grifos
 CN 冲孔器

HRC
 48-52

40Cr



YATO	Ø [mm]	
YT-21955	25	5/30
YT-21956	32	5/30
YT-21957	35	5/30

EN Faucet reseating tool
 PL Frez do napraw kranów
 DE Wasserhahn-Ventil-Sitzfraeser
 RU Фреза для ремонта седла клапанов смесителей
 CZ Fréza na sedla vodovodních baterii
 HU Szelepfészekmaró
 RO Dispozitiv rectificat valve
 FR Appareil à fraiser pour réparer les robinets
 IT Fresa per rubinetti
 ES Fresa para reparación de grifos
 CN 水阀修理器

G3/8

G1/2



YATO		
YT-21960		5/50

EN Nipple extractor set
 PL Zestaw do wykręcania nypeli
 DE Nippelschlüssel-Satz
 RU Набор для выкручивания ниппелей
 CZ Souprava pro vyšroubování vodovodních redukci
 HU Belső csökulcs
 RO Set extractoare capete filetate rupte ale tevii
 FR Jeu de porte-embouts pour dévisser mamelons
 IT Set di chavi per rimozione nippeli
 ES Juego extractor de niples
 CN 内管扳手



3/8"
 9.5 mm

1/2"
 12.7 mm

3/4"
 19 mm

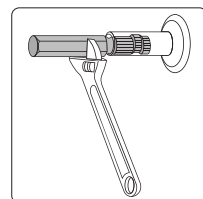

YATO		
YT-21793		6/24

EN Step wrench
 PL Klucz stopniowy
 DE Stufenschlüssel
 RU Универсальный ступенчатый ключ
 CZ Klíč na radiátorové šroubení
 HU Lépcsős radiátor kulcs
 RO Cheie in trepte pt. radiator
 IT Chiave a cricco
 ES Llave de radiadores
 CN 六角阶梯扳手

1/2-1 1/4"

CrV



YATO		
YT-03318		10/60

EN Special mixer-tap basin wrench
 PL Klucz lamany do instalacji armatury
 DE Standhahnmutterschlüssel für Armaturen
 RU Сгибающийся гаечный ключ для фитингов
 CZ Lámaný klíč na vodovodní baterie
 HU Derékszögű csaptelep kulcs
 RO Chei speciale pt. robineti si bazine
 FR Clé écrou robinet
 IT Chiave pieghevole per dadi e rubinetti
 ES Llave articulada para plomería
 CN 水槽扳手

6
 PCS



8, 9, 10, 11, 12 mm

YATO		
YT-24780		20/40

EN Sink wrench
 PL Teleskopowy klucz hakowy do armatury
 DE Teleskop-Hakenschlüssel für Armaturen
 RU Ключ для раковины телескопический
 CZ Teleskopický umyvadlový klíč
 HU Teleszkópos csaptelepkulcs
 RO Cheie telescopică pt. chiuvetă
 FR Clé à siphon télescopique
 IT Chiave telescopica per lavabo
 ES Llave para lavabo telescópica
 CN 水槽扳手

1 1/4-2 1/2"
 32-63.5 mm

23-41
 cm

180°



YATO		
YT-22251		6/12

EN PVC pipe cutter
PL Obcinak do rur PVC
DE PVC Rohrabsschneider
RU Труборез для ПВХ труб
CZ Rezač PVC trubek
HU Csővágó olló PVC csővekhez

RO Foarfecă pt. tăiat țevi din PVC
FR Coupe-tube en PVC
IT Cesolia per tubi in PVC
ES Tijera cortatubos para PVC
CN PVC管子割刀



max Ø 35 mm
PEX
PVC PP PU PE
HRC 54
8Cr13

YATO	max. Ø [mm]	
YT-2230	35	6/48

EN PVC pipe cutter
PL Obcinak do rur PVC
DE PVC Rohrabsschneider
RU Труборез для ПВХ труб
CZ Rezač PVC trubek
HU Csővágó olló PVC csővekhez
RO Foarfecă pt. tăiat țevi din PVC
FR Coupe-tube en PVC
IT Cesolia per tubi in PVC
ES Tijera cortatubos para PVC
CN PVC管子割刀



max Ø 42 mm
PEX
PVC PP PU PE
HRC 54
8Cr13
RATCHET SYSTEM ZAPADKOWY
QUICK OPENING SZYBKE OTWIERANIE



YATO	max. Ø [mm]	
YT-2231	42	6/48

EN PVC pipe cutter
PL Obcinak do rur PVC
DE PVC Rohrabsschneider
RU Труборез для ПВХ труб
CZ Rezač PVC trubek
HU Csővágó olló PVC csővekhez
RO Foarfecă pt. tăiat țevi din PVC
FR Coupe-tube en PVC
IT Cesolia per tubi in PVC
ES Tijera cortatubos para PVC
CN PVC管子割刀



max Ø 63 mm
PEX
PVC PP PU PE
HRC 56-58
8Cr13
RATCHET SYSTEM ZAPADKOWY
QUICK OPENING SZYBKE OTWIERANIE



YATO	max. Ø [mm]	
YT-22312	63	6/24

EN PVC pipe cutter
PL Obcinak do rur PVC
DE PVC Rohrabsschneider

RU Труборез для ПВХ труб
CZ Rezač PVC trubek
HU Csővágó olló PVC csővekhez

RO Clește pt. tăiat țevi din PVC
FR Coupeur aux tubes
IT Taglia tubi PVC

ES Cortatubos PVC
CN 管子割刀

PEX
PVC PP PU PE
HRC 54
8Cr13
AI
RATCHET SYSTEM ZAPADKOWY
QUICK OPENING SZYBKE OTWIERANIE



max Ø 51 mm

YATO	max. Ø [mm]	
YT-2228	51	6/24



max Ø 64 mm

YATO	max. Ø [mm]	
YT-2229	64	6/24

EN PVC pipe cutter
PL Obcinak do rur PVC
DE PVC Rohrabsschneider
RU Труборез для труб из ПВХ

CZ Rezač PVC trubek
HU Csővágó olló PVC csővekhez
RO Clește pt. tăiat țevi din PVC
FR Coupe-tubes PVC a cliquet

IT Taglia tubi PVC
ES Cortatubos para PVC
CN PVC 管子割刀

PVC PP PU PE
PTFE
SK5
AI



max Ø 42 mm

YATO	max. Ø [mm]	
YT-22271	42	10/40

max Ø 36 mm

YATO	max. Ø [mm]	
YT-22270	36	10/50



max Ø 50 mm

YATO	max. Ø [mm]	
YT-22272	50	10/30



max Ø 63 mm

YATO	max. Ø [mm]	
YT-22273	63	10/30



max Ø 75 mm

YATO	max. Ø [mm]	
YT-22274	75	10/30

EN PE pipe cutter
 PL Obcinak do rur PE
 DE PE Rohrabrschneider
 RU Труборез для ПЭ трубы
 CZ Rezač PE trubek
 HU Csővágó olló PE csövekhez
 RO Foarfecă pt. tăiat țevi din PE
 FR Coupe-tube en PE
 IT Cesovia per tubi in PE
 ES Tijera cortatubos para PE
 CN 管子割刀

max. Ø **64 mm** PVC PP PU PE PTFE SK5 AI



YATO	max. Ø [mm]	
YT-22295	64	6/24

EN PVC pipe cutter
 PL Obcinak do rur PVC
 DE PVC Rohrabrschneider
 RU Труборез для ПВХ трубы
 CZ Rezač PVC trubek
 HU Csővágó olló PVC csövekhez

RO Foarfecă pt. tăiat țevi din PVC
 FR Coupe-tube en PVC
 IT Cesovia per tubi in PVC
 ES Tijera cortatubos para PVC
 CN PVC管子割刀

Ø **32 mm** PVC PP PU PE SK5 AI



YATO	max. Ø [mm]	
YT-22301	32	12/120

EN PVC pipe cutter
 PL Obcinak do rur PVC
 DE PVC Rohrabrschneider
 RU Труборез для ПВХ трубы
 CZ Rezač PVC trubek
 HU Csővágó olló PVC csövekhez
 RO Foarfecă pt. tăiat țevi din PVC
 FR Coupe-tube en PVC
 IT Cesovia per tubi in PVC
 ES Tijera cortatubos para PVC
 CN PVC管子割刀

max. Ø **42 mm** PVC PP PU PE HRC **54** 8Cr13 AI



YATO	max. Ø [mm]	
YT-22292	42	6/48

EN PVC pipe cutter
 PL Obcinak do rur PVC
 DE PVC Rohrabrschneider
 RU Труборез для ПВХ трубы
 CZ Rezač PVC trubek
 HU Csővágó olló PVC csövekhez
 RO Foarfecă pt. tăiat țevi din PVC
 FR Coupe-tube en PVC
 IT Cesovia per tubi in PVC
 ES Tijera cortatubos para PVC
 CN PVC管子割刀

max. Ø **64 mm** PVC PP PU PE HRC **54** 8Cr13 AI



YATO	max. Ø [mm]	
YT-22293	64	6/24

EN Pipe deburrer
 PL Gratownik do rur
 DE Rohrentgrater
 RU Гратосниматель для труб
 CZ Odhrotovač trubek
 HU Sorjázó
 RO Debavuror pt. tevi
 FR Ébavureur de tuyaux
 IT Sbavatore per tubi
 ES Desbarbador de tubos
 CN 修边器

PE Ø **20-63 mm** HCS **65Mn**



YATO	Ø [mm]	
YT-22366	20, 25, 32, 40, 50, 63	150

EN Pipe cutter
 PL Obcinak do rur
 DE Rohrabrschneider
 RU Труборез для трубы
 CZ Rezač trubek
 HU Csővágó
 RO Dispozitiv pt. tăiat țevi
 FR Coupe-tube
 IT Tagliatubi
 ES Cortatubos
 CN 管子割刀

PEX PVC PP PU PE AI Cu BEARING STEEL STAL ŁOŻYSKOWA

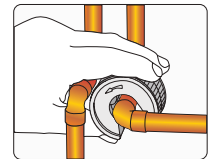

YATO	Cutting diameter / Średnica cięcia	External diameter / Średnica zewnętrzna [mm]	
YT-22353	19/32" (15 mm)	48	10/50
YT-22354	23/32" (18 mm)	59	10/50
YT-22355	7/8" (22 mm)	56	10/50

EN Pipe cutter
 PL Obcinak do rur
 DE Rohrabrschneider
 RU Труборез для трубы
 CZ Rezač trubek
 HU Csővágó
 RO Dispozitiv pt. tăiat țevi
 FR Coupe-tube
 IT Tagliatubi
 ES Cortatubos
 CN 管子割刀

PEX PVC PP PU PE AI Cu 1/10"-7/8" 3-22 mm BEARING STEEL STAL ŁOŻYSKOWA



YATO	Cutting diameter / Średnica cięcia	
YT-22318	1/10" - 7/8" (3-22 mm)	100

EN Pipe cutter
 PL Obcinak do rur
 DE Rohrabrschneider
 RU Труборез для трубы
 CZ Rezač trubek
 HU Csővágó
 RO Dispozitiv pt. tăiat țevi
 FR Coupe-tube
 IT Tagliatubi
 ES Cortatubos
 CN 管子割刀

PVC PP PU PE SS AI Cu Ø **3-28 mm** QUICK ADJUSTMENT SZEBKA REGULACJA HRC **56-62** 9CrSi



YATO	Cutting diameter / Średnica cięcia [mm]	
YT-22341	3-28	10/60

EN Pipe cutter
PL Obcinak do rur
DE Rohrabsschneider
RU Труборез для труб
CZ Rezač trubek
HU Csővágó
RO Dispozitiv pt. tăiat țevi
FR Coupe-tube
IT Tagliatubi
ES Cortatubos
CN 管子割刀



PVC PP PU PE SS Al Cu
3-28 mm
QUICK ADJUSTMENT SZYBKA REGULACJA
DEBURRER GRATOWNIK
HRC 56-62
9CrSi

YATO Cutting diameter / Średnica cięcia [mm] 6/48
YT-22342 3-28

EN Pipe cutter
PL Obcinak do rur
DE Rohrabsschneider
RU Труборез для труб
CZ Rezač trubek
HU Csővágó
RO Dispozitiv pt. tăiat țevi
FR Coupe-tube
IT Tagliatubi
ES Cortatubos
CN 管子割刀



PEX
PVC PP PU PE Al Cu
1/10"-5/4"
3-32 mm
QUICK ADJUSTMENT SZYBKA REGULACJA
DEBURRER GRATOWNIK
BEARING STEEL STAL ŁOŻYSKOWA
SPARE CUTTING WHEEL ZAPASOWE KÓŁKO TNĄCE

YATO Cutting diameter / Średnica cięcia 50
YT-22338 1/10" - 1-1/4" (3-32 mm)

EN Pipe cutter
PL Obcinak do rur
DE Rohrabsschneider
RU Труборез для труб
CZ Rezač trubek
HU Csővágó
RO Dispozitiv pt. tăiat țevi
FR Coupe-tube
IT Tagliatubi
ES Cortatubos
CN 管子割刀



PEX
PVC PP PU PE SS Al Cu
3/8"-1 5/8"
10-40 mm
BEARING STEEL STAL ŁOŻYSKOWA

YATO Cutting diameter / Średnica cięcia 20
YT-2232 3/8" - 1-5/8" (10-40 mm)

EN Pipe cutter
PL Obcinak do rur
DE Rohrabsschneider
RU Труборез для труб
CZ Rezač trubek
HU Csővágó
RO Dispozitiv pt. tăiat țevi
FR Coupe-tube
IT Tagliatubi
ES Cortatubos
CN 管子割刀



PEX
PVC PP PU PE Al Cu
1/4"-7/4"
6-45 mm
DEBURRER GRATOWNIK
BEARING STEEL STAL ŁOŻYSKOWA
SPARE CUTTING WHEEL ZAPASOWE KÓŁKO TNĄCE

YATO Cutting diameter / Średnica cięcia 25
YT-2233 1/4" - 1-3/4" (6-45 mm)

EN Pipe cutter
PL Obcinak do rur
DE Rohrabsschneider
RU Труборез для труб
CZ Rezač trubek
HU Csővágó
RO Dispozitiv pt. tăiat țevi
FR Coupe-tube
IT Tagliatubi
ES Cortatubos
CN 管子割刀



PVC PP PU PE SS Al Cu
16-54 mm
QUICK ADJUSTMENT SZYBKA REGULACJA
DEBURRER GRATOWNIK
HRC 56-62
9CrSi

YATO Cutting diameter / Średnica cięcia [mm] 4/16
YT-22344 16-54

EN Pipe cutter
PL Obcinak do rur
DE Rohrabsschneider
RU Труборез для труб
CZ Rezač trubek
HU Csővágó
RO Dispozitiv pt. tăiat țevi
FR Coupe-tube
IT Tagliatubi
ES Cortatubos
CN 管子割刀



PEX
PVC PP PU PE Al Cu
1/2"-2 1/2"
14-63 mm
QUICK ADJUSTMENT SZYBKA REGULACJA
BEARING STEEL STAL ŁOŻYSKOWA
SPARE CUTTING WHEEL ZAPASOWE KÓŁKO TNĄCE

YATO Cutting diameter / Średnica cięcia 25
YT-2234 1/2" - 2-1/2" (14-63 mm)

EN Pipe cutter
PL Obcinak do rur
DE Rohrabsschneider
RU Труборез для труб
CZ Rezač trubek
HU Csővágó
RO Dispozitiv pt. tăiat țevi
FR Coupe-tube
IT Tagliatubi
ES Cortatubos
CN 管子割刀



PEX
PVC PP PU PE Al Cu
2"-5"
50-127 mm
QUICK ADJUSTMENT SZYBKA REGULACJA
BEARING STEEL STAL ŁOŻYSKOWA

YATO Cutting diameter / Średnica cięcia 10
YT-2235 2" - 5" (50-127 mm)

EN Pipe cutter
PL Obcinak do rur
DE Rohrabsschneider
RU Труборез для труб
CZ Rezač trubek
HU Csővágó
RO Dispozitiv pt. tăiat țevi
FR Coupe-tube
IT Tagliatubi
ES Cortatubos
CN 管子割刀



PVC PP PU PE Al Cu
6-35 mm
DEBURRER GRATOWNIK
GCr15
SPARE CUTTING WHEEL ZAPASOWE KÓŁKO TNĄCE

YATO Cutting diameter / Średnica cięcia [mm] 5/50
YT-22332 6-35

EN Pipe cutter
PL Obcinak do rur
DE Rohrabsschneider
RU Труборез для труб
CZ Rezač trubek
HU Csővágó
RO Dispozitiv pt. tăiat țevi
FR Coupe-tube
IT Tagliatubi
ES Cortatubos
CN 管子割刀



PVC PP PU PE Al Cu
3-42 mm
DEBURRER GRATOWNIK
GCr15
SPARE CUTTING WHEEL ZAPASOWE KÓŁKO TNĄCE

YATO Cutting diameter / Średnica cięcia [mm] 4/32
YT-22333 3-42

EN Replacement cutting wheel for pipe cutters
 PL Zapasowe kółko tnące do obcinaka do rur
 DE Ersatzschneidrad für Rohrschneider
 RU Запасной режущий диск для труборезов
 CZ Náhradní fezné kolečko na trubky frézy
 HU Tartalék vágókerék cső vágó
 RO Roata de schimb pt. taiere tevi
 FR Molette pour coupe
 IT Ruota di ricambio per tagliatubi
 ES Rueda de corte de repuesto para cortatubos
 CN 管子割刀刀片

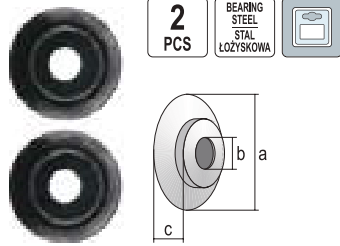

2 PCS
 BEARING STEEL STAL ŁOŻYSKOWA

EN Replacement cutting wheel or pipe cutters
 PL Zapasowe kółko tnące do obcinaka do rur
 DE Ersatzschneidrad für Rohrschneider
 RU Запасной режущий диск для труборезов
 CZ Náhradní fezné kolečko na trubky frézy
 HU Tartalék vágókerék cső vágó
 RO Roata de schimb pt. taiere tevi
 FR Molette pour coupe
 IT Ruota di ricambio per tagliatubi
 ES Rueda de corte de repuesto para cortatubos
 CN 管子割刀刀片

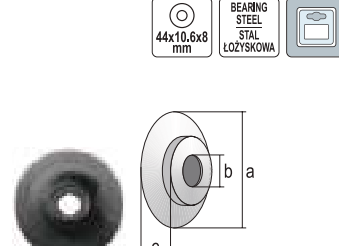

44x10.6x8 mm
 BEARING STEEL STAL ŁOŻYSKOWA

YATO	a [mm]	b [mm]	c [mm]	For / Dla	
YT-22313	18	6.0	4.8	YT-2233	50/300
YT-22314	26	14.0	7.5	YT-2232	6/108
YT-22315	18	6.0	4.8	YT-22338	50/300
YT-22316	27	6.3	5.0	YT-2234	24/288

YATO	a [mm]	b [mm]	c [mm]	For / Dla	
YT-22317	44	10.6	8	YT-2235	12/144

EN Replacement cutting wheel for pipe cutters
 PL Zapasowe kółko tnące do obcinaka do rur
 DE Ersatzschneidrad für Rohrschneider
 RU Запасной режущий диск для труборезов
 CZ Náhradní fezné kolečko na trubky frézy
 HU Tartalék vágókerék cső vágó
 RO Roata de schimb pt. taiere tevi
 FR Molette de rechange pour coupe-tube
 IT Ruota di ricambio per tagliatubi
 ES Rueda de corte de repuesto para cortatubos
 CN 管子割刀刀片

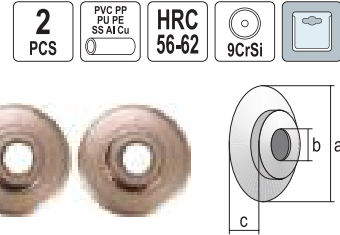

2 PCS
 PVC PP PU PE SS Al Cu
 HRC 56-62
 9CrSi

EN Replacement cutting wheel for pipe cutters
 PL Zapasowe kółko tnące do obcinaka do rur
 DE Ersatzschneidrad für Rohrschneider
 RU Запасной режущий диск для труборезов
 CZ Náhradní fezné kolečko na trubky frézy
 HU Tartalék vágókerék cső vágó
 RO Roata de schimb pt. taiere tevi
 FR Molette de rechange pour coupe-tube
 IT Ruota di ricambio per tagliatubi
 ES Rueda de corte de repuesto para cortatubos
 CN 管子割刀刀片

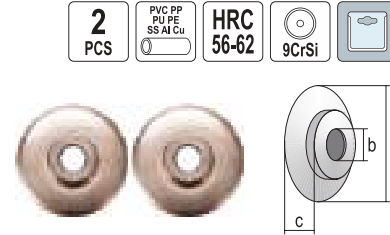

2 PCS
 PVC PP PU PE SS Al Cu
 HRC 56-62
 9CrSi

YATO	a [mm]	b [mm]	c [mm]	For / Dla	
YT-22343	18.5	6	4.8	YT-22341, YT-22342	24/144

YATO	a [mm]	b [mm]	c [mm]	For / Dla	
YT-22345	21.5	6	4.9	YT-22344	24/144

EN Standard two handed bender
 PL Giętarka do rur
 DE Standard-Zweihand-Bieger
 RU Стандартный двуручный трубогиб
 CZ Dvouruční ohývačka cu trubek
 HU Kétkézes hajlító
 RO Dispozitiv de indoit teava
 FR Cintreuse à tubes manuelle
 IT Curvatubi manuale
 ES Curvadora de tubo manual
 CN 弯管器

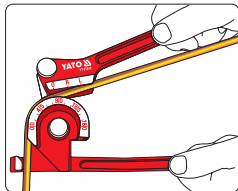

180°
 1/4" 6.3mm
 5/16" 8mm
 3/8" 9.5mm



YATO	Pipe diameter / Średnica rury	
YT-21840	1/4" (6.3 mm), 5/16" (8 mm), 3/8" (10 mm)	20

EN Standard two handed bender
 PL Giętarka do rur
 DE Standard-Zweihand-Bieger
 RU Стандартный двуручный трубогиб
 CZ Dvouruční ohývačka cu trubek
 HU Kétkézes hajlító
 RO Dispozitiv de indoit teava
 FR Cintreuse à tubes manuelle
 IT Curvatubi manuale
 ES Curvadora de tubo manual
 CN 弯管器

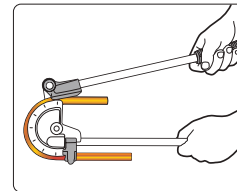

180°
 Al Cu
 SOFT STEEL BRASS MESSING STAL BRONZA



YATO	Pipe diameter / Średnica rury	
YT-21842	15/32" (12 mm)	20
YT-21844	9/32" (15 mm)	10
YT-21845	5/8" (16 mm)	10
YT-21846	23/32" (18 mm)	10

EN Pipe bender set
 PL Giętarka do rur
 DE Rohrbiegeset
 RU Трубогиб ручной механический
 CZ Ruční ohývačka trubek
 HU Csőhajlító
 RO Set de indoit tevi
 FR Cintreuse de tuyaux
 IT Curvatubi manuale
 ES Dobladora de tubos
 CN 弯管器



6-22 mm

YATO	Pipe diameter / Średnica rury [mm]	
YT-21847	6, 8, 10, 12, 16, 19, 22	4

EN Internal pipe bending spring
PL Sprężyna wewnętrzna do gięcia rur
DE Innen-Rohrbiegefeder
RU Пружина внутренняя для изгиба металлопластиковых труб

CZ Pružina pro ohýbání trubek vnitřní
HU Belső cső hajlító rugó
RO Arc indoire pt. tevi flexibile
FR Ressort à cintrer intérieur

IT Molla piegatubi interna
ES Muelle curvatubos interior
CN 弹簧弯管器

760 mm

PEX

ZINC PLATED
OCYNKOWANA

FLAT PROFILE
PLASKI PROFIL

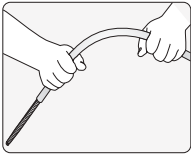

YATO	Pipe internal diameter / Wewnętrzna średnica rury [mm]	
YT-21850	16	25
YT-21851	20	25
YT-21852	25-26	25

EN External pipe bending spring
PL Sprężyna zewnętrzna do gięcia rur
DE Außen-Rohrbiegefeder
RU Пружина наружная для изгиба труб

CZ Pružina pro ohýbání trubek vnější
HU Csőhajlító rugó külső
RO Arc exterior de Indoire a țevii
FR Ressort à cintrer extérieur pour tube

IT Molla piegatubi esterna
ES Muelle curvatubos exterior
CN 弯管弹簧

600 mm

PEX

ZINC PLATED
OCYNKOWANA

FLAT PROFILE
PLASKI PROFIL



YATO	Pipe external diameter / Zewnętrzna średnica rury [mm]	
YT-21855	16	40
YT-21856	20	40
YT-21857	25-26	20

EN Line set for bending pipes
PL Zestaw prętów do gięcia rur
DE Rohrbiegestab-Set
RU Набор стержней для гибки труб
CZ Sada tyčí pro ohýbání trubek
HU Csőhajlító rúdkészlet
RO Set dispozitive pt. lățirea țevilor
FR Jeu de tiges à cintrer pour courber tubes
IT Set di aste per piegatura tubi
ES Kit doblatubos
CN 塑胶棒

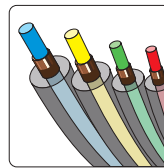

4 PCS

4m

4.0 mm

6.0 mm

9.0 mm

12 mm

PE



YATO	Pipe diameter / Średnica rury	
YT-21860	1/4", 3/8", 1/2", 5/8"	10

EN Tube flaring tool
PL Kielicharka do ręcznego rozszerzania rur
DE Handpresse zum Aufweiten von Rohren
RU Пресс для ручного расширения труб
CZ Přípravek na ruční rozšiřování konců trubek
HU Kézi csőtágító készlet
RO Presă manuală pt. lățirea țevilor
FR Set pour étendre les tubes
IT Attrezzi per svasatura di tubi
ES Abocinador manual para tubos
CN 扩孔器组套

22-28 mm

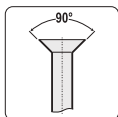

YATO	Pipe diameter / Średnica rury [mm]	
YT-2182	22, 25, 28	20

EN Tube flaring tool
PL Kielicharka do ręcznego rozszerzania rur
DE Handpresse zum Aufweiten von Rohren
RU Пресс для ручного расширения труб
CZ Přípravek na ruční rozšiřování konců trubek
HU Kézi csőtágító készlet
RO Presă manuală pt. lățirea țevilor
FR Set pour étendre les tubes
IT Attrezzi per svasatura di tubi
ES Abocinador manual para tubos
CN 扩孔器组套

5-19 mm

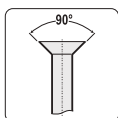

YATO	Pipe diameter / Średnica rury [mm]	
YT-21802	5, 6, 8, 10, 12, 16, 19	10

EN Tube flaring tool
PL Kielicharka do ręcznego rozszerzania rur
DE Handpresse zum Aufweiten von Rohren
RU Пресс для ручного расширения труб
CZ Přípravek na ruční rozšiřování konců trubek
HU Kézi csőtágító készlet
RO Presă manuală pt. lățirea țevilor
FR Set pour étendre les tubes
IT Attrezzi per svasatura di tubi
ES Abocinador manual para tubos
CN 扩孔器组套

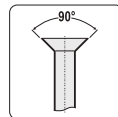

7 PCS

3-19 mm



YATO	Pipe diameter / Średnica rury [mm]	
YT-2180	3, 5, 6, 8, 10, 12, 14, 15, 16, 19	10

EN Manual tube expander
PL Ekspander ręczny do rur
DE Manueller Rohrexpander
RU Расширитель-экспандер для труб
CZ Ruční expanďer na trubky
HU Kézi csőtágító
RO Dispozitiv manual pt. bercurit tevi
FR Extenseur de tube manuel
IT Espansore manuale per tubi
ES Expansor manual de tubos
CN 扩孔器

1/4"

5/16"

3/8"

1/2"

6.3mm

8 mm

9.5 mm

12.7 mm

5/8"

3/4"

7/8"

15.9 mm

19 mm

22.2 mm



YATO	Pipe diameter / Średnica rury	
YT-21805	1/4" (6.3 mm), 5/16" (8 mm), 3/8" (9.5 mm), 1/2" (12.7 mm), 5/8" (15.9 mm), 3/4" (19.0 mm), 7/8" (22.2 mm)	10/40

EN Lever tube expander
 PL Ekspander ręczny do rur
 DE Manuelle Rohraufweiter
 RU Расширитель-эспандер для труб
 CZ Ruční expandér na trubky
 HU Kézi csőtágító

RO Dispozitiv cu parghie pt. bercuit tevi
 FR Extenseur de tube à levier
 IT Espansore manuale per tubi
 ES Expansor manual de tubos
 CN 杠杆式胀管器

∅3/8" 9.5 mm	∅1/2" 12.7 mm	∅5/8" 16 mm
∅3/4" 19 mm	∅7/8" 22.2 mm	∅1" 25 mm
∅1 1/8" 28.6 mm		

EN Hydraulic tube expander
 PL Ekspander hydrauliczny do rur
 DE Hydraulischer Rohrexpander
 RU Ручной гидравлический расширитель труб
 CZ Hydraulický expandér trubek
 HU Hidraulikus csőtágító

RO Dispozitiv hidraulic pt. bercuit tevi
 FR Extenseur de tube hydraulique
 IT Espansore idraulico per tubi
 ES Expansor hidráulico de tubos
 CN 液压胀管器

∅3/8" 9.5 mm	∅1/2" 12.7 mm	∅5/8" 16 mm
∅3/4" 19 mm	∅7/8" 22.2 mm	∅1" 25 mm
∅1 1/8" 28.6 mm		



YATO	Pipe diameter / Średnica rury	
YT-21825	3/8" (9.5 mm), 1/2" (12.7 mm), 5/8" (15.9 mm), 3/4" (19.0 mm), 7/8" (22.2 mm), 1" (25.4 mm), 1-1/8" (28.6 mm)	4

YATO	Pipe diameter / Średnica rury	
YT-21826	3/8" (9.5 mm), 1/2" (12.7 mm), 5/8" (15.9 mm), 3/4" (19.0 mm), 7/8" (22.2 mm), 1" (25.4 mm), 1-1/8" (28.6 mm)	4

EN Pipe calibration tool with reamer
 PL Kalibrator z gratownikiem
 DE Kalibrierer und Entgräter für Mehrschichtverbundrohr
 RU Калибратор для труб с фаскоснимателем
 CZ Kalibrátor s odhrotovačem pro trubku
 HU Csőkalibráló sorjázóval
 RO Calibrator teava cu debavurator
 FR Calibreur ébavureur pour tube multicouche
 IT Calibratore sbavatore per tubo
 ES Desbarbador y calibrador para tubos
 CN 三脚内外倒角整圆器





EN Pipe calibration tool with reamer
 PL Kalibrator z gratownikiem
 DE Kalibrierer und Entgräter für Mehrschichtverbundrohr
 RU Калибратор для труб с фаскоснимателем
 CZ Kalibrátor s odhrotovačem pro trubku
 HU Csőkalibráló sorjázóval
 RO Calibrator teava cu debavurator
 FR Calibreur ébavureur pour tube multicouche
 IT Calibratore sbavatore per tubo
 ES Desbarbador y calibrador para tubos
 CN 整圆倒角器



EN Pipe calibration tool
 PL Kalibrator do rur
 DE Kalibrierer für Mehrschichtverbundrohr
 RU Калибратор для труб
 CZ Kalibrátor pro trubku
 HU Csőkalibráló
 RO Calibrator teava multistrat
 FR Outil de calibrage pour tube multicouche
 IT Calibratore per tubo
 ES Calibrador para tubos multicapa
 CN 整圆器



YATO	Pipe external diameter / Zewnętrzna średnica rury [mm]	
YT-22373	16, 20, 25	200
YT-22374	16, 20, 26	200

YATO	Pipe external diameter / Zewnętrzna średnica rury [mm]	
YT-22375	16	10/40
YT-22376	20	10/40
YT-22377	25, 26	10/40

YATO	Pipe external diameter / Zewnętrzna średnica rury [mm]	
YT-22378	16, 18, 20, 25, 32	10/40

EN Plastic pipe welder
 PL Zgrzewarka do rur termoplastycznych
 DE Schweissgerät für thermoplastische Rohre
 RU Аппарат для сварки пластиковых труб
 CZ Svářečka na termoplastické trubky
 HU Hegesztő berendezés termoplasztikus csövekhez

RO Masina de sudat tevi termoplastice
 FR Machine à souder pour tuyaux
 IT Polifusore saldatore per tubi plastica
 ES Máquina de soldadura de tubos de plástico
 CN 热熔器



EN Plastic pipe welder
 PL Zgrzewarka do rur termoplastycznych
 DE Schweissgerät für thermoplastische Rohre
 RU Аппарат для сварки пластиковых труб
 CZ Svářečka na termoplastické trubky
 HU Hegesztő berendezés termoplasztikus csövekhez

RO Masina de sudat tevi termoplastice
 FR Machine à souder pour tuyaux
 IT Polifusore saldatore per tubi plastica
 ES Máquina de soldadura de tubos de plástico
 CN 热熔器

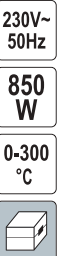

∅ 16, 20, 25, 32 mm

∅ 16, 20, 25, 32, 40, 50, 63 mm

YATO	[W]	
YT-82251	800	10

YATO	[W]	
YT-82250	850	2

EN Crimping pliers for PEX-AL-PEX pipes
PL Praska do zaciskania złączek PEX-AL-PEX
DE Rohrpresszange PEX-AL-PEX
RU Пресс-клещи для металлопластиковых труб
CZ Lisovací kleště pro trubky PEX-AL-PEX
HU PEX-AL-PEX krimpelő eszköz
RO Clește de sertizare pt. țevi PEX-AL-PEX
FR Pince à sertir tuyaux PEX-AL-PEX
IT Crimpatrice per tubi PEX-AL-PEX
ES Alicates prensadores de tuberías PEX-AL-PEX
CN 手动压管钳



9 PCS	PEX 	U 16mm	U 20mm
U 25mm	U 32mm	6t 60 kN	TH 16mm
TH 20mm	TH 26mm	TH 32mm	



YATO
YT-21755 2

EN Crimping pliers for PEX-AL-PEX pipes
PL Praska do zaciskania złączek PEX-AL-PEX
DE Rohrpresszange PEX-AL-PEX
RU Пресс-клещи для металлопластиковых труб
CZ Lisovací kleště pro trubky PEX-AL-PEX
HU PEX-AL-PEX krimpelő eszköz
RO Clește de sertizare pt. țevi PEX-AL-PEX
FR Pince à sertir tuyaux PEX-AL-PEX
IT Crimpatrice per tubi PEX-AL-PEX
ES Alicates prensadores de tuberías PEX-AL-PEX
CN 手动压管钳



9 PCS	PEX 	U 16mm	U 20mm
U 25mm	U 32mm	TH 16mm	TH 20mm
TH 26mm	TH 32mm	10t	



YATO
YT-21758 4

EN Crimping pliers for PEX-AL-PEX pipes
PL Praska do zaciskania złączek PEX-AL-PEX
DE Rohrpresszange PEX-AL-PEX
RU Пресс-клещи для металлопластиковых труб
CZ Lisovací kleště pro trubky PEX-AL-PEX
HU PEX-AL-PEX krimpelő eszköz
RO Clește de sertizare pt. țevi PEX-AL-PEX
FR Pince à sertir tuyaux PEX-AL-PEX
IT Crimpatrice per tubi PEX-AL-PEX
ES Alicates prensadores de tuberías PEX-AL-PEX
CN 手动压管钳



9 PCS	PEX 	U 16mm	U 20mm
U 25mm	U 32mm	TH 16mm	TH 20mm
TH 26mm	TH 32mm	10t	360°



YATO
YT-21759 2

EN Crimping pliers for PEX-AL-PEX pipes
PL Praska do zaciskania złączek PEX-AL-PEX
DE Rohrpresszange PEX-AL-PEX
RU Пресс-клещи для металлопластиковых труб
CZ Lisovací kleště pro trubky PEX-AL-PEX
HU PEX-AL-PEX krimpelő eszköz

RO Clește de sertizare pt. țevi PEX-AL-PEX
FR Pince à sertir tuyaux PEX-AL-PEX
IT Crimpatrice per tubi PEX-AL-PEX
ES Alicates prensadores de tuberías PEX-AL-PEX
CN 手动压管钳

4 PCS	PEX 	TH 16mm	TH 20mm	TH 26mm	
----------	---------	------------	------------	------------	--



YATO
YT-21750 4

EN Crimping pliers for PEX-AL-PEX pipes
PL Praska do zaciskania złączek PEX-AL-PEX
DE Rohrpresszange PEX-AL-PEX
RU Пресс-клещи для металлопластиковых труб
CZ Lisovací kleště pro trubky PEX-AL-PEX
HU PEX-AL-PEX krimpelő eszköz

RO Clește de sertizare pt. țevi PEX-AL-PEX
FR Pince à sertir tuyaux PEX-AL-PEX
IT Crimpatrice per tubi PEX-AL-PEX
ES Alicates prensadores de tuberías PEX-AL-PEX
CN 手动压管钳

4 PCS	PEX 	U 16mm	U 20mm	U 25mm	
----------	---------	-----------	-----------	-----------	--



YATO
YT-21751 4

EN Spare die for crimping pliers
 PL Matryca zapasowa do zaciskarki
 DE Rohrpresszange-Pressbacke
 RU Вкладыш для пресс-инструмента
 CZ Náhradní matrice pro lisovací kleště
 HU Krimpelő betét
 RO Cap de schimb pt. presă
 FR Matrice pour pince à sertir tuyaux
 IT Inserto per pinza a pressione
 ES Matriz para alicata de prensar
 CN 手动压管钳模具



For YT-21735
 Dla YT-21735

YATO	[mm]	
YT-21740	16	50
YT-21741	20	50
YT-21742	25	100
YT-21743	32	100

EN Spare die for crimping pliers
 PL Matryca zapasowa do zaciskarki
 DE Rohrpresszange-Pressbacke
 RU Вкладыш для пресс-инструмента
 CZ Náhradní matrice pro lisovací kleště
 HU Krimpelő betét
 RO Cap de schimb pt. presă
 FR Matrice pour pince à sertir tuyaux
 IT Inserto per pinza a pressione
 ES Matriz para alicata de prensar
 CN 手动压管钳模具



For YT-21750, YT-21751
 Dla YT-21750, YT-21751

YATO	[mm]	
YT-21755	16	50
YT-21756	20	50
YT-21757	25	50

EN Hinged pipe vice
 PL Imadło zaciskowe do rur
 DE Rohrschraubstock
 RU Тиски для труб
 CZ Upínací svěrák na trubky
 HU Satu, csészorító
 RO Menghină pt. țevi
 FR Étau de serrage à tuyaux
 IT Morsa stringi tubo
 ES Tornillo de aprite para tubos
 CN 管子台虎钳



YATO	Max. mounting element diameter / Maks. średnica mocowanego elementu [mm]	
YT-6510	60	4
YT-6511	76	2
YT-6512	90	2
YT-6513	110	1

EN Water pressure gauge
 PL Zestaw do kontroli ciśnienia instalacji wodnej
 DE Druckmessgerät für Wasserinstallationen
 RU Набор для контроля давления в установках воды
 CZ Sada pro kontrolu tlaku vodovodní instalace
 HU Viznyomásmérő óra
 RO Manometru presiune apa
 FR Kit de contrôle de la pression du système sanitaire
 IT Set per controllo di pressione nell'impianto idrico
 ES Kit para el control de presión en la instalación de agua
 CN 水压表



YATO	
YT-24790	10/80

EN Spare die for crimping pliers
 PL Matryca zapasowa do zaciskarki
 DE Rohrpresszange-Pressbacke
 RU Вкладыш для пресс-инструмента
 CZ Náhradní matrice pro lisovací kleště
 HU Krimpelő betét
 RO Cap de schimb pt. presă
 FR Matrice pour pince à sertir tuyaux
 IT Inserto per pinza a pressione
 ES Matriz para alicata de prensar
 CN 手动压管钳模具



For YT-21735
 Dla YT-21735

YATO	[mm]	
YT-21744	16	50
YT-21745	20	50
YT-21746	26	50
YT-21747	32	100

EN Spare die for crimping pliers
 PL Matryca zapasowa do zaciskarki
 DE Rohrpresszange-Pressbacke
 RU Вкладыш для пресс-инструмента
 CZ Náhradní matrice pro lisovací kleště
 HU Krimpelő betét
 RO Cap de schimb pt. presă
 FR Matrice pour pince à sertir tuyaux
 IT Inserto per pinza a pressione
 ES Matriz para alicata de prensar
 CN 手动压管钳模具



For YT-21750, YT-21751
 Dla YT-21750, YT-21751

YATO	[mm]	
YT-21752	16	50
YT-21753	20	50
YT-21754	26	50

EN Thread seal string
 PL Nić do uszczelniania gwintów
 DE Gewindedichtfaden
 RU Уплотнительная нить
 CZ Těsnící vlákno na závity
 HU Menetítőmítő zsinór
 RO Snur de etansare conducte si filete
 FR Tuyau étanchéité cordon
 IT Filo sigillafi letti
 ES Hilo sellador
 CN 螺纹密封线



YATO	L [m]	
YT-29220	50	25/100

EN Thread seal string
 PL Nić do uszczelniania gwintów
 DE Gewindedichtfaden
 RU Уплотнительная нить
 CZ Těsnící vlákno na závity
 HU Menetítőmítő zsinór
 RO Snur de etansare conducte si filete
 FR Tuyau étanchéité cordon
 IT Filo sigillafi letti
 ES Hilo sellador
 CN 螺纹密封线

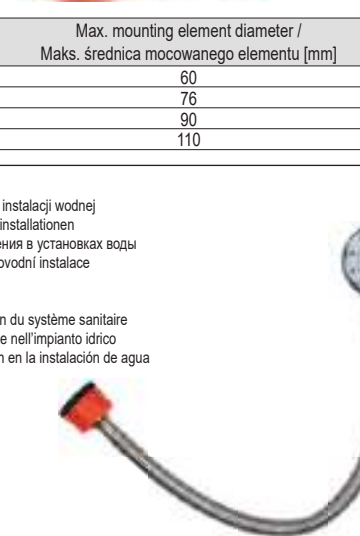

YATO	L [m]	
YT-29222	150	25/100

EN Radiator bleed key
 PL Kluczyk do odpowietrzania grzejników
 DE Heizkörper-Entlüftungsschlüssel
 RU Ключ для радиаторов
 CZ Klíč na odvzdušnění radiátorů
 HU Radiátor légtelenítő kulcs
 RO Cheie aerisit radiator
 FR Clé de purge pour radiateur
 IT Chiave per spurgo termosifoni
 ES Llave para purgar radiadores
 CN 排气钥匙



PIPE DIAMETER / ŚREDNICA RURY	CYCLE NUMBER / ILOŚĆ ZWIĄZÓW
1/2" (12.5 mm)	6-8
3/4" (19 mm)	7-9
1" (25 mm)	8-12
1 1/2" (38 mm)	10-15
2" (50 mm)	15-25
2 1/2" (63 mm)	20-35
3" (75 mm)	25-35
3 1/2" (88 mm)	30-40
4" (100 mm)	35-45

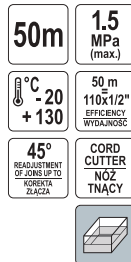

YATO	L [m]	
YT-29220	50	25/100

EN Radiator bleed key
 PL Kluczyk do odpowietrzania grzejników
 DE Heizkörper-Entlüftungsschlüssel
 RU Ключ для радиаторов
 CZ Klíč na odvzdušnění radiátorů
 HU Radiátor légtelenítő kulcs
 RO Cheie aerisit radiator
 FR Clé de purge pour radiateur
 IT Chiave per spurgo termosifoni
 ES Llave para purgar radiadores
 CN 排气钥匙



PIPE DIAMETER / ŚREDNICA RURY	CYCLE NUMBER / ILOŚĆ ZWIĄZÓW
1/2" (12.5 mm)	6-8
3/4" (19 mm)	7-9
1" (25 mm)	8-12
1 1/2" (38 mm)	10-15
2" (50 mm)	15-25
2 1/2" (63 mm)	20-35
3" (75 mm)	25-35
3 1/2" (88 mm)	30-40
4" (100 mm)	35-45



YATO	L [m]	
YT-29222	150	25/100

EN Radiator bleed key
 PL Kluczyk do odpowietrzania grzejników
 DE Heizkörper-Entlüftungsschlüssel
 RU Ключ для радиаторов
 CZ Klíč na odvzdušnění radiátorů
 HU Radiátor légtelenítő kulcs
 RO Cheie aerisit radiator
 FR Clé de purge pour radiateur
 IT Chiave per spurgo termosifoni
 ES Llave para purgar radiadores
 CN 排气钥匙

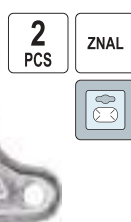

YATO	
YT-21991	24/144

EN Hand pressure test pump
PL Pompa ręczna do prób ciśnieniowych
DE Handpumpe für Druckproben
RU Ручной насос для опрессовки
CZ Ruční čerpadlo pro tlakové testování
HU Kézi nyomáspróba szivattyú
RO Pompa manuala testat presiunea
FR Pompe manuelle pour tests de pression
IT Pompa manuale per prove di pressione
ES Bomba manual para pruebas de presión
CN 试压泵

490x160
x165 mm

12L

0-5 MPa

G1/2



YATO	Tank capacity / Pojemność zbiornika [l]	
YT-24800	12	2

EN External chamfer tool
PL Gratownik zewnętrzny
DE Außenentgrater
RU Гратосниматель наружный для труб
CZ Přípravěk na odstraňování ořepů
HU Kúlső sorjázó
RO Dispozitiv de țesire extern pt. debavurare
FR Ébavureur extérieur
IT Sbavatore esterno
ES Desbarbador exterior
CN 外圆倒角器



∅ 3-19 mm

12 ↑ mm

1/4"

6.3 mm

YG8



YATO	∅ [mm]	
YT-22357	3-19	10/80



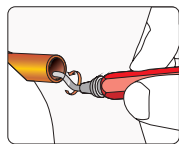





EN Deburrer
PL Gratownik
DE Entgrater
RU Гратосниматель
CZ Odhrotovač
HU Sorjázó
RO Debavurator
FR Ébavureur
IT Sbavatore
ES Desbarbador
CN 修边器



∅ 12 mm

HSS M2

CHANGEABLE ROTATING BLADE
WYMIENNE OSTRZE
OBROTOWE

YATO	
YT-22360	50/150

EN Pipe deburrer
PL Gratownik do rur
DE Rohrentgrater
RU Гратосниматель для труб
CZ Odhrotovač trubek
HU Sorjázó
RO Debavurator pt. tevi
FR Ébavureur de tuyaux
IT Sbavatore per tubi
ES Desbarbador de tubos
CN 修边器



∅ 4-40 mm

65Mn

ZNAL



YATO	∅ [mm]	
YT-22364	4-40	64

EN Hand pressure test pump
PL Pompa ręczna do prób ciśnieniowych
DE Handpumpe für Druckproben
RU Ручной насос для опрессовки
CZ Ruční čerpadlo pro tlakové testování
HU Kézi nyomáspróba szivattyú
RO Pompa manuala testat presiunea
FR Pompe manuelle pour tests de pression
IT Pompa manuale per prove di pressione
ES Bomba manual para pruebas de presión
CN 试压泵

7L

0-5 MPa

G1/2



YATO	Tank capacity / Pojemność zbiornika [l]	
YT-24801	7	2

EN Pipe deburrer
PL Gratownik do rur
DE Rohrentgrater
RU Гратосниматель для труб
CZ Odhrotovač trubek
HU Sorjázó
RO Debavurator pt. tevi
FR Ébavureur de tuyaux
IT Sbavatore per tubi
ES Desbarbador de tubos
CN 修边器



PVC PP
PU PE
SS Al Cu

∅ 6-36 mm



YATO	∅ [mm]	
YT-22365	6-36	80



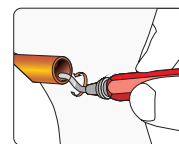





EN Deburrer
PL Gratownik
DE Entgrater
RU Гратосниматель
CZ Odhrotovač
HU Sorjázó
RO Debavurator
FR Ébavureur
IT Sbavatore
ES Desbarbador
CN 修边器



6 PCS

HSS M2

CHANGEABLE ROTATING BLADE
WYMIENNE OSTRZE
OBROTOWE

YATO	
YT-22363	50/100







EN Replacement blade for deburrer
PL Ostrza zapasowe do gratownika
DE Ersatzklinge für Entgrater
RU Лезвие для снятия заусенцев
CZ Náhradní čepel pro odjehlování
HU Tartalék penge sorjázásához
RO Lame rezerva pt. debavurator
FR Set le lames pour ébavureur
IT Set di lame per sbavatore
ES Cuchilla de repuesto para desbarbar
CN 修边器刀片

10 PCS

HSS M2

UNIVERSAL SHAPE
UNIVERSÁLNY KŠZTALT

CHANGEABLE ROTATING BLADE
WYMIENNE OSTRZE
OBROTOWE

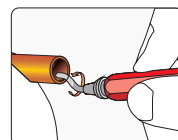
For YT-22360
Dla YT-22360

YATO	
YT-22361	12/144

EN Copper pipe internal brush
 PL Szczotka wewnętrzna do rur miedzianych
 DE Kupferrohr Innenbürste
 RU Щетка для внутренней очистки труб
 CZ Kartáč vnitřní na měděné trubky
 HU Rézcső belső tisztító kefe
 RO Perii de interior pt. tevi de cupru
 FR Brosse aux tubes en cuivre
 IT Spazzola per il rame interno
 ES Cepillo para limpieza de tubos de cobre
 CN 管子刷



YATO	Pipe internal diameter / Wewnętrzna średnica rury [mm]	
YT-63701	15	12/240
YT-63702	18	12/240
YT-63703	22	12/240
YT-63704	28	12/240

EN Copper pipe brush 2 in 1
 PL Szczotka do rur miedzianych 2 w 1
 DE 2 in 1 Kupferrohrbürste für Innen- und Außenreinigung
 RU Щетка для внутренней и внешней зачистки медных труб
 CZ Kartáč vnitřní a vnější na měděné trubky
 HU Rézcső tisztító kefe 2 in 1
 RO Perii pt. tevi de cupru 2 in 1
 FR Brosse aux tubes en cuivre
 IT Spazzola per il tubi di rame 2 in 1
 ES 2 en 1 cepillo para limpieza de tubos de cobre int. y ext
 CN 管子刷



YATO	Pipe external & internal diameter / Zewnętrzna i wewnętrzna średnica rury [mm]	
YT-63705	15, 22	50/100

EN Cleaning pad set for copper pipes
 PL Włókna do czyszczenia rur miedzianych
 DE Reinigungsvlies-Satz für Kupferrohre
 RU Губка абразивная
 CZ Brusné rouno
 HU Tisztítószivacs
 RO Burete abraziv
 FR Tampons de nettoyage
 IT Fibra abrasiva
 per la pulizia di tubo di rame
 ES Almohadilla abrasiva
 CN 百洁布

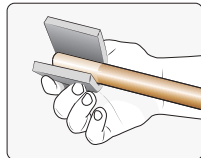

YATO	Size / Rozmiar [mm]	
YT-63740	75x130	50

EN Drain suction pump
 PL Pompa do udrażniania kanalizacji
 DE Rohrreinigungspumpe
 RU Пневматический вантус для прочистки труб
 CZ Čerpadlo na čistění trubek
 HU Lefolyótisztító pumpa
 RO Pompă pt. curățarea țevilor
 FR Déboucheur à pompe à vide
 IT Pompa sturaturi
 ES Desatascador bomba de vacío
 CN 气筒疏通器



YATO		
YT-25030		4

EN Drain auger
 PL Spirala kanalizacyjna
 DE Hand-Rohrreinigungsspirale
 RU Трос для прочистки канализационных труб и каналов
 CZ Spirála na čistění trubek
 HU Csőtisztító spirál
 RO Dedeman cablu pt. desfundat canale
 FR Câble de nettoyage de tuyaux pour les mains
 IT Sturafogne a molla spirale
 ES Varilla para limpiar drenajes
 CN 管道疏通器



YATO	Ø [mm]	L [m]	
YT-24990	6x1.3	6	12

EN Drain auger
 PL Spirala kanalizacyjna
 DE Hand-Rohrreinigungsspirale
 RU Трос для прочистки канализационных труб и каналов
 CZ Spirála na čistění trubek
 HU Csőtisztító spirál
 RO Dedeman cablu pt. desfundat canale
 FR Câble de nettoyage de tuyaux pour les mains
 IT Sturafogne a molla spirale
 ES Varilla para limpiar drenajes
 CN 管道疏通器



YATO	Ø [mm]	L [m]	
YT-24991	6x1.3	7.6	8

EN Drain auger
 PL Spirala kanalizacyjna
 DE Hand-Rohrreinigungsspirale
 RU Трос для прочистки канализационных труб и каналов
 CZ Spirála na čistění trubek
 HU Csőtisztító spirál

RO Sarpe pt. desfundat țevi
 FR Câble de nettoyage de tuyaux pour les mains
 IT Sturafogne a molla spirale
 ES Varilla para limpiar drenajes
 CN 管道疏通器



YATO	Ø [mm]	L [m]	
YT-25000	5x1.5	1.5	30/60
YT-25001	5x1.5	3.0	40
YT-25002	6x1.3	3.0	40
YT-25003	6x1.3	5.0	20
YT-25004	9x1.7	5.0	10
YT-25005	9x1.7	10.0	6

EN Toilet auger
 PL Przetakacz do toalet
 DE Abflusstamper
 RU Средство от засорения унитаза
 CZ Čistič toalet
 HU Duguláshárító
 RO Dispozitiv pt. desfundat toaleta
 FR Ustensile pour déboucher les toilettes
 IT Stura WC
 ES Sonda destapadora wc
 CN 疏通器

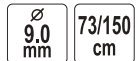

YATO	Ø [mm]	L [cm]	
YT-24983	9	150	6

EN Drain rod set
PL Zestaw prętów do udrażniania kanalizacji
DE Abflusstreinigungsstangen-Set
RU Прутья для прочистки канализационных труб
CZ Pruty k čištění kanalizace sada
HU Csőtisztító rúdkészlet
RO Accesorii pt. dispozitiv desfundat revii
FR Tiges pour déboucher les canalisations
IT Kit di barre per lo sturamento della rete fognaria
ES Varillas de alcantarillado, juego
CN 疏通器



12
PCS

20
mm

9.2m

10x93.2
cm

PP



YATO
YT-24980

8

EN Brush for drain cleaning
PL Szczotka do udrażniania kanalizacji
DE Abflussbürste
RU Щетка для прочистки канализационных труб
CZ Štětka k čištění kanalizace
HU Csőtisztító kefe
RO Perie pt. curățarea scurgerilor
FR Brosse pour déboucher les canalisations
IT Spazzola per lo sturamento della rete fognaria
ES Cepillo de alcantarillado
CN 疏通器刷头



For YT-24980
Dla YT-24980

YATO	Ø [mm]	
YT-24970	100	20/40
YT-24971	200	20/40
YT-24972	250	20/40

EN Double worm for drain cleaning
PL Końcówka spiralna do udrażniania kanalizacji
DE Doppelschnecke für Abflusstreinigung
RU Спиральный наконечник для прочистки канализационных труб
CZ Spirálová koncovka k čištění kanalizace
HU Csőtisztító dupla meletes csavar
RO Cap spiral dublu pt. curățarea scurgerilor
FR Extrémité en spirale pour déboucher les canalisations
IT Testa spirale per lo sturamento della rete fognaria
ES Tubo espiral de drenaje
CN 疏通器绕钩

165x7
mm

ZINC
PLATED
OCYNKO-
WANA



For YT-24980
Dla YT-24980

YATO	Size / Rozmiar [mm]	
YT-24963	165x7	24/96

EN Plunger for drain cleaning
PL Tłok okrągły do udrażniania kanalizacji
DE Gummi-Saugteller für Abflusstreinigung
RU Крутящий шток для прочистки канализационных труб
CZ Kulatý pist k čištění kanalizace
HU Csőtisztító gumipumpa
RO Pompă pt. curățarea scurgerilor
FR Piston pour déboucher les canalisations
IT Pistone tondo per lo sturamento della rete fognaria
ES Embolo redondo de drenaje
CN 橡胶吸盘

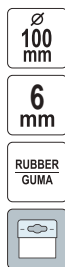

For YT-24980
Dla YT-24980

YATO	Ø [mm]	
YT-24960	100	24/96

EN Scraper for drain cleaning
PL Skrobak opadowy do udrażniania kanalizacji
DE Klappschaber für Abflusstreinigung
RU Проходной скребок для прочистки канализационных труб
CZ Odpadová škrabka k čištění kanalizace
HU Csőtisztító kaparó
RO Račetă pt. curățarea scurgerilor
FR Grattoir pour déboucher les canalisations
IT Raschietto gravitazionale per lo sturamento della rete fognaria
ES Rasqueta articulada de alcantarillado
CN 疏通器耙头



For YT-24980
Dla YT-24980

YATO	Size / Rozmiar [mm]	
YT-24965	95x1.5	20/100

EN Guide wheel for drain cleaning
PL Kółko prowadzące do udrażniania kanalizacji
DE Leitrad für Abflusstreinigung
RU Ведущее колесо для прочистки канализационных труб
CZ Naváděcí kolečko k čištění kanalizace
HU Csőtisztító vezetőkerék
RO Roata ghidaj curățarea scurgerilor
FR Roue de guidage pour déboucher les canalisations
IT Anello di guida per lo sturamento della rete fognaria
ES Rueda de guía de drenaje
CN 疏通器滚轮



For YT-24980
Dla YT-24980

YATO	Ø [mm]	
YT-24966	55	20/60

12

Fastening tools
Narzędzia do łączenia



Hand riveters & accessories
Nitownice ręczne i akcesoria

256-259

Foam guns
Pistolety do pianki

262



Hand riveters

Nitownice ręczne..... 256

Hand riveting tools

Nitownice ręczne, dźwigniowe..... 257

Hand nut tools

Nitownice do nitonakrętek..... 257

Hand riveters nut column

Nitownice do nitotrzpieni..... 258

Threaded rivet nuts

Nitonakrętki..... 258

Blind rivets

Nity..... 259

Pliers for hollow expansion bolts
Zaciskarki do kołków typu Molly

259



Caulking guns

Wyciskacze do mas

262-264



Steel cable ties

Opaski metalowe

264



Cable ties

Opaski plastikowe

264



Screw, plug & nail sets

Zestawy wkrętów, kołków i gwoździ

259



Burners & soldering tools

Palniki i lutownice

265-271



Glue sticks

Wkłady klejowe

271-272



Staple guns & staples

Zszywacze i zszywki

260-261



Jigs & patterns

Wzorniki i szablony

273



Staple guns

Zszywacze..... 260

Staple removers

Rozszywacze..... 261

Staples

Zszywki..... 261

Nails

Gwoździe..... 261

EN Hand riveter
 PL Nitownica ręczna
 DE Hand-Nietzange
 RU Ручной заклепочник
 CZ Ruční nýtovačka
 HU Kézi popszegecshűző

RO Presă de nituit manuală
 FR Riveteuse manuelle
 IT Rivettatrice manuale
 ES Remachadora de mano
 CN 拉铆枪



YATO	Ø [mm]	L [mm]	
YT-3600	2.4, 3.2, 4, 4.8	280	6/24

EN Hand riveter
 PL Nitownica ręczna
 DE Hand-Nietzange
 RU Ручной заклепочник
 CZ Ruční nýtovačka
 HU Kézi popszegecshűző

RO Presă de nituit manuală
 FR Riveteuse manuelle
 IT Rivettatrice manuale
 ES Remachadora de mano
 CN 拉铆枪

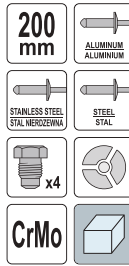

YATO	Ø [mm]	L [mm]	
YT-36012	2.4, 3.2, 4, 4.8	200	30

EN Universal hand riveter 3 in 1
 PL Nitownica ręczna uniwersalna 3 w 1
 DE Universal-Handnietzange 3 in 1
 RU Универсальный ручной заклепочник 3 в 1
 CZ Univerzální nýtovací kleště 3 v 1
 HU 3 az 1-ben univerzális kézi popszegecseelő

RO Cleste pop nit universal 3 in 1
 FR Riveteuse manuelle universelle 3 en 1
 IT Rivettatrice manuale universale 3 in 1
 ES Remachadora manual universal 3 en 1
 CN 三合一拉铆枪



YATO	Ø [mm]	Ø	L [mm]	
YT-36013	2.4, 3.2, 4, 4.8	M3, M4, M5, M6	275	8

EN Hand riveter
 PL Nitownica ręczna
 DE Hand-Nietzange
 RU Ручной заклепочник
 CZ Ruční nýtovačka
 HU Kézi popszegecshűző
 RO Presă de nituit manuală
 FR Riveteuse manuelle
 IT Rivettatrice manuale
 ES Remachadora de mano
 CN 手动拉铆枪

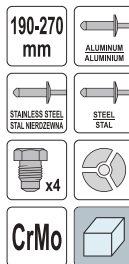

YATO	Ø [mm]	L [mm]	
YT-36070	2.4, 3.2, 4, 4.8	190-270	20

EN Rivet for plastic rivets kit
 PL Zestaw nitownica do nitów plastikowych
 DE Kunststoff-Nietzangen-Satz
 RU Комплект заклепочница для пластиковых заклепок
 CZ Sada nýtovnice do plastových nýtů
 HU Szegecshűző készlet műanyag szegecsekhez
 RO Set de nituri din plastic + cleste
 FR Ensemble riveteuse pour rivets en plastique
 IT Kit rivettatrice per rivetti in plastica
 ES Juego remachadora para remaches de plástico
 CN 拉铆枪组套



5x15.8 mm (10 PCS); 5x17.2 mm (10 PCS); 6.3x25.2 mm (10 PCS); 6.6x17.2 mm (10 PCS)

YATO	Ø [mm]	L [mm]	
YT-35970	5, 6.3, 6.6	165	10/30

EN Lazy tongue riveter
 PL Nitownica harmonijkowa czolowa
 DE Blindnietzange
 RU Передний складной заклепочник
 CZ Nýtovačka harmoniková čelná
 HU Harmóniás popszegecshűző homlok

RO Presă de nituit armonică - frontală
 FR Pince riveter extensible
 IT Rivettatrice pieghevole anteriore
 ES Remachadora perezoso tong
 CN 重型伸缩拉铆枪

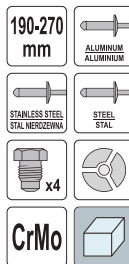

YATO	Ø [mm]	L [mm]	
YT-36060	2.4, 3.2, 4, 4.8, 6.4	250-810	10

EN Hand riveter 3 in 1
PL Nitownica dźwigniowa uniwersalna 3 w 1
DE Universal-Hebelnietzange 3 in 1
RU Заклепочник рычажный 3 в 1
CZ Univerzální pákové nýtovací kleště 3 v 1
HU 3 az 1-ben univerzális popszegecselő
RO Clește popnitruri 3 in 1
FR Riveteuse à levier universelle 3 en 1
IT Rivettatrice a leva universale 3 in 1
ES Remachadora universal de palanca 3 en 1
CN 拉铆枪



YATO	Ø [mm]	Ø	L [mm]	
YT-36091	2.4, 3.2, 4, 4.8, 6.4	M3, M4, M5, M6, M8, M10	260	6

EN Hand riveting tool
PL Nitownica dźwigniowa
DE Blindnietzange
RU Заклепочник рычажный
CZ Nýtovačka páková
HU Popszegecsűző

RO Nituire pârghie
FR Riveteuse à levier
IT Rivettatrice per rivetti a strappo
ES Remachadora de palanca
CN 双把手拉铆枪



YATO	Ø [mm]	L [mm]	
YT-3609	3.2, 4, 4.8, 6, 6.4	330	16

EN Hand riveting tool
PL Nitownica dźwigniowa
DE Blindnietzange
RU Заклепочник рычажный
CZ Nýtovačka páková
HU Popszegecsűző

RO Nituire pârghie
FR Riveteuse à levier
IT Rivettatrice per rivetti a strappo
ES Remachadora de palanca
CN 拉铆枪

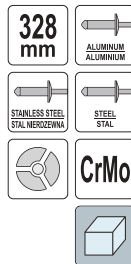

YATO	Ø [mm]	L [mm]	
YT-36092	3.2, 4, 4.8, 6.4	328	12

EN Hand riveting tool
PL Nitownica dźwigniowa
DE Blindnietzange
RU Заклепочник рычажный
CZ Nýtovačka páková
HU Popszegecsűző

RO Nituire pârghie
FR Riveteuse à levier
IT Rivettatrice per rivetti a strappo
ES Remachadora de palanca
CN 拉铆枪

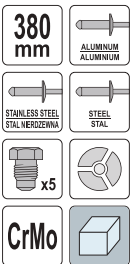

YATO	Ø [mm]	L [mm]	
YT-36095	2.4, 3.2, 4, 4.8, 6.4	380	12

EN Hand riveting tool
PL Nitownica ręczna do nitonakrętek
DE Nietmutterzange
RU Ручной заклепочник для резьбовых заклепок
CZ Nýtovací kleště na matice
HU Emelytűs popszegecsűző

RO Clește pt. piulite nituibile
FR Riveteuse manuelle aux écrous
IT Rivettatrice mano rivetto
ES Remachadora de tuercas
CN 双把手拉铆枪

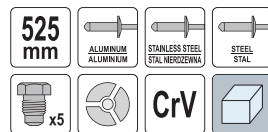

YATO	Ø [mm]	L [mm]	
YT-3610	3.2, 4, 4.8, 6, 6.4	525	12

EN Hand nut tool
PL Nitownica ręczna do nitonakrętek
DE Nietmutterzange
RU Ручной заклепочник для резьбовых заклепок
CZ Nýtovací kleště na matice
HU Emelytűs popszegecsűző

RO Clește pt. piulite nituibile
FR Riveteuse manuelle aux écrous
IT Rivettatrice mano rivetto
ES Remachadora de tuercas
CN 手动螺母枪

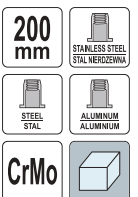

YATO	Ø	L [mm]	
YT-36140	M3, M4, M5, M6	200	20

EN Hand nut tool
PL Nitownica ręczna do nitonakrętek
DE Nietmutterzange
RU Ручной заклепочник для резьбовых заклепок
CZ Nýtovací kleště na matice
HU Emelytűs popszegecsűző

RO Clește pt. piulite nituibile
FR Riveteuse manuelle aux écrous
IT Rivettatrice mano rivetto
ES Remachadora de tuercas
CN 手动螺母枪



YATO	Ø	L [mm]	
YT-36112	M3, M4, M5, M6, M8	300	20

EN Hand nut tool
PL Nitownica ręczna do nitonakrętek
DE Nietmutterzange
RU Ручной заклепочник для резьбовых заклепок
CZ Nýtovací kleště na matice
HU Emelytűs popszegecsűző

RO Clește pt. piulite nituibile
FR Riveteuse manuelle aux écrous
IT Rivettatrice mano rivetto
ES Remachadora de tuercas
CN 双把手螺母枪



YATO	Ø	L [mm]	
YT-3612	M5, M6, M8, M10, M12	330	5

EN Hand nut tool
 PL Nitownica ręczna do nitonakrętek
 DE Nietmutterzange
 RU Ручной заклёпочник для резьбовых заклёпок
 CZ Nýtovací kleště na matice
 HU Emeltyűs popszegecshúzó

RO Clește pt. piulițe nituibile
 FR Riveteuse manuelle aux écrous
 IT Rivettatrice mano rivetto
 ES Remachadora de tuercas
 CN 柳螺母枪

338 mm

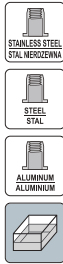

YATO	Ø	L [mm]	
YT-36119	M5, M6, M8, M10, M12	338	6

EN Hand nut tool
 PL Nitownica ręczna do nitonakrętek
 DE Nietmutterzange
 RU Ручной заклёпочник для резьбовых заклёпок
 CZ Nýtovací kleště na matice
 HU Emeltyűs popszegecshúzó

RO Clește pt. piulițe nituibile
 FR Riveteuse manuelle aux écrous
 IT Rivettatrice mano rivetto
 ES Remachadora de tuercas
 CN 轻便型双手螺母枪

360 mm



YATO	Ø	L [mm]	
YT-36127	M3, M4, M5, M6, M8, M10, M12	360	12

EN Hand nut tool
 PL Nitownica ręczna do nitonakrętek
 DE Nietmutterzange
 RU Ручной заклёпочник для резьбовых заклёпок
 CZ Nýtovací kleště na matice
 HU Emeltyűs popszegecshúzó

RO Clește pt. piulițe nituibile
 FR Riveteuse manuelle aux écrous
 IT Rivettatrice mano rivetto
 ES Remachadora de tuercas
 CN 手动螺母枪

360 mm

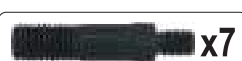

YATO	Ø	L [mm]	
YT-36128	M3, M4, M5, M6, M8, M10, M12	360	6

EN Hand nut tool
 PL Nitownica ręczna do nitonakrętek
 DE Nietmutterzange
 RU Ручной заклёпочник для резьбовых заклёпок
 CZ Nýtovací kleště na matice
 HU Emeltyűs popszegecshúzó

RO Clește pt. piulițe nituibile
 FR Riveteuse manuelle aux écrous
 IT Rivettatrice mano rivetto
 ES Remachadora de tuercas
 CN 手动柳螺母枪

420 mm

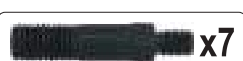
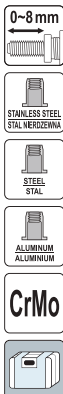

YATO	Ø	L [mm]	
YT-36125	M3, M4, M5, M6, M8, M10, M12	420	5

EN Hand nut tool
 PL Nitownica ręczna do nitonakrętek
 DE Nietmutterzange
 RU Ручной заклёпочник для резьбовых заклёпок
 CZ Nýtovací kleště na matice
 HU Emeltyűs popszegecshúzó

RO Clește pt. piulițe nituibile
 FR Riveteuse manuelle aux écrous
 IT Rivettatrice mano rivetto
 ES Remachadora de tuercas
 CN 柳螺母枪

410 mm



YATO	Ø	L [mm]	
YT-36129	M3, M4, M5, M6, M8, M10, M12	410	5

EN Hand riveter nut column set
 PL Nitownica ręczna do nitotrzpieni z akcesoriami
 DE Nietzange für Blindnieterschrauben mit Zubehör
 RU Заклёпочник для резьбовых заклёпок с принадлежностями
 CZ Ruční nýtovačka na nýtovací šrouby s příslušenstvím
 HU Kézi szegecsanya húzó tartozékokkal
 RO Set cleste piulițe nituibile
 FR Riveteuse manuelle pour boulons à rivet aveugle avec accessoires
 IT Rivettatrice manuale per perni filettati
 ES Remachadora manual para espárragos remachables con accesorios
 CN 柳螺母柱枪

46 PCS 360 mm AI CrMo



M4 (10 PCS), M5 (10 PCS), M6 (10 PCS), M8 (10 PCS)

YATO	Ø	L [mm]	
YT-36150	M4, M5, M6, M8	360	6

EN Threaded aluminum rivet nuts
 PL Nitonakrętki aluminiowe
 DE Aluminium Blindnietmutter
 RU Алюминиевые резьбовые заклёпки
 CZ Nýtovací matice hliník
 HU Szegecsanya alumínium

RO Piulițe nituibile aluminiu
 FR Insert fileté aluminium
 IT Alluminio dadi per rivetti ciechi
 ES Tuercas remachadas aluminio
 CN 拉柳螺母

20 PCS

AI



YATO	Size / Rozmiar	
YT-36451	M3	125/500
YT-36452	M4	100/400

YATO	Size / Rozmiar	
YT-36453	M5	75/300
YT-36454	M6	50/200

EN Threaded rivet nuts
 PL Nitonakrętki stalowe
 DE Blindnietmutter
 RU Резьбовые заклёпки
 CZ Nýtovací matice
 HU Szegecsanya

20 PCS



YATO	Size / Rozmiar	
YT-36470	M3	125/500
YT-36471	M4	100/400
YT-36472	M5	75/300
YT-36473	M6	50/200

YATO	Size / Rozmiar	
YT-36474	M8	35/140
YT-36475	M10	25/100
YT-36476	M12	15/60

EN Threaded rivet nuts
PL Nitonakrętki
DE Blindnietmutter
RU Резьбовые заклепки
CZ Nýtovací matice
HU Szegecsanya
RO Nituibile
FR Insert fileté
IT Dadi per rivetti ciechi
ES Tuercas remachadas
CN 拉铆螺母



150
PCS

AI



M3x40, M4x35, M5x25, M6x25, M8x15, M10x10 mm

YATO		
YT-36460	24	

150
PCS



M3x40, M4x35, M5x25, M6x25, M8x15, M10x10 mm

YATO		
YT-36481	24	

300
PCS

AI



M3x25, M4x25, M5x25, M6x25, M8x25, M10x25, M3x25, M4x25, M5x25, M6x25, M8x25, M10x25 mm

YATO		
YT-36480	5/20	

EN Nuts column
PL Nitotrzpienie
DE Blindnietverschrauben
RU Шпильки заклепки с винтом
CZ Nýtovací šrouby
HU Szegecs csavar
RO Șuruburi nituibile
FR Boulons à rivet aveugle
IT Pemi filettati
ES Espárragos remachables
CN 螺母柱

20
PCS

AI

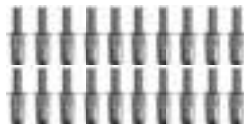

YATO	Size / Rozmiar	
YT-36200	M4	50/300
YT-36201	M5	40/160
YT-36202	M6	25/100
YT-36203	M8	15/60

EN Pliers for hollow expansion bolts
PL Zaciskarka do kołków „Molly”
DE Maueranker-Einsetzwerkzeug
RU Клещи для дюбелей „Молли”
CZ Kleště kotvící pro Molly hmoždinky
HU Molly fogó üreges bővítőcsavarokhoz
RO Clește dibluri
FR Pince pour chevilles creux
IT Crimpatrice per pioli „Molly”
ES Alicates para tacos „Molly”
CN 膨胀螺栓钳组套

175
mm

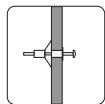

YATO	L [mm]	
YT-51452	175	5/30

EN Pliers for hollow expansion bolts
PL Zaciskarka do kołków „Molly”
DE Maueranker-Einsetzwerkzeug
RU Клещи для дюбелей „Молли”
CZ Kleště kotvící pro Molly hmoždinky
HU Molly fogó üreges bővítőcsavarokhoz
RO Clește dibluri
FR Pince pour chevilles creux
IT Crimpatrice per pioli „Molly”
ES Alicates para tacos „Molly”
CN 膨胀螺栓钳组套

60
PCS



Ø 7 mm (32 mm) x35;
Ø 9 mm (37 mm) x15;
Ø 9 mm (52 mm) x10;
Ø 4 mm (40 mm);
Ø 5 mm (44 mm);
Ø 5 mm (58 mm)

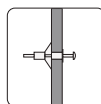

YATO		
YT-51451	3/12	

EN Plastic blind rivets
PL Nity plastikowe
DE Kunststoffnieten
RU Пластиковые заклепки
CZ Plastové nýty
HU Műanyag szegecssek
RO Nituri din plastic
FR Rivets en plastique
IT Rivetti in plastica
ES Remaches de plástico
CN 塑料铆钉

10
PCS

NYLON



YATO	Size / Rozmiar [mm]	
YT-35981	5.0x15.8	250
YT-35982	5.0x17.2	250
YT-35980	6.3x25.2	250
YT-35983	6.6x17.2	250

EN Pliers for hollow expansion bolts
PL Zaciskarka do kołków „Molly”
DE Maueranker-Einsetzwerkzeug
RU Клещи для дюбелей „Молли”
CZ Kleště kotvící pro Molly hmoždinky
HU Molly fogó üreges bővítőcsavarokhoz
RO Clește dibluri
FR Pince pour chevilles creux
IT Crimpatrice per pioli „Molly”
ES Alicates para tacos „Molly”
CN 膨胀螺栓钳组套

10
PCS

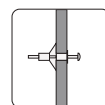

Ø 7 mm (32 mm) x5;
Ø 9 mm (37 mm) x5;
Ø 4 mm (40 mm);
Ø 5 mm (44 mm)

YATO		
YT-51450	6/24	

EN Screw & plug set
PL Zestaw wkrętów i kołków rozporowych
DE Dübel- und Schrauben Sortiment
RU Набор крепежа шурупы и дюбели
CZ Set šroubů a hmoždinek
HU Csavar és tipli készlet
RO Set dibluri + holsuruburi
FR Set vis et chevilles
IT Set di viti e tasselli a espansione
ES Juego de tornillos y tacos
CN 膨胀螺丝组套

266
PCS

PE

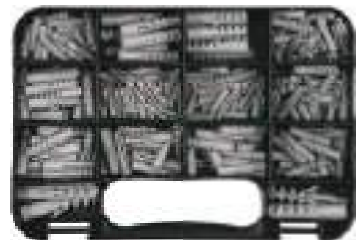

4 x 20 mm (80 PCS), 5 x 25 mm (50 PCS), 6 x 30 mm (60 PCS),
7 x 35 mm (30 PCS), 8 x 40 mm (30 PCS), 10 x 45 mm (12 PCS), 12 x 60 mm (4 PCS)

YATO		
YT-36502	8/16	

EN Hardened knurled nails assortment
PL Radekowane gwoździe do betonu
DE Stahlnägel geriffelt Sortiment
RU Гвозди оцинкованные для бетона
CZ Kalený hřebík do betonu
HU Recézett szeg készlet
RO Set cuie striate
FR Assortiment de clous mousés harnes
IT Chiodi zigrinati per calcestruzzo
ES Jogo de pregos durados com erradas
CN 竹节钉组套

106
PCS

ZINC
PLATED
OCYNKO-
WANA



3.5 x 50 mm (66 PCS), 3.5 x 70 mm (40 PCS)

YATO		
YT-36510	12/24	

EN Staple gun
PL Zszywacz tapicerski
DE Tacker
RU Crennep

CZ Čalounická sešivačka
HU Kárpitos tűzőgép
RO Capsator tapiterie
FR Agrafeuse tapisier

IT Cucitrice per tappezzerie
ES Grapadora de tapicero
CN 打钉枪

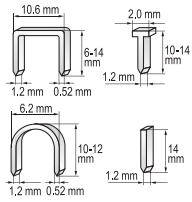

YATO
YT-7000

12/24

EN Staple gun
PL Zszywacz tapicerski
DE Tacker
RU Crennep
CZ Čalounická sešivačka
HU Kárpitos tűzőgép

RO Capsator tapiterie
FR Agrafeuse tapisier
IT Cucitrice per tappezzerie
ES Grapadora de tapicero
CN 打钉枪

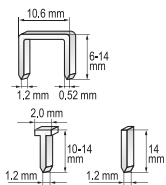
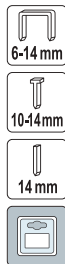

YATO
YT-7003

6/24

EN Staple gun
PL Zszywacz tapicerski
DE Tacker
RU Crennep
CZ Čalounická sešivačka
HU Kárpitos tűzőgép

RO Capsator tapiterie
FR Agrafeuse tapisier
IT Cucitrice per tappezzerie
ES Grapadora de tapicero
CN 打钉枪

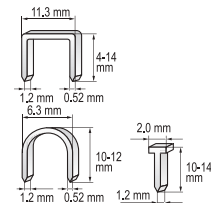
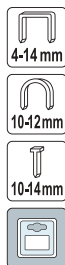

YATO
YT-70020

6/24

EN Staple gun
PL Zszywacz tapicerski
DE Tacker
RU Crennep
CZ Čalounická sešivačka
HU Kárpitos tűzőgép
RO Capsator tapiterie
FR Agrafeuse tapisier
IT Cucitrice per tappezzerie
ES Grapadora de tapicero
CN 打钉枪



EN Staple gun
PL Zszywacz tapicerski
DE Tacker
RU Crennep

CZ Čalounická sešivačka
HU Kárpitos tűzőgép
RO Capsator tapiterie
FR Agrafeuse tapisier

IT Cucitrice per tappezzerie
ES Grapadora de tapicero
CN 打钉枪

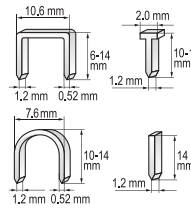

YATO
YT-7001

12/24

EN Staple gun
PL Zszywacz tapicerski
DE Tacker
RU Crennep
CZ Čalounická sešivačka
HU Kárpitos tűzőgép

RO Capsator tapiterie
FR Agrafeuse tapisier
IT Cucitrice per tappezzerie
ES Grapadora de tapicero
CN 打钉枪

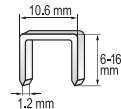
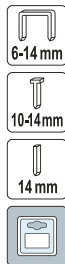

YATO
YT-7005

6/24

EN Staple gun
PL Zszywacz tapicerski
DE Tacker
RU Crennep
CZ Čalounická sešivačka
HU Kárpitos tűzőgép

RO Capsator tapiterie
FR Agrafeuse tapisier
IT Cucitrice per tappezzerie
ES Grapadora de tapicero
CN 打钉枪

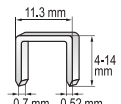
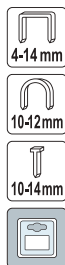

YATO
YT-7007

12/24

EN Staple gun
PL Zszywacz tapicerski
DE Tacker
RU Crennep
CZ Čalounická sešivačka
HU Kárpitos tűzőgép
RO Capsator tapiterie
FR Agrafeuse tapisier
IT Cucitrice per tappezzerie
ES Grapadora de tapicero
CN 打钉枪

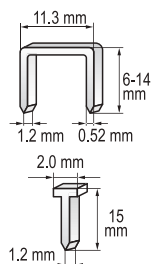

YATO
YT-70021

6/24

- EN Hammer tacker
PL Zszywacz młotkowy
DE Hammer Tacker
RU Молотковый степлер
CZ Sponkovač kládřivový
HU Kalapács tűzőgép
- RO Capsator ciocan
FR Marteau agrafeur
IT Martello cucitrice
ES Grapadora de martillo
CN 钉锤

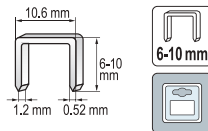

YATO
YT-7004

10/20

- EN Hog ring pliers
PL Szczypce do łączenia siatki
DE Gitterverbindungsange
RU Клещи для обжима сетки
CZ Kleště pro spojování pletiva
HU Drótrögzítő kapcsozó fogó
RO Clește pt. inele
FR Pince à grillage
IT Pinza clippatrice per reti
ES Grapadora para mallas
CN 封口钳



YATO
YT-51470

L [mm]

190

40

- EN Staples
PL Zszywki
DE Heftklammern
RU Скобы
CZ Sponky
HU Tűzőkapocs
RO Capse tapiterie
FR Agrafes
IT Punti
ES Grapas
CN 码钉

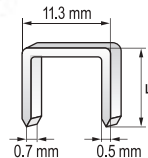
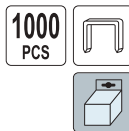

For YT-7007
Dla YT-7007

YATO	L [mm]	pcs / szt.	Box
YT-7051	6	1000	60/360
YT-7052	8	1000	60/300
YT-7053	10	1000	60/240
YT-7054	12	1000	50/200
YT-7055	14	1000	40/160

- EN Hog ring staples C-type
PL Klamry typu "C" do łączenia siatki
DE C-Typ-Schnallen für Netzverbindungen
RU Скобы типа "C" для обжима сетки
CZ Svrky typu "C" pro spojování pletiva
HU "C" típusú drótrögzítő kapocs
RO Capse inele tip "C"
FR Agrafes en "C" pour pince à grillage
IT Punti tipo "C" per pinza clippatrice
ES Grapas tipo "C" para mallas
CN 钉



For YT-51470
Dla YT-51470

YATO
YT-51471

20

- EN Staple remover
PL Rozszywacz
DE Klammern abwender
RU Скобуудалитель
CZ Rozešivač
HU Kapocsiszedő
- RO Extractor capse
FR Degrafeuse
IT Fiocco di rimozione
ES Quitagrapas
CN 起钉器



YATO
YT-7011

25/100

- EN Staples
PL Zszywki
DE Heftklammern
RU Скобы
CZ Sponky
HU Tűzőkapocs
RO Capse tapiterie
FR Agrafes
IT Punti
ES Grapas
CN 码钉

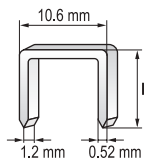
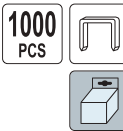

For YT-7000, YT-7001, YT-7003, YT-7005, YT-70020, YT-70021
Dla YT-7000, YT-7001, YT-7003, YT-7005, YT-70020, YT-70021

YATO	L [mm]	pcs / szt.	Box
YT-7022	6	1000	50/200
YT-7023	8	1000	50/200
YT-7024	10	1000	50/100
YT-7025	12	1000	50/100
YT-7026	14	1000	50/100

- EN Staples
PL Zszywki
DE Heftklammern
RU Скобы
CZ Sponky
HU Tűzőkapocs
RO Capse tapiterie
FR Agrafes
IT Punti
ES Grapas
CN 码钉

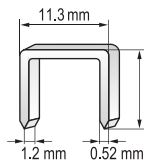
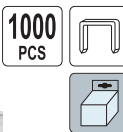

For YT-70020, YT-70021
Dla YT-70020, YT-70021

YATO	L [mm]	pcs / szt.	Box
YT-70270	6	1000	50/200
YT-70271	8	1000	50/200
YT-70272	10	1000	50/100
YT-70273	12	1000	50/100
YT-70274	14	1000	50/100

- EN Nails for staple gun
PL Gwoździe do zszywacza
DE Nageln für Yato Tacker
RU Гвозди для степлера
CZ Hřebíky na sešivačku
HU Szegek a tűzőgéphez
- RO Cuie pt. capsator
FR Clous pour agrafeuses
IT Chiodi per cucitrice
ES Clavos para grapadoras
CN 直钉

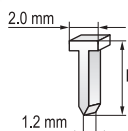

For YT-7000, YT-7001
Dla YT-7000, YT-7001

YATO	L [mm]	pcs / szt.	Box
YT-7032	10	1000	50/200
YT-7033	12	1000	50/200
YT-7034	14	1000	50/200

EN Foam gun
PL Pistolet do pianki montażowej
DE Farbspritzpistole

RU Пистолет для нанесения полиуретановой пены
CZ Pistole na montážní pěnu
HU Felrakó pisztoly, poliurethán habhoz

RO Pistol pt. spumă
FR Pistolet mousse expansive
IT Pistola per schiuma poliuretanică

ES Pistola para espuma de montaje de metal
CN 发泡枪

PTFE



YATO 

YT-6740



10/20

YATO 

YT-6741



10/20



YATO 

YT-6743



20

YATO 

YT-6745



20

EN Foam gun
PL Pistolet do pianki montażowej
DE Farbspritzpistole

RU Пистолет для нанесения полиуретановой пены
CZ Pistole na montážní pěnu
HU Felrakó pisztoly, poliurethán habhoz

RO Pistol pt. spumă
FR Pistolet mousse expansive
IT Pistola per schiuma poliuretanică

ES Pistola para espuma de montaje de metal
CN 发泡枪

AI

QUICK FLOW
ADJUSTMENT
SZYBKĄ
REGULACJĄ
WYPŁYWU



PTFE

PTFE

YATO 

YT-67421



20

YATO 

YT-67441



20

YATO 

YT-67433



20

EN Foam gun
PL Pistolet do pianki montażowej
DE Schaumpistole
RU Пистолет для монтажной пены
CZ Pistole na montážní pěnu
HU Szerelőhab kinyomó pisztoly

RO Pistol pt. spumă
FR Pistolet à mousse expansive
IT Pistola per schiuma poliuretanică
ES Pistola para espuma de poliuretano
CN 发泡枪

320
mm

AI

PTFE



YATO 

YT-67422



20

EN Foam gun
PL Pistolet do pianki montażowej
DE Schaumpistole
RU Пистолет для монтажной пены
CZ Pistole na montážní pěnu
HU Szerelőhab kinyomó pisztoly

RO Pistol pt. spumă
FR Pistolet à mousse expansive
IT Pistola per schiuma poliuretanică
ES Pistola para espuma de poliuretano
CN 发泡枪

500
mm

AI

QUICK FLOW
ADJUSTMENT
SZYBKĄ
REGULACJĄ
WYPŁYWU



YATO 

YT-67460



20

EN Caulking gun
PL Wyciskacz do mas
DE Kartuschenpistole
RU Пистолет для герметика
CZ Ruční výtlačná pistole
HU Extrudáló pisztoly
RO Pistol silicon
FR Pistolet à cartouche
IT Pistola per silicone
ES Pistola para masilla
CN 堵缝枪

225
mm

300
ml



EN Caulking gun
PL Wyciskacz do mas
DE Kartuschenpistole
RU Пистолет для герметика
CZ Ruční výtlačná pistole
HU Extrudáló pisztoly
RO Pistol silicon
FR Pistolet à cartouche
IT Pistola per silicone
ES Pistola para masilla
CN 堵缝枪

225
mm

300
ml



EN Caulking gun
PL Wyciskacz do mas
DE Kartuschenpistole
RU Пистолет для герметика
CZ Ruční výtlačná pistole
HU Extrudáló pisztoly
RO Pistol silicon
FR Pistolet à cartouche
IT Pistola per silicone
ES Pistola para masilla
CN 堵缝枪

225
mm

310
ml



YATO 

YT-6751

L [mm]

225



10/12

YATO 

YT-6753

L [mm]

225



6/12

YATO 

YT-6754

L [mm]

225



6/12

EN Caulking gun
PL Wyciskacz do mas
DE Kartuschenpistole
RU Пистолет для герметика
CZ Ruční výtlačná pistole
HU Extrudáló pisztoly
RO Pistol silicon
FR Pistolet à cartouche
IT Pistola per silicone
ES Pistola para masilla
CN 堵缝枪

225 mm 300 ml



YATO	L [mm]	
YT-6750	225	20/24

EN Caulking gun
PL Wyciskacz do mas
DE Kartuschenpistole
RU Пистолет для герметика
CZ Ruční výtlačná pistole
HU Extrudáló pisztoly
RO Pistol silicon
FR Pistolet à cartouche
IT Pistola per silicone
ES Pistola para masilla
CN 堵缝枪

225 mm 300 ml



YATO	L [mm]	
YT-6755	225	10/20

EN Caulking gun
PL Wyciskacz do mas
DE Kartuschenpistole
RU Пистолет для герметика
CZ Ruční výtlačná pistole
HU Extrudáló pisztoly
RO Pistol silicon
FR Pistolet à cartouche
IT Pistola per silicone
ES Pistola para masilla
CN 堵缝枪

205 mm 300 ml



YATO	L [mm]	
YT-67573	205	10

EN Caulking gun
PL Wyciskacz do mas
DE Kartuschenpistole
RU Пистолет для герметика
CZ Ruční výtlačná pistole
HU Extrudáló pisztoly
RO Pistol silicon
FR Pistolet à cartouche
IT Pistola per silicone
ES Pistola para masilla
CN 堵缝枪

245 mm 400 ml



YATO	L [mm]	
YT-67574	245	12

EN Caulking gun
PL Wyciskacz do mas
DE Kartuschenpistole
RU Пистолет для герметика
CZ Ruční výtlačná pistole
HU Masszakinyomó
RO Pistol silicon
FR Pistolet à feutrer
IT Pistola per silicone
ES Pistola para masilla
CN 堵缝枪



225x60 mm



225x70 mm



225x60 mm

YATO	L [mm]	
YT-67520	225	12

YATO	L [mm]	
YT-67560	225	6

YATO	L [mm]	
YT-67570	225	12

EN Air caulking gun
PL Pneumatyczny wyciskacz do mas
DE Pneumatische Kartuschenpistole
RU Пневматический пистолет для герметика
CZ Pneumatická výtlačná pistole
HU Pneumatikus extrudáló pisztoly
RO Pistol pneumatic pt. silicon
FR Pistolet à extruder pneumatique
IT Pistola pneumatica per sigillanti
ES Pistola pneumatica para masilla
CN 气动胶枪

1.0 MPa 380 mm 600 ml AI STANDARD



$L_{pA} < 70$ dB; $L_{wA} < 80$ dB; $a_n < 2,5$ m/s²

YATO	L [mm]	
YT-67470	380	10

EN Caulking gun
PL Wyciskacz do mas
DE Kartuschenpistole
RU Пистолет для герметика
CZ Ruční výtlačná pistole
HU Extrudáló pisztoly
RO Pistol silicon
FR Pistolet à cartouche
IT Pistola per silicone
ES Pistola para masilla
CN 堵缝枪

600 mm 60 mm 2.0 mm TRANSPARENT PRZEZROCZYSTY



YATO	L [mm]	
YT-67571	600	20

EN Sealed nozzle set
PL Końcówki do nakładania silikonu
DE Enden zum Auftragen von Silikon
RU Наконечники для нанесения силикона
CZ Koncovky pro nanášení silikonu
HU Szilikon felhelyező fejek
RO Set duze
FR Embouts d'application du silicone
IT Punte per applicatori di silicone
ES Puntas para aplicar silicona
CN 不锈钢喷嘴



14 PCS SS304 STAINLESS STEEL STAL NIERDZEWNA

YATO	Ø [mm]	
YT-52622	5, 6, 7, 9, 10, 12, 13, 16, 20, 25, 26, 28, 30, 35	50

EN Pressure roller for use in bonding and laminating
 PL Walek do silnego dociskania klejonych powierzchni
 DE Andruckrolle zum starken Andrücken auf geklebte Oberflächen
 RU Ролик для сильного прижима приклеенных поверхностей
 CZ Váleček pro silné přitlačení lepených povrchů
 HU Henger ragasztott felületek erős lenyomásához
 RO Rola pt. lipit si laminat
 FR Rouleau à lisser
 IT Rullo pressore per superfici difficili da incollare
 ES Rodillo para apretar superficies pegadas
 CN 地毯滚筒

38x75 mm

320 mm

RUBBER GUMA

AI



YATO	Roller size / Rozmiar wałka [mm]	L [mm]	
YT-44150	38x75	320	6/24

EN Pressure roller for use in bonding and laminating
 PL Walek do silnego dociskania klejonych powierzchni
 DE Andruckrolle zum starken Andrücken auf geklebte Oberflächen
 RU Ролик для сильного прижима приклеенных поверхностей
 CZ Váleček pro silné přitlačení lepených povrchů
 HU Henger ragasztott felületek erős lenyomásához
 RO Rola pt. lipit si laminat
 FR Rouleau à lisser
 IT Rullo pressore per superfici difficili da incollare
 ES Rodillo para apretar superficies pegadas
 CN 地毯滚筒

38x75 mm

370 mm

RUBBER GUMA

STEEL STAL



YATO	Roller size / Rozmiar wałka [mm]	L [mm]	
YT-44151	38x75	370	6/24

EN Pressure roller for use in bonding and laminating
 PL Walek do silnego dociskania klejonych powierzchni
 DE Andruckrolle zum starken Andrücken auf geklebte Oberflächen
 RU Ролик для сильного прижима приклеенных поверхностей
 CZ Váleček pro silné přitlačení lepených povrchů
 HU Henger ragasztott felületek erős lenyomásához
 RO Rola pt. lipit si laminat
 FR Rouleau à lisser
 IT Rullo pressore per superfici difficili da incollare
 ES Rodillo para apretar superficies pegadas
 CN 地毯滚筒

38x190 mm

450-690 mm

RUBBER GUMA

STEEL STAL



YATO	Roller size / Rozmiar wałka [mm]	L [mm]	
YT-44152	38x190	450-690	6

EN Stainless steel cable ties
 PL Opaski zaciskowe ze stali nierdzewnej
 DE Edelstahl-Kabelbinder
 RU Хомуты из нержавеющей стали
 CZ Hadicové svorky z nerezové oceli
 HU Rozsdamentes acél kábelkötőgél

RO Legături pt. cabluri oțel
 FR Colliers de serrage en acier inoxydable
 IT Fascette in acciaio inossidabile
 ES Abrazaderas de acero inoxidable
 CN 不锈钢扎带

SS201
 STAINLESS STEEL
 STAL NIERDZEWNA



YATO	Size / Rozmiar [mm]	pcs / szt.	
YT-70560	4.6x125	100	100
YT-70561	4.6x200	100	100
YT-70562	4.6x250	100	50
YT-70563	4.6x300	100	50
YT-70564	4.6x350	100	50
YT-70565	4.6x400	100	50
YT-70566	4.6x450	100	50

YATO	Size / Rozmiar [mm]	pcs / szt.	
YT-70567	4.6x500	100	50
YT-70568	4.6x550	100	50
YT-70569	4.6x600	100	50
YT-70570	4.6x650	100	50
YT-70571	4.6x700	100	50
YT-70580	8.0x200	50	80
YT-70581	8.0x250	50	80

YATO	Size / Rozmiar [mm]	pcs / szt.	
YT-70582	8.0x300	50	60
YT-70583	8.0x350	50	60
YT-70584	8.0x400	50	50
YT-70585	8.0x450	50	50
YT-70586	8.0x500	50	50
YT-70587	8.0x550	50	50
YT-70588	8.0x600	50	50

EN Cable ties
 PL Opaski plastikowe
 DE Kabelbinder
 RU Кабельные стяжки пластиковые
 CZ Stahovací pásky plastové
 HU Kábelkötőgél

RO Set coliere din plastic
 FR Attaches de câble
 IT Fascette di plastica
 ES Bidas de plástico
 CN 尼龙扎带

50 PCS
 PA66
 UL94 V-2
 Juv



YATO	Size / Rozmiar [mm]	Max. tensile strength / Maks. odporność na zrywanie [kg]	Max. wire bundle diameter / Maks. średnica wiązki kabli [mm]	pcs / szt.	
YT-70630	7.6x200	55	50	50	75/150
YT-70631	7.6x300	55	80	50	50/100
YT-70632	7.6x350	55	90	50	50/100
YT-70633	7.6x400	55	105	50	50/100
YT-70634	7.6x430	55	105	50	50/100

YATO	Size / Rozmiar [mm]	Max. tensile strength / Maks. odporność na zrywanie [kg]	Max. wire bundle diameter / Maks. średnica wiązki kabli [mm]	pcs / szt.	
YT-70635	7.6x500	55	145	50	40/80
YT-70636	9.0x450	80	108	50	30/60
YT-70637	9.0x550	80	160	50	25/50
YT-70638	9.0x700	80	195	50	20/40
YT-70639	12.6x760	114	205	50	10/20

EN Cable ties
 PL Opaski plastikowe
 DE Kabelbinder
 RU Кабельные стяжки пластиковые
 CZ Stahovací pásky plastové
 HU Kábelkötőgél

RO Set coliere din plastic
 FR Attaches de câble
 IT Fascette di plastica
 ES Bidas de plástico
 CN 尼龙扎带

50 PCS
 PA66
 UL94 V-2
 Juv



YATO	Size / Rozmiar [mm]	Max. tensile strength / Maks. odporność na zrywanie [kg]	Max. wire bundle diameter / Maks. średnica wiązki kabli [mm]	pcs / szt.	
YT-70650	7.6x200	55	50	50	75/150
YT-70651	7.6x300	55	80	50	50/100
YT-70652	7.6x350	55	90	50	50/100
YT-70653	7.6x400	55	105	50	50/100
YT-70654	7.6x430	55	105	50	50/100

YATO	Size / Rozmiar [mm]	Max. tensile strength / Maks. odporność na zrywanie [kg]	Max. wire bundle diameter / Maks. średnica wiązki kabli [mm]	pcs / szt.	
YT-70655	7.6x500	55	145	50	40/80
YT-70656	9.0x450	80	108	50	30/60
YT-70657	9.0x550	80	160	50	25/50
YT-70658	9.0x700	80	195	50	20/40
YT-70659	12.6x760	114	205	50	10/20

EN Gas torch
PL Palnik gazowy
DE Gasbrenner
RU Газовая горелка
CZ Plynový hořák
HU Gázégő
RO Arzător de gaz
FR Chalumeau à gaz
IT Saldatore bruciatore a gas
ES Soplete de gas
CN 火焰枪



PIEZO 0.7 kW
30 ml 60-90 min
GAS GAZ BUTANE BUTAN
LIGHTER GAS GAZ DO ZAPALNICZEK LOCK BLOKADA
CHILDREN PROTECTION ZABEZPECZENIE PRZED DZIECIAMI



YATO [kW] 10/20
YT-36700 0.7

EN Gas torch
PL Palnik gazowy
DE Gasbrenner
RU Газовая горелка
CZ Plynový hořák
HU Gázégő
RO Arzător de gaz
FR Chalumeau à gaz
IT Saldatore bruciatore a gas
ES Soplete de gas
CN 火焰枪



PIEZO 0.2 kW
13.1 g/h GAS GAZ
BUTANE BUTAN LIGHTER GAS GAZ DO ZAPALNICZEK
LOCK BLOKADA CHILDREN PROTECTION ZABEZPECZENIE PRZED DZIECIAMI

YATO [kW] 50
YT-36725 0.2

EN Gas torch
PL Palnik gazowy
DE Gasbrenner
RU Газовая горелка
CZ Plynový hořák
HU Gázégő
RO Arzător de gaz
FR Chalumeau à gaz
IT Saldatore bruciatore a gas
ES Soplete de gas
CN 火焰枪



PIEZO 0.4 kW
29 g/h 1350 °C
GAS GAZ BUTANE BUTAN
LOCK BLOKADA

YATO [kW] 10/40
YT-36726 0.4

EN Gas torch
PL Palnik gazowy
DE Gasbrenner
RU Газовая горелка
CZ Plynový hořák
HU Gázégő
RO Arzător de gaz
FR Chalumeau à gaz
IT Saldatore bruciatore a gas
ES Soplete de gas
CN 火焰枪



PIEZO 0.13 kW
9.5 g/h 1350 °C
GAS GAZ BUTANE BUTAN
LOCK BLOKADA

YATO [kW] 10/50
YT-36727 0.13

EN Gas blow torch
PL Palnik gazowy
DE Lötbrenner
RU Газовая горелка
CZ Plynový hořák
HU Gázégő
RO Arzator pe gaz
FR Chalumeau à gaz
IT Saldatore bruciatore a gas
ES Soplete de gas
CN 喷枪



PIEZO 1.7 kW
123 g/h GAS GAZ
BUTANE BUTAN



YATO [kW] 40
YT-36711 1.7

EN Gas soldering lamp
PL Gazowa lampa lutownicza
DE Gaslötlampe
RU Газовая паяльная лампа
CZ Plynová pájecí lampa
HU Gázos forrasztólámpa
RO Lampă de lipit pe gaz
FR Lampe à souder
IT Lampada per saldare a gas
ES Lampa de gas para soldar
CN 喷灯



PIEZO 1.7 kW
123 g/h GAS GAZ
BUTANE BUTAN

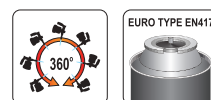

YATO [kW] 12
YT-36720 1.7

EN Soldering tool set
PL Lutownica gazowa z akcesoriami
DE Gaslötkolben Satz
RU Газовый паяльный набор
CZ Plynova pajka souprava
HU Gaz forrasztópaka készletek
RO Set ciocan de lipit cu gaz
FR Fer à souder à gaz
IT Saldatore a gas
ES Soldador a gas con accesorios
CN 自动点火多功能瓦斯组套

7 PCS PIEZO 30-125 W 30 ml 75 min GAS GAZ BUTANE BUTAN PROPANE BUTANE PROPAN BUTAN LIGHTER GAS GAZ DO ZAPALNICZEK LOCK BLOKADA CHILDREN PROTECTION ZABEZPECZENIE PRZED DZIECIAMI

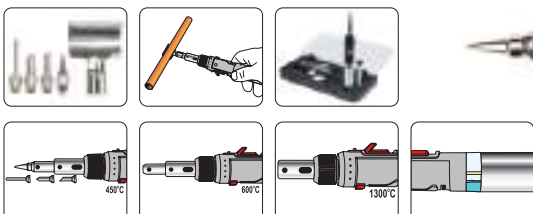

YATO [W] 6
YT-36706 30-125

EN Gas blow torch
 PL Palnik gazowy
 DE Lötbrenner
 RU Газовая горелка
 CZ Plynový hořák
 HU Gázégő
 RO Arzător de gaz
 FR Chalumeau à gaz
 IT Saldatore bruciatore a gas
 ES Soplete de gas
 CN 火焰枪

PIEZO 1.0 kW 73 g/h GAS GAZ BUTANE BUTAN



YATO	[kW]	
YT-36710	1	10/100

EN Gas blow torch
 PL Palnik gazowy
 DE Lötbrenner
 RU Газовая горелка
 CZ Plynový hořák
 HU Gázégő
 RO Arzător de gaz
 FR Chalumeau à gaz
 IT Saldatore bruciatore a gas
 ES Soplete de gas
 CN 火焰枪

PIEZO 1.28 kW GAS GAZ AIR POWIETRZE LOCK BLOKADA BUTANE BUTAN



YATO	[kW]	
YT-36709	1.28	6/12

EN Turbo gas torch
 PL Palnik gazowy turbo
 DE Turbo-Handbrenner
 RU Газовая горелка турбо
 CZ Plynový hořák turbo
 HU Kézi gázégő
 RO Arzător cu gaz turbo
 FR Chalumeau à gaz
 IT Saldatore bruciatore a gas
 ES Quemador de gas turbo
 CN 手持式焊枪

PIEZO 2800 °C 2.0 kW 142 g/h 2.59 MPa G1" F GAS GAZ PROPANE PROPAN AUTO START STOP LOCK BLOKADA CONTINUOUS RUN LOCK BLOKADA PRACY CIĄGŁE TURBO NOZZLE DYŻKA TURBO

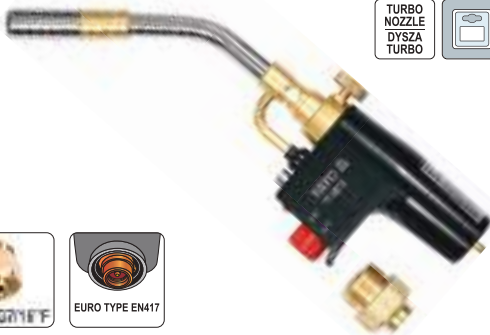

YATO	[kW]	
YT-36715	2	5/20

EN Gas blow torch
 PL Palnik gazowy
 DE Lötbrenner
 RU Газовая горелка
 CZ Plynový hořák
 HU Gázégő
 RO Arzător de gaz
 FR Chalumeau à gaz
 IT Saldatore bruciatore a gas
 ES Soplete de gas
 CN 喷枪

PIEZO 2.0 kW 145 g/h GAS GAZ BUTANE BUTAN

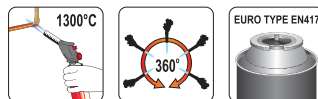

YATO	[kW]	
YT-36712	2	20/80

EN Blow torch
 PL Lutownica gazowa dekarska
 DE Gas-Dachdeckerlötkolben
 RU Кровельный газовый паяльник
 CZ Pokryvačská plynová pájka
 HU Gázégő tetőfedő munkákhoz
 RO Arzator gaz
 FR Fer à souder couvreur
 IT Cannello saldatore a gas per posa coperture tetti
 ES Soldador a gas de tejias
 CN 焊枪套装



PROPANE BUTANE PROPAN BUTAN Cu TIP GROȚ 1.5 m

YATO	[W]	L [mm]	
YT-36701	4	360	20

EN Soldering torch
 PL Palnik do lutowania
 DE Lötbrenner
 RU Горелка для пайки
 CZ Pájecí hořák
 HU Forrasztópáka
 RO Lampa pt. sudura
 FR Torche de soudage
 IT Cannello di brasatura
 ES Soplete de soldadura
 CN 焊枪套装

4 kW 290 g/h 360 mm PROPANE BUTANE PROPAN BUTAN x3 20/40/50 mm 1.5 m



YATO	[kW]	L [mm]	
YT-36730	4	360	20

EN Soldering torch
 PL Palnik do lutowania
 DE Lötbrenner
 RU Горелка для пайки
 CZ Pájecí hořák
 HU Forrasztópáka

4 kW 288 g/h 360 mm PROPANE BUTANE PROPAN BUTAN x3 13/14/17 mm



YATO	[kW]	L [mm]	
YT-36731	4	360	20

EN Roofing torch
PL Palnik dekarSKI
DE Dachdeckerbrenner
RU Горелка кровельная
CZ Pokrývačský hořák
HU Tetőfedő égő
RO Lampa pt. izolații
FR Outil à souder pour toiture
IT Cannello per posa coperture tetti
ES Antorcha de techo
CN 焊枪套装



YATO	[kW]	L [mm]	
YT-36740	8	370	10

EN Roofing torch
PL Palnik dekarSKI
DE Dachdeckerbrenner
RU Горелка кровельная
CZ Pokrývačský hořák
HU Tetőfedő égő
RO Lampa pt. izolații
FR Outil à souder pour toiture
IT Cannello per posa coperture tetti
ES Antorcha de techo
CN 焊枪套装

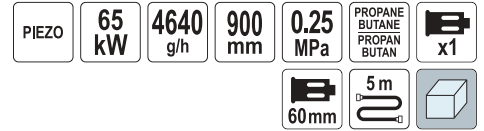

YATO	[kW]	L [mm]	
YT-36741	65	900	6

EN Weed burner
PL Palnik do wypalania chwastów
DE Unkrautbrenner
RU Горелка для выжигания сорняков
CZ Hořák na plevel
HU Gyomégető

RO Arzator pt. buruieni
FR Désherbeur thermique
IT Bruciatore di erbacce
ES Quemador de malezas
CN 除草炬



EURO TYPE EN417

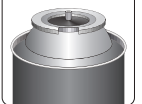

YATO	[kW]	L [mm]	
YT-36742	1.7	800	12

EN Silicone soldering mat
PL Mata silikonowa do lutowania
DE Silikon-Lötmatte
RU Силиконовый коврик для пайки
CZ Silikonová podložka pro letování
HU Szilikon forrasztóalátét
RO Saltea din silicon pt. lipit
FR Tapis à souder en silicone
IT Tappetino per saldatura in silicone
ES Estera de soldadura de silicona
CN 硅胶垫

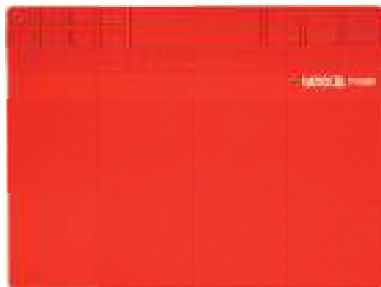

YATO	Size / Rozmiar [mm]	
YT-82468	250x350	50
YT-82469	300x400	30

EN Solvent dispenser with pump
PL Butelka z dozownikiem z pompką
DE Flasche mit Dosiereinrichtung mit Pumpe
RU Бутылка с дозатором-насосом
CZ Láhev s dávkovačem a pumpičkou
HU Úveg pumpás adagolóval
RO Distribuitor de solventi cu pompă
FR Bouteille avec pompe
IT Flacone dosatore a pompa
ES Botella con dispensador y bomba
CN 按压式酒精瓶



YATO	[ml]	
YT-82516	100	20/120

EN Dust blower ball
PL Gruszka do przedmuchiwania
DE Blasebalg
RU Груша для продувки
CZ Hruška pro profukování
HU Porfúvó
RO Pompa suflat praful
FR Poire de gonflage
IT Bulbo soffiatore
ES Pera sopladora
CN 吹尘球



YATO		
YT-82512		30/180

EN Solder iron tips set
PL Zestaw grotów do lutowania
DE Lötspitzenset
RU Набор паяльных жал
CZ Sada páječích hrotů
HU Forrasztóhegy készlet
RO Varfuri pistol de lipit
FR Jeu de pointes de fer à souder
IT Set di punte del saldatore
ES Juego de puntas para soldar
CN 烙铁头6件套



Tip types: T-1, T-B, T-K, T2.4D, T-2C, T-3C
Rodzaje grotów: T-1, T-B, T-K, T2.4D, T-2C, T-3C

YATO		
YT-82525		24/240

EN Solder iron tips set
 PL Zestaw grzyw do lutowania
 DE Lötspitzenset
 RU Набор паяльных жал
 CZ Sada páječích hrotů
 HU Forrasztóhegy készlet
 RO Varfuri pistol de lipit
 FR Jeu de pointes de fer à souder
 IT Set di punte del saldatore
 ES Juego de puntas para soldar
 CN 烙铁头10件套

10 PCS 900M



Tip types: T-1, T-B, T-K, T-1.2D, T2.4D, T-3.2D, T-1C, T-2C, T-3C
 Rodzaje grzyw: T-1, T-B, T-K, T-1.2D, T2.4D, T-3.2D, T-1C, T-2C, T-3C

YATO YT-82526 24/240

EN Sponge for soldering station
 PL Gąbka do stacji lutowniczej
 DE Schwamm für Lötstation
 RU Губка для паяльной станции
 CZ Houbička do páječí stanice
 HU Szivacs forrasztóállomáshoz
 RO Burete pt. statia de lipit
 FR Éponge pour station de soudage
 IT Spugna per stazione di saldatura
 ES Esponja para la estación de soldadura
 CN 烙铁头清洁海绵

3 PCS



YATO YT-82467 40/800

EN Solder tip cleaner brass wire
 PL Czyścik do grzyw z mosiężnymi wiórami
 DE Lötspitzen-Reiniger - Messingspäne
 RU Очиститель паяльных жал, латунная стружка
 CZ Čistič hrotů mosazné hobliny
 HU Pákahegy tisztító rézforgács
 RO Burete sama pt. curatat pistol de lipit
 FR Boule de nettoyage à copeaux de laiton
 IT Pulitore per punte, trucioli in ottone
 ES Alambre de latón para limpieza de puntas de soldadura
 CN 烙铁头除锡球+锡渣盒

BRASS MOSIADZ



YATO YT-82510 30/120

EN Hot air nozzles
 PL Zestaw dysz do gorącego powietrza
 DE Heißluftdüsen
 RU Комплект форсунок для горячего воздуха
 CZ Sada horkovzdušných trysek
 HU Forró levegő fúvókakészlet
 RO Duze aer cald
 FR Jeu de buses à air chaud
 IT Set di ugelli per aria calda
 ES Juego de boquillas para aire caliente
 CN 风咀4件套

4 PCS 12 mm 4.4 mm 8.0 mm 10 mm



YATO YT-82520 50/300

EN Vacuum pen
 PL Chwytnak próżniowy
 DE Vakuumgreifer
 RU Вакуумный захват
 CZ Vakuové chápadlo
 HU Vákuumos alkatrészfogó
 RO Aspirator tip pix
 FR Pince à vide
 IT Utensile da presa a vuoto
 ES Pluma de succión de bomba de vacío
 CN 防静电真空吸笔

3.0 mm 6.0 mm 10 mm 150 mm



YATO YT-82514 12/240

EN Heat resistant tape
 PL Taśma kaptonowa
 DE Kapton-Band
 RU Каптоновая лента
 CZ Kaptonová páska
 HU Kapton szalag
 RO Banda termorezistentă
 FR Bande kapton
 IT Nastro kapton
 ES Cinta kapton
 CN 防焊高温胶带

300 °C



YATO	W [mm]	L [m]	
YT-82540	5	33	110/440
YT-82541	10	33	64/256
YT-82542	20	33	32/128

EN Soldering iron with temperature adjustment
 PL Lutownica z regulacją temperatury
 DE Temperaturgesteuerter LötKolben
 RU Паяльник с терморегулятором
 CZ Pájka s regulací teploty
 HU Hőszabályozós forrasztó

RO Letcon cu reglaj de temperatura
 FR Fer à souder à température réglable
 IT Saldatore con temperatura regolabile
 ES Soldador con ajuste de temperatura
 CN 调温电烙铁

220-240V-50Hz 50 W 200-450 °C +/- 25 °C 900M



- Constant tip temperature control
- Stały odczyt temperatury grzy

YATO YT-82700 50 [W] 200-450 [°C] 10/100

EN Soldering iron with temperature adjustment
 PL Lutownica z regulacją temperatury
 DE Temperaturgesteuerter LötKolben
 RU Паяльник с терморегулятором
 CZ Pájka s regulací teploty
 HU Hőszabályozós forrasztó

RO Letcon cu reglaj de temperatura
 FR Fer à souder à température réglable
 IT Saldatore con temperatura regolabile
 ES Soldador con ajuste de temperatura
 CN 数显电烙铁

220-240V-50Hz 80 W 50-480 °C +/- 2 °C 900M LCD BACKLIGHT POWERSWITCH



- Constant tip temperature control
- Temperature calibration function
- Stały odczyt temperatury grzy
- Funkcja kalibracji temperatury

YATO YT-82701 80 [W] 50-480 [°C] 10/50

- EN Soldering iron
PL Lutownica oporowa
DE Lötkolben
RU Электропаяльник
CZ Pájka odporová
HU Forrasztópáka
- RO Ciocan de lipit
FR Fer à souder
IT Saldatore a stagno
ES Soldador de resistencia
CN 电烙铁



YATO	[W]	[°C]	[mm]	
YT-8271	30	400	Ø3.8x73	16
YT-8272	60	500	Ø5.8x85	16
YT-8273	80	520	Ø6.8x95	16

- EN Desoldering pump
PL Odsysacz do cyny
DE Entlötsaugpumpe
RU Шприц для удаления припоя
- CZ Odrápěcí sací pumpa
HU Ónszippantó
RO Pompa fluidor
FR Pompe à étain
- IT Pompa aspira stagno
ES Bomba desoldadora
CN 全铝手动吸锡器



YATO	
YT-82742	100/400



YATO	
YT-82743	100/200



YATO	
YT-82744	50/100

- EN Solder wick
PL Taśma rozlutownicza, plecionka miedziana
DE Lötdocht - Kupfergeflecht
RU Лента для удаления припоя, медная оплетка
CZ Odrápěcí páska, měděný svazek
HU Fonott réz kiforrasztó huzal
RO Sarma pt. lipit
FR Bande de soudure en cuivre toronné
IT Nastro dissaldante, treccia rame
ES Cinta desoldadora trenza de cobre
CN 吸锡带



YATO	W [mm]	L [m]	
YT-82530	1.5	1.5	30/600
YT-82531	2.0	1.5	30/600
YT-82532	3.0	1.5	30/600

- EN Magnifying glass with LED light
PL Lupa z podświetleniem LED
DE Lupe mit LED-Licht
RU Лупа с LED подсветкой
CZ Lupa s LED osvětlením
HU Nagyító LED világítással
RO Lupa cu LED
FR Loupe avec éclairage LED
IT Lente d'ingrandimento con luce LED
ES Lupa con iluminación LED
CN 放大镜

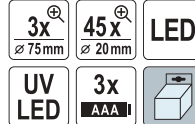

Battery not included
Baterii nie dołączono

YATO	
YT-73845	10/120

- EN Magnifier
PL Szko powiększające
DE Vergrößerungsglas
RU Увеличительное стекло
CZ Lupa
HU Nagyító üveg
RO Lupa
FR Loupe
IT Lente d'ingrandimento
ES Lupa de mano
CN 放大镜



YATO	
YT-73855	10/120

- EN Helping hand with magnifying glass
PL Zestaw „trzecia ręka” z lupą
DE Dritte Hand mit Lupe
RU Комплект „третья ручка” с лупой
CZ Držák třetí ruka s lupou
HU Paneltartó állvány „harmadik kéz”
RO Suport cu lupa pt. ciocan lipit
FR Troisième main avec loupe
IT Supporto terza mano con lente d'ingrandimento
ES Tercera mano con lupa
CN 放大镜



Battery not included
Baterii nie dołączono

YATO	
YT-73861	20

EN Transformer soldering gun
 PL Lutownica transformatorowa
 DE Lötpistole
 RU Электрический паяльник
 CZ Transformátorová páječka
 HU Forrasztópáka

RO Pistol de lipit
 FR Pistolet fer à souder électrique
 IT Saldatore istantaneo
 ES Soldador transformador
 CN 电烙铁

220-240V~50Hz **180 W** 0-600 °C **S2 20%**
WORKING MODE TRYB PRACY
LED
LIGHTING OŚWIETLENIE



YATO	[W]	[°C]	
YT-8245	180	0-600	10

EN Soldering station
 PL Stacja lutownicza
 DE Lötstation
 RU Паяльная станция
 CZ Letovací stanice
 HU Forrasztópáka állomás
 RO Stație de lipit
 FR Station de soudage
 IT Stazione digitale di saldatura
 ES Estación de soldadura
 CN 焊台



220-240V~50Hz **75 W** 200-480 °C +/- 1 °C **900M**
BACKLIGHT PODŚWIETLENIE
LCD **ESD SAFE** **USB**
BATTERY CHARGER ŁADOWNIK

- Constant tip temperature control
- Temperature calibration function
- Auto sleep 1-240 min
- Stały odczyt temperatury grzałki
- Funkcja kalibracji temperatury
- Automatyczny tryb czuwania 1-240 min



YATO	[W]	[°C]	
YT-82456	75	200-480	8

EN Soldering station
 PL Stacja lutownicza
 DE Lötstation
 RU Паяльная станция
 CZ Letovací stanice
 HU Forrasztópáka állomás
 RO Stație de lipit
 FR Station de soudage
 IT Stazione digitale di saldatura
 ES Estación de soldadura
 CN 焊台

220-240V~50Hz **70 W** 200-480 °C +/- 1 °C **900M**
LED **ESD SAFE**

- Constant tip temperature control
- Auto sleep 1-99 min
- Auto power off function 1-99 min
- Stały odczyt temperatury grzałki
- Automatyczny tryb czuwania 1-99 min
- Automatyczne wyłączenie urządzenia 1-99 min



YATO	[W]	[°C]	
YT-82459	70	200-480	8

EN Transformer soldering gun
 PL Lutownica transformatorowa
 DE Lötpistole
 RU Электрический паяльник
 CZ Transformátorová páječka
 HU Forrasztópáka

RO Pistol de lipit
 FR Pistolet fer à souder électrique
 IT Saldatore istantaneo
 ES Soldador transformador
 CN 电烙铁

230-240V~50Hz **200 W** **S2 20%**
WORKING MODE TRYB PRACY
LED
LIGHTING OŚWIETLENIE



YATO	[W]	[°C]	
YT-82451	200	70~200, 201~350, 351~500	10

EN Hot air soldering station
 PL Stacja lutownicza hot air
 DE Heißluft-Lötstation
 RU Термовоздушная паяльная станция
 CZ Horkovzdušná pájecí stanice
 HU Hot air forrasztóállomás
 RO Stație de lipit cu aer cald
 FR Station de soudage à air chaud
 IT Stazione di saldatura Hot Air
 ES Estación de soldadura hot air
 CN 热风拆焊台



220-240V~50Hz **750 W** 100-500 °C +/- 2 °C **120 l/min**
LED **ESD SAFE**

- Brushless motor fan
- Auto sleep 0-240 min
- Auto power off function
- Build-in position sensor
- Bezszczotkowy wentylator
- Automatyczny tryb czuwania
- Automatische Abschaltung des Gerätes
- Czujnik odłożenia grzałki



YATO	[W]	[°C]	
YT-82457	750	100-500	8

EN 2 in 1 hot air soldering station
 PL 2 w 1 stacja lutownicza hot air
 DE 2 in 1 Heißluft-Lötstation
 RU Термовоздушная паяльная станция 2 в 1
 CZ Horkovzdušná pájecí stanice 2 v 1
 HU 2 az 1-ben hot air forrasztóállomás
 RO Stație de lipit, 2 in 1, cu aer cald
 FR Station de soudage à air chaud 2 en 1
 IT 2 in 1 stazione di saldatura hot air
 ES 2 en 1 estación de soldadura hot air
 CN 热风拆焊台

220-240V~50Hz **750 W** 100-480 °C +/- 2 °C **120 l/min**
75 W 200-480 °C +/- 1 °C **900M** **LED**
DISPLAY WYŚWIETLACZ

- Constant tip temperature control
- Brushless motor fan
- Auto sleep 0-240 min
- Auto power off function
- Build-in position sensor

- Stały odczyt temperatury grzałki
- Bezszczotkowy wentylator
- Automatyczny tryb czuwania
- Automatische Abschaltung des Gerätes
- Czujnik odłożenia grzałki



YATO	[W]	[°C]	
YT-82458	75 (lutownica), 750 (dmuchawa hot air)	200-480 (lutownica), 100-480 (dmuchawa hot air)	6

EN Soldering station
PL Stacja lutownicza
DE Lötstation
RU Паяльная станция
CZ Letovací stanice
HU Forrasztópáka állomás
RO Stație de lipit
FR Station de soudage
IT Stazione digitale di saldatura
ES Estación de soldadura
CN 焊台

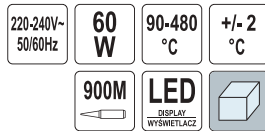

- Constant tip temperature control
- Auto sleep 10 min
- Stały odczyt temperatury grotła
- Automatyczny tryb czuwania 10 min

YATO	[W]	[°C]	
YT-82460	60	90-480	16

EN Soldering station
PL Stacja lutownicza
DE Lötstation
RU Паяльная станция
CZ Letovací stanice
HU Forrasztópáka állomás
RO Stație de lipit
FR Station de soudage
IT Stazione digitale di saldatura
ES Estación de soldadura
CN 焊台



- Constant tip temperature control
- Temperature calibration function
- Stały odczyt temperatury grotła
- Funkcja kalibracji temperatury

YATO	[W]	[°C]	
YT-82461	75	90-480	30

EN Glue sticks
PL Wkłady klejowe
DE Heissklebepatronen
RU Стержин для горячей склейки
CZ Lepicí vložky
HU Ragasztóbetét
RO Mine cu clei
FR Des bâtons de colle
IT Stick di colla
ES Cartucho de cola
CN 透明热熔胶棒



YATO	Ø [mm]	L [mm]	
YT-82430	11	200	20

YATO	Ø [mm]	L [mm]	
YT-82431	11	300	20

EN Glue sticks
PL Wkłady klejowe
DE Heissklebepatronen
RU Стержин для горячей склейки
CZ Lepicí vložky
HU Ragasztóbetét
RO Mine cu clei
FR Des bâtons de colle
IT Stick di colla
ES Cartucho de cola
CN 褐色热熔胶棒



YATO	Color / Kolor	Ø [mm]	L [mm]	
YT-82433	czarny	11	200	40/120
YT-82434	czerwony	11	200	40/120
YT-82435	niebieski	11	200	40/120
YT-82436	zielony	11	200	40/120

YATO	Color / Kolor	Ø [mm]	L [mm]	
YT-82437	żółty	11	200	40/120
YT-82438	biały	11	200	40/120
YT-82439	brązowy	11	200	40/120

- EN Glue sticks
- PL Wkłady klejowe
- DE Heissklebpatronen
- RU Стержин для горячей склейки
- CZ Lepicí vložky
- HU Ragasztóbetét
- RO Mine cu clei
- FR Des bâtons de colle
- IT Stick di colla
- ES Cartucho de cola
- CN 胶棒



10 PCS	7.2mm 200mm	170-200 °C	82±2°C SOFTENING MEKNEGE	20-30 s	TRANSPARENT PRZEZROCZYSTY
------------------	-----------------------	----------------------	---------------------------------------	---------	------------------------------

YATO	Color / Kolor	Ø [mm]	L [mm]	
YT-82440	bezbarny	7.2	200	30/120

- EN Glue sticks
- PL Wkłady klejowe
- DE Heissklebpatronen
- RU Стержин для горячей склейки
- CZ Lepicí vložky
- HU Ragasztóbetét
- RO Mine cu clei
- FR Des bâtons de colle
- IT Stick di colla
- ES Cartucho de cola
- CN 胶棒



12 PCS	7.2mm 100mm	170-200 °C	85±2°C SOFTENING MEKNEGE	20-30 s	
------------------	-----------------------	----------------------	---------------------------------------	---------	--



YATO	Color / Kolor	Ø [mm]	L [mm]	
YT-82441	czarny	7.2	100	50/200
YT-82442	czerwony	7.2	100	50/200
YT-82443	niebieski	7.2	100	50/200
YT-82444	zielony	7.2	100	50/200

YATO	Color / Kolor	Ø [mm]	L [mm]	
YT-82445	żółty	7.2	100	50/200
YT-82446	biały	7.2	100	50/200
YT-82447	brazowy	7.2	100	50/200

- EN Plastic welding rods
- PL Wkłady do spawania plastiku
- DE Kunststoffschweißdrähte
- RU Прутки для сварки пластика
- CZ Tyčinky pro svařování plastů
- HU Műanyag hegesztő pálcá
- RO Batoane plastic pt. lipit
- FR Tiges de soudure plastique
- IT Bacchette per saldatura del materiale plastico
- ES Cartuchos para soldar plástico
- CN 塑料焊条

5 PCS	2.5x5 mm 1m	
-----------------	--------------------------	--



300 °C	PP
------------------	-----------

YATO	Size / Rozmiar [mm]	L [m]	
YT-82303	2.5x5	1	30/120



270-300 °C	PE
----------------------	-----------

YATO	Size / Rozmiar [mm]	L [m]	
YT-82304	2.5x5	1	30/120



350 °C	ABS
------------------	------------

YATO	Size / Rozmiar [mm]	L [m]	
YT-82305	2.5x5	1	30/120



300-400 °C	PVC
----------------------	------------

YATO	Size / Rozmiar [mm]	L [m]	
YT-82306	2.5x5	1	30/120



300 °C	PPR
------------------	------------

YATO	Size / Rozmiar [mm]	L [m]	
YT-82307	2.5x5	1	30/120

- EN Kitchen worktop jig
PL Szablon do łączenia blatów
DE Frässhablone Arbeitsplatte
RU Шаблон для кухонных столешниц
CZ Šablona pro spoj kuchyňských desek
HU Munkalap összemaró sablon
RO Șablon
FR Gabarit de profilage pour plans de travail
IT Sistema di giunzioni per piani da cucina
ES Plantilla para el fresado de encimeras
CN 木工模板



YATO	Dimensions / Wymiary [mm]	
YT-70890	1000x390x12	5

- EN Dovetail marker
PL Szablon do trasowania "jaskółczy ogon"
DE Schwalbenschwanz-Schablone
RU Шаблон ласточкин хвост
CZ Rybinová šablona
HU Fecskefarag fogazó sablon
RO Sablon coada de randunica
FR Gabarit à queue d'aronde
IT Marcatore a coda di rondine
ES Plantilla cola de milano
CN 木工定位器

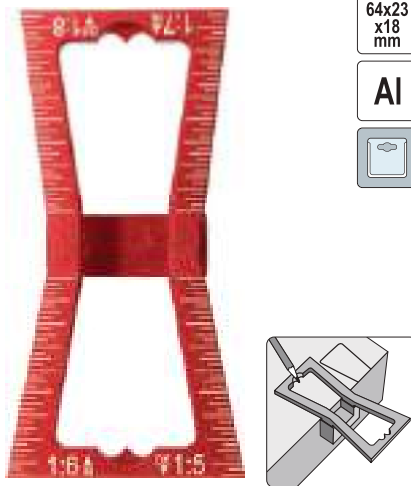

YATO	Dimensions / Wymiary [mm]	
YT-44080	64x23x18	50/200

- EN Dovetail marker
PL Szablon do trasowania "jaskółczy ogon"
DE Schwalbenschwanz-Schablone
RU Шаблон ласточкин хвост
CZ Rybinová šablona
HU Fecskefarag fogazó sablon
RO Sablon coada de randunica
FR Gabarit à queue d'aronde
IT Marcatore a coda di rondine
ES Plantilla cola de milano
CN 木工定位器

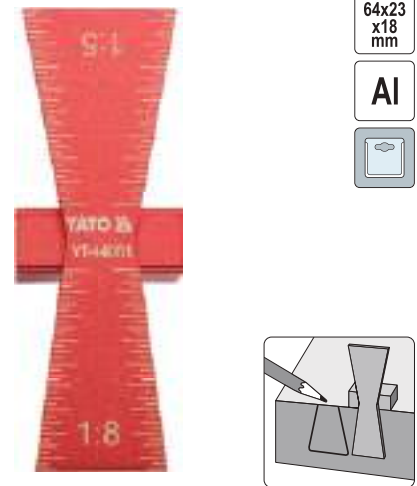

YATO	Dimensions / Wymiary [mm]	
YT-44081	64x23x18	50/200

- EN Tine milling template
PL Szablon frezarski do połączeń na jaskółczy ogon
DE Zinkenfrässhablone
RU Шипорезное приспособление для соединения "ласточкин хвост"
CZ Cinkovací přípravek
HU Csapoló készülék
RO Sablon pt. imbinării coada de randunica
FR Gabarit pour assemblages à queues d'aronde
IT Dima per fresatura per collegamenti a coda di rondine
ES Plantilla para juntas cola milano
CN 开榫机

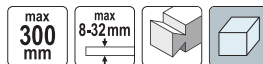

YATO	Dimensions / Wymiary [mm]	
YT-44085		2

- EN Aluminium alloy scribe gauge
PL Przymiar traserski stolarski
DE Anreißschablone für Schreiner
RU Линейка для разметки и столярных работ
CZ Rýsovací a tesafské pravítko
HU Asztalos sablon
RO Sablon din aluminiu
FR Gabarit de pose charpentier
IT Righello per falegnameria
ES Regla de carpintería
CN 木工划线器

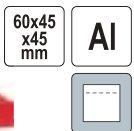
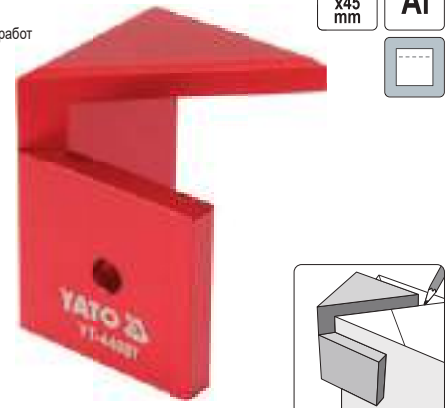

YATO	Dimensions / Wymiary [mm]	
YT-44087	60x45x45	50/200

- EN Hinge hole drilling guide locator
PL Szablon do osadzania zawiasów
DE Scharnier-Montageschablone
RU Шаблон для установки петель
CZ Šablona pro montáž závěsů
HU Zsanér sablon
RO Dispozitiv ghidaj gaurile balamale
FR Gabarit de perçage pour charnières
IT Dima di traccia per cerniere
ES Plantilla para bisagras
CN 定位器



YATO	Dimensions / Wymiary [mm]	
YT-44135	85x40x22	50/200

- EN Hinge hole drilling guide locator
PL Szablon do osadzania zawiasów
DE Scharnier-Montageschablone
RU Шаблон для установки петель
CZ Šablona pro montáž závěsů
HU Zsanér sablon
RO Dispozitiv ghidaj gaurile balamale
FR Gabarit de perçage pour charnières
IT Dima di traccia per cerniere
ES Plantilla para bisagras
CN 定位器



YATO	Dimensions / Wymiary [mm]	
YT-44136	270x55x3.6	50/200

13

Construction tools
Narzędzia budowlane



Floor laminate cutters & accessories
Gilotyny do cięcia paneli podłogowych i akcesoria
276 

Scaffolds
Rusztowania
292 

Floor plank cutters
Gilotyny do cięcia wykładzin
276 

Straight pliers
Kleszcze do cięcia blach
292-293 

Tile cutting machines & accessories
Przyrządy do cięcia glazury i akcesoria
277-279 

Roofwork tools
Narzędzia dekarские
293 

Jigs & patterns
Wzorniki i szablony
279-280 

Paving tools
Narzędzia brukarskie
293-294 

Scrapers & accessories
Szpachelki i akcesoria
280-282 

Floating rules
Łaty
294 

Masonry tools
Narzędzia tynkarskie i murarskie
282-287 

Knives
Noże
294 

Floats
Pace..... 282
Trowels
Kielnie..... 285
Plaster scrubbers
Zdzieraki do tynków..... 286
Mortar guns
Wyciskacze do zapraw..... 286
Plaster & stucco spray guns
Tynkownice pneumatyczne..... 286
Finishing work tools
Narzędzia do prac wykończeniowych..... 286

Electric hoists
Elektryczne wciągarki linowe
295 

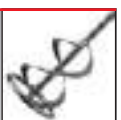
Mixers
Mieszadła
295-296 

Painting tools
Narzędzia malarskie
288-289 

Suction lifters
Uchwyty do szyb
296-297 

Paint brushes
Pędzle..... 288
Painting bowls
Kuwety malarskie..... 289
Painting mixers
Mieszadła do farb..... 289
Painting buckets
Wiadra malarskie..... 289
Painting sheets
Folie malarskie..... 289

Pencils & chalks
Ołówki i kredy
297-298 

Pencils
Ołówki..... 297
Chalks
Kredy..... 298

Tools for drywalls
Narzędzia do płyt gipsowo-kartonowych
289-292 

EN Floor laminate cutter
 PL Gilotylna do cięcia paneli podłogowych
 DE Laminat-Schneider
 RU Гильотина для ламината
 CZ Nůžky na laminátové plovoucí podlahy
 HU Laminált padló vágógép
 RO Aparat de tăiat parchet laminat
 FR Guillotine pour couper les panneaux
 IT Ghigliottina per taglio dei pannelli
 ES Guillotina cortapaneles
 CN 密度板切割器

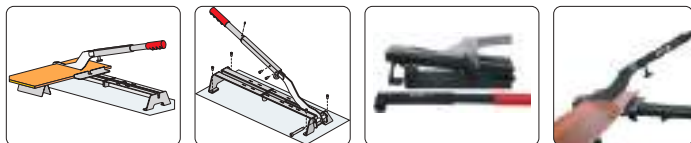

YATO **YT-37301** 2

EN Hardwood floor positioning tool
 PL Dociągacz desek podłogowych
 DE Parkett-Verlegewerkzeug
 RU Струбцина для укладки ламината и паркета
 CZ Nářadí pro montáž podlah
 HU Laminált padló behúzóvas racsnis
 RO Dispozitiv fixare parchet
 FR Outil de redressage de plancher
 IT Attrezzo per installazione di pavimenti
 ES Conector de posicionamiento de pisos
 CN 地板安装器

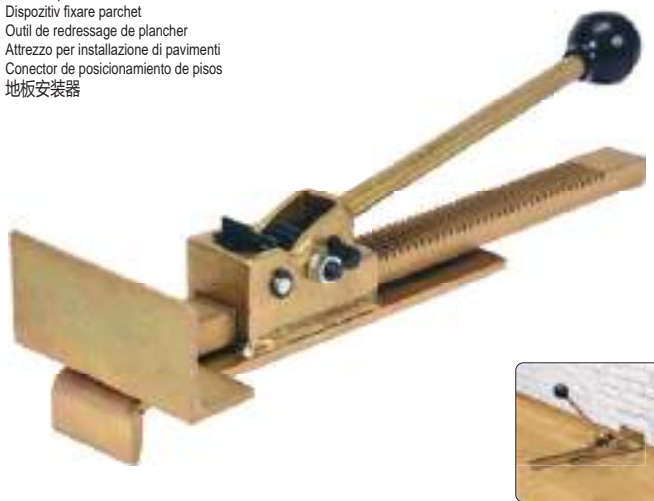

YATO **YT-37317** L [mm] 420 6

EN Floor plank cutter
 PL Gilotylna do cięcia wykładzin z PVC
 DE PVC-Streifenschneider
 RU Гильотина для резки напольных покрытий из ПВХ
 CZ Gilotylna pro řezání podlahových krytín z PVC
 HU PVC padló vágó kés
 RO Cutter parchet
 FR Coupe-bandes PVC
 IT Taglierino per rivestimenti in PVC
 ES Guillotina-cizalla para suelos de PVC
 CN 木地板切割器

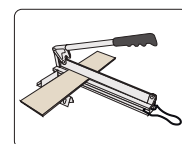

• Application: PVC, laminates, rubber, plastics
 • Zastosowanie: PVC, laminaty, gumy, tworzywa sztuczne

EN Floor laminate cutter
 PL Gilotylna do cięcia paneli podłogowych
 DE Laminat-Schneider
 RU Гильотина для ламината
 CZ Nůžky na laminátové plovoucí podlahy
 HU Laminált padló vágógép
 RO Aparat de tăiat parchet laminat
 FR Guillotine pour couper les panneaux
 IT Ghigliottina per taglio dei pannelli
 ES Guillotina cortapaneles
 CN 木地板切割器

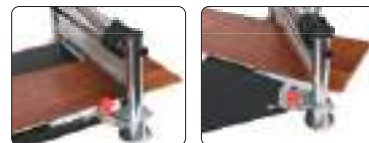

• Application: PVC, laminates, rubber, plastics
 • Zastosowanie: PVC, laminaty, gumy, tworzywa sztuczne

YATO **YT-37311** L [mm] 600 2

EN Deck board straightening tool
 PL Dociągacz desek podłogowych
 DE Terrassendielen-Richtwerkzeug
 RU Инструмент для стяжки досок пола
 CZ Montážní páka na podlahové desky
 HU Padlódeszka megkötő eszköz
 RO Instrument de îndreptat scânduri de terasă
 FR Outil de redressage de plancher
 IT Attrezzo per installazione di pavimenti
 ES Herramienta para apretar tablas para suelos
 CN 甲板矫正工具





YATO **YT-62930** L [mm] 670 10

YATO **YT-37325** 12

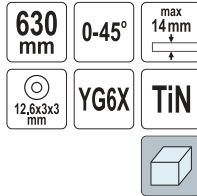
EN Tile cutter
PL Przyrząd do cięcia glazury
DE Fliesenschneider
RU Плиткорез
CZ Přístroj na řezání glazury
HU Csempévágó
RO Mașină pt. tăiat faianța
FR Coupeuse pour céramique
IT Taglierina per piastrelle
ES Cortadora de cerámica
CN 瓷砖切割器





YATO 	L [mm]	
YT-3703	630	2

EN Tile cutter
PL Przyrząd do cięcia glazury
DE Fliesenschneider
RU Плиткорез
CZ Přístroj na řezání glazury
HU Csempévágó

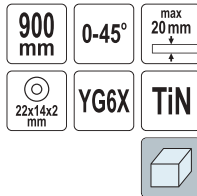
RO Mașină pt. tăiat faianța
FR Coupeuse pour céramique
IT Taglierina per piastrelle
ES Cortadora de cerámica
CN 瓷砖切割器



YATO 	L [mm]	
YT-3705	900	1

EN Tile cutting wheel
PL Kółko tnące wymienne
DE Schneiderrad
RU Ролик для плиткореза
CZ Výměnné kolečko
HU Cseregörgő csavarral

RO Cuțit rolă
FR Molette coupante avec barre
IT Lama di ricambio tondo
ES Recambio de cuchillo redondo
CN 瓷砖切割轮



For YT-3704, YT-3705, YT-3706, YT-3707, YT-3708
Dia YT-3704, YT-3705, YT-3706, YT-3707, YT-3708

YATO 	
YT-3714	50/200

EN Tile cutter
PL Przyrząd do cięcia glazury
DE Fliesenschneider
RU Плиткорез
CZ Přístroj na řezání glazury
HU Csempévágó

RO Mașină pt. tăiat faianța
FR Coupeuse pour céramique
IT Taglierina per piastrelle
ES Cortadora de cerámica
CN 瓷砖切割器

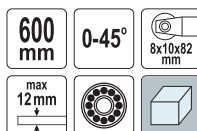

YATO 	L [mm]	
YT-37036	600	3

EN Tile cutting wheel
PL Kółko tnące wymienne
DE Schneiderrad
RU Ролик для плиткореза
CZ Výměnné kolečko
HU Cseregörgő csavarral

RO Cuțit rolă
FR Molette coupante avec barre
IT Lama di ricambio tondo
ES Recambio de cuchillo redondo
CN 瓷砖切割轮



For YT-3700, YT-3701, YT-3702
Dia YT-3700, YT-3701, YT-3702

YATO 	
YT-3712	50/250

EN Tile cutting wheel
PL Kółko tnące wymienne
DE Schneiderrad
RU Ролик для плиткореза
CZ Výměnné kolečko
HU Cseregörgő csavarral

RO Cuțit rolă
FR Molette coupante avec barre
IT Lama di ricambio tondo
ES Recambio de cuchillo redondo
CN 瓷砖切割轮

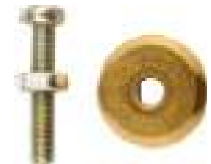



For YT-3703
Dia YT-3703

YATO 	
YT-3713	50/200

EN Tile cutter
PL Przyrząd do cięcia glazury
DE Fliesenschneider
RU Плиткорез
CZ Přístroj na řezání glazury
HU Csempévágó

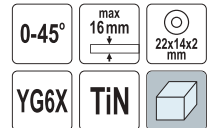
RO Mașină pt. tăiat faianța
FR Coupeuse pour céramique
IT Taglierina per piastrelle
ES Cortadora de cerámica
CN 瓷砖切割器



YATO 	L [mm]	
YT-3707	600	2
YT-3708	800	2

EN Tile cutting wheel
PL Kółko tnące wymienne
DE Schneiderrad
RU Ролик для плиткореза
CZ Výměnné kolečko
HU Cseregörgő csavarral

RO Cuțit rolă
FR Molette coupante avec barre
IT Lama di ricambio tondo
ES Recambio de cuchillo redondo
CN 瓷砖切割轮



For YT-3704, YT-3705, YT-3706, YT-3707, YT-3708
Dia YT-3704, YT-3705, YT-3706, YT-3707, YT-3708

YATO 	
YT-3714	50/200

EN Tile cutting wheel
PL Kółko tnące wymienne
DE Schneiderrad
RU Ролик для плиткореза

CZ Výměnné kolečko
HU Cseregörgő csavarral
RO Cuțit rolă
FR Molette coupante avec barre

IT Lama di ricambio tondo
ES Recambio de cuchillo redondo
CN 瓷砖切割轮



For YT-37034, YT-37036
Dia YT-37034, YT-37036

YATO 	
YT-37038	300

EN Tile cutter
 PL Przyrząd do cięcia glazury
 DE Fliesensneider
 RU Плиткорез
 CZ Přístroj na řezání glazury
 HU Csempévágó

RO Mașină pt. tăiat faianța
 FR Coupeuse pour céramique
 IT Taglierina per piastrelle
 ES Cortadora de cerámica
 CN 瓷砖切割器

800 mm

0-45°

22x6x6 mm

max 12 mm

CLASS / KLASA

2x AAA



EN Tile cutting wheel
 PL Kółko tnące wymienne
 DE Schneiderrad
 RU Ролик для плиткореза
 CZ Výměnné kolečko
 HU Cseregörgő csavarral

RO Cuțit rolă
 FR Molette coupante
 IT Lama di ricambio tondo
 ES Recambio de cuchillo redondo
 CN 瓷砖切割轮

22x6x6 mm

YG6X



YATO

L [mm]



YT-37022

800

2

YATO

YT-37150

50/500

EN Tile cutter
 PL Przyrząd do cięcia glazury
 DE Fliesensneider
 RU Плиткорез
 CZ Přístroj na řezání glazury
 HU Csempévágó

RO Mașină pt. tăiat faianța
 FR Coupeuse pour céramique
 IT Taglierina per piastrelle
 ES Cortadora de cerámica
 CN 瓷砖切割器

600 mm

max 12 mm

22x6x6 mm

AI



YATO

L [mm]



YT-37042

600

2

EN Tile cutter
 PL Przyrząd do cięcia glazury
 DE Fliesensneider
 RU Плиткорез
 CZ Přístroj na řezání glazury
 HU Csempévágó

RO Mașină pt. tăiat faianța
 FR Coupeuse pour céramique
 IT Taglierina per piastrelle
 ES Cortadora de cerámica
 CN 瓷砖切割器

1000 mm

max 16 mm

22x6x6 mm

YG6X



YATO

L [mm]



YT-37052

1000

1

EN Hand cutting system with connectable guide
 PL Przecinarka do płyt ceramicznych
 DE Keramikplattentrenmaschine
 RU Резак для керамической плитки
 CZ Rezačka keramických desek
 HU Csempévágó

RO Sistem de tăiere manuală cu ghidaj conectabil
 FR Coupe carrelage
 IT Troncatrice per pannelli di ceramica
 ES Cortador para placas de cerámica
 CN 薄板切割器

320 cm

max 3-8 mm

22 mm



YATO

L [mm]



YT-36980

3200

1

EN Tile cutter with table
 PL Przecinarka do płytek ceramicznych ze stołem
 DE Keramikfliesensneider mit Tisch
 RU Резак для керамической плитки со столом
 CZ Rezačka keramických dlaždic se stolem
 HU Csempévágó asztal

RO Aparat tăiat gresie, cu masa
 FR Scie à carreaux sur table
 IT Tagliapiastrelle a banco
 ES Cortador para baldosas cerámicas con mesa
 CN 瓷砖切割器

600 mm

max 14 mm

22x6x6 mm



YG6X



YATO

L [mm]



YT-37040



600

1



EN Tile cutting pliers
PL Szczypce do cięcia i łamania glazury
DE Glasurzange
RU Кусачки для плитки
CZ Kleště do glazury
HU Csempefogó
RO Cleste rupt faianta
FR Pince grès mosaïque
IT Tenaglia per piastrelle
ES Tenazas para azulejos
CN 瓷砖钳

200 mm YG6X 



YATO  L [mm] 
YT-37160 200 6/36

EN Tile cutting pliers
PL Szczypce do łamania glazury
DE Glasurzange
RU Кусачки для плитки
CZ Kleště do glazury
HU Csempefogó
RO Cleste rupt faianta
FR Pince grès mosaïque
IT Tenaglia per piastrelle
ES Tenazas para azulejos
CN 瓷砖钳

200 mm 2x  YG6X TiN 



YATO  L [mm] 
YT-37161 200 6/36

EN Tile cutting pliers
PL Szczypce do glazury
DE Glasurzange
RU Кусачки для плитки
CZ Kleště do glazury
HU Csempefogó
RO Cleste rupt faianta
FR Pince grès mosaïque
IT Tenaglia per piastrelle
ES Tenazas para azulejos
CN 瓷砖钳

200 mm YG6X 



YATO  L [mm] 
YT-37164 200 6/60

EN Tile chamfering machine
PL Prowadnica do fazowania płytek
DE Führung zum Anfasen von Fliesen
RU Направляющая для снятия фаски
CZ Vodičko pro srážení hran dlaždic
HU Vezetősín átíós csempevágáshoz
RO Dispozitiv pt. tesit placi
FR Dispositif de chanfreinage pour carrelage
IT Smussatrice per piastrelle
ES Máquina de biselado de azulejos
CN 瓷砖倒角器

250x170 mm 45° AI 



YATO  [mm] 
YT-36984 250x170 50

EN Grout remover
PL Skrobak do fug
DE Fugenreiniger
RU Скребок для швов кладки
CZ Škrabák na spáry
HU Fugakihűző
RO Răzuitoare pt. rosturi
FR Gratteur pour fugues
IT Raschietto per fuga piastrelle
ES Rascador para juntas
CN 砂浆去除器





YATO  
YT-37170 10/60

EN Interchangeable brick jointer
PL Przyrząd do wygładzania fug
DE Vorrichtung zum Glätten von Fugen
RU Инструмент для затирки швов
CZ Zařízení na vyhlazení spár
HU Fugasimító szerszám
RO Dispozitiv modelat rosturile dintre caramizi
FR Lisseur de joints
IT Attrezzo per levigare le giunzioni
ES Alisador de juntas
CN 墙缝刀

4 PCS 1/2" 5/8" 3/4" 7/8" SS 
12.7mm 15.9mm 19mm 22.2mm STAINLESS STEEL STALOWE IGLY



YATO  
YT-37177 6/24

EN Glaze bucket
PL Wiadro glazurnicze
DE Fliesenwaschset Rolleneimer
RU Ведро с роликами для затирки швов
CZ Malířské vědro
HU Fugázó vödör
RO Galeata pt. zugravit
FR Seau de peinture
IT Secchio per lavaggio piastrelle
ES Cubo de pintura
CN 釉桶

22L PE 



YATO  Capacity / Pojemność [l] 
YT-54750 22 42

EN Steel contour gauge
PL Wzornik do kopiowania kształtów
DE Profil Imuster
RU Шаблон профилей
CZ Profilová šablona
HU Profil sablon
RO Șablon profil
FR Jauges d'épaisseurs métriques
IT Sagoma di contorno
ES Plantilla de perfiles
CN 仿形规



150 mm 46 mm  STEEL NEEDLES STALOWE IGLY mm inch 

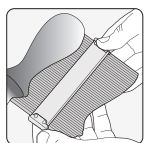

YATO  L [mm] 
YT-70870 150 12/48

EN Profile gauge
 PL Wzornik profili
 DE Profilmuster
 RU Шаблон профилей
 CZ Profilová šablona
 HU Profilsablón

RO Șablon profile
 FR Jauges d'épaisseurs métriques
 IT Profilato
 ES Plantilla de perfiles
 CN 轮廓仪



YATO	L [mm]	
YT-3735	125	24/72



YATO	L [mm]	
YT-3736	260	10/40

EN Trowel for silicone
 PL Szpachelka do silikonu
 DE Spachtel für Silikon
 RU Шпатель для силикона
 CZ Špachtle na silikon
 HU Spachli szilikonhoz
 RO Spatulă pt. silicon
 FR Spatule à silicone
 IT Spatola per silicone
 ES Espátula para silicona
 CN 橡塑刮板



YATO	
YT-5260	20/300

EN Trowel for silicone
 PL Szpachelka do silikonu
 DE Spachtel für Silikon
 RU Шпатель для силикона
 CZ Špachtle na silikon
 HU Spachli szilikonhoz
 RO Spatulă pt. silicon
 FR Spatule à silicone
 IT Spatola per silicone
 ES Espátula para silicona
 CN 橡塑刮板



YATO	
YT-5262	20/200

EN Stucco spatulas set
 PL Szpachelki sztukatorskie
 DE Stukkateureisen
 RU Шпатель штукатурный двухсторонний
 CZ Štukátorský nástroj
 HU Spatulák

RO Spatula metalica
 FR Spatule à moulures
 IT Set di spatole per stucco
 ES Espátulas
 CN 修正刀



YATO	
YT-52780	6/48

EN Profile gauge
 PL Wzornik profili
 DE Profilmuster
 RU Шаблон профилей
 CZ Profilová šablona
 HU Profilsablón

RO Șablon profile
 FR Jauges d'épaisseurs métriques
 IT Profilato
 ES Plantilla de perfiles
 CN 轮廓仪



YATO	L [mm]	
YT-37364	535	9/18

EN Trowel for silicone
 PL Szpachelka do silikonu
 DE Spachtel für Silikon
 RU Шпатель для силикона
 CZ Špachtle na silikon
 HU Spachli szilikonhoz
 RO Spatulă pt. silicon
 FR Spatule à silicone
 IT Spatola per silicone
 ES Espátula para silicona
 CN 橡塑刮板

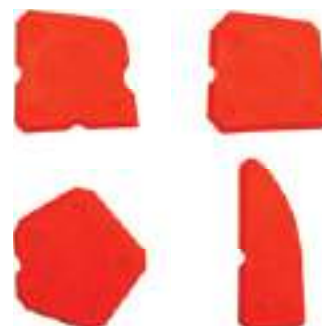

YATO	
YT-5261	20/200

EN Caulking tool set
 PL Zestaw narzędzi do fug silikonowych
 DE Fugenglätter Set
 RU Набор инструментов уплотнительных
 CZ Sada nástrojů pro spoje
 HU Az ízületek eszközei
 RO Un set de instrumente pt. rosturi
 FR Ensemble d'outils à calfeutrer
 IT Set di attrezzi per fughe in silicone
 ES Conjunto de herramientas para empalmes
 CN 钢丝刷

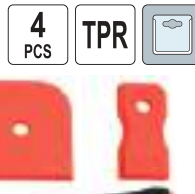

YATO	
YT-52621	12/48

EN Scraper with bits
 PL Szpachelka nierdzewna szlifowana
 DE Edelstahlspachtel geschliffen
 RU Шпатель из шлифованной нержавеющей стали
 CZ Špachtle z broušené nerezové oceli
 HU Csiszolt rozsdamentes spakli
 RO Racleta cu biti
 FR Spatule en acier inoxydable broyé
 IT Spatola in acciaio inossidabile rettificato
 ES Espátula inox esmerilada
 CN 油灰刀

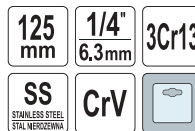

□ 1/4" (6.3 mm); 5, 6 mm (L=25 mm); CrV;
 ⊕ 1/4" (6.3 mm); PH2 (L=25 mm; 2 PCS); CrV

YATO	
YT-52760	10/60

EN Multi-funktion paint scraper
PL Skrobak malarski nierdzewny profilowany
DE Malerschaber rostfrei, profiliert
RU Скребок малярный из нержавеющей стали, профилированный
CZ Profilovaná malířská škrabka z nerezové oceli
HU Profilozott rozsdamentes festékkaparó
RO Racleta vopsea multifunctionala
FR Racloir à peinture profilé en acier inoxydable
IT Raschietto per vernice profilato inossidabile
ES Rasqueta de pintura inoxidable perfilada
CN 油灰刀



□ 1/4" (6.3 mm): 5, 6 mm (L=25 mm); CrV;
⊕ 1/4" (6.3 mm): PH2 (L=25 mm; 2 PCS); CrV

YATO		
YT-52870		12/144

EN Stainless steel putty knife
PL Szpachla nierdzewna
DE Edelstahl-Kleberspachtel
RU Шпатель из нержавеющей стали
CZ Nerezová špachtle
HU Rozsdamentes spatki
RO Spaclu inox pt. chituit
FR Spatule à enduire en inox
IT Spatola in acciaio inox
ES Espátula de acero inoxidable
CN 不锈钢刮刀



YATO	Working width / Szerokość robocza [mm]	
YT-52245	150	12/120
YT-52246	200	12/120
YT-52247	250	12/120

EN Finishing spatula
PL Szpachla wykończeniowa
DE Flächenspachtel
RU Финишный шпатель
CZ Špachtle fasádní
HU Glett leköz
RO Gletieră finisare
FR Couteau à lisser
IT Spatola lisciante per rasatura
ES Espátula para alisado
CN 刮刀



YATO	Working width / Szerokość robocza [mm]	
YT-52220	250	2
YT-52221	400	2
YT-52222	600	2
YT-52223	800	2
YT-52224	1000	2

EN Handle adapter for finishing spatula
PL Uchwyt do szpachli wykończeniowej
DE Adapter für Flächenspachtel
RU Ручка для финишных шпателей
CZ Adaptér pro fasádní špachtli
HU Glett leköz nyelezhető adapter
RO Adaptor maner pt. spatula finisare
FR Adaptateur de perche pour couteaux à lisser
IT Adattatore per spatola di finitura
ES Mango para espátula de acabado
CN 刮刀手柄



For YT-52220, YT-52221, YT-52222, YT-52223, YT-52230, YT-52231, YT-52232, YT-52233
Dla YT-52220, YT-52221, YT-52222, YT-52223, YT-52230, YT-52231, YT-52232, YT-52233

YATO		
YT-52237		4

EN Multi-funktion paint scraper
PL Skrobak malarski nierdzewny profilowany
DE Malerschaber rostfrei, profiliert
RU Скребок малярный из нержавеющей стали, профилированный
CZ Profilovaná malířská škrabka z nerezové oceli
HU Profilozott rozsdamentes festékkaparó
RO Racleta vopsea multifunctionala
FR Racloir à peinture profilé en acier inoxydable
IT Raschietto per vernice profilato inossidabile
ES Rasqueta de pintura inoxidable perfilada
CN 油灰刀

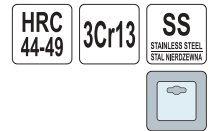

YATO		
YT-52871		12/144

EN Plastic scraper set
PL Zestaw skrobaków - szpachelki
DE Schaber-Spachtel-Satz
RU Набор скребков - шпатели
CZ Sada škrabek - špachtle
HU Kaparókészlet - spatulák
RO Set raclete din plastic
FR Jeu de raclettes et spatules
IT Kit di raschietti - spatole
ES Juego de raspadores - espátulas
CN 塑料油灰刀



6 PCS	40 mm
50 mm	80 mm
100 mm	150 mm
200 mm	ABS

YATO		
YT-52740		6/24

EN Finishing spatula
PL Szpachla wykończeniowa
DE Flächenspachtel
RU Финишный шпатель
CZ Špachtle fasádní
HU Glett leköz
RO Gletieră finisare
FR Couteau à lisser
IT Spatola lisciante per rasatura
ES Espátula para alisado
CN 刮刀



YATO	Working width / Szerokość robocza [mm]	
YT-52230	250	4
YT-52231	400	4
YT-52232	600	4
YT-52233	800	2
YT-52234	1000	2

EN Handle adapter for spatulas
PL Uchwyt na przedłużkę do szpachli
DE Stieladapter für Spachtel
RU Адаптер для шпателя
CZ Držák špachtle na tyč
HU Spakli nyelezhető adapter
RO Maner cu adaptor pt. spatule
FR Adaptateur de manche pour spatules
IT Adattatore per spatola
ES Adaptador de mango para espátula
CN 刮刀手柄



For YT-5226, YT-5228, YT-5230, YT-52310, YT-52311, YT-52312, YT-52313, YT-52314, YT-52320
Dla YT-5226, YT-5228, YT-5230, YT-52310, YT-52311, YT-52312, YT-52313, YT-52314, YT-52320

YATO		
YT-52317		4

EN Replaceable blade for finishing spatula
 PL Ostrze do szpachli wykończeniowej
 DE Ersatzblatt für Flächenspachtel
 RU Лезвие для финишного шпателя
 CZ Náhradní čepel do špachtle fasádní
 HU Cserélhető penge glett lehozóhoz

RO Lamă de înlocuit pt. gletieră finisare
 FR Lame pour couteaux à lisser
 IT Lama per spatola lisciante
 ES Cuchilla de recambio para espátula de alisado
 CN 刮墙板刀片



YATO	W [mm]	For / Dla	
YT-52240	250	YT-52230	5
YT-52241	400	YT-52231	5
YT-52242	600	YT-52232	5
YT-52243	800	YT-52233	5
YT-52244	1000	YT-52224, YT-52234	5

EN Gypsum container
 PL Pojemnik na gips
 DE Gipsbehälter
 RU Контейнер для гипса
 CZ Nádoba na sádro
 HU Gipsztál
 RO Recipient de gips
 FR Conteneur rond pour préparation de plâtre
 IT Recipiente per gesso
 ES Contenedor para yeso
 CN 石膏桶



83 mm
 130 mm
 0.5 L

YATO		
YT-51881	0.5	20

EN Trowel
 PL Paca
 DE Reibebrett
 RU Терка
 CZ Hladitko
 HU Glettelő

RO Gletieră
 FR Truelle
 IT Frattazzo
 ES Llana
 CN 抹子

SS
 STAINLESS STEEL
 STAL NERDZEWNA



• Made of special cold rolled stainless steel sheet with elasticity factor up to 2000 N/mm
 • Części robocze ze specjalnej zimnowalcowanej blachy nierdzewnej o sprężystości do 2000 N/mm

YATO	Size / Rozmiar [mm]	
YT-5200	270x130	30

EN Trowel
 PL Paca
 DE Reibebrett
 RU Терка
 CZ Hladitko
 HU Glettelő

RO Gletieră
 FR Truelle
 IT Frattazzo
 ES Llana
 CN 抹子

SS
 STAINLESS STEEL
 STAL NERDZEWNA



• Made of special cold rolled stainless steel sheet with elasticity factor up to 2000 N/mm
 • Części robocze ze specjalnej zimnowalcowanej blachy nierdzewnej o sprężystości do 2000 N/mm

YATO	Size / Rozmiar [mm]	
YT-5207	380x130	10
YT-5209	480x130	10
YT-5210	580x130	10

EN Gypsum container
 PL Pojemnik na gips
 DE Gipsbehälter
 RU Контейнер для гипса
 CZ Nádoba na sádro
 HU Gipsztál
 RO Recipient de gips
 FR Conteneur rond pour préparation de plâtre
 IT Recipiente per gesso
 ES Contenedor para yeso
 CN 石膏桶

50 mm
 155 mm
 0.5 L



YATO		
YT-51880	0.5	20

EN Stainless steel scraper set
 PL Szpachelki nierdzewne "japonki"
 DE Aufstreichspachtel
 RU Набор шпателей тип "Японский"
 CZ Špachtle japonsky nerezavějící
 HU Spatula rozsdamentes
 RO Șpacluri japoneze inoxidabile
 FR Racleur en acier inoxydable ensemble
 IT Spatole giapponesi in acciaio inox
 ES Espátulas "japonesas" de acero
 CN 刮刀



YATO		
YT-52790		10/40

EN Trowel
 PL Paca
 DE Reibebrett
 RU Терка

CZ Hladitko
 HU Glettelő
 RO Gletieră
 FR Truelle

IT Frattazzo
 ES Llana
 CN 抹子

SS
 STAINLESS STEEL
 STAL NERDZEWNA



• Made of special cold rolled stainless steel sheet with elasticity factor up to 2000 N/mm
 • Części robocze ze specjalnej zimnowalcowanej blachy nierdzewnej o sprężystości do 2000 N/mm

YATO	Teeth size / Rozmiar zębów [mm]	Size / Rozmiar [mm]	
YT-5202	6x6	275x130	30
YT-5203	8x8	270x130	30
YT-5204	10x10	260x130	30

EN Trowel
 PL Paca
 DE Reibebrett
 RU Терка
 CZ Hladitko
 HU Glettelő
 RO Gletieră
 FR Truelle
 IT Frattazzo
 ES Llana
 CN 抹子



YATO	L [mm]	
YT-5212	500	20

EN Bull float kit
PL Ręczna listwa wibracyjna
DE Handgehaltener Vibrationsstab
RU Ручная виброрейка
CZ Ruční vibrační lišta
HU Kézi betonlehúzó
RO Dispozitiv nivelat sapa
FR Règle à vibrations portative
IT Regola vibrante manuale
ES Regla vibratoria manual
CN 抹子

120x20
cm

AI

3x180cm



YATO 

Size / Rozmiar [mm]



YT-30900

1200x200

1

EN Trowel
PL Paca
DE Reibebrett
RU Терка
CZ Hladitko
HU Glettelő
RO Gletieră
FR Truelle
IT Frattazzo
ES Llana
CN 抹子

SS
STAINLESS STEEL
STA. NERZIEHN



• Made of special cold rolled stainless steel sheet with elasticity factor up to 2000 N/mm

• Części robocze ze specjalnej zimnowalcowanej blachy nierdzewnej o sprężystości do 2000 N/mm

YATO 

Size / Rozmiar [mm]



YT-5214

200x80

20

EN Trowel
PL Paca
DE Reibebrett
RU Терка
CZ Hladitko
HU Glettelő
RO Gletieră
FR Truelle
IT Frattazzo
ES Llana
CN 抹子



YATO 

Size / Rozmiar [mm]



YT-51900

250x95

5

EN Trowel
PL Paca
DE Reibebrett
RU Терка
CZ Hladitko
HU Glettelő
RO Gletieră
FR Truelle
IT Frattazzo
ES Llana
CN 抹子

18
mm



YATO 

Size / Rozmiar [mm]



YT-51909

270x130

10

EN Trowel
PL Paca
DE Reibebrett
RU Терка
CZ Hladitko
HU Glettelő
RO Gletieră
FR Truelle
IT Frattazzo
ES Llana
CN 抹子

8
mm



YATO 

Size / Rozmiar [mm]



YT-51901

270x130

10

EN Trowel
PL Paca
DE Reibebrett
RU Терка
CZ Hladitko
HU Glettelő
RO Gletieră
FR Truelle
IT Frattazzo
ES Llana
CN 抹子

40
mm



YATO 

Size / Rozmiar [mm]



YT-51902

270x130

10

EN Trowel
PL Paca
DE Reibebrett
RU Терка
CZ Hladitko
HU Glettelő
RO Gletieră
FR Truelle
IT Frattazzo
ES Llana
CN 抹子

40
mm



YATO 

Size / Rozmiar [mm]



YT-51903

270x130

10

EN Trowel
PL Paca
DE Reibebrett
RU Терка
CZ Hladitko
HU Glettelő
RO Gletieră
FR Truelle
IT Frattazzo
ES Llana
CN 抹子



YATO Size / Rozmiar [mm] 10
YT-51904 270x130

EN Trowel
PL Paca
DE Reibebrett
RU Терка
CZ Hladitko
HU Glettelő
RO Gletieră
FR Truelle
IT Frattazzo
ES Llana
CN 抹子



YATO Size / Rozmiar [mm] 10
YT-51905 270x130

EN Trowel
PL Paca
DE Reibebrett
RU Терка
CZ Hladitko
HU Glettelő
RO Gletieră
FR Truelle
IT Frattazzo
ES Llana
CN 抹子



YATO Size / Rozmiar [mm] 10
YT-51906 270x130

EN Trowel
PL Paca
DE Reibebrett
RU Терка
CZ Hladitko
HU Glettelő
RO Gletieră
FR Truelle
IT Frattazzo
ES Llana
CN 抹子



YATO Size / Rozmiar [mm] 5
YT-51907 270x130

EN Trowel
PL Paca
DE Reibebrett
RU Терка
CZ Hladitko
HU Glettelő
RO Gletieră
FR Truelle
IT Frattazzo
ES Llana
CN 抹子



YATO Size / Rozmiar [mm] 10
YT-51908 270x130

EN Trowel
PL Paca
DE Reibebrett
RU Терка
CZ Hladitko
HU Glettelő
RO Gletieră
FR Truelle
IT Frattazzo
ES Llana
CN 抹子



YATO Size / Rozmiar [mm] 10
YT-51910 270x130

EN Trowel
PL Paca
DE Reibebrett
RU Терка
CZ Hladitko
HU Glettelő
RO Gletieră
FR Truelle
IT Frattazzo
ES Llana
CN 抹子



YATO Size / Rozmiar [mm] 20
YT-51911 270x130

EN Rasp for polystyrene
PL Tarka do styropianu
DE Reibebrett für Styropor
RU Терка для пенопласта
CZ Rašple na polystyren
HU Polisztirol reszelő
RO Gletieră pt. răzuit polistiren
FR Planche à poncer pour polystyrène
IT Raspa per polistirolo
ES Escofina para poliestireno
CN 多孔砂板

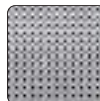

YATO Size / Rozmiar [mm] 10
YT-51920 375x155

- EN Rasp for polystyrene
PL Tarka do styropianu
DE Reibebrett für Styropor
RU Терка для пенопласта
CZ Rašple na polystyren
HU Polisztirol reszelő
RO Gletteră pt. răzuît polistiren
FR Planche à poncer pour polystyrène
IT Raspa per polistirolo
ES Escofina para poliestireno
CN 多孔砂板



YATO	Size / Rozmiar [mm]	
YT-5218	370x165	20

- EN Facade putty knife
PL Szpachla fasadowa
DE Flächenspachtel
RU Шпатель фасадный
CZ Špachtle fasádní
HU Fali spatulya
RO Spaclu inox
FR Spatule de façade
IT Spatola per facciate
ES Espátula de fachada
CN 剥皮刀



YATO	Size / Rozmiar [mm]	
YT-52310	150x90	10
YT-52311	250x90	10
YT-52312	350x90	10
YT-52313	450x90	10
YT-52314	550x90	10

- EN Trowel
PL Kielnia
DE Kelle
RU Кельма
CZ Lžíce
HU Vakolókanál
RO Mistrie
FR Truelle
IT Cazzuola
ES Paleta
CN 抹子



- Made of special cold rolled stainless steel sheet with elasticity factor up to 2000 N/mm
- Części robocze ze specjalnej zimnowalcowanej blachy nierdzewnej o sprężystości do 2000 N/mm

YATO	Dimensions / Wymiary [mm]	
YT-5237	120x180x80	10

- EN Trowel
PL Kielnia
DE Kelle
RU Кельма
CZ Lžíce
HU Vakolókanál
RO Mistrie
FR Truelle
IT Cazzuola
ES Paleta
CN 抹子



- Made of special cold rolled stainless steel sheet with elasticity factor up to 2000 N/mm
- Części robocze ze specjalnej zimnowalcowanej blachy nierdzewnej o sprężystości do 2000 N/mm

YATO	Size / Rozmiar [mm]	
YT-5242	100x130	20
YT-5243	80x110	20

- EN Facade putty knife
PL Szpachla fasadowa
DE Flächenspachtel
RU Шпатель фасадный
CZ Špachtle fasádní
HU Fali spatulya
- RO Spaclu inox
FR Spatule de façade
IT Spatola per facciate
ES Espátula de fachada
CN 剥皮刀



- Made of special cold rolled stainless steel sheet with elasticity factor up to 2000 N/mm
- Części robocze ze specjalnej zimnowalcowanej blachy nierdzewnej o sprężystości do 2000 N/mm

YATO	L [mm]	
YT-5226	250	20
YT-5228	350	20
YT-5230	500	20

- EN Trowel
PL Kielnia
DE Kelle
RU Кельма
CZ Lžíce
HU Vakolókanál
RO Mistrie
FR Truelle
IT Cazzuola
ES Paleta
CN 抹子



- Made of special cold rolled stainless steel sheet with elasticity factor up to 2000 N/mm
- Części robocze ze specjalnej zimnowalcowanej blachy nierdzewnej o sprężystości do 2000 N/mm

YATO	Size / Rozmiar [mm]	
YT-5234	200x190	10

- EN Trowel
PL Kielnia
DE Kelle
RU Кельма
CZ Lžíce
HU Vakolókanál
RO Mistrie
FR Truelle
IT Cazzuola
ES Paleta
CN 抹子



- Made of special cold rolled stainless steel sheet with elasticity factor up to 2000 N/mm
- Części robocze ze specjalnej zimnowalcowanej blachy nierdzewnej o sprężystości do 2000 N/mm

YATO	Dimensions / Wymiary [mm]	
YT-5240	165x80x55	20

- EN Trowel
PL Kielnia
DE Kelle
RU Кельма
CZ Lžíce
HU Vakolókanál
RO Mistrie
FR Truelle
IT Cazzuola
ES Paleta
CN 抹子



- Made of special cold rolled stainless steel sheet with elasticity factor up to 2000 N/mm
- Części robocze ze specjalnej zimnowalcowanej blachy nierdzewnej o sprężystości do 2000 N/mm

YATO	Size / Rozmiar [mm]	
YT-5245	135x80	20

- EN Curved edge bucket scoop
- PL Szpachla profilowana do wiadra
- DE Eimerschaber
- RU Шпатель для ведра
- CZ Profilovaná štěrka na kbelíky
- HU Ívelt kisedő spakli
- RO Spaclu curbat pt. galeata
- FR Stucateur pour seau
- IT Spatola inclinata lama arrotondata per secchio
- ES Espátula para limpieza de cubeta
- CN 圆弧铲



165 mm

YATO	Working width / Szerokość robocza [mm]	
YT-52320	165	4

- EN Plaster scrubber
- PL Zdzierak do tynków
- DE Alu-Rabott
- RU Треугольный мастерок для каменщиков
- CZ Škrabák
- HU Vakolat gyalu alu késes
- RO Gletiera abraziva
- FR Enleveur du badigeon
- IT Utensile per sgrossare
- ES Rascador para enlucido
- CN 石膏去除器



YATO	Size / Rozmiar [mm]	
YT-52471	248x133	10

- EN Scraper for plaster and aerated blocks
- PL Zdzierak wyrównujący
- DE Gipshobel mit Stahlklingen
- RU Рубанок для газобетона
- CZ Vyrovnávací škrabák
- HU Kiegyenlítő dörzsölő
- RO Raspel de nivelare
- FR Lime grosse droit
- IT Raschiatore livellatore
- ES Raspador
- CN 干墙器



YATO	Size / Rozmiar [mm]	
YT-52472	405x84	10

- EN Scraper with teeth for plaster and aerated blocks
- PL Zdzierak wyrównujący z ząbkami
- DE Gipshobel mit Stahlklingen gezahnt
- RU Рубанок для газобетона зубчатый
- CZ Vyrovnávací škrabák se zoubky
- HU Fogas, kiegyenlítő dörzsölő
- RO Raspel cu dinți
- FR Lime grosse droit avec dents
- IT Raschiatore livellatore dentato
- ES Raspador con dientes
- CN 干墙器



YATO	Size / Rozmiar [mm]	
YT-52473	405x84	10

- EN Plaster scrubber
- PL Zdzierak do tynków
- DE Alu-Rabott
- RU Треугольный мастерок для каменщиков
- CZ Škrabák
- HU Vakolat gyalu alu késes

- RO Gletiera abraziva
- FR Enleveur du badigeon
- IT Utensile per sgrossare
- ES Rascador para enlucido
- CN 石膏去除器



AI

YATO	Size / Rozmiar [mm]	
YT-5247	450x90	25

- EN Mortar gun with nozzles kit
- PL Wyciskacz do fugowania
- DE Mörtelspritze
- RU Пистолет для затирки швов
- CZ Pistole vytláčovací
- HU Kinyomó pisztoly
- RO Pistol pt. silicon
- FR Seringue mortier
- IT Pistola per silicone
- ES Pistola para calafatear mortero
- CN 堵缝枪



YATO	
YT-67580	10

- EN Mortar gun with nozzles kit
- PL Wyciskacz do fugowania
- DE Mörtelspritze
- RU Пистолет для затирки швов
- CZ Pistole vytláčovací
- HU Kinyomó pisztoly
- RO Pistol pt. silicon
- FR Seringue mortier
- IT Pistola per silicone
- ES Pistola para calafatear mortero
- CN 堵缝枪



1L AI

YATO	
YT-67583	12

- EN Plaster / stucco spray gun
- PL Tynkowica pneumatyczna do ścian
- DE Spritzpistole für Mörtel
- RU Пневмоковш для штукатурки стен
- CZ Strikací pistole pro maltu
- HU Habarcis szórópisztoly

- RO Spray pistol pt. mortar
- FR Pistolet à peinture pour mortier
- IT Intonacatrice pneumatica per pareti
- ES Pistola pulverizadora para mortero
- CN 重型气动便携式墙面水泥砂浆喷枪

0.4-0.8 MPa 400 l/min
4.75L max 50 m³/h
 STANDARD



L_{PA} = 93,6 ± 2,5 dB; L_{WA} = 104,6 ± 2,5 dB; a_n = <2,5 m/s²

YATO	
YT-54400	4

- EN Spiked soles for work shoes
- PL Podeszwy z kolcami
- DE Sohlen mit Spikes
- RU Подошвы с шипами
- CZ Podesšve s hroty
- HU Szögcs cipőtalp
- RO Talpi cu tepi pt. sapa
- FR Semelles à pointes
- IT Sottoscarpe chiodate
- ES Suelos con clavos
- CN 草地鞋

300 mm TTTT 45mm



YATO	L [mm]	
YT-80820	300	20

EN Stamp roller
PL Walek do wyciskania wzorów w tynku
DE Musterpressrolle für Putz
RU Валик для выдавливания рисунков в штукатурке
CZ Váleček pro vytlačení vzorů na omítkách
HU Henger minták dombornyomásához a vakolatban
RO Trafalet cu model
FR Rouleau texturé pour plâtre
IT Rullo goffratore per intonaco
ES Rodillo con relieve para enlucidos
CN 橡胶压花滚筒

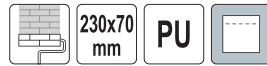

230x70
mm

PU



YATO 

Size / Rozmiar [mm]



YT-51960

230x70

25

EN Stamp roller
PL Walek do wyciskania wzorów w tynku
DE Musterpressrolle für Putz
RU Валик для выдавливания рисунков в штукатурке
CZ Váleček pro vytlačení vzorů na omítkách
HU Henger minták dombornyomásához a vakolatban
RO Trafalet cu model
FR Rouleau texturé pour plâtre
IT Rullo goffratore per intonaco
ES Rodillo con relieve para enlucidos
CN 橡胶压花滚筒



230x70
mm

PU



YATO 

Size / Rozmiar [mm]



YT-51961

230x70

25

EN Stamp roller
PL Walek do wyciskania wzorów w tynku
DE Musterpressrolle für Putz
RU Валик для выдавливания рисунков в штукатурке
CZ Váleček pro vytlačení vzorů na omítkách
HU Henger minták dombornyomásához a vakolatban
RO Trafalet cu model
FR Rouleau texturé pour plâtre
IT Rullo goffratore per intonaco
ES Rodillo con relieve para enlucidos
CN 橡胶压花滚筒



230x70
mm

PU



YATO 

Size / Rozmiar [mm]



YT-51962

230x70

25

EN Stamp roller
PL Walek do wyciskania wzorów w tynku
DE Musterpressrolle für Putz
RU Валик для выдавливания рисунков в штукатурке
CZ Váleček pro vytlačení vzorů na omítkách
HU Henger minták dombornyomásához a vakolatban
RO Trafalet cu model
FR Rouleau texturé pour plâtre
IT Rullo goffratore per intonaco
ES Rodillo con relieve para enlucidos
CN 橡胶压花滚筒



180x70
mm

PU



YATO 

Size / Rozmiar [mm]



YT-51963

180x70

25

EN Stamp roller
PL Walek do wyciskania wzorów w tynku
DE Musterpressrolle für Putz
RU Валик для выдавливания рисунков в штукатурке
CZ Váleček pro vytlačení vzorů na omítkách
HU Henger minták dombornyomásához a vakolatban
RO Trafalet cu model
FR Rouleau texturé pour plâtre
IT Rullo goffratore per intonaco
ES Rodillo con relieve para enlucidos
CN 橡胶压花滚筒

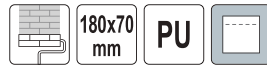

180x70
mm

PU



YATO 

Size / Rozmiar [mm]



YT-51964

180x70

25

EN Multi-purpose brush
PL Szczotka do tynków dekoracyjnych
DE Bürste für Dekorationsputz
RU Щетка для декоративной штукатурки
CZ Štětká do dekoracních omítek
HU Dekoratív vakolatához való kefe
RO Perie
FR Brosse multi-fonctions
IT Spazzola per effetti decorativi di intonaco
ES Escoba para enlucidos decorativos
CN 万用刷



YATO 

Size / Rozmiar [mm]



YT-51970

400x25

50

YT-51971

200x25

50

EN Multi-purpose brush
PL Szczotka do tynków dekoracyjnych
DE Bürste für Dekorationsputz
RU Щетка для декоративной штукатурки
CZ Štětká do dekoracních omítek
HU Dekoratív vakolatához való kefe

RO Perie
FR Brosse multi-fonctions
IT Spazzola per effetti decorativi di intonaco
ES Escoba para enlucidos decorativos
CN 万用刷

140x235
mm



YATO 

Size / Rozmiar [mm]



YT-51973

140x235

40

EN Self-adhesive protective film
PL Folia ochronna samoprzylepna
DE Selbstklebende Schutzfolie
RU Самоклеящаяся пленка
CZ Ochranná samolepicí folie
HU Őntapadás védőfólia
RO Folie protecție autoadezivă
FR Film de protection auto-adhésif
IT Pellicola protettiva adesiva
ES Película protectora autoadhesiva
CN 自粘保护膜



YATO 

W [cm]

L [m]

± [μm]



YT-54300

25

30

45

12

YT-54310

50

30

45

6

YT-54313

50

75

45

6

YT-54320

60

50

45



4

EN Flat paint brush
 PL Pędzel angielski
 DE Flachpinsel
 RU Кисть флейцевая тип Английский
 CZ Štětec anglický
 HU Laposecset

RO Pensulă englezească
 FR Pinceau plat anglais
 IT Pennello piatto
 ES Brocha plana
 CN 平刷



• Application: oil, emulsion, latex and ceramic paints, impregnating paint, varnish
 • Zastosowanie: farby olejne, emulsyjne, lateksowe i ceramiczne, impregnaty, lakiery



YATO 	Brush width / Szerokość pędzla	
YT-54500	1" (25 mm)	12
YT-54501	1.5" (38 mm)	12
YT-54502	2" (50 mm)	12
YT-54503	2.5" (63 mm)	12
YT-54504	3" (76 mm)	12
YT-54505	4" (100 mm)	12

EN Flat paint brush
 PL Pędzel angielski
 DE Flachpinsel
 RU Кисть флейцевая тип Английский
 CZ Štětec anglický
 HU Laposecset

RO Pensulă englezească
 FR Pinceau plat anglais
 IT Pennello piatto
 ES Brocha plana
 CN 平刷



• Application: oil, emulsion, latex and ceramic paints, impregnating paint, varnish
 • Zastosowanie: farby olejne, emulsyjne, lateksowe i ceramiczne, impregnaty, lakiery



YATO 	Brush width / Szerokość pędzla	
YT-54550	1" (25 mm)	12
YT-54551	1.5" (38 mm)	12
YT-54552	2" (50 mm)	12
YT-54553	2.5" (63 mm)	12
YT-54554	3" (76 mm)	12

EN Round paint brush
 PL Pędzel pierścieniowy
 DE Ringpinsel
 RU Кисть круглая
 CZ Kulatý štětec
 HU Marokcset

RO Pensula rotundă
 FR Pinceau rond
 IT Pennello circolare
 ES Brocha redonda
 CN 圆刷



• Application: oil, emulsion, latex and ceramic paints, impregnating paint, varnish
 • Zastosowanie: farby olejne, emulsyjne, lateksowe i ceramiczne, impregnaty, lakiery



YATO 	Brush width / Szerokość pędzla [mm]	
YT-54580	35	12
YT-54581	40	12
YT-54582	50	12
YT-54583	60	12

EN Angled paint brush
 PL Pędzel kątowy
 DE Heizkörperpinsel
 RU Кисть радиаторная
 CZ Úhlová štětec
 HU Radiátorecset

RO Pensula pt. calorifere
 FR Pinceau à radiateur
 IT Pennello ad angolo
 ES Brocha angularada de radiadores
 CN 平刷



• Application: oil, emulsion, latex and ceramic paints, impregnating paint, varnish
 • Zastosowanie: farby olejne, emulsyjne, lateksowe i ceramiczne, impregnaty, lakiery



YATO 	Brush width / Szerokość pędzla	
YT-54620	1.5" (38 mm)	12
YT-54621	2" (50 mm)	12
YT-54622	2.5" (63 mm)	12

EN Flat paint brush
 PL Pędzel angielski
 DE Flachpinsel
 RU Кисть флейцевая тип Английский
 CZ Štětec anglický
 HU Laposecset

RO Pensulă englezească
 FR Pinceau plat anglais
 IT Pennello piatto
 ES Brocha plana
 CN 平刷



• Application: oil, emulsion, latex and ceramic paints, impregnating paint, varnish
 • Zastosowanie: farby olejne, emulsyjne, lateksowe i ceramiczne, impregnaty, lakiery



YATO 	Brush width / Szerokość pędzla	
YT-54540	1" (25 mm)	12
YT-54541	1.5" (38 mm)	12
YT-54542	2" (50 mm)	12
YT-54543	2.5" (63 mm)	12
YT-54544	3" (76 mm)	12

EN Flat paint brush
 PL Pędzel angielski
 DE Flachpinsel
 RU Кисть флейцевая тип Английский
 CZ Štětec anglický
 HU Laposecset

RO Pensulă englezească
 FR Pinceau plat anglais
 IT Pennello piatto
 ES Brocha plana
 CN 平刷



• Application: oil, emulsion, latex and ceramic paints, impregnating paint, varnish
 • Zastosowanie: farby olejne, emulsyjne, lateksowe i ceramiczne, impregnaty, lakiery



YATO 	Brush width / Szerokość pędzla	
YT-54560	1" (25 mm)	12
YT-54561	1.5" (38 mm)	12
YT-54562	2" (50 mm)	12
YT-54563	2.5" (63 mm)	12
YT-54564	3" (76 mm)	12

EN Round paint brush
 PL Pędzel okrągły
 DE Ringpinsel
 RU Кисть круглая
 CZ Kulatý štětec
 HU Marokcset

RO Pensula rotundă
 FR Pinceau rond
 IT Pennello rotondo
 ES Brocha redonda
 CN 圆刷





• Application: oil, emulsion, latex and ceramic paints, impregnating paint, varnish
 • Zastosowanie: farby olejne, emulsyjne, lateksowe i ceramiczne, impregnaty, lakiery

YATO 	Brush width / Szerokość pędzla [mm]	
YT-54590	16	12
YT-54591	23	12
YT-54592	29	12
YT-54593	33	12

EN Wall brush
 PL Pędzel tapetowy
 DE Flächenstreicher
 RU Кисть макловица
 CZ Štětec na tapety dřevěný
 HU Ecset fa tapétákhoz
 RO Bidinea pt. tapet
 FR La brosse à peinture rectangulaire
 IT Pennello per carta da parati
 ES Brocha de empapelar madero
 CN 平刷



• Application: oil, emulsion, latex and ceramic paints, impregnating paint, varnish
 • Zastosowanie: farby olejne, emulsyjne, lateksowe i ceramiczne, impregnaty, lakiery

YATO 	Size / Rozmiar [mm]	
YT-54640	110x30	2
YT-54641	140x40	2
YT-54642	150x50	2

EN Paint bucket
PL Kuwotka malarska
DE Farbschale
RU Ковш для краски
CZ Malířská vanička
HU Kúvetta
RO Tavă suport trafalet
FR Seau de peinture
IT Ciotola per vernice
ES Cubeta para rodillo
CN 颜料碗



YATO	
YT-54730	80

EN Paint mixer
PL Mieszadło do farb ręczne
DE Manueller Farbmischer
RU Мешалка для красок
CZ Míchadlo na hmoty
HU Keverő festékekhez

RO Mixer vopsea
FR Mélangeur pour peintures
IT Miscelatore manuale per vernici
ES Mezclador para pinturas
CN 油漆搅拌机



YATO	
YT-54670	50

EN Dust protection door type "U"
PL Osłona przeciwpylowa - drzwi foliowe typu "U"
DE Folien-Staubschutztür, U-Form
RU Пылезащитная пленка - пленочная дверь типа "U"
CZ Protiprachový kryt - fóliové dveře typu "U"
HU Porvédelem - "U" típusú fóliaajtó
RO Ușă de protecție împotriva prafului tip "U"
FR Pare-poussière - porte en plastique de type "U"
IT Protezione antipolvere - porta in pellicola tipo "U"
ES Puerta de protección antipolvo tipo "U"
CN 塑料装修防尘门

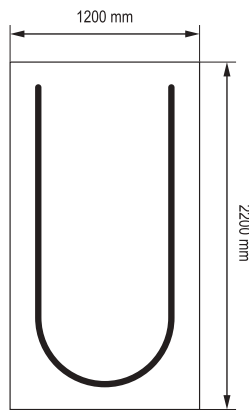
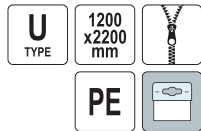

YATO	Size / Rozmiar [mm]	
YT-67220	1200x2200	12

EN Tile adjuster
PL Podnośnik do unoszenia płytek
DE Fliesenheber
RU Лебедка для поднятия плитки
CZ Zvedák k zvedání dlaždic
HU Lapemelő
RO Presa pt. etrier
FR Léve panneaux
IT Sollevatore delle piastrelle
ES Levantador de baldosas
CN 瓷砖抬高器

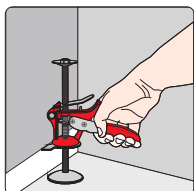

YATO	
YT-37200	10/60

EN Painting bucket
PL Wiadro malarskie
DE Malereimer
RU Ведро малярное
CZ Vědro malířské
HU Festővödör
RO Găleată pt. vopsea
FR Seau à peinture
IT Secchio per vernice
ES Cubo para pintar
CN 油漆桶



YATO	V [l]	
YT-54741	8	10
YT-54742	12	10
YT-54743	15	10
YT-54744	19	10

EN Dust protection door type "L"
PL Osłona przeciwpylowa - drzwi foliowe typu "L"
DE Folien-Staubschutztür, L-Form
RU Пылезащитная пленка - пленочная дверь типа "L"
CZ Protiprachový kryt - fóliové dveře typu "L"
HU Porvédelem - "L" típusú fóliaajtó
RO Ușă de protecție împotriva prafului tip "L"
FR Pare-poussière - porte en plastique de type "L"
IT Protezione antipolvere - porta in pellicola tipo "L"
ES Puerta de protección antipolvo tipo "L"
CN 塑料装修防尘门

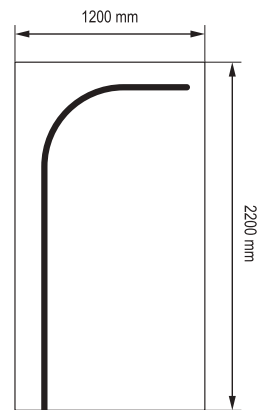
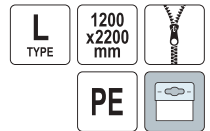

YATO	Size / Rozmiar [mm]	
YT-67221	1200x2200	12

EN Transport roller dolly
PL Wózek, platforma transportowa
DE Transportplattform
RU Транспортная тележка
CZ Přepravní plošina
HU Szállító platform
RO Platforma cu roti pt. transport
FR Chariot à plateforme
IT Carrello a piattaforma
ES Carro de transporte
CN 木板搬家器



YATO	Platform size / Rozmiar platformy [mm]	
YT-37420	500x300	6

EN Transport roller dolly
 PL Wózek, platforma transportowa
 DE Transportplattform
 RU Транспортная тележка
 CZ Přepravní plošina
 HU Szállító platform
 RO Platforma cu roti pt. transport
 FR Chariot à plateforme
 IT Carrello a piattaforma
 ES Carro de transporte
 CN 木板搬家器

575x300 mm max 200 kg PLYWOOD SKLEJKA



YATO	Platform size / Rozmiar platformy [mm]	
YT-37421	575x300	6

EN Trolley for transporting large plate
 PL Wózek do transportu dużych płyt
 DE Plattenkarre zum Transport von großflächigen Platten
 RU Тележка для перевозки больших плит
 CZ Vozík pro přepravu velkých panelů
 HU Lapszállító kocsi
 RO Cărucior pt. transportul plăcii mari
 FR Chariot porte plaque et panneau
 IT Carrello porta lastre
 ES Carro manual de transporte para planchas
 CN 移木板车

∅125mm



YATO	
YT-37433	6

EN Wallboard carrier
 PL Uchwyt do noszenia płyt gipsowo-kartonowych
 DE Plattenträger mit Tragegriff
 RU Приспособление для переноски плит
 CZ Držák pro přenášení desek s rukojetí
 HU Jellemzők és előnyök
 RO Dispozitiv pt. transportat plac de gips-carton
 FR Porte-plaques a griffes
 IT Impugnatura porta lastre in cartongesso
 ES Empunadura porta-placas
 CN 石膏板提取器

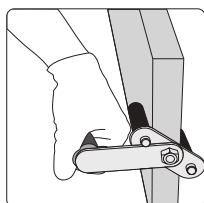

YATO	
YT-37440	2/12

EN Drywall tool cart
 PL Wózek do transportu płyt gipsowo-kartonowych
 DE Transportwagen für Gipskartonplatten
 RU Тележка для транспортировки гипсокартона
 CZ Vozík pro přepravu sádro-kartonových desek
 HU Gipszkarton szállító kézikocsi
 RO Cărucior pt. transport plăci gips carton
 FR Chariot pour le transport des plaques de carton-plâtre
 IT Carrello per trasporto pannelli GK
 ES Carro de transporte de placas cartón yeso
 CN 面板运输工具车

1240x640 x1210 mm max 900 kg ∅203mm 1x BRAKE HAMULEC



YATO	Dimensions / Wymiary [mm]	
YT-37430	1240x640x1210	1

EN Drywall tool cart
 PL Wózek do transportu płyt gipsowo-kartonowych
 DE Transportwagen für Gipskartonplatten
 RU Тележка для транспортировки гипсокартона
 CZ Vozík pro přepravu sádro-kartonových desek
 HU Gipszkarton szállító kézikocsi
 RO Cărucior pt. transport plăci gips carton
 FR Chariot pour le transport des plaques de carton-plâtre
 IT Carrello per trasporto pannelli GK
 ES Carro de transporte de placas cartón yeso
 CN 面板运输工具车

600x90 x1000 mm max 200 kg 830 230 mm ∅260mm



YATO	Dimensions / Wymiary [mm]	
YT-37434	600x90x1000	1

EN Panel carrier
 PL Uchwyt do noszenia płyt i desek
 DE Tragegriff für Platten und Bretter
 RU Ручка для переноски плит и досок
 CZ Rukojeť pro přenášení panelů a desek
 HU Fogantyú lemezék és deszkák hordozásához
 RO Dispozitiv carat plăci
 FR Porte plaques et panneaux
 IT Maniglia per il trasporto pannelli e tavole
 ES Soporte para llevar paneles y tableros
 CN 石膏板提手

max 24mm



YATO	
YT-37441	20

EN Panel carry
PL Nosidło do płyt gipsowo-kartonowych
DE Plattenträger mit Tragegriff
RU Приспособление для переноски плит
CZ Držák pro přenášení desek s rukojetí
HU Gipszkarton hordó
RO Dispositiv pt. transportat plac de gips-carton
FR Poignée transport de plaque
IT Porta lastre in cartongesso
ES Porta-paneles
CN 石膏板提手



max **80 kg**

ABS



YATO	Max. lifting capacity / Maks. udźwig [kg]	
YT-37444	80	12

EN Edge planing machine for gypsum plate
PL Strug do krawędzi płyt gipsowo-kartonowych
DE Gipskarton-Kantenhobel
RU Рубанок кромочный для гипскартона
CZ Hoblík na hrany sádrokartonu
HU Gipszkartonos élygalyu
RO Dispozitiv tăiat gips carton
FR Placoplâtre raboteuse
IT Piaalla per bordi per lastre in cartongesso
ES Cepillo biselador carton yeso
CN 塑料刨边器

9.5-15 mm

x2
BLADES
OSTRZA



YATO	
YT-76260	10/60

EN Drywall stripper
PL Obcinak dwustronny do płyt gipsowo-kartonowych
DE Streifenschneider
RU Рейсмус-резак для гипскартона
CZ Řezák na sádrokarton
HU Gipszkarton vágó
RO Dispozitiv reglabil de taiere a placilor de gips-carton
FR Outil coupe cloison sèche
IT Taglierina reversibile per cartongesso
ES Cortador de tiras para tablaroca
CN 石膏板切割器

2x
Ø 38 mm

DOUBLE-SIDED DWU-STRONNY

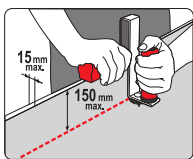

YATO	
YT-76266	6/12

EN Drywall stripper
PL Obcinak dwustronny do płyt gipsowo-kartonowych
DE Streifenschneider
RU Рейсмус-резак для гипскартона
CZ Řezák na sádrokarton
HU Gipszkarton vágó
RO Dispozitiv reglabil de taiere a placilor de gips-carton
FR Outil coupe cloison sèche
IT Taglierina reversibile per cartongesso
ES Cortador de tiras para tablaroca
CN 石膏板切割器

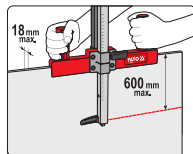

DOUBLE-SIDED DWU-STRONNY

x10



YATO	
YT-76270	1

EN Drywall board lifter
PL Aluminiowa dźwignia do unoszenia płyt gipsowo-kartonowych
DE Alu-Plattenheber für Gipskartonplatten
RU Педаль подъемная для гипскартона
CZ Páka pro zdvihacie plošiny
HU Gipszkarton emelő
RO Elevator de picior
FR Levier à panneau
IT Sollevatore in alluminio per lastre
ES Levanta paneles
CN 石膏板起板器

55 mm

Al



YATO	
YT-37450	10

EN 2 knives for planer set
PL Noże do struga do płyt gipsowo-kartonowych
DE Klengen für Gipskartonhobel
RU Ножи для рубанка для гипскартона
CZ Nože do hoblíku do sádro-kartonových desek
HU Penge gipszkarton gyaluhoz

RO Set 2 cutite rindea
FR Lame pour cutter de carton plâtre
IT Lame per piaalla per pannelli di cartongesso
ES Cuchillas para cepillo de placas cartón-yeso
CN 刀片

2
PCS



For YT-76260
Dla YT-76260

YATO	
YT-76261	75/300

EN Drywall stripper
PL Obcinak dwustronny do płyt gipsowo-kartonowych
DE Streifenschneider
RU Рейсмус-резак для гипскартона
CZ Řezák na sádrokarton
HU Gipszkarton vágó
RO Dispozitiv reglabil de taiere a placilor de gips-carton
FR Outil coupe cloison sèche
IT Taglierina reversibile per cartongesso
ES Cortador de tiras para tablaroca
CN 石膏板切割器

DOUBLE-SIDED DWU-STRONNY

x10

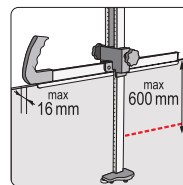

YATO	
YT-76280	6

EN Telescopic support bar
 PL Podpora teleskopowa
 DE Baustütze-Schnellspannstütze
 RU Подъемник-распорка для гипсокартона
 CZ Tyč teleskopická rozpěrná
 HU Teleszkópos támasztórúd
 RO Suport sustinere telescopic
 FR Presse extensible
 IT Supporto telescopico
 ES Puntal expansion
 CN 伸缩顶杆



YATO
YT-64551



EN Telescopic support bar
 PL Podpora teleskopowa
 DE Baustütze-Schnellspannstütze
 RU Подъемник-распорка для гипсокартона
 CZ Tyč teleskopická rozpěrná
 HU Teleszkópos támasztórúd
 RO Suport sustinere telescopic
 FR Presse extensible
 IT Supporto telescopico
 ES Puntal expansion
 CN 伸缩顶杆



YATO
YT-64552



EN Mini folding scaffold
 PL Rusztowanie składane
 DE Klappgerüst
 RU Складные леса
 CZ Skládací lešení
 HU Összecsukható állvány
 RO Mini scheleă pliabilă
 FR Échafaudage pliant
 IT Ponteggio pieghevole
 ES Andamio plegable
 CN 迷你脚手架

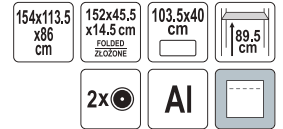

YATO
YT-30610



EN Work platform
 PL Podest roboczy
 DE Arbeitsplattform
 RU Рабочая платформа
 CZ Pracovní plošina
 HU Munkaállvány
 RO Platforma de lucru
 FR Plate-forme de travail
 IT Pedana da lavoro
 ES Plataforma de trabajo
 CN 洗车台



YATO
YT-30600



EN Straight pliers
 PL Kleszcze do gięcia blach
 DE Zange zum Blechbiegen

RU Клеши с тупым ножом для жести
 CZ Kleště na ohýbání plechu
 HU Falcfogó

RO Cleste pt. indoirea tablei
 FR Pince à fléchir la tôle
 IT Taglie per la lamiera

ES Tenazas para doblar hojalata
 CN 钣金钳

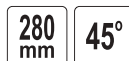

YATO
YT-5416

L [mm]
280



YATO
YT-5417

L [mm]
260



YATO
YT-5415

L [mm]
280



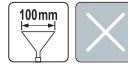

EN Straight pliers
PL Kleszce do gięcia blach
DE Zange zum Blechbiegen
RU Клещи с тупым ножом для жести
CZ Kleště na ohýbání plechu
HU Falcfogó
RO Cleste pt. indoarea tablei
FR Pince à fléchir la tôle
IT Taglie per la lamiera
ES Tenazas para doblar hojalata
CN 钣金钳

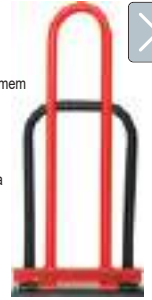

EN Single seam clencher
PL Zaciskacz rąbka pojedynczego
DE Klemmvorrichtung für einfachen Falz
RU Зажим одинарного фальца
CZ Svorka pro drážkování s jednoduchým lemem
HU Korczáró fogó
RO Clema pt. falt simplu
FR Pince à joint debout simple
IT Pinza per aggraffatura singola
ES Pinza de primer pliegue para junta alzada
CN 屋顶施工工具



YATO 	L [mm]	
YT-54153	300	6

YATO 	Pipe diameter / Średnica rurki [mm]	Size / Rozmiar [mm]	
YT-5400	18	480x220	5

EN Double seam clencher
PL Zaciskacz rąbka podwójnego
DE Klemmvorrichtung für doppelten Falz
RU Зажим двойного фальца
CZ Svorka pro drážkování s dvojitým lemem
HU Dupla korczáró fogó
RO Clema pt. falt dublu
FR Pince à double joint debout
IT Pinza per aggraffatura doppia
ES Pinza de segundo pliegue para junta alzada
CN 屋顶施工工具

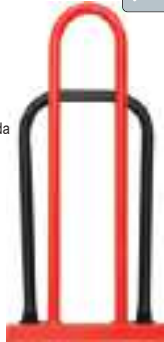





EN Eaves turner
PL Kantownik okapu
DE Traufenkanter
RU Кромкогиб для карнизной планки
CZ Ohýbač hran okapu
HU Ereszperemező fogó
RO Cornier streasina
FR Plieuse à larmier
IT Piegatrice per gronda
ES Pinza para doblar bandeja
CN 屋顶施工工具

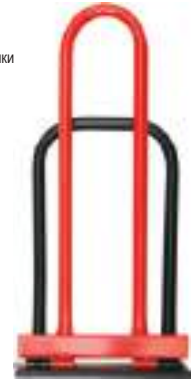



EN Eaves clencher
PL Zaciskacz okapu
DE Traufenklemme
RU Зажим для карнизной планки
CZ Ohýbač hran okapu
HU Ereszszáró fogó
RO Clema pt. streasina
FR Pince à larmier
IT Pinza chiusura gronda
ES Pinza para alero
CN 屋顶施工工具





YATO 	Pipe diameter / Średnica rurki [mm]	Size / Rozmiar [mm]	
YT-5402	18	480x220	5

YATO 	Pipe diameter / Średnica rurki [mm]	Size / Rozmiar [mm]	
YT-5404	18	450x200	5

YATO 	Pipe diameter / Średnica rurki [mm]	Size / Rozmiar [mm]	
YT-5405	18	450x200	5

EN Metal panel hemming tool
PL Zaginadlo ręczne parapetowe
DE Falzwerkzeug für Metallplatten
RU Ручной изгиб
CZ Nástroj na lemování parapetu
HU Kézi korczáró szerszám
RO Instrument de tivire a panourilor metalice
FR Outil pour plier les appuis de fenêtre
IT Utensile per piegare pannelli di metallo
ES Dobladora manual de vierteaguas metálicos
CN 金属板折边器





YATO 	Working width / Szerokość robocza [mm]	L [mm]	
YT-54090	250	230	10

EN Drainpipe hooks bender
PL Zaginacz haków rynnowych
DE Biegevorrichtung für Rinnenhaken
RU Инструмент для загиба крюков желобов
CZ Ohýbač okapových háků
HU Ereszszatornavas hajlító

RO Dispozitiv pt. indoit carlige burlan
FR Pince à crochets de gouttières
IT Piegaferrì per sostegni grondaia
ES Pinza para soportes de canalón
CN 弯管器



YATO 	L [mm]	
YT-5410	680	4

EN Drainpipe hooks bender
PL Zaginacz haków rynnowych
DE Biegevorrichtung für Rinnenhaken
RU Инструмент для загиба крюков желобов
CZ Ohýbač okapových háků
HU Ereszszatornavas hajlító
RO Dispozitiv pt. indoit carlige burlan
FR Pince à crochets de gouttières
IT Piegaferrì per sostegni grondaia
ES Pinza para soportes de canalón
CN 弯管器



YATO 	L [mm]	
YT-54101	630	4

EN Pipe crimper
PL Szczytce do karbowania rur
DE Rohreinziehzange mit 5 Klingen
RU Ножницы по металлу для гофры
CZ Kleště kreovací
HU Krepplő kullancsok
RO Cleste gofrare burlane
FR Pince à gaufrer 5 lames
IT Pinza per corrugare tubi
ES Crimpadora de tubos
CN 波浪剪

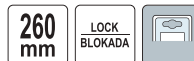

YATO 	L [mm]	
YT-22380	260	6/36

EN Wire tying twister hook
PL Klucz do wiązania drutu zbrojeniowego
DE Rödeldraht-Drillkurbel
RU Крючок для вязки арматуры
CZ Radlovačka
HU Huzalsodró
RO Dispozitiv pt. legat fier beton
FR Lieur
IT Gancio per legare armature
ES Gancho para amarrar alambre
CN 钢筋钩

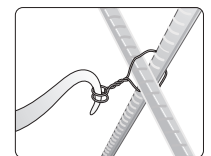

YATO 	L [mm]	
YT-54230	210	50/100

EN Automatic twister hook for wire tying
 PL Klucz automatyczny do skręcania drutu
 DE Röheldraht-Drillkurbel
 RU Автоматический крюк для вязки арматуры
 CZ Spirálový vazač
 HU Huzalsodró készülék
 RO Dispozitiv automat pt. legat fier beton
 FR Lieur automatique
 IT Torcilo lo automatico
 ES Gancho para amarrar alambre automatico
 CN 自动伸缩钢筋钩



YATO	L [mm]	
YT-54233	300	10/30

EN Paving slab lifter
 PL Chwytnak do płyt chodnikowych
 DE Greifer für Steinplatten
 RU Захват для тротуарной плитки
 CZ Uchopovač dlažebních desky
 HU Járdólap fogó
 RO Dispozitiv ridicat placi
 FR Léve-dalle réglable
 IT Maniglia per trasporto piastrelle
 ES Pinzas para transportar losas
 CN 提砖器



EN Brick tongs
 PL Chwytnak do podnoszenia płyt lub cegieł
 DE Greifer zum Heben von Platten oder Ziegeln
 RU Захват для подъема плит или кирпича
 CZ Nástroj pro přenášení desek a cihel
 HU Csempe- és téglafogó
 RO Cieste caramida
 FR Pince de levage pour dalles et briques
 IT Pinza per sollevamento lastre o mattoni
 ES Pinzas para transportar placas o ladrillos
 CN 砖夹



YATO	Grip range / Zakres chwytu [mm]	
YT-37470	400-670	12

YATO	Grip range / Zakres chwytu [mm]	
YT-46500	300-500	5/15
YT-46501	400-600	5/15

EN Rectangular floating rule
 PL Łata murarska
 DE Setzlatte 2 Libellen
 RU Правило-уровень
 CZ Lat' zednická s libelami
 HU Ólesléc, téglalap keresztmetszetű
 RO Dreptar cu 2 bule
 FR Niveau à bulle
 IT Livella
 ES Nivel de albañil
 CN 刮板



YATO	L [mm]	
YT-3071	1500	10
YT-3072	2000	10
YT-3073	2500	10
YT-3074	3000	10

YATO	L [mm]	
YT-3076	1500	10
YT-3077	2000	10
YT-3078	2500	10
YT-3079	3000	10

EN Trapezoid floating rule
 PL Łata tynkarska
 DE Abziehlatte mit Trapezprofil
 RU Правило трапециевидное
 CZ Lat' malířská
 HU Ólesléc, trapézoid keresztmetszetű
 RO Dreptar trapezoidal
 FR Niveau à bulle
 IT Livella trapezoidale
 ES Nivel de albañil
 CN 梯形刮板



EN Toothed comb with variable length
 PL Łata zębata z regulowaną długością
 DE Längenverstellbare Zahnlatte
 RU Зубчатая рейка с регулируемой длиной
 CZ Zubatá lata s nastavitelnou délkou
 HU Állítható hosszúságú fogas léc
 RO Pieptene dintat cu lungime variabilă
 FR Latte dentée réglable en longueur
 IT Livellatrice a cazzuola dentata con lunghezza regolabile
 ES Llana dentada con longitud ajustable
 CN 瓷砖平灰器

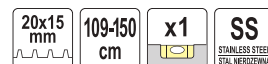

YATO	L [mm]	
YT-3081	1500	10
YT-3082	2000	10
YT-3083	2500	10
YT-3084	3000	10

YATO	L [mm]	
YT-30700	1090-1500	10

EN Knife for roofing paper
 PL Nóż do cięcia papy
 DE Messer zum Schneiden von Pappe
 RU Нож для резки рубероида
 CZ Nůž k řezání lepenky
 HU Kátránpapírvágó olló
 RO Cutter pt. tăierea cartonului asfaltat
 FR Couteau pour carton
 IT Coltello per tagliare cartone bituminoso
 ES Cuchilla para cortar cartón alquitranado
 CN 多功能刀



YATO	L [mm]	
YT-7620	230	12/60

EN Knife for mineral wool
 PL Nóż do cięcia izolacji budowlanych
 DE Messer zum Schneiden von Bauisolierungen
 RU Нож для резки строительной изоляции
 CZ Nůž k řezání stavebních izolačních hmot
 HU Kés épületszigetelés vágásához
 RO Cutter pt. tăierea izolațiilor
 FR Couteau pour isolants
 IT Coltello per tagliare l'isolamento di costruzione
 ES Cuchilla para cortar aislamiento de construcción
 CN 多功能刀



350/500 mm	
------------	--

YATO	L [mm]	
YT-7623	500	10/50

335/480 mm	
------------	--

YATO	L [mm]	
YT-7624	480	10/50

EN Electric hoist
PL Elektryczny wciągnik linowy
DE Elektro-Seilwinde
RU Электрическая канатная лебёдка
HU Elektromos csőrő
RO Troliu electric cu cablu
FR Treuil électrique à corde
IT Verricello elettrico
ES Cabría eléctrica de cuerdas
CN 电动葫芦

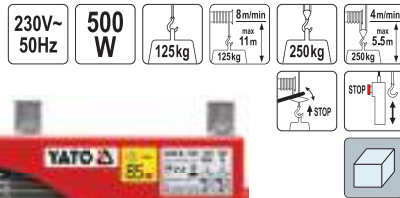

$L_{pa} = 52,2 \pm 1,2$ dB; $L_{wa} = 73,6 \pm 2,31$ dB

YATO 	[W]	
YT-5901	500	2

EN Electric hoist
PL Elektryczny wciągnik linowy
DE Elektro-Seilwinde
RU Электрическая канатная лебёдка
HU Elektromos csőrő
RO Troliu electric cu cablu
FR Treuil électrique à corde
IT Verricello elettrico
ES Cabría eléctrica de cuerdas
CN 电动葫芦

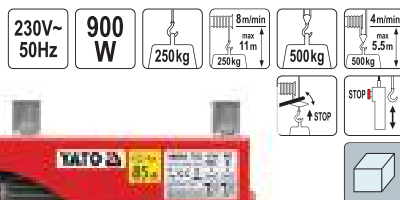

$L_{pa} = 54,0 \pm 0,9$ dB; $L_{wa} = 78,0 \pm 6,57$ dB



YATO 	[W]	
YT-5904	900	2

EN Mixer
PL Mieszadło
DE Rührer
RU Мешалка
CZ Michadlo
HU Keverő

RO Mixer
FR Mélangeur
IT Mescolatore
ES Mezclador
CN 搅拌机



• Application: powder materials, general-purpose adhesives, gypsum surface finishing mixes, epoxy grouts
• Zastosowanie: materiały sypkie, gotowe zaprawy klejowe, masy szpachlowe, zaprawy do spoinowania



YATO 	Ø [mm]	L [mm]	Toolholder type / Rodzaj uchwytu narzędziowego	Max. mixing capacity / Maks. wydajność mieszania [kg]	
YT-5490	85	410	sześciorzędny	4-9	30
YT-5491	100	600	sześciorzędny	6-16	16
YT-5492	85	450	SDS-Plus	4-9	30
YT-5493	100	600	SDS-Plus	6-16	16

EN Mixer
PL Mieszadło
DE Rührer
RU Мешалка
CZ Michadlo
HU Keverő

RO Mixer
FR Mélangeur
IT Mescolatore
ES Mezclador
CN 搅拌机



• Application: emulsion paints, acrylic paints, lacquers, stains, other liquid materials
• Zastosowanie: farby emulsyjne, farby akrylowe, lakiery, bejce, inne materiały płynne

YATO 	Ø [mm]	L [mm]	Toolholder type / Rodzaj uchwytu narzędziowego	Max. mixing capacity / Maks. wydajność mieszania [kg]	
YT-5494	80	400	sześciorzędny	5-10	30
YT-5496	100	600	SDS-Plus	15-30	20

EN Electric hoist
PL Elektryczny wciągnik linowy
DE Elektro-Seilwinde
RU Электрическая канатная лебёдка
HU Elektromos csőrő
RO Troliu electric cu cablu
FR Treuil électrique à corde
IT Verricello elettrico
ES Cabría eléctrica de cuerdas
CN 电动葫芦

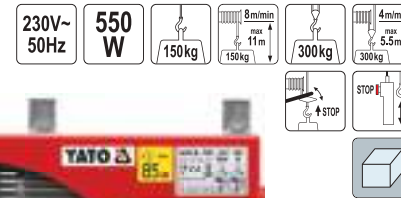

$L_{pa} = 52,2 \pm 0,9$ dB; $L_{wa} = 75,4 \pm 4,8$ dB

YATO 	[W]	
YT-5902	550	2

EN Electric hoist
PL Elektryczny wciągnik linowy
DE Elektro-Seilwinde
RU Электрическая канатная лебёдка
HU Elektromos csőrő
RO Troliu electric cu cablu
FR Treuil électrique à corde
IT Verricello elettrico
ES Cabría eléctrica de cuerdas
CN 电动葫芦

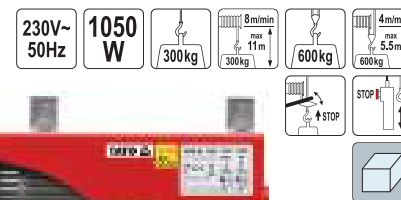

$L_{pa} = 58,9 \pm 1,9$ dB; $L_{wa} = 79,9 \pm 2,79$ dB



YATO 	[W]	
YT-5905	1050	2



EN Mixer
PL Mieszadło
DE Rührer
RU Мешалка
CZ Michadlo
HU Keverő

RO Mixer
FR Mélangeur
IT Mescolatore
ES Mezclador
CN 搅拌机



• Application: powder materials, general-purpose adhesives, gypsum surface finishing mixes, epoxy grouts
• Zastosowanie: materiały sypkie, gotowe zaprawy klejowe, masy szpachlowe, zaprawy do spoinowania

YATO 	Ø [mm]	L [mm]	Toolholder type / Rodzaj uchwytu narzędziowego	Max. mixing capacity / Maks. wydajność mieszania [kg]	
YT-54895	60	320	sześciorzędny	4-9	30

YATO 	Ø [mm]	L [mm]	Toolholder type / Rodzaj uchwytu narzędziowego	Max. mixing capacity / Maks. wydajność mieszania [kg]	
YT-5494	80	400	sześciorzędny	5-10	30
YT-5496	100	600	SDS-Plus	15-30	20

EN Mixer
PL Mieszadło
DE Rührer
RU Мешанка
CZ Michadlo
HU Keverő

RO Mixer
FR Mélangeur
IT Mescolatore
ES Mezclador
CN 搅拌器



• Application: general-purpose adhesives, masonry mortars, jointless floors, thin-layer mineral plasters, gypsum surface finishing mixes, isolation masses

• Zastosowanie: zaprawy klejowe, zaprawy murarskie, jastrychy, tynki strukturalne, masy szpachlowe, masy izolacyjne

YATO	Ø [mm]	L [mm]	Toolholder type / Rodzaj uchwytu narzędziowego	Max. mixing capacity / Maks. wydajność mieszania [kg]	
YT-5497	70	400	sześciokątny	5-10	20
YT-5499	100	600	sześciokątny	10-20	16
YT-5500	120	600	sześciokątny	15-25	14
YT-5501	100	600	SDS-Plus	10-20	16
YT-5502	120	600	SDS-Plus	15-25	14
YT-5503	120	600	M14	15-25	14
YT-5504	160	600	M14	20-30	8

EN Mixer
PL Mieszadło
DE Rührer
RU Мешанка
CZ Michadlo
HU Keverő

RO Mixer
FR Mélangeur
IT Mescolatore
ES Mezclador
CN 搅拌器



• Application: mortars, concrete, plasters, other semi-fluid materials with sand or gravel filling

• Zastosowanie: zaprawy, beton, tynki, inne półpłynne, lepkie materiały z wypełnieniem piaskowym lub żwirowym

YATO	Ø [mm]	L [mm]	Max. mixing capacity / Maks. wydajność mieszania [kg]	Toolholder type / Rodzaj uchwytu narzędziowego	
YT-5506	120	600	15-25	SDS-Plus	12
YT-5507	120	600	15-25	M14	12
YT-5508	160	600	20-30	M14	8

EN Suction lifter
PL Uchwyt-przyssawka do szyb
DE Glas-Gummissauger
RU Держатель-присоска для стекол
CZ Podtlakový držák na sklo
HU Szélvédő kiemelő
HU Szélvédő kiemelő
RO Ventuza
FR Ventouse simple pour pare-brise
IT Ventosa per vetro
ES Elevador tipo ventosa
CN 手泵式吸盘



YATO	Ø [mm]	Max. lifting capacity / Maks. udźwąg [kg]	
YT-37220	204	58	10

EN Suction lifter
PL Uchwyt-przyssawka do szyb
DE Glas-Gummissauger
RU Держатель-присоска для стекол
CZ Podtlakový držák na sklo
HU Szélvédő kiemelő
HU Szélvédő kiemelő
RO Ventuza
FR Ventouse simple pour pare-brise
IT Ventosa per vetro
ES Elevador tipo ventosa
CN 手泵式吸盘

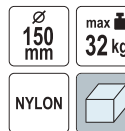

YATO	Ø [mm]	Max. lifting capacity / Maks. udźwąg [kg]	
YT-37223	150	32	24

EN Suction lifter
PL Uchwyt-przyssawka do szyb
DE Glas-Gummissauger
RU Держатель-присоска для стекол
CZ Podtlakový držák na sklo
HU Szélvédő kiemelő
HU Szélvédő kiemelő
RO Ventuza
FR Ventouse simple pour pare-brise
IT Ventosa per vetro
ES Elevador tipo ventosa
CN 手泵式吸盘



YATO	Ø [mm]	Max. lifting capacity / Maks. udźwąg [kg]	
YT-37235	125	60	30

EN Suction lifter
PL Uchwyt-przysawka do szyb
DE Glas-Gummissauger
RU Держатель-присоска для стекол двойная
CZ Podtlakový držák na sklo
HU Szélvédő kiemelő
RO Ventuze
FR Ventouse double pour pare-brise
IT Ventosa per vetro
ES Elevador tipo ventosa
CN 手泵式吸盘



Ø 125 mm
max 120 kg
AI

YATO	Ø [mm]	Max. lifting capacity / Maks. udźwig [kg]	
YT-37236	125	120	20

EN Suction lifter
PL Uchwyt-przysawka do szyb
DE Glas-Gummissauger
RU Держатель-присоска для стекол тройная
CZ Podtlakový držák na sklo
HU Szélvédő kiemelő
RO Ventuze
FR Ventouse triple pour pare-brise
IT Ventosa per vetro
ES Elevador tipo ventosa
CN 手泵式吸盘



Ø 125 mm
max 190 kg
AI

YATO	Ø [mm]	Max. lifting capacity / Maks. udźwig [kg]	
YT-37237	125	190	12

EN Angle suction holder
PL Uchwyt-przysawka do szyb kątowa
DE Verstellbarer Winkelsauger für Glas
RU Угловая присоска для стекла
CZ Úhlová přísavka na sklo
HU Derékszögű üvegfogó tappancs
RO Ventuze pt. colt
FR Ventouse articulée double pour vitre
IT Ventosa ad angolo per vetro
ES Elevador tipo ventosa angular
CN 角度吸盘



Ø 118 mm
90-270°
max 50 kg
AI

YATO	Ø [mm]	Max. lifting capacity / Maks. udźwig [kg]	
YT-37214	118	50	10

EN Adjustable suction cups
PL Przysawki pozycjonujące
DE Stellbarer Saugheber
RU Присоска для стягивания швов двухчашечная
CZ Polohovací přísavka
HU Állítható tapadókorong
RO Ventuza reglabila
FR Ventouse de manutention
IT Ventosa regolabile di allineamento
ES Ventosa de vacío ajustable
CN 瓷砖拼缝吸盘



Ø 150 mm
440 mm

YATO	Ø [mm]	L [mm]	
YT-37210	150	440	6

EN Carpenter's pencil
PL Ołówek stolarski
DE Zimmermannsbleistifte
RU Карандаш столярный
CZ Tesařská tužka
HU Asztalos ceruza

RO Creion de tâmplărie
FR Crayon menuisier
IT Matita per falegnami
ES Lapiz de carpintero
CN 木工铅笔

HB



YATO	L [mm]	W [mm]	
YT-692501	245	15	144/1152

EN Carpenter's pencil set
PL Zestaw ołówek stolarskich
DE Bleistiftset für Zimmerleute
RU Набор столярных карандашей
CZ Sada tesařských tužek
HU Asztalos ceruzakészlet

RO Set creioane dulgherie
FR Jeu de crayons de charpentier
IT Set di matite da carpentiere
ES Juego de lapices de carpintero
CN 木工铅笔

HB



YATO	L [mm]	W [mm]	pcs / szt.	
YT-692603	175	12	3	480
YT-692612	175	12	12	120

EN Carpenters pencils red / blue
PL Ołówki techniczne czerwony/niebieski
DE Duo-Marker Bleistift rot / blau

RU Карандаши красный / синий
CZ Zásuvka červená / modrá tužka
HU Fiók ceruza piros / kék

RO Creion bicolor, rosu / albastru
FR Crayon bicolore rouge / bleu
IT Matite tecniche rosso / blu



EN Carpenter's pencil
PL Ołówek stolarski
DE Zimmermannsbleistifte
RU Карандаш столярный
HU Asztalos ceruza

RO Creion de tâmplărie
FR Crayon menuisier
IT Matita per falegnami
ES Lapiz de carpintero
CN 木工铅笔

144 PCS
HB



YATO	L [mm]	W [mm]	pcs / szt.	
YT-6925	245	15	144	8



YATO	L [mm]	W [mm]	pcs / szt.	
YT-6926	245	12	144	8

EN Masonry pencil
PL Ołówek murarski
DE Maurerbleistift
RU Карандаш каменщика
CZ Tužka zednická
HU Kőműves keverő

RO Creion
FR Crayon maçon
IT Matita per muratori
ES Lapiz de albañil
CN 木工铅笔

144 PCS
H4



YATO	L [mm]	W [mm]	pcs / szt.	
YT-6927	245	12	144	8

ES Cajón lapiz rojo / azul
CN 木工铅笔

12 PCS
175 mm
2x4 mm



YATO				
YT-69940				120

EN Automatic carpenters / masonry pencil
 PL Ołówek stolarski / murarski automatyczny
 DE Tischler- und Maurer-Druckstift
 RU Автоматический столярный карандаш / карандаш каменщика

CZ Stolářská / zednická tužka automatická
 HU Asztalos / kőműves töltőceruza
 RO Creion de tâmplărie / zidărie mecanic
 FR Crayon menuisier / maçon automatique

IT Matita per falegnami e carpentieri
 ES Lápiz automático de carpintero / albanil
 CN 自动木工铅笔

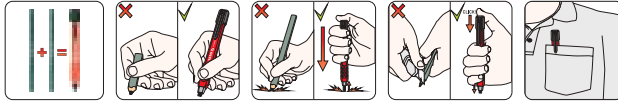

EN Automatic carpenters / masonry pencil with spare leads
 PL Ołówek stolarski / murarski automatyczny + dodatkowe grafity
 DE Tischler- und Maurer-Druckstift + zusätzliche Bleistiftmine
 RU Автоматический столярный карандаш / карандаш каменщика + дополнительный графит
 CZ Stolářská / zednická tužka automatická + náhradní tuha
 HU Asztalos / kőműves töltőceruza + tartalék grafit
 RO Creion de tâmplărie / zidărie mecanic + grafit adițional
 FR Crayon menuisier / maçon automatique
 IT Matita per falegnami e carpentieri ricaricabile
 ES Lápiz automático de carpintero / albanil + mina adicional
 CN 自动木工铅笔组套



YATO **YT-69281** PCS 24 144

EN Lead HB
 PL Grafit HB
 DE Bleistiftmine HB
 RU Графит HB
 CZ Tuha HB
 HU Grafit HB

RO Grafit HB
 FR Mine HB
 IT Grafite HB
 ES Mina HB
 CN 自动木工铅笔笔芯



For YT-69280, YT-69281
 Dla YT-69280, YT-69281

YATO **YT-69285** 20/1000

EN Lead HB
 PL Grafit HB
 DE Bleistiftmine HB
 RU Графит HB

CZ Tuha HB
 HU Grafit HB
 RO Grafit HB
 FR Mine HB



For YT-69280, YT-69281
 Dla YT-69280, YT-69281

YATO **YT-69287** 20/1000

EN Chalk set
 PL Kreda techniczna
 DE Signierkreide
 RU Мелок для рисования

CZ Barevná křída
 HU Színes kréta
 RO Creta colorata
 FR Craie pour le dessin

IT Gesso tecnico
 ES Tiza para dibujar
 CN 记号蜡笔



YATO **YT-69930** 50



YATO **YT-69931** 50

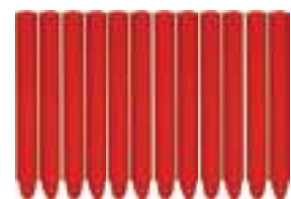

YATO **YT-69932** 50

YATO **YT-69280** 50/500

EN Deep hole pencil with leads
 PL Ołówek do głębokich otworów z rysikami
 DE Tieflochmarker mit Ersatzminen
 RU Карандаш для глубоких отверстий со сменными стержнями
 CZ Tužka do hlubokých otvorů s náhradními náplněmi
 HU Mélylyuk jelölő hegyekkel
 RO Creion automat cu mina
 FR Crayon à trous profonds avec recharge
 IT Matita per fori profondi con marcatori
 ES Lápiz para orificios profundos con puntas de trazar
 CN 木工铅笔

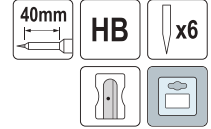

YATO **YT-69290** 10/100

EN Lead H2
 PL Grafit H2
 DE Bleistiftmine H2
 CZ Tuha H2
 HU Grafit H2

RO Grafit H2
 FR Mine H2
 IT Grafite H2
 ES Mina H2
 CN 自动木工铅笔笔芯

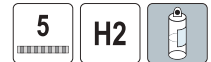

For YT-69280, YT-69281
 Dla YT-69280, YT-69281

YATO **YT-69286** 20/1000

EN Pencil leads set
 PL Zestaw rysików
 DE Griffel-Set
 RU Набор стилусов
 CZ Sada stylusů
 HU Tartalék hegy szett grafit
 RO Set mine creion
 FR Jeu de recharges
 IT Set di mine di ricarica
 ES Juego de puntas para lápices
 CN 铅笔芯

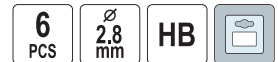

For YT-69290
 Dla YT-69290

YATO **YT-69291** 20/200

Memo

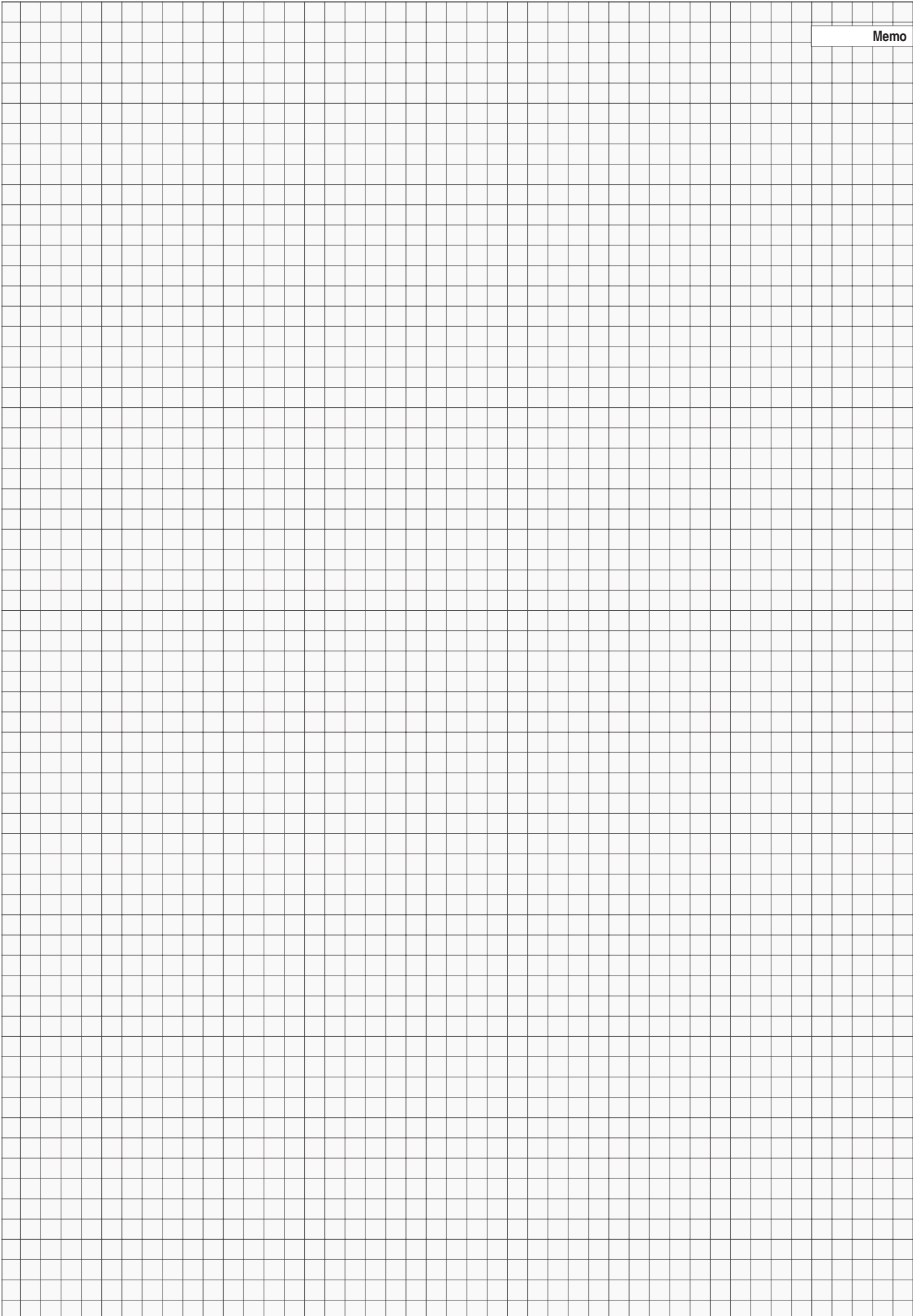

14

Measuring tools Narzędzia miernicze



Hygrometers
Higrometry

302 

Electronic measuring tools
Elektroniczne urządzenia pomiarowe

307-310 

Measuring tapes
Miary zwijane

302-303 

Leveling patches
Łaty niwelacyjne

310 

Rulers
Przymiary

303-304 

Levels
Poziomnice

311-312 

Steel set squares
Ekierki metalowe

304 

Feelers
Szczelinomierze

313 

Try squares
Kątowniki stolarskie

304-306 

Dividers & calipers
Cyrkle i macki

313 

Vernier calipers
Suwmiarki

306-307 

Protractors
Kątomierze

314 

Micrometers
Mikrometry

307 

Screw pitch gauges
Sprawdziany grzebieniowe do gwintów

314 

EN Hygrometer
 PL Higrometr
 DE Hygrometer
 RU Гигрометр
 CZ Hygrometr
 HU Higrométer
 RO Higrometru
 FR Hygrometre
 IT Igrometro
 ES Higrómetro
 CN 湿度测试仪



6-42% 0.2-2.0%
 max 7 mm LCD
 AUTO POWER OFF AUTOMATYCZNE WYŁĄCZANIE

EN Hygrometer
 PL Higrometr
 DE Hygrometer
 RU Гигрометр
 CZ Hygrometr
 HU Higrométer



6-60% 0.2-2.9%
 max 10 mm LCD
 AUTO POWER OFF AUTOMATYCZNE WYŁĄCZANIE



YATO

YT-73140

54/108

YATO

YT-73141

20/40

EN Measuring tape
 PL Miara zwijana
 DE Rollbandmass
 RU Рулетка
 CZ Měřicí pásmo
 HU Mérőszalag
 RO Rulete din pinza
 FR Ruban à mesurer
 IT Misura di nastro
 ES Flexómetro
 CN 卷尺

3m 5m AUTOMATIC STOP
 16mm 19mm
 NYLON COATED POWŁOKA NYLONOWA
 II



EN Measuring tape
 PL Miara zwijana
 DE Rollbandmass
 RU Рулетка
 CZ Měřicí pásmo
 HU Mérőszalag
 RO Rulete din pinza
 FR Ruban à mesurer
 IT Misura di nastro
 ES Flexómetro
 CN 卷尺

3m 5m 8m
 16mm 25mm 25mm
 AUTOMATIC STOP
 NYLON COATED POWŁOKA NYLONOWA
 II



EN Measuring tape
 PL Miara zwijana
 DE Rollbandmass
 RU Рулетка
 CZ Měřicí pásmo
 HU Mérőszalag
 RO Rulete din pinza
 FR Ruban à mesurer
 IT Misura di nastro
 ES Flexómetro
 CN 卷尺

3m 5m 8m
 16mm 19mm 25mm
 NYLON COATED POWŁOKA NYLONOWA
 II



YATO	L [m]	W [mm]	
YT-7103	3	16	12/120
YT-7105	5	19	12/120

YATO	L [m]	W [mm]	
YT-7110	3	16	12/120
YT-7111	5	25	12/60
YT-7112	8	25	6/60

YATO	L [m]	W [mm]	
YT-7126	3	16	12/120
YT-7127	5	19	12/120
YT-7128	8	25	6/60

EN Measuring tape
 PL Miara zwijana
 DE Rollbandmass
 RU Рулетка
 CZ Měřicí pásmo
 HU Mérőszalag
 RO Rulete din pinza
 FR Ruban à mesurer
 IT Misura di nastro
 ES Flexómetro
 CN 卷尺

3m 5m 8m
 16mm 19mm 25mm
 NYLON COATED POWŁOKA NYLONOWA
 II



EN Measuring tape
 PL Miara zwijana
 DE Rollbandmass
 RU Мирная лента
 CZ Měřicí pásmo
 HU Mérőszalag
 RO Rulete din pinza
 FR Metre ruban
 IT Misura di nastro
 ES Flexómetro
 CN 卷尺

3m 5m 5m
 16mm 19mm 25mm
 8m 25mm
 NYLON COATED POWŁOKA NYLONOWA
 II



EN Measuring tape
 PL Miara zwijana
 DE Rollbandmass
 RU Мирная лента
 CZ Měřicí pásmo
 HU Mérőszalag
 RO Rulete din pinza
 FR Metre ruban
 IT Misura di nastro
 ES Flexómetro
 CN 卷尺

3m 5m 8m
 16mm 19mm 25mm
 NYLON COATED POWŁOKA NYLONOWA
 II



YATO	L [m]	W [mm]	
YT-7129	3	16	12/120
YT-7130	5	19	12/120
YT-7131	8	25	6/60

YATO	L [m]	W [mm]	
YT-71070	3	16	12/120
YT-71071	5	19	12/96
YT-71072	5	25	12/72
YT-71073	8	25	6/48

YATO	L [m]	W [mm]	
YT-71075	3	16	12/120
YT-71076	5	19	12/96
YT-71077	8	25	6/48

EN Measuring tape
PL Miara zwijana
DE Rollbandmass
RU Мярная лента
CZ Měřicí pásmo
HU Mérőszalag
RO Rulete din pinza
FR Metre ruban
IT Misura di nastro
ES Flexómetro
CN 卷尺

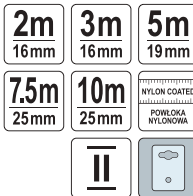

YATO	L [m]	W [mm]	
YT-71150	2	16	12/120
YT-71151	3	16	12/120
YT-71153	5	19	12/96
YT-71155	7.5	25	6/48
YT-71156	10	25	6/36

EN Steel measuring tape
PL Taśma miernicza stalowa
DE Rollbandmass
RU Мярная лента стальная
CZ Měřicí pásmo ocelové
HU Acél mérőszalag
RO Ruleta sticla
FR Ruban à mesurer acier
IT Misura di nastro a acciaio
ES Cinta de medir de acero
CN 钢卷尺



YATO	L [m]	W [mm]	
YT-71580	20	13	10/40
YT-71581	30	13	10/40
YT-71582	50	13	5/20

EN Fibreglass measuring tape
PL Taśma miernicza z włókna szklanego
DE Rollbandmass
RU Мярная лента фибргласс
CZ Měřicí pásmo - skleněné vlákno
HU Mérőszalag - üvegszál
RO Ruleta fibra sticla
FR Ruban à mesurer fibre-verre
IT Misura di nastro in fibra di vetro
ES Cinta de medir - fibra cristal
CN 纤维卷尺

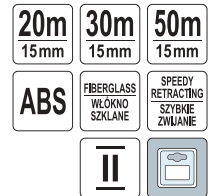

YATO	L [m]	W [mm]	
YT-71570	20	15	10/40
YT-71571	30	15	10/40
YT-71572	50	15	5/20

EN Fibreglass measuring tape
PL Taśma miernicza z włókna szklanego
DE Rollbandmass
RU Мярная лента фибргласс
CZ Měřicí pásmo - skleněné vlákno
HU Mérőszalag - üvegszál
RO Ruleta fibra sticla
FR Ruban à mesurer fibre-verre
IT Misura di nastro in fibra di vetro
ES Cinta de medir - fibra cristal
CN 纤维卷尺

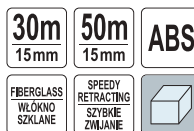

YATO	L [m]	W [mm]	
YT-71540	30	15	10
YT-71541	50	15	10

EN Diameter and circumference measuring tape
PL Taśma stalowa do pomiaru średnicy i obwodu
DE Umfang Bandmass
RU Циркометр для измерения длины окружности и диаметра
CZ Cirkometry-měřicí pásky pro obvod a průměr
HU Circometer szalagos mérés
RO Banda pt. masurat circumferinta
FR Ruban à mesurer circomètre
IT Metro a nastro in acciaio per misurare diametri e circonferenze
ES Circometer cinta métrica
CN 圆周尺

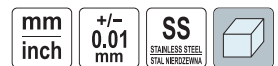

YATO	Ø [mm]	Circumference / Obwód [mm]	
YT-71700	20-300	60-950	50
YT-71701	300-700	940-2200	50
YT-71702	700-1100	2190-3460	50

EN Stainless steel flexible ruler
PL Przymiar stalowy elastyczny
DE Metrisches Gerade Lineal Inox
RU Линейка гибкие, нержавеющая сталь
CZ Měřitko z nerezové pružinové oceli
HU Acél vonalzó

RO Rigle masura inox
FR Règlet métallique en inox
IT Righello flessibile in acciaio
ES Regla flexible acero inox
CN 钢直尺



YATO	L [mm]	
YT-70720	150	10/500
YT-70721	300	12/300
YT-70722	500	20/120
YT-70723	600	20/120
YT-70724	1000	20/60

EN Aluminium ruler
PL Przymiar aluminiowy
DE Alu Zeichen-Massstab
RU Линейка алюминиевая
CZ Měřicí lat hliníková
HU Asztalos vonalzó, alumínium

RO Riglă tâmplar din aluminiu
FR Règle aluminium
IT Righello di alluminio
ES Regla de aluminio
CN 铝合金直尺



YATO	L [mm]	
YT-7070	300	25/100
YT-7071	600	10/50

EN Safety cutting ruler
 PL Linijka do bezpiecznego cięcia
 DE Sicherheits-Schneidelineal
 RU Линейка для безопасной резки
 CZ Bezpečnostní řezací pravítko
 HU Biztonsági vágó vonalzó

RO Riglă de tăiere în siguranță
 FR Règle pour couper en sécurité
 IT Righello da taglio
 ES Regla para corte seguro
 CN 防护尺



YATO	L [mm]	
YT-70725	200	20/200
YT-70726	300	20/120
YT-70727	450	10/80

EN Steel set square
 PL Ekiarka metalowa
 DE Anschlagwinkeldreieck
 RU Угольник для плотника и столяра
 CZ Úhelník
 HU Fém derékszög
 RO Echer tamplarie
 FR Équerre de menuisier
 IT Squadra metallica
 ES Escuadra metálica
 CN 铝合金三角尺



YATO	L [mm]	
YT-70780	170	6/72
YT-70781	270	6/36

EN Aluminium alloy triangle
 PL Kątownik ciesielski do krokwi
 DE Anschlagwinkeldreieck
 RU Угольник для плотника и столяра
 CZ Úhelník na meranie
 HU Fém derékszög
 RO Echer aluminiu pt. dulgherie
 FR Équerre triangle règle
 IT Squadra da carpentiere
 ES Escuadra metálica
 CN 铝合金三角尺

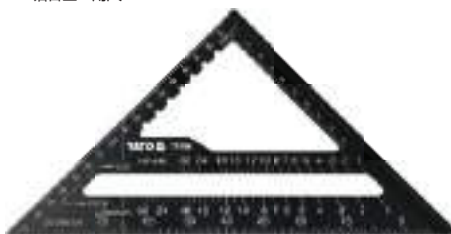

YATO	L [mm]	
YT-70786	180	8/64
YT-70787	300	6/24

EN Extension layout tool
 PL Kątownik aluminiowy ze stopką - ekiarka
 DE Aluminium-Quadrat mit Fuß - Metall-Winkelmaß - Winkelmesser
 RU Алюминиевый угольник с основанием - металлический угольник - угольник
 CZ Hliníkový úhelník s patkou - kovový úhelník - úhleník
 HU Talpas alumínium derékszög - fém vonalzó - derékszög
 RO Dispozitiv pt. talai la profil
 FR Cornière en aluminium avec pied - équerre en métal - rapporteur
 IT Squadra in alluminio con piede - squadra da disegno metallica - squadra
 ES Escuadra de aluminio con pie, metálica
 CN 铝合金三角尺



YATO	Dimensions / Wymiary [mm]	
YT-70783	165x185x210-290	6/24

EN Folding builder's square
 PL Kątownik budowlany składany
 DE Bauwinkel Klappbar
 RU Угольник складной строительный
 CZ Skládací stavební úhelník
 HU Összecsukható derékszög
 RO Echer pliant din aluminiu
 FR Équerre pliante
 IT Squadra da muratore pieghevole
 ES Escuadra plegable construcción
 CN 折叠铝合金角尺

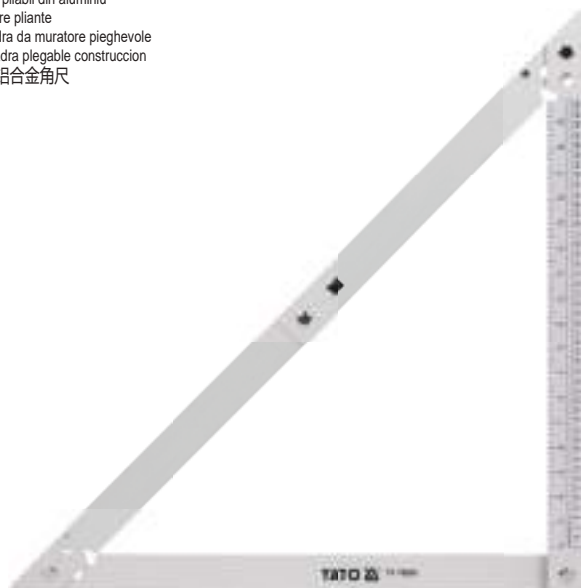

YATO	Dimensions / Wymiary [mm]	
YT-70850	840x600x600	6/24
YT-70851	1720x1220x1220	10

EN Aluminium ruler
 PL Przymiar aluminiowy
 DE Alu Zeichen-Massstab
 RU Линейка столярная алюминиевая
 CZ Meracia latta hliníková
 HU Riglă tâmplar din aluminiu

RO Aszталos vonalzó, alumínium
 FR Règle aluminium
 IT Righello di alluminio
 ES Regla de aluminio
 CN 铝合金直尺



YATO	L [mm]	
YT-70713	500	8/32
YT-70715	1000	8/32

EN Adjustable quick square
 PL Ekiarka metalowa - kątownik
 DE Metall-Dreieck - Winkelmesser
 RU Металлический угольник
 CZ Kovový úhelník
 HU Fém vonalzó - derékszög
 RO Echer reglabil
 FR Équerre de charpentier avec rapporteur d'angle
 IT Squadra da disegno metallica
 ES Escuadra metálica
 CN 金属三角三角板



YATO	Dimensions / Wymiary [mm]	
YT-70782	175x175x275	6/24

EN Aluminium try square
PL Kątownik do płyt gipsowo-kartonowych
DE Anschlagwinkel
RU Угольник столлярный
CZ Truhlářský úhelník černý
HU Asztalos derékszög, fekete

RO Echer de tâmplărie negru
FR Équerre
IT Squadra per pannelli in gesso
ES Escuadra de aluminio
CN 角尺



YATO	L [mm]	
YT-7085	1200	10

EN Try square
PL Kątownik stalowy
DE Anschlagwinkel
RU Угольник столлярный
CZ Truhlářský úhelník
HU Asztalos derékszög
RO Echer de tâmplărie
FR Équerre
IT Angolo di acciaio
ES Escuadra
CN 不锈钢角尺



YATO	Size / Rozmiar [mm]	
YT-7083	150x300	25/100
YT-7084	250x500	10/50

EN Combination square
PL Kątownik ślusarski nierdzewny
DE Edelstahl-Schlosserwinkel
RU Угольник слесарный
CZ Zámečnický úhelník nerezový
HU Rozsdamentes lakatos derékszög
RO Echer combinat
FR Équerre de serrurier en acier inoxydable
IT Squadra per fabbro in acciaio inox
ES Escuadra de cerrajero inoxidable
CN 角尺



YATO	L [mm]	
YT-70843	150	6/48

EN Aluminium try square
PL Kątownik aluminiowy
DE Alu-Zimmermannswinkel
RU Угольник столлярный алюминиевый
CZ Truhlářský úhelník černý
HU Asztalos derékszög
RO Echer (unghi drept) de tâmplărie
FR Règle d'angle
IT Angolo di alluminio
ES Escuadra de aluminio
CN T型尺



YATO	Size / Rozmiar [mm]	
YT-70791	600x360	6/24
YT-70792	1220x560	6/12

EN Aluminium try square
PL Kątownik aluminiowy
DE Anschlagwinkel
RU Угольник столлярный
CZ Truhlářský úhelník
HU Asztalos derékszög
RO Echer de tâmplărie
FR Équerre en aluminium
IT Angolo di alluminio
ES Escuadra de aluminio
CN 铝合金角尺



YATO	L [mm]	
YT-7080	250	6/36
YT-7081	300	6/36
YT-7082	350	6/36

EN Carpentry square set
PL Zestaw kątowników stolarskich
DE Tischlerwinkelsatz
RU Набор столлярных уголков
CZ Sada tesafských úhelníků
HU Asztalos derékszög készlet
RO Set echere tamplarie
FR Jeu d'équerres de menuiserie
IT Set di squadre da carpentiere
ES Conjunto de escuadras de carpintero
CN 木工角尺

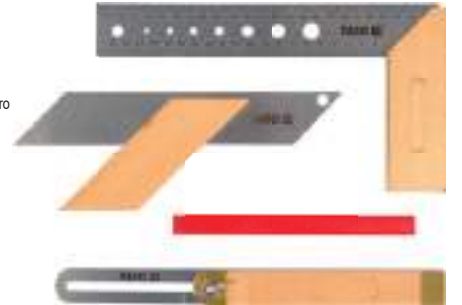

YATO	L [mm]	
YT-70823	180, 235, 250, 250	4/40

EN Adjustable ruler
PL Kątownik nastawny do przenoszenia wymiarów
DE Multifunktionales Messlineal
RU Разметочный инструмент линейка-шаблон
CZ Pokosník nastavitelný
HU Szögmérőtékek
RO Echer reglabil
FR Angle mesure
IT Squadra regolabile tracciatore
ES Medición del ángulo
CN 铝合金四折尺



YATO	Size / Rozmiar [mm]	
YT-70880	250x120	10/50

EN Adjustable angle square
PL Kątownik nastawny
DE Einstellbarer Winkel
RU Регулируемый угольник
CZ Nastavitelný úhloměr
HU Állítható asztalos derékszög
RO Echer reglabil
FR Règle d'angle réglable
IT Squadra regolabile
ES Escuadra ajustable
CN 可调整角度尺

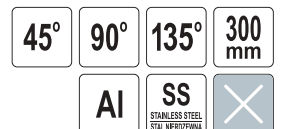

YATO	L [mm]	
YT-70794	300 (listwa), 160 (stopka)	60

EN Multi-purpose bevel
 PL Kątownik wielofunkcyjny
 DE Mehrzweck-Winkelhalter
 RU Многофункциональный угольник
 CZ Multifunkční úhelník
 HU Multifunkciós derékszög
 RO Vinclu multifunctional cu nivea
 FR Règle d'angle multifonction
 IT Squadra multifunzionale
 ES Escuadra multifunción
 CN 组合角尺

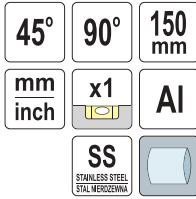

YATO L [mm]
 YT-70770 150 12/72

EN Multi-purpose bevel
 PL Kątownik wielofunkcyjny
 DE Mehrzweck-Winkelhalter
 RU Многофункциональный угольник
 CZ Multifunkční úhelník
 HU Multifunkciós derékszög
 RO Vinclu multifunctional cu nivea
 FR Règle d'angle multifonction
 IT Squadra multifunzionale
 ES Escuadra multifunción
 CN 组合角尺

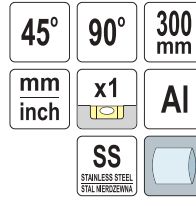

YATO L [mm]
 YT-70771 300 12/72

EN Multi-purpose bevel with protract
 PL Kątownik wielofunkcyjny centrujący
 DE Zentrier-Mehrzweck-Winkelhalter
 RU Многофункциональный центрирующий угольник
 CZ Multifunkční centrovací úhelník
 HU Multifunkciós központosító derékszög
 RO Vinclu multifunctional cu nivea
 FR Règle de centrage multifonctionnel
 IT Squadra multifunzionale centrante
 ES Escuadra multifunción de centraje
 CN 组合角尺

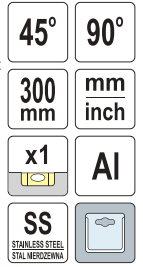

YATO L [mm]
 YT-70772 300 12/36

EN 3D aluminium mitre square
 PL Kątownik aluminiowy 3D
 DE Winkel mit Gehrung
 RU Угольник алюминиевый 3D
 CZ Japonský 3D úhelník
 HU Alu derékszög 3D
 RO Echer pt. imbinari
 FR Japonais en alliage d'aluminium bois règle
 IT Squadra in alluminio 3D
 ES Japonés regla de aluminio cuadrado diseño
 CN 划线尺

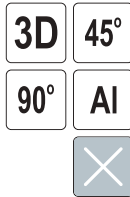

YATO
 YT-70797 25/100

EN 3D aluminium mitre square
 PL Kątownik przestrzenny
 DE Raum-Winkelstahl
 RU Пространственный угольник
 CZ Posuvný úhelník
 HU 3D vonalzó
 RO Echer aluminiu 3D
 FR Équerre japonaise
 IT Squadra tridimensionale
 ES Escuadra tridimensional
 CN 木工角尺

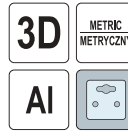

YATO Dimensions / Wymiary [mm]
 YT-70825 150x70x215 10/50

EN 3D aluminium mitre square
 PL Kątownik aluminiowy 3D
 DE Winkel mit Gehrung
 RU Угольник алюминиевый 3D
 CZ Japonský 3D úhelník
 HU Alu derékszög 3D
 RO Echer pt. imbinari
 FR Japonais en alliage d'aluminium bois règle
 IT Squadra in alluminio 3D
 ES Japonés regla de aluminio cuadrado diseño
 CN 铝合金划线尺

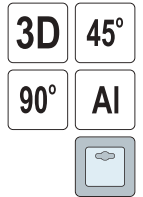

YATO
 YT-70796 10/100

EN Vernier caliper
 PL Suwmiarka
 DE Messschieber
 RU Штангенциркуль
 CZ Posuvné měřítko
 HU Tolóméró

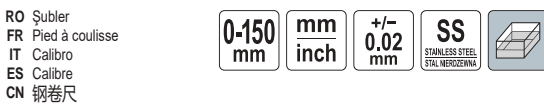

YATO Measuring range / Zakres pomiaru [mm]
 YT-7200 0-150 50

EN Digital caliper
 PL Suwmiarka elektroniczna
 DE Digital Messschieber
 RU Штангенциркуль электронный
 CZ Posuvné měřítko elektronické
 HU Digitális tolóméró

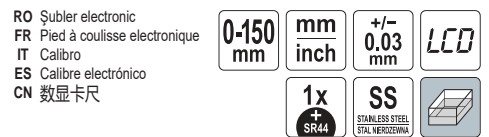

YATO Measuring range / Zakres pomiaru [mm]
 YT-7201 0-150 10/50

EN Vernier caliper
 PL Suwmiarka
 DE Messschieber
 RU Штангенциркуль
 CZ Posuvné měřítko
 HU Tolóméró

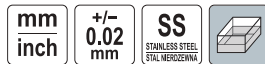

YATO Measuring range / Zakres pomiaru [mm]
 YT-72003 0-200 30
 YT-72004 0-300 20

EN Vernier caliper
 PL Suwmiarka
 DE Messschieber
 RU Штангенциркуль
 CZ Posuvné měřítko
 HU Tolóméró



YATO Measuring range / Zakres pomiaru [mm]
 YT-70740 0-600 12/24

EN Disc brake vernier caliper
PL Suwmiarka do tarcz hamulcowych
DE Scheibenbremse noniusschieber
RU Штангенциркуль для тормозных листов
CZ Digitální posuvné měřítko na brzdové kotouče
HU Tárcsafék tolómérő
RO Subler pt. masurat discuri de frana cu display digital
FR Disque de frein etrier vernier
IT Calibro a corsoio per dischi del freno
ES Freno de disco pie de rey
CN 制动片卡尺

160 mm 0-60 mm +/- 0.01 mm SS STAINLESS STEEL STAL NIERZCZENA



YATO	Measuring range / Zakres pomiaru [mm]	
YT-72090	0-60	50

EN Micrometer CZ Mikrometr IT Micrometro
PL Mikrometr HU Mikrométer ES Micrómetro
DE Mikrometer RO Micrometru CN 外径千分尺
RU Микрометр FR Micromètre

+/- 0.01 mm



YATO	Measuring range / Zakres pomiaru [mm]	
YT-72300	0-25	100
YT-72301	25-50	50
YT-72302	50-75	50
YT-72303	75-100	30

EN Laser distance meter with tape measure and cross laser line
PL Dalmierz laserowy z miarą związaną i laserem krzyżowym
DE Laser-Entfernungsmesser mit Maßband und Kreuzlaser
RU Лазерный дальномер с рулеткой и перекрестными лучами
CZ Laserový dálkoměr s měřicí páskou a křížovým laserem
HU Lézeres távolságmérő mérőszalaggal és keresztlézerrel
RO Telemetru laser, cu ruleta
FR Télémètre laser avec ruban à mesurer et laser croisé
IT Tracciatore laser con metro a rullo e laser a raggio incrociato
ES Telémetro láser con cinta métrica y láser cruzado
CN 激光卷尺测距仪



3 in 1 3 w 1 5m 19mm II 0.2-40m +/-2mm
90° CLASS / KLASA MEMORY PAMIĘĆ LCD
ABS 2x AAA



EN Laser distance meter
PL Dalmierz laserowy
DE Laserentfernungsmesser
RU Лазерный дальномер
CZ Laserový měřič vzdálenosti
HU Lézeres távolságmérő
RO Telemetru cu laser
FR Télémètre laser
IT Misuratore di distanza laser
ES Medidores láser de distancias
CN 激光测距仪

40m 0.2-40m +/-2mm
x20 MEMORY PAMIĘĆ
x10 MODES TRYBY CONSTANT ANGLE PITCH MEASUREMENT CIĄGŁY POMIAR KĄTA NACHYLENIA
IP65 USB TYPE C

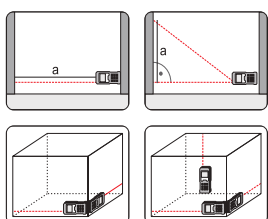

YATO	Measuring range / Zakres pomiaru [mm]	
YT-73126		20

EN Disc brake digital caliper
PL Suwmiarka elektroniczna do tarcz hamulcowych
DE Digitalen Scheibenbremse
RU Штангенциркуль электронный для тормозных листов
CZ Elektronické posuvné měřítko na brzdové kotouče
HU Elektronikus tárcsafék tolómérő
RO Subler pt. masurat discuri de frana cu display digital
FR Disque de frein etrier électronique
IT Calibro a corsoio elettronico per dischi del freno
ES Pie de rey digital para discos de freno
CN 制动片卡尺

mm inch 180 mm 0-70 mm +/- 0.03 mm 55mm
LCD SS STAINLESS STEEL STAL NIERZCZENA 1x CR2032



YATO	Measuring range / Zakres pomiaru [mm]	
YT-72093	0-70	50

EN Micrometer with a digital display
PL Mikrometr z wyświetlaczem cyfrowym
DE Mikrometer mit Digitalanzeige
RU Микрометр с цифровым индикатором
CZ Mikrometr s digitálním displejem
HU Mikrométer digitális kijelzővel
RO Micrometru cu afişaj digital
FR Micromètre
IT Micrometro con digitale elettronico
ES Micrómetro con pantalla digital
CN 数显外径千分尺

mm inch 0-25 mm +/- 0.001 mm LCD



YATO	Measuring range / Zakres pomiaru [mm]	
YT-72305	0-25	50

YATO	Measuring range / Zakres pomiaru [mm]	
YT-73122		20

EN Laser distance meter
PL Dalmierz laserowy
DE Laserentfernungsmesser
RU Лазерный дальномер
CZ Laserový měřič vzdálenosti
HU Lézeres távolságmérő
RO Telemetru cu laser
FR Télémètre laser
IT Misuratore di distanza laser
ES Medidores láser de distancias
CN 激光测距仪

60m 0.2-60m +/-2mm
x20 MEMORY PAMIĘĆ
x10 MODES TRYBY CONSTANT ANGLE PITCH MEASUREMENT CIĄGŁY POMIAR KĄTA NACHYLENIA
IP65 USB TYPE C
3x AAA

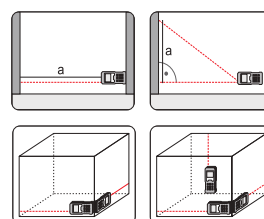

YATO	Measuring range / Zakres pomiaru [mm]	
YT-73127		20

- EN Laser distance meter
- PL Dalmierz laserowy
- DE Laserentfernungsmesser
- RU Лазерный дальномер
- CZ Laserový měřič vzdálenosti
- HU Lézeres távolságmérő
- RO Telemetru cu laser
- FR Télémètre laser
- IT Telemetro laser
- ES Medidores láser de distancias
- CN 激光测距仪



5-900m ±1m	905 nm	0-300 ±5 km/h	H	II CLASS / KLASA	2x AAA II	
---------------	--------	------------------	---	---------------------	--------------	--

- EN Distance measuring wheels
- PL Kolo miernicze
- DE Messrad
- RU Колесо измерительное
- CZ Kolečko pro měření vzdálenosti
- HU Kicsi mérőkerék
- RO Roți de măsură
- FR Roues de mesure
- IT Ruota di misurazione
- ES Ruedas de medición
- CN 测距轮



0.1-9999.9 m	0.5% ACCURACY DOKŁADNOŚĆ
160 mm	38-92 cm
AI	

- EN Distance measuring wheels
- PL Kolo miernicze
- DE Messrad
- RU Колесо измерительное
- CZ Kolečko pro měření vzdálenosti
- HU Kicsi mérőkerék
- RO Roți de măsură
- FR Roues de mesure
- IT Ruota di misurazione
- ES Ruedas de medición
- CN 测距轮



m/ft	0.1-9999.9 m
0.5% ACCURACY DOKŁADNOŚĆ	160 mm
LCD	82-104 cm
AI	ABS



YATO
YT-71650

8

YATO
YT-71655

10

- EN Cross line green laser
- PL Laser krzyżowy zielony
- DE Laser mit grünem Kreuz
- RU Лазерный уровень зеленый крест
- CZ Laser zelený křížový
- HU Zöld keresztlézér
- RO Nivelă cu laser transversală
- FR Niveau laser à croix verte
- IT Livella laser verde a linee incrociate
- ES Láser en cruz verde
- CN 激光水平仪

±3.0mm /10m LASER ACCURACY DOKŁADNOŚĆ LASERA	±4° SELF-REGULATION SAMOREGULACJA	510-530 nm	1/4" (6.3 mm) TRIPOD THREAD GWINT STATYWU	°C -10 +50
≤1 mW	II CLASS / KLASA	IP54	6V	4x AA II



YATO
YT-30433

30

- EN Cross line green laser
- PL Laser krzyżowy zielony
- DE Laser mit grünem Kreuz
- RU Лазерный уровень зеленый крест
- CZ Laser zelený křížový
- HU Zöld keresztlézér
- RO Nivelă cu laser transversală
- FR Niveau laser à croix verte
- IT Livella laser verde a linee incrociate
- ES Láser en cruz verde
- CN 激光水平仪

±3.0mm /10m LASER ACCURACY DOKŁADNOŚĆ LASERA	±4° SELF-REGULATION SAMOREGULACJA	510-530 nm	3.7 V 5200mAh Li-Ion	1/4" (6.3 mm) TRIPOD THREAD GWINT STATYWU
°C -10 +50	≤1 mW	II CLASS / KLASA		



YATO
YT-30434

20

EN Line green laser
PL Laser liniowy zielony
DE Laser mit grüner Linie
RU Лазерный уровень зеленый линейный
CZ Laser zelený liniový
HU Zöld vonalézer
RO Nivelă cu laser
FR Niveau laser à ligne verte
IT Livella laser lineare verde
ES Láser línea verde
CN 投线仪



±3.0mm /10m
LASER ACCURACY
DOKŁADNOŚĆ LASERA

±4°
SELF-REGULATION
SAMOREGULACJA

510-530 nm

1/4" (6.3 mm)
TRIPOD THREAD
GWINT STĄTOWY

°C -10 +50

≤1 mW
CLASS / KLASA II

IP54

6V

4x AA



YATO
YT-30435

20

EN Line green laser 3D
PL Laser liniowy zielony 3D
DE 3D-Laser mit grüner Linie
RU Лазерный уровень зеленый линейный 3D
CZ Laser zelený liniový 3D
HU Zöld vonalézer 3D
RO Nivelă cu laser 3D
FR Niveau laser 3D à ligne verte
IT Livella laser lineare 3D verde
ES Láser 3D línea verde
CN 投线仪



±3.0mm /10m
LASER ACCURACY
DOKŁADNOŚĆ LASERA

±4°
SELF-REGULATION
SAMOREGULACJA

510-530 nm

3.7 V
5200mAh
Li-Ion

1/4" (6.3 mm)
TRIPOD THREAD
GWINT STĄTOWY

°C -10 +50

≤1 mW
CLASS / KLASA II

IP54



YATO
YT-30436

12

EN Tile laser
PL Laser glazurniczy
DE Fliesenlaser
RU Лазерный уровень для плит
CZ Laserová vodováha
HU Csempélézer
RO Nivel laser pt. plăci
FR Laser tuile
IT Livella laser per piastrelle
ES Láser de baldosas
CN 地板仪



10m

±10mm /10m

x2

ABS

2x AA

90°

YATO
YT-30410

4/16

EN Laser line marker
PL Znacznik laserowy
DE Laserführung
RU Лазерная метка
CZ Čárový laserový modul
HU Vonal lézer modul
RO Marcator de linii laser
FR Module laser linéaire
IT Modulo laser linea
ES Marcador láser
CN 激光定位器



CLASS / KLASA I

CLASS / KLASA II

CLASS / KLASA III

YATO
YT-30414

6/36

EN Red glasses for laser
PL Okulary czerwone do pracy z laserem
DE Rote Laserschutzbrille
RU Красные очки для работы с лазером
CZ Červené brýle pro práci s laserem
HU Zöld lézerszemüveg
RO Ochelari rosii pt. laser
FR Lunettes d'amélioration laser rouges
IT Occhiali rossi per raggi laser
ES Gafas para visión láser rojas
CN 眼镜



YATO
YT-30460

100

EN Green laser glasses
PL Okulary zielone do pracy z laserem
DE Grüne Laserschutzbrille
RU Зеленые очки для работы с лазером
CZ Zelené brýle pro práci s laserem
HU Zöld lézerszemüveg
RO Ochelari verzi pt. laser
FR Lunettes d'amélioration laser vert
IT Occhiali verdi per raggi laser
ES Gafas para visión láser verde
CN 激光眼镜



YATO
YT-30461

80

EN Red laser target card
PL Płytką pozycjonującą do lasera czerwonego
DE Rote Laser Zieltafel
RU Пластина для красного лазерного нивелира
CZ Čílová deska pro červený laser
HU Céltábla piros lézerhez
RO Card țintă cu laser roșu
FR Plaque de positionnement pour laser rouge
IT Piastra bersaglio rossa per laser
ES Placa de tarjeta para láser rojo
CN 激光靶



YATO
YT-30464

Dimensions / Wymiary [mm]
75x105x3.2

400

EN Green laser target card
PL Płytką pozycjonującą do lasera zielonego
DE Grüne Laser Zieltafel
RU Пластина для зеленого лазерного нивелира
CZ Čílová deska pro zelený laser
HU Céltábla zöld lézerhez
RO Card țintă laser verde
FR Plaque de positionnement pour laser vert
IT Piastra bersaglio verde per laser
ES Placa de tarjeta para láser verde
CN 激光靶



YATO
YT-30465

Dimensions / Wymiary [mm]
75x105x3.2

400

EN Aluminium tripod
 PL Statyw aluminiowy
 DE Aluminium-Stativ
 RU Алюминиевый штатив
 CZ Hliníkový stativ
 HU Alumínium állvány
 RO Trepied aluminiu
 FR Trépied en aluminium
 IT Tripode in alluminio
 ES Trípode de aluminio
 CN 三角架

1/4" 5/8"
(13mm) (15.8mm)
 TRIPOD THREAD
 GWINN-STÄTTWU



YATO	H [mm]	
YT-30471	150-280	20
YT-30473	320-750	10
YT-30475	460-1200	20
YT-30477	470-1500	20

EN Laser pole with tripod
 PL Tyczka do lasera ze statywem
 DE Laser Teleskopstange mit Stativ
 RU Штанга-штатив для лазерного уровня
 CZ Tyč se stativem pro laseru
 HU Teleszkóprúd, lézer állvány
 RO Stâlp laser cu trepied
 FR Perche de laser avec trépied
 IT Asta per laser con treppiede
 ES Barra para láser con trípode
 CN 水平仪伸缩杆

max
370
cm



YATO	H [mm]	
YT-30500	maks. 3700	4

EN Leveling patch
 PL Łata niwelacyjna teleskopowa
 DE Teleskop-Nivellierlatte
 RU Телескопическая нивелирная рейка
 CZ Teleskopová nivační latka
 HU Teleszkópos szintezőléc
 RO Dispozitiv nivelare
 FR Mire de nivellement télescopique
 IT Stadia telescopica
 ES Varilla de nivelación telescópica
 CN 塔尺



YATO	L [mm]	
YT-30491	1040-3000	12
YT-30492	1200-5000	12

EN Aluminium tripod
 PL Statyw aluminiowy
 DE Aluminium-Stativ
 RU Алюминиевый штатив
 CZ Hliníkový stativ
 HU Alumínium állvány
 RO Trepied aluminiu
 FR Trépied en aluminium
 IT Tripode in alluminio
 ES Trípode de aluminio
 CN 三角架

max
1500
mm

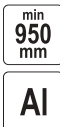

min
950
mm

1/4" 5/8"
(13mm) (15.8mm)
 TRIPOD THREAD
 GWINN-STÄTTWU



YATO	H [mm]	
YT-30479	950-1500	4

EN Laser mounting pole
 PL Tyczka do montażu lasera
 DE Laser Teleskopstange
 RU Штанга для лазерного уровня
 CZ Tyč pro montáž laseru
 HU Lézer teleszkóprúd
 RO Stâlp de montare laser
 FR Pôle de montage pour laser
 IT Asta di montaggio laser
 ES Barra para láser
 CN 水平仪伸缩杆

max
400
cm



YATO	H [mm]	
YT-30503	maks. 4000	6

EN Aluminium level
PL Poziomnica aluminiowa
DE Alu-Wasserwaage
RU Алюминиевый уровень

CZ Hliníková vodováha
HU Alumínium vízérték
RO Cumpănă de nivel aluminiu
FR Niveau à bulle aluminium

IT Livella in alluminio
ES Nivel de burbuja de aluminio
CN 铝合金水平尺



YATO	L [mm]	
YT-3001	400	20/60
YT-3002	600	20/60
YT-3003	800	10/40
YT-3004	1000	10/40
YT-3005	1200	10/20

EN Aluminium level
PL Poziomnica aluminiowa
DE Wasserwaage
RU Уровень

CZ Vodováha
HU Vízérték
RO Cumpănă
FR Niveau à bulle

IT Livella
ES Nivel
CN 铝合金水平尺



YATO	L [mm]	
YT-3022	600	10/30
YT-3023	800	10/30
YT-3024	1000	30
YT-3025	1200	20
YT-3026	1500	20



YATO	L [mm]	
YT-30071	600	10/40
YT-30072	800	10/30
YT-30073	1000	10/20
YT-30074	1200	10/20



YATO	L [mm]	
YT-30060	400	10/40
YT-30061	600	10/40
YT-30062	800	10/30
YT-30063	1000	10/20
YT-30064	1200	10/20

EN Aluminium level
PL Poziomnica aluminiowa
DE Alu-Wasserwaage
RU Алюминиевый уровень
CZ Hliníková vodováha
HU Alumínium vízérték

RO Cumpănă de nivel aluminiu
FR Niveau à bulle aluminium
IT Livella in alluminio
ES Nivel de burbuja de aluminio
CN 铝合金水平尺

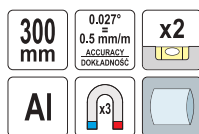

YATO	L [mm]	
YT-30310	300	40

EN Aluminium level
PL Poziomnica aluminiowa
DE Alu-Wasserwaage
RU Алюминиевый уровень
CZ Hliníková vodováha
HU Alumínium vízérték

RO Cumpănă de nivel aluminiu
FR Niveau à bulle aluminium
IT Livella in alluminio
ES Nivel de burbuja de aluminio
CN 铝合金水平尺



YATO	L [mm]	Magnet quantity / Liczba magnesów	
YT-30311	600	5	20
YT-30312	800	6	20
YT-30313	1000	7	15

EN Trapezoidal spirit level
PL Poziomnica trapezowa
DE Trapezförmige Wasserwaage
RU Трапецидальный уровень
CZ Vodováha trapezová
HU Vízérték trapéz

RO Nivela trapezoidală
FR Niveau trapèze
IT Livella trapezoidale
ES Trapezoides nivel
CN 水平尺

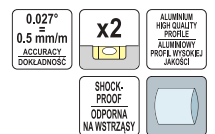

YATO	L [mm]	
YT-30370	250	60

- EN Torpedo level
- PL Poziomnica torpeda
- DE Torpedo-Wasserwaage
- RU Уровень торпедо
- CZ Vodováha torpeda
- HU Vízmérték torpedó
- RO Nivelă torpila
- FR Niveau à bulle torpédo
- IT Livella torpeda
- ES Nivel torpedo
- CN 水平尺

230 mm x3 ABS AI



YATO	L [mm]	
YT-30330	230	45

- EN Tile-setting spirit level
- PL Poziomnica glazurnicza
- DE Fliesenleger-Wasserwaage
- RU Уровень каменщика
- CZ Vodováha pro obkladače
- HU Burkolói vízmérték
- RO Nivelă cu bulă de aer
- FR Niveau à bulle pour carrelage
- IT Livella per piastrellista
- ES Nivel para azulejos
- CN 水平尺

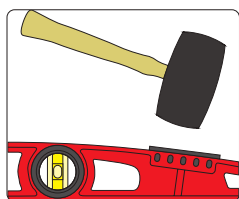

600 mm 0.027° = 0.5 mm/m ACCURACY DOKŁADNOŚĆ x2 AI SHOCK-PROOF ODPORNA NA WSTRZĄSY



YATO	L [mm]	
YT-30320	600	30

- EN Magnetic digital level
- PL Poziomnica elektroniczna magnetyczna
- DE Elektronische Magnet-Wasserwaage
- RU Электронный магнитный спиртовой уровень
- CZ Elektronická magnetická vodováha
- HU Mágneses elektromos vízmérték
- RO Nivelă digitală magnetică
- FR Niveau à bulle électronique magnétique
- IT Livella magnetica elettronica
- ES Magnético nivel electrónico
- CN 迷你数显水平尺



150 mm AI LED DISPLAY WYŚWIETLACZ

YATO	L [mm]	
YT-30395	150	30

- EN Magnetic digital level
- PL Poziomnica elektroniczna magnetyczna
- DE Elektronische Magnet-Wasserwaage
- RU Электронный магнитный спиртовой уровень
- CZ Elektronická magnetická vodováha
- HU Mágneses elektromos vízmérték
- RO Nivelă digitală magnetică
- FR Niveau à bulle électronique magnétique
- IT Livella elettronica magnetica
- ES Magnético nivel electrónico
- CN 迷你数显水平尺



400 mm x2 AI LED DISPLAY WYŚWIETLACZ

YATO	L [mm]	
YT-30397	400	30

- EN Digital laser level
- PL Poziomnica elektroniczna z laserem
- DE Elektronische Laser-Wasserwaage
- RU Электронный уровень с лазерной точкой
- CZ Elektronická vodováha s laserem
- HU Elektronikus lézeres vízmérték
- RO Nivelă cu laser electronică
- FR Niveau laser électronique
- IT Livella elettronica con laser
- ES Nivel láser electrónico
- CN 数显激光水平尺

610 mm 0.027° = 0.5 mm/m ACCURACY DOKŁADNOŚĆ x2 ±3.0mm /10m LASER ACCURACY COŁOJNOŚĆ LASERA 0-60 °C ALUMINIUM HIGH QUALITY PROFILE ALUMINIOWY PROFIL WYSOKIEJ JAKOŚCI



YATO	L [mm]	
YT-30400	610	20

EN Feeler CZ Spároměr IT Spessimetro
 PL Szczelinomierz HU Hézagmérő ES Calibre de fisuras
 DE Fühlerlehre RO Lere CN 塞尺
 RU Щупы FR Palpeur



100 mm 10 mm

x17 GAUGES LISTRI



200 mm 12.8 mm

x17 GAUGES LISTRI



YATO	L [mm]	W [mm]	± [mm]	
YT-7220	100	10	0.02, 0.03, 0.04, 0.05, 0.06, 0.07, 0.08, 0.09, 0.10, 0.15, 0.20, 0.25, 0.30, 0.40, 0.50, 0.75, 1.0	10/200

YATO	L [mm]	W [mm]	± [mm]	
YT-7221	200	12.8	0.02, 0.03, 0.04, 0.05, 0.06, 0.07, 0.08, 0.09, 0.10, 0.15, 0.20, 0.25, 0.30, 0.40, 0.50, 0.75, 1.0	10/100

100 mm 10 mm

x10 GAUGES LISTRI



200 mm 12.8 mm

x14 GAUGES LISTRI



YATO	L [mm]	W [mm]	± [mm]	
YT-7222	100	10	0.05, 0.06, 0.07, 0.08, 0.09, 0.10, 0.20, 0.30, 0.40, 0.50	10/100

YATO	L [mm]	W [mm]	± [mm]	
YT-7223	200	12.8	0.05, 0.06, 0.07, 0.08, 0.09, 0.10, 0.15, 0.20, 0.25, 0.30, 0.35, 0.40, 0.45, 0.50	10/100

EN Divider
 PL Cyrkiel z prowadnicą
 DE Bogenspitzzirkel
 RU Циркуль разметочный с подвижной дугой
 CZ Kružidlo s obloukem
 HU Ipari körző
 RO Compas de trasaj
 FR Compas traçoir
 IT Compasso con guida
 ES Compas con fijador
 CN 卡规



YATO	L [mm]	
YT-72100	150	50
YT-72101	200	50
YT-72102	300	50

EN Spring divider
 PL Cyrkiel ze sprężyną i śrubą
 DE Zirkel mit Stift
 RU Циркуль разметочный с винтом
 CZ Kružidlo s pružinou
 HU Precíziós körző
 RO Compas de trasaj cu reglaj
 FR Compas à ressort
 IT Compasso con molla e vite
 ES Compas de puntas, con muelle
 CN 弹簧卡规



YATO	L [mm]	
YT-72106	150	50
YT-72107	200	50
YT-72108	300	50

EN Outside caliper
 PL Macka zewnętrzna
 DE Greifzirkel (Außentaster)
 RU Кронциркуль для наружных измерений
 CZ Hmatadlo
 HU Külső jelölő
 RO Calibru masurat exterior
 FR Compas d'épaisseur
 IT Comparatore a bracci tastatori per esterni
 ES Compas planos para exteriores
 CN 外卡规



YATO	L [mm]	
YT-72115	200	50
YT-72116	300	50

EN Outside caliper with spring
 PL Macka zewnętrzna sprężynowa
 DE Aussenzirkel
 RU Кронциркуль для наружных измерений с винтом
 CZ Obkročňe hmatadlo se stavěcím šroubem
 HU Precíziós külső jelölő
 RO Calibru masurat exterior cu reglaj
 FR Compas à ressort d'épaisseur
 IT Comparatore a bracci tastatori per esterni a molla
 ES Compas para exteriores, con muelle
 CN 弹簧外卡规



YATO	L [mm]	
YT-72120	150	50
YT-72121	200	50
YT-72122	250	50

EN Inside caliper with spring
 PL Macka wewnętrzna sprężynowa
 DE Innenzirkel
 RU Кронциркуль-нутромер для внутренних измерений с винтом
 CZ Hmatadlo vnitorné s pružinou
 HU Precíziós jelölő körző
 RO Calibru masurat interior cu reglaj
 FR Compas à ressort d'intérieur
 IT Comparatore a bracci tastatori per interni a molla
 ES Compas para interiores, con muelle
 CN 弹簧内卡规



YATO	L [mm]	
YT-72125	150	50
YT-72126	200	25/50
YT-72127	250	100

- EN Bevel protractor
- PL Kątomierz
- DE Winkelmesser
- RU Транспортир
- CZ Protractor
- HU Szögmérő
- RO Raportor
- FR Rapporteur
- IT Rapportatore
- ES Transportador
- CN 可调量角器



10-170°
5-85°



YATO	L [mm]	
YT-70853	380	10/60

- EN Protractor
- PL Kątomierz
- DE Winkelmesser
- RU Транспортир
- CZ Protractor
- HU Szögmérő
- RO Raportor
- FR Rapporteur
- IT Rapportatore
- ES Transportador
- CN 量角器

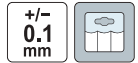

YATO	Size / Rozmiar [mm]	
YT-72140	120x150	50
YT-72141	150x200	50

- EN Digital angle ruler
- PL Kątomierz elektroniczny
- DE Digitaler Winkelmesser
- RU Электронный транспортир
- CZ Elektronický úhloměr
- HU Elektronikus szögmérő
- RO Riglă unghiulară digitală
- FR Rapporteur d'angle électronique
- IT Rapportatore elettronico
- ES Escuadra electrónica
- CN 数显角度尺

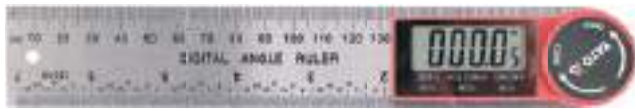
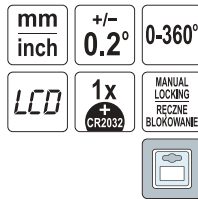

YATO	L [mm]	
YT-71003	200	10/50
YT-71004	300	10/40
YT-71005	500	5/20

- EN Screw pitch gauges
- PL Sprawdzian grzebieniowy do gwintów
- DE Gewinde-Messlehre Lehrenblätter
- RU Резьбомер
- CZ Test hřeběň
- HU Menetsablon
- RO Set lere filet
- FR Manometre pour filetage
- IT Pettine per filetti
- ES Galga para rosas
- CN 螺纹规



YATO	Thread size metric / Rozmiar gwintów metryczne [mm]	
YT-29980	0.25, 0.3, 0.35, 0.4, 0.45, 0.5, 0.6, 0.7, 0.75, 0.8, 0.9, 1, 1.25, 1.5, 1.75, 2, 2.5, 3, 3.5, 4, 4.5, 5, 5.5, 6	30/300

YATO	Thread size Whitworth / Rozmiar gwintów Whitworth	
YT-29982	4, 4.5, 5, 6, 7, 8, 9, 10, 11, 12, 13, 14, 15, 16, 18, 20, 22, 24, 25, 26, 28, 30, 32, 36, 40, 30/300	48, 60, 62

YATO	Thread size metric / Rozmiar gwintów metryczne [mm]	Thread size Whitworth / Rozmiar gwintów Whitworth	
YT-29984	0.25, 0.3, 0.35, 0.4, 0.45, 0.5, 0.6, 0.7, 0.75, 0.8, 0.9, 1, 1.25, 1.5, 1.75, 2, 2.5, 3, 3.5, 4, 4.5, 5, 5.5, 6	4, 4.5, 5, 6, 7, 8, 9, 10, 11, 12, 13, 14, 15, 16, 18, 20, 22, 24, 25, 26, 28, 30, 32, 36, 40, 48, 60, 62	20/200

Memo

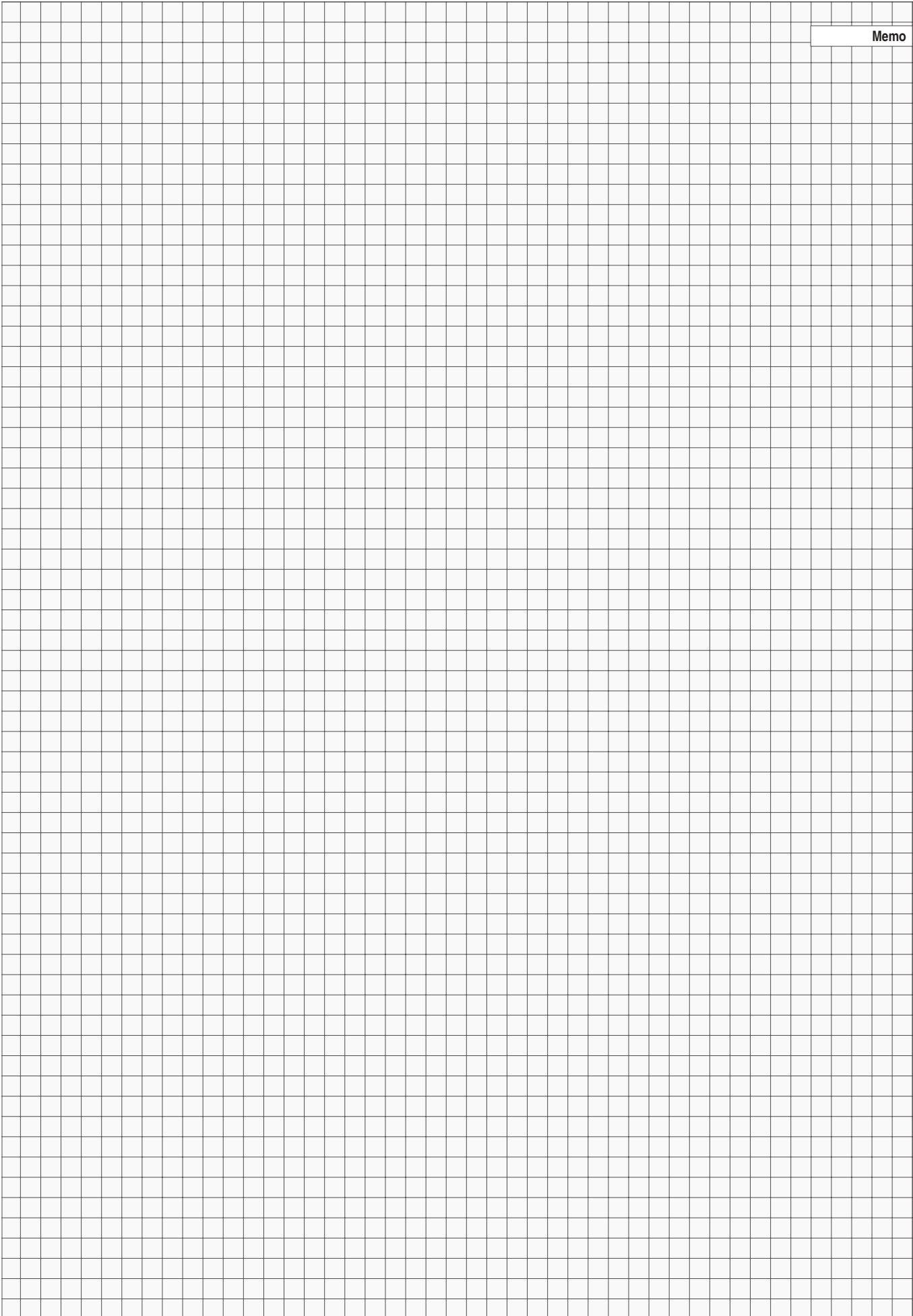

15

Pneumatic tools
Narzędzia pneumatyczne



Impact wrenches
Klucze udarowe

318-322



Pneumatic accessories

Akcesoria instalacji pneumatycznej

332-336



Impact wrenches 1/2"

Klucze udarowe 1/2"

318

Air filters, regulators & lubricators

Filtry, reduktory i smarownice

332

Impact wrenches 3/4"

Klucze udarowe 3/4"

321

Spiral hoses

Węże spiralne

333

Impact wrenches 1"

Klucze udarowe 1"

321

Reinforced hoses

Węże zbrojone

333

Couplers

Złącza

335

Other air tools

Inne narzędzia pneumatyczne

323-329



Air grease guns

Smarownice pneumatyczne

337-338



Pneumatic sets

Zestawy pneumatyczne

323

Pneumatic riveters

Nitownice pneumatyczne

339



Pneumatic ratchets & sets

Grzechotki pneumatyczne i zestawy

323

Pneumatic grinders

Szlifierki pneumatyczne

324

Pneumatic cut-off tools & discs

Przecinarki pneumatyczne i tarcze

326

Air body saws

Wyrzynarki pneumatyczne

326

Pneumatic shears

Nożyce pneumatyczne

326

Pneumatic staplers & nailers

Zszywacze i gwoździarki pneumatyczne

339-340



Pneumatic drills

Wiertarki pneumatyczne

327

Pneumatic hammers & accessories

Młotki pneumatyczne i akcesoria

327

Pneumatic staplers

Zszywacze pneumatyczne

339

Pneumatic nailers

Gwoździarki pneumatyczne

340

Inflating guns & heads

Pistolety do pompowania i głowice

328

Screws

Wkręty

340

Painting equipment & accessories

Narzędzia do malowania i akcesoria

329-332



Spray guns

Pistolety lakiernicze

329

Air vacuum cleaners

Odkurzacze pneumatyczne

330

Cleaning foam guns

Pistolety do wytwarzania piany

330

Blow guns

Pistolety do przedmuchiwania

330

Washing guns

Pistolety do ropowania

331

Sandblasting tools & accessories

Narzędzia do piaskowania i akcesoria



331

Work benches

Stojaki lakiernicze



332

EN Angle impact wrench
 PL Klucz pneumatyczny przegubowy
 DE Druckluft-Schlagschrauber mit Gelenk
 RU Ключ пневматический шарнирный
 CZ Pneumatický úhlový rázový utahovák
 HU Csuklós pneumatikus ütvecsavarozó
 RO Cheie cu impact unghiulara
 FR Clé à choc pneumatique
 IT Avvitatore pneumatico snodato
 ES Llave neumática articulada
 CN 角度衝擊扳手

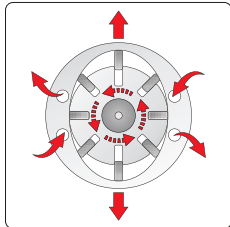
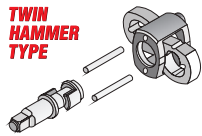

1/2" 12.7mm	TWIN HAMMER TYPE	0.63 MPa	113 l/min
500 Nm	8000 min⁻¹		



$L_{pa} = 84,8 \pm 3,0 / 90,1 \pm 3,0$ dB; $L_{wa} = 95,8 \pm 3,0 / 101,1 \pm 3,0$ dB;
 $a_n = 4,894 \pm 1,5$ m/s²



YATO 	[Nm]	
YT-09510	500	10

EN Impact wrench
 PL Klucz pneumatyczny
 DE Druckluft-Schlagschrauber
 RU Ударный пневматический гайковерт
 CZ Klúč pneumatický
 HU Pneumatikus ütvecsavarozó
 RO Pistol pneumatic
 FR Clé à choc pneumatique
 IT Chiave ad impulsi pneumatica
 ES Llave neumática de percusión
 CN 双锤式气动冲击扳手

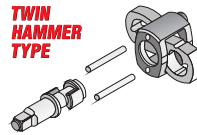

1/2" 12.7mm	TWIN HAMMER TYPE	0.63 MPa	119 l/min	550 Nm
7500 min⁻¹				



$L_{pa} = 92,0 \pm 3,0$ dB; $L_{wa} = 103,0 \pm 3,0$ dB; $a_n = 5,47 \pm 1,5$ m/s²

YATO 	[Nm]	
YT-09511	550	6

EN Impact wrench
 PL Klucz pneumatyczny
 DE Druckluft-Schlagschrauber
 RU Ударный пневматический гайковерт
 CZ Klúč pneumatický
 HU Pneumatikus ütvecsavarozó
 RO Pistol pneumatic
 FR Clé à choc pneumatique
 IT Chiave ad impulsi pneumatica
 ES Llave neumática de percusión
 CN 气动扳手

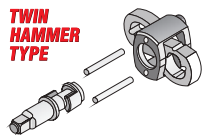

1/2" 12.7mm	TWIN HAMMER TYPE	0.63 MPa	142 l/min	570 Nm
10000 min⁻¹	COMPOSITE BODY KOMPOZYTNÝ KORPUS			



$L_{pa} = 90,7 \pm 3,0$ dB; $L_{wa} = 101,7 \pm 3,0$ dB; $a_n = 3,0 \pm 1,5$ m/s²

YATO 	[Nm]	
YT-09505	570	10

EN Impact wrench
 PL Klucz pneumatyczny
 DE Druckluft-Schlagschrauber
 RU Ударный пневматический гайковерт
 CZ Klúč pneumatický
 HU Pneumatikus ütvecsavarozó
 RO Pistol pneumatic
 FR Clé à choc pneumatique
 IT Chiave ad impulsi pneumatica
 ES Llave neumática de percusión
 CN 气动扳手

1/2" 12.7mm	SINGLE HAMMER TYPE	0.63 MPa	100 l/min	678 Nm
10000 min⁻¹				



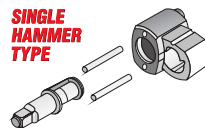

ULTRA SHORT BODY



$L_{pa} = 97,4 \pm 3,0$ dB; $L_{wa} = 103,0 \pm 3,0$ dB; $a_n = 7,3 \pm 1,21$ m/s²

YATO 	[Nm]	
YT-09512	678	10



EN Impact wrench
PL Klucz pneumatyczny
DE Druckluft-Schlagschrauber
RU Ударный пневматический гайковерт
CZ Klúč pneumatický
HU Pneumatikus ütvecsavarozó
RO Pistol pneumatic
FR Clé à choc pneumatique
IT Chiave ad impulsi pneumatica
ES Llave neumática de percusión
CN 迷你气动扳手

1/2" 12.7mm	SINGLE HAMMER TYPE	0.63 MPa	142 l/min	1200 Nm
				

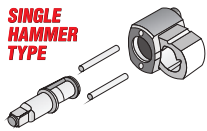
**SHORT
BODY**



$L_{pa} = 87,0 \pm 1,0$ dB; $L_{wa} = 94,0 \pm 2,0$ dB; $a_n = 9,4 \pm 0,9$ m/s²



YATO 	[Nm]	
YT-09515	1200	10

EN Impact wrench
PL Klucz pneumatyczny
DE Druckluft-Schlagschrauber
RU Ударный пневматический гайковерт
CZ Klúč pneumatický
HU Pneumatikus ütvecsavarozó
RO Pistol pneumatic
FR Clé à choc pneumatique
IT Chiave ad impulsi pneumatica
ES Llave neumática de percusión
CN 气动冲击扳手

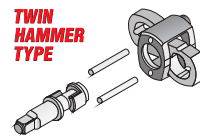

1/2" 12.7mm	TWIN HAMMER TYPE	0.63 MPa	184 l/min	680 Nm
				



$L_{pa} = 95,0 \pm 3,0$ dB; $L_{wa} = 106,0 \pm 3,0$ dB; $a_n = 9,1 \pm 1,5$ m/s²

YATO 	[Nm]	
YT-09524	680	5

EN Impact wrench
PL Klucz pneumatyczny
DE Druckluft-Schlagschrauber
RU Ударный пневматический гайковерт
CZ Klúč pneumatický
HU Pneumatikus ütvecsavarozó
RO Pistol pneumatic
FR Clé à choc pneumatique
IT Chiave ad impulsi pneumatica
ES Llave neumática de percusión
CN 气动冲击扳手

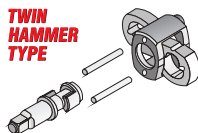

1/2" 12.7mm	TWIN HAMMER TYPE	0.6-0.8 MPa	119 l/min	850 Nm
				



$L_{pa} = 92,0 \pm 3,0$ dB; $L_{wa} = 103,0 \pm 3,0$ dB; $a_n = 5,47 \pm 1,5$ m/s²



YATO 	[Nm]	
YT-09525	850	6

EN Impact wrench
PL Klucz pneumatyczny
DE Druckluft-Schlagschrauber
RU Ударный пневматический гайковерт
CZ Klúč pneumatický
HU Pneumatikus ütvecsavarozó
RO Pistol pneumatic
FR Clé à choc pneumatique
IT Chiave ad impulsi pneumatica
ES Llave neumática de percusión
CN 气动扳手

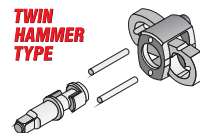

1/2" 12.7mm	TWIN HAMMER TYPE	0.63 MPa	120 l/min	1000 Nm
				



$L_{pa} = 92,0 \pm 3,0$ dB; $L_{wa} = 103,0 \pm 3,0$ dB; $a_n = 5,47 \pm 1,5$ m/s²

YATO 	[Nm]	
YT-09528	1000	6

EN Impact wrench
 PL Klucz pneumatyczny
 DE Druckluft-Schlagschrauber
 RU Ударный пневматический гайковерт
 CZ Klíč pneumatický
 HU Pneumatikus ütvecsavarozó
 RO Pistol pneumatic
 FR Clé à choc pneumatique
 IT Chiave ad impulsi pneumatica
 ES Llave neumática de percusión
 CN 气动扳手





1/2" 12.7mm	TWIN HAMMER TYPE	0.63 MPa	153 l/min	1356 Nm
				



$L_{pa} = 93,7 \pm 3,1$ dB; $L_{wa} = 104,7 \pm 3,1$ dB; $a_h = 4,4 \pm 0,4$ m/s²



YATO 	[Nm]	
YT-0953	1356	10

EN Impact wrench
 PL Klucz pneumatyczny
 DE Druckluft-Schlagschrauber
 RU Ударный пневматический гайковерт
 CZ Klíč pneumatický
 HU Pneumatikus ütvecsavarozó
 RO Pistol pneumatic
 FR Clé à choc pneumatique
 IT Chiave ad impulsi pneumatica
 ES Llave neumática de percusión
 CN 气动扳手





1/2" 12.7mm	TWIN HAMMER TYPE	0.63 MPa	153 l/min	1150 Nm
				



$L_{pa} = 93,7 \pm 3,1$ dB; $L_{wa} = 104,7 \pm 3,1$ dB; $a_h = 4,4 \pm 0,4$ m/s²



YATO 	[Nm]	
YT-09540	1150	10

EN Impact wrench
 PL Klucz pneumatyczny
 DE Druckluft-Schlagschrauber
 RU Ударный пневматический гайковерт
 CZ Klíč pneumatický
 HU Pneumatikus ütvecsavarozó
 RO Pistol pneumatic
 FR Clé à choc pneumatique
 IT Chiave ad impulsi pneumatica
 ES Llave neumática de percusión
 CN 气动扳手





1/2" 12.7mm	TWIN HAMMER TYPE	0.63 MPa	198 l/min	1700 Nm
				



$L_{pa} = 92,2 \pm 3,0$ dB; $L_{wa} = 103,2 \pm 3,0$ dB; $a_h = 4,66 \pm 1,5$ m/s²

YATO 	[Nm]	
YT-09544	1700	10

EN Impact wrench
 PL Klucz pneumatyczny
 DE Druckluft-Schlagschrauber
 RU Ударный пневматический гайковерт
 CZ Klíč pneumatický
 HU Pneumatikus ütvecsavarozó
 RO Pistol pneumatic
 FR Clé à choc pneumatique
 IT Chiave ad impulsi pneumatica
 ES Llave neumática de percusión
 CN 气动扳手

1/2" 12.7mm	TWIN HAMMER TYPE	0.63 MPa	184 l/min	1560 Nm
				



$L_{pa} = 87,0 \pm 1,0$ dB; $L_{wa} = 94,0 \pm 2,0$ dB; $a_h = 9,4 \pm 0,9$ m/s²

YATO 	[Nm]	
YT-09545	1560	5

EN Impact wrench
PL Klucz pneumatyczny
DE Druckluft-Schlagschrauber
RU Ударный пневматический гайковерт
CZ Klúč pneumatický
HU Pneumatikus ütvecsavarozó
RO Pistol pneumatic
FR Clé à choc pneumatique
IT Chiave ad impulsi pneumatica
ES Llave neumática de percusión
CN 双锤式气动冲击扳手

3/4"
19 mm

TWIN
HAMMER
TYPE

0.63
MPa

660
l/min

1300
Nm

5000
min⁻¹

G 3/8

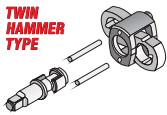

$L_{pa} = 92,0 \pm 3,0$ dB; $L_{wa} = 103,0 \pm 3,0$ dB; $a_n = 5,47 \pm 1,5$ m/s²

YATO	[Nm]	
YT-09564	1300	4

EN Impact wrench
PL Klucz pneumatyczny
DE Druckluft-Schlagschrauber
RU Ударный пневматический гайковерт
CZ Klúč pneumatický
HU Pneumatikus ütvecsavarozó
RO Pistol pneumatic
FR Clé à choc pneumatique
IT Chiave ad impulsi pneumatica
ES Llave neumática de percusión
CN 气动扳手

3/4"
19 mm

TWIN
HAMMER
TYPE

0.63
MPa

198
l/min

1630
Nm

5500
min⁻¹

COMPOSITE
BODY
KOMPOZYTOWY
KORPUS

G 3/8

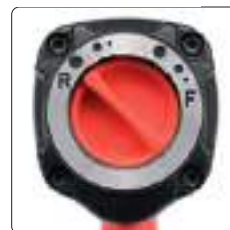
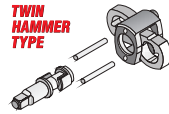

$L_{pa} = 100,6 \pm 3,0$ dB; $L_{wa} = 111,6 \pm 3,0$ dB; $a_n = 10,21 \pm 1,5$ m/s²

YATO	[Nm]	
YT-09571	1630	6

EN Impact wrench
PL Klucz pneumatyczny
DE Druckluft-Schlagschrauber
RU Ударный пневматический гайковерт
CZ Klúč pneumatický
HU Pneumatikus ütvecsavarozó
RO Pistol pneumatic
FR Clé à choc pneumatique
IT Chiave ad impulsi pneumatica
ES Llave neumática de percusión
CN 气动扳手

3/4"
19 mm

TWIN
HAMMER
TYPE

0.63
MPa

255
l/min

2300
Nm

7000
min⁻¹

COMPOSITE
BODY
KOMPOZYTOWY
KORPUS

STANDARD

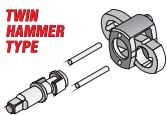

$L_{pa} = 97,9 \pm 3,0$ dB; $L_{wa} = 108,9 \pm 3,0$ dB; $a_n = 5,75 \pm 1,5$ m/s²

YATO	[Nm]	
YT-09575	2300	4

EN Impact wrench
PL Klucz pneumatyczny
DE Druckluft-Schlagschrauber
RU Ударный пневматический гайковерт
CZ Klúč pneumatický
HU Pneumatikus ütvecsavarozó
RO Pistol pneumatic
FR Clé à choc pneumatique
IT Chiave ad impulsi pneumatica
ES Llave neumática de percusión
CN 气动扳手

1"
25 mm

PINLESS
HAMMER
TYPE

0.63
MPa

560
l/min

2600
Nm

4000
min⁻¹

G 1/2

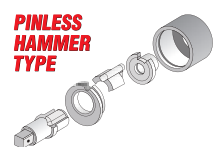

• Application: automotive service stations, trucks
• Strong, uniform impact

• Przeznaczenie: serwis, samochody ciężarowe
• Silny, jednolity uder

$L_{pa} = 94,1 \pm 2,8$ dB; $L_{wa} = 104,8 \pm 2,8$ dB; $a_n = 14,53 \pm 1,93$ m/s²

YATO	[Nm]	
YT-0959	2600	1

EN Impact wrench
 PL Klucz pneumatyczny
 DE Druckluft-Schlagschrauber
 RU Ударный пневматический гайковерт
 CZ Klíč pneumatický
 HU Pneumatikus ütvecsavarzó

RO Pistol pneumatic
 FR Clé à choc pneumatique
 IT Chiave ad impulsi pneumatica
 ES Llave neumática de percusión
 CN 气动冲击扳手

1" 25mm	PINLESS HAMMER TYPE	0.63 MPa	560 l/min	2600 Nm	4000 min ⁻¹	G 1/2	
------------	---------------------------	-------------	--------------	------------	---------------------------	-------	---

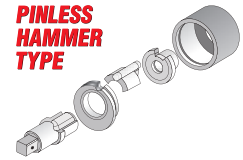



**PINLESS
HAMMER
TYPE**

• Application: automotive service stations, trucks
 • Strong, uniform impact

• Przeznaczenie: serwis, samochody ciężarowe
 • Silny, jednolity uder

$L_{pa} = 97,2 \pm 2,0$ dB; $L_{wa} = 107,7 \pm 2,8$ dB; $a_h = 23,58 \pm 4,76$ m/s²

YATO 	[Nm]	
YT-0960	2600	1

EN Impact wrench
 PL Klucz pneumatyczny
 DE Druckluft-Schlagschrauber
 RU Ударный пневматический гайковерт
 CZ Klíč pneumatický
 HU Pneumatikus ütvecsavarzó



RO Pistol pneumatic
 FR Clé à choc pneumatique
 IT Chiave ad impulsi pneumatica
 ES Llave neumática de percusión
 CN 气动冲击扳手

1" 25mm	PINLESS HAMMER TYPE	0.6-1.0 MPa	355 l/min	3200 Nm	3500 min ⁻¹	G 1/2	
------------	---------------------------	----------------	--------------	------------	---------------------------	-------	---



**PINLESS
HAMMER
TYPE**

$L_{pa} = 97,1 \pm 3,0$ dB; $L_{wa} = 108,1 \pm 3,0$ dB; $a_h = 13,75 \pm 1,5$ m/s²

YATO 	[Nm]	
YT-09615	3200	1

EN Impact wrench
 PL Klucz pneumatyczny
 DE Druckluft-Schlagschrauber
 RU Ударный пневматический гайковерт
 CZ Klíč pneumatický
 HU Pneumatikus ütvecsavarzó

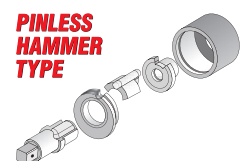

RO Pistol pneumatic
 FR Clé à choc pneumatique
 IT Chiave ad impulsi pneumatica
 ES Llave neumática de percusión
 CN 气动冲击扳手

1" 25mm	PINLESS HAMMER TYPE	1.0 MPa	450 l/min	4800 Nm	5000 min ⁻¹	G 1/2	
------------	---------------------------	------------	--------------	------------	---------------------------	-------	---



**PINLESS
HAMMER
TYPE**

$L_{pa} = 97,0 \pm 3,0$ dB; $L_{wa} = 108,0 \pm 3,0$ dB; $a_h = 12,579 \pm 1,5$ m/s²

YATO 	[Nm]	
YT-09618	4800	1

EN Impact wrench
 PL Klucz pneumatyczny
 DE Druckluft-Schlagschrauber
 RU Ударный пневматический гайковерт
 CZ Klíč pneumatický
 HU Pneumatikus ütvecsavarzó

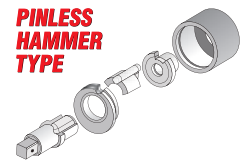

RO Pistol pneumatic
 FR Clé à choc pneumatique
 IT Chiave ad impulsi pneumatica
 ES Llave neumática de percusión
 CN 气动冲击扳手

1" 25mm	PINLESS HAMMER TYPE	0.63 MPa (max.)	650 l/min	5800 Nm	7000 min ⁻¹	G 1/2	
------------	---------------------------	-----------------------	--------------	------------	---------------------------	-------	---



**PINLESS
HAMMER
TYPE**

$L_{pa} = 84,4 \pm 3,0$ dB; $L_{wa} = 95,4 \pm 3,0$ dB; $a_h = 2,6 \pm 1,5$ m/s²

YATO 	[Nm]	
YT-09620	5800	1

- EN 3 in 1 air combo kit
PL Zestaw pneumatyczny 3 w 1
DE 3 in 1 Druckluft-Satz
RU Пневматический набор 3 в 1
CZ Pneumatická sada 3 v 1
HU 3 az 1-ben pneumatikus készlet
RO Kit aer comprimat 3 in 1
FR Ensemble pneumatique 3 en 1
IT Kit di utensili pneumatici 3 in 1
ES Set neumático 3 en 1
CN 棘扳手磨三合一工具



1/2" 12.7mm	0.63 MPa	113 l/min	85 Nm	180 mm ²
15000 min ⁻¹	18000 min ⁻¹	6 mm Ø	STANDARD	



$L_{pa} = 88,0 \pm 3,0$ dB; $L_{wa} = 99,0 \pm 3,0$ dB; $a_h = 3,95 \pm 1,5$ m/s²

- EN Ratchet air wrench
PL Grzechotka pneumatyczna
DE Druckluft-Ratschenschrauber
RU Пневмомрецовка
CZ Pneumatická ráčna
HU Préslevegős behajtó szerszám
RO Antrenor pneumatic
FR Clé à cliquet pneumatique
IT Chiave a cricchetto pneumatica
ES Carraca neumática
CN 气动棘轮扳手

1/2" 12.7mm	0.63 MPa	142 l/min	80 Nm
160 min ⁻¹	360° AIR EXHAUST WYDMUCH POWIETRZA	SPEED REGULATOR REGULACJA PRĘDKOŚCI	1.4 kg
	COMPOSITE BODY KOMPZYTOWY KORPUS	STANDARD	



ULTRA LIGHT

$L_{pa} = 94,0 \pm 3,0$ dB; $L_{wa} = 105,0 \pm 3,0$ dB; $a_h = 2,6 \pm 1,5$ m/s²

YATO	[Nm]	
YT-09803	80	12

- EN Ratchet air wrench
PL Grzechotka pneumatyczna
DE Druckluft-Ratschenschrauber
RU Пневмомрецовка
CZ Pneumatická ráčna
HU Préslevegős behajtó szerszám
- RO Antrenor pneumatic
FR Clé à cliquet pneumatique
IT Chiave a cricchetto pneumatica
ES Carraca neumática
CN 气动棘轮扳手

1/2" 12.7mm	0.62 MPa	110 l/min
68 Nm	160 min ⁻¹	STANDARD



$L_{pa} = 93,1 \pm 1,9$ dB; $L_{wa} = 104,4 \pm 2,7$ dB; $a_h = 19,98 \pm 2,47$ m/s²

YATO	[Nm]	
YT-0980	68	20

YATO	[Nm]	
YT-09860	85	10

- EN Ratchet air wrench
PL Grzechotka pneumatyczna
DE Druckluft-Ratschenschrauber
RU Пневмомрецовка
CZ Pneumatická ráčna
HU Préslevegős behajtó szerszám
- RO Antrenor pneumatic
FR Clé à cliquet pneumatique
IT Chiave a cricchetto pneumatica
ES Carraca neumática
CN 气动棘轮扳手

1/2" 12.7mm	0.62 MPa	120 l/min
80 Nm	160 min ⁻¹	STANDARD



$L_{pa} = 87,6 \pm 1,9$ dB; $L_{wa} = 97,7 \pm 2,7$ dB; $a_h = 14,83 \pm 1,96$ m/s²

YATO	[Nm]	
YT-0981	80	20

- EN Ratchet wrench kit
PL Zestaw z grzechotką pneumatyczną
DE Druckluft-Ratschenschrauber mit Zubehör
RU Пневмомрецовка в наборе
CZ Klič ráčnový pneumatický s příslušenstvím
HU Pneumatikus racsnikülés készlet
RO Cheie pneumatica cu accesorii
FR Clé à cliquet pneumatique
IT Chiave a cricchetto pneumatica
ES Juego con carraca neumática
CN 气动棘轮扳手套

1/2" 12.7mm	0.62 MPa	110 l/min	68 Nm
160 min ⁻¹	STANDARD	CrV	OIL POT OLIWIARKA



- 10, 11, 12, 13, 14, 17, 19 mm;
1/2" (12.7 mm) (L=75 mm);
1/2" (12.7 mm);
6 mm x 1/2" (12.7 mm);
PH2, PH3, PH4;
T20, T25, T27, T30, T40;
4, 5, 6, 7, 8 mm

$L_{pa} = 93,1 \pm 1,9$ dB; $L_{wa} = 104,4 \pm 2,7$ dB; $a_h = 19,98 \pm 2,47$ m/s²

YATO	[Nm]	
YT-0982	68	4

- EN Air grinder
- PL Szlifierka pneumatyczna prosta
- DE Drucklufterhandschleifer
- RU Шлифмашина пневматическая
- CZ Bruska přímá pneumatická
- HU Pneumatikus egyenescsiszoló
- RO Polizor pneumatic
- FR Mini ponceuse pneumatique
- IT Smerigliatrice diritta pneumatica
- ES Lijadora neumática recta
- CN 气动修磨机



0.62 MPa	160 l/min	20000 min ⁻¹
3, 6 mm Ø		

$L_{pa} = 100,7 \pm 2,4$ dB; $L_{wa} = 106,2 \pm 3,7$ dB; $a_n = 2,83 \pm 0,93$ m/s²

- EN Air grinder
- PL Szlifierka pneumatyczna prosta
- DE Drucklufterhandschleifer
- RU Шлифмашина пневматическая
- CZ Bruska přímá pneumatická
- HU Pneumatikus egyenescsiszoló
- RO Polizor pneumatic
- FR Mini ponceuse pneumatique
- IT Smerigliatrice diritta pneumatica
- ES Lijadora neumática recta
- CN 气动修磨机



ADJUSTABLE SPEED REGULATOR. REAR AIR EXHAUST CAN BE ROTATED 360°
REGULACJA PRĘDKOŚCI. MOŻLIWOŚĆ USTAWIENIA WYDMUCHU POWIETRZA O 360°

0.63 MPa	113 l/min	25000 min ⁻¹
6 mm Ø		



$L_{pa} = 88,0 \pm 3,0$ dB; $L_{wa} = 99,0 \pm 3,0$ dB; $a_n = 2,9 \pm 1,5$ m/s²

YATO	
YT-09632	20

YATO	
YT-0965	25

- EN Air grinder
- PL Szlifierka pneumatyczna prosta
- DE Drucklufterhandschleifer
- RU Шлифмашина пневматическая
- CZ Bruska přímá pneumatická
- HU Pneumatikus egyenescsiszoló
- RO Polizor pneumatic
- FR Mini ponceuse pneumatique
- IT Smerigliatrice diritta pneumatica
- ES Lijadora neumática recta
- CN 气动刻磨机

0.63 MPa	113 l/min	25000 min ⁻¹	6 mm Ø
360° AIR EXHAUST WYDMUCH POWIETRZA	SPEED REGULATOR REGULACJA PRĘDKOŚCI	0,33 kg	



$L_{pa} = 97,0 \pm 3,0$ dB; $L_{wa} = 108,0 \pm 3,0$ dB; $a_n = 0,9 \pm 1,5$ m/s²

YATO	
YT-09633	40

ULTRA LIGHT

- EN Pneumatic angle grinder
- PL Szlifierka pneumatyczna kątowa
- DE Ruckluft-Winkelschleifer
- RU Пневматическая угловая шлифовальная машина
- CZ Pneumatické úhlovou brusku
- HU Pneumatikus sarokcsiszoló
- RO Polizor unghiular pneumatic
- FR Pneumatique meuleuse d'angle
- IT Smerigliatrice angolare pneumatica
- ES Amoladora angular neumática
- CN 气动角磨

0.63 MPa	141 l/min	11000 min ⁻¹	125 x 16/22 mm
M10			



$L_{pa} = 87,0 \pm 3,0$ dB; $L_{wa} = 98,0 \pm 3,0$ dB; $a_n = 3,4 \pm 1,5$ m/s²

YATO	
YT-09675	8

- EN Pneumatic angle grinder
- PL Szlifierka pneumatyczna kątowa
- DE Ruckluft-Winkelschleifer
- RU Пневматическая угловая шлифовальная машина
- CZ Pneumatické úhlovou brusku
- HU Pneumatikus sarokcsiszoló
- RO Polizor unghiular pneumatic
- FR Pneumatique meuleuse d'angle
- IT Smerigliatrice angolare pneumatica
- ES Amoladora angular neumática
- CN 气动刻磨机

0.63 MPa	113 l/min	20000 min ⁻¹	6 mm Ø
360° AIR EXHAUST WYDMUCH POWIETRZA	SPEED REGULATOR REGULACJA PRĘDKOŚCI	0,48 kg	



$L_{pa} = 92,0 \pm 3,0$ dB; $L_{wa} = 103,0 \pm 3,0$ dB; $a_n = 1,4 \pm 1,5$ m/s²

YATO	
YT-09676	30

ULTRA LIGHT

EN Air sander
PL Szlifierka pneumatyczna mimośrodowa
DE Druckluft-Excenterschleifer
RU Шлифмашина эксцентриковая пневматическая
CZ Bruska pneumatická
HU Pneumatikus polírozó
RO Masina de slefuit pneumatica
FR Ponceuse pneumatique
IT Smerigliatrice orbitale pneumatica
ES Lijadora neumática excéntrica
CN 气动抛光机



ULTRA LIGHT

$L_{pa} = 87,0 \pm 3,0$ dB; $L_{wa} = 98,0 \pm 3,0$ dB; $a_n = 2,3 \pm 2,5$ m/s²

YATO	
YT-09730	20

EN Air sander
PL Szlifierka pneumatyczna mimośrodowa
DE Druckluft-Excenterschleifer
RU Шлифмашина эксцентриковая пневматическая
CZ Bruska pneumatická
HU Pneumatikus polírozó
RO Masina de slefuit pneumatica
FR Ponceuse pneumatique
IT Smerigliatrice orbitale pneumatica
ES Lijadora neumática excéntrica
CN 气动磨光机



$L_{pa} = 90,0 \pm 3,0$ dB; $L_{wa} = 101,0 \pm 3,0$ dB; $a_n = 4,4 \pm 2,5$ m/s²

YATO	
YT-09740	10

EN Air sander
PL Szlifierka pneumatyczna mimośrodowa
DE Druckluft-Excenterschleifer
RU Шлифмашина эксцентриковая пневматическая
CZ Bruska pneumatická
HU Pneumatikus polírozó
RO Masina de slefuit pneumatica
FR Ponceuse pneumatique
IT Smerigliatrice orbitale pneumatica
ES Lijadora neumática excéntrica
CN 气动磨光机



$L_{pa} = 90,0 \pm 3,0$ dB; $L_{wa} = 101,0 \pm 3,0$ dB; $a_n = 4,4 \pm 2,5$ m/s²

YATO	
YT-09739	10

EN Air sander
PL Szlifierka pneumatyczna mimośrodowa
DE Druckluft-Excenterschleifer
RU Шлифмашина эксцентриковая пневматическая
CZ Bruska pneumatická
HU Pneumatikus polírozó
RO Masina de slefuit pneumatica
FR Ponceuse pneumatique
IT Smerigliatrice orbitale pneumatica
ES Lijadora neumática excéntrica
CN 气动研磨机



$L_{pa} = 91,0 \pm 3,0$ dB; $L_{wa} = 105,0 \pm 4,0$ dB; $a_n = 10,3 \pm 1,2$ m/s²

YATO	
YT-09738	10

EN Air belt sander
PL Pneumatyczna szlifierka taśmowa
DE Pneumatische Bandschleifer
RU Пневматический шлифовальный
CZ Pneumatická pásová bruska
HU Pneumatikus szalagsziszoló
RO Polizor pneumatic cu banda
FR Ponceuse à bandes pneumatique
IT Levigatrice a nastro pneumatica
ES Lijadora de banda neumática
CN 气动砂磨机



Includes belts: P60, P80, P120
W zestawie pasy: P60, P80, P120

$L_{pa} = 93,0 \pm 3,0$ dB; $L_{wa} = 104,0 \pm 3,0$ dB; $a_n = 4,8 \pm 1,5$ m/s²

YATO	Abrasive belt size / Rozmiar taśmy ścierniej [mm]	
YT-09741	10x330	10

EN Air belt sander
PL Pneumatyczna szlifierka taśmowa
DE Pneumatische Bandschleifer
RU Пневматический шлифовальный
CZ Pneumatická pásová bruska
HU Pneumatikus szalagsziszoló
RO Polizor pneumatic cu banda
FR Ponceuse à bandes pneumatique
IT Levigatrice a nastro pneumatica
ES Lijadora de banda neumática
CN 气动砂磨机



Includes belts: P60, P80, P120
W zestawie pasy: P60, P80, P120

$L_{pa} = 93,0 \pm 3,0$ dB; $L_{wa} = 104,0 \pm 3,0$ dB; $a_n = 4,8 \pm 1,5$ m/s²

YATO	Abrasive belt size / Rozmiar taśmy ścierniej [mm]	
YT-09742	20x520	10

EN Air cut-off tool
 PL Przecinarka pneumatyczna
 DE Druckluft-Schneidmaschine
 RU Резак пневматический
 CZ Příčná bruska pneumatická
 HU Pneumatikus sarokcsiszoló
 RO Masina de taiat cu aer comprimat
 FR Coupeuse pneumatique
 IT Fresa pneumatica
 ES Cortadora neumática
 CN 气动角磨

0.65 MPa **127 l/min** **18000 min⁻¹** **75x9.5 mm** **STANDARD**



$L_{pa} = 87,0 \pm 3,0$ dB; $L_{wa} = 98,0 \pm 3,0$ dB; $a_n = 1,36 \pm 1,5$ m/s²

YATO **YT-09715** 10

EN Metal cutting discs
 PL Tarcze do cięcia metalu
 DE Metall-Trennscheiben
 RU Круги отрезные по металлу
 CZ Souprava kotoučů pro řezání kovu
 HU Vágókorong készlet fémhez
 RO Set de pânze de tăiat metal
 FR Set de disques pour métal
 IT Disco per taglio metallo
 ES Juego de discos para cortar metal
 CN 金属切割片组套



For YT-0993, YT-09715, YT-09717
 Dla YT-0993, YT-09715, YT-09717

YATO **YT-0994** 12/48

EN Air body saw
 PL Wyrzynarka pneumatyczna
 DE Luft Körper Säge
 RU Пила пневматическая сабельная
 CZ Pílka pneumatická na plech
 HU Pneumatikus kardfűrész
 RO Fierastrau pneumatic
 FR Scie sabre pneumatique
 IT Sega da traforo
 ES Sierra neumática
 CN 气锯



0.63 MPa **170 l/min** **9000 min⁻¹** **STANDARD**

$L_{pa} = 78,0 \pm 3,0$ dB; $L_{wa} = 89,0 \pm 3,0$ dB; $a_n = 23 \pm 1,5$ m/s²

YATO **YT-09955** 20

EN Air shears pistol type
 PL Nożyce pneumatyczne kątowe
 DE Pneumatische Schere
 RU Пневматические ножницы угловые
 CZ Pneumatické nůžky na plech
 HU Pneumatikus ollók
 RO Foarfeca pneumatica
 FR Cisailles pneumatiques
 IT Cesoiia pneumatica angolare
 ES Tijera neumática
 CN 气动剪刀



0.63 MPa **141 l/min** **1800 min⁻¹** **5.5 mm** **STANDARD**

max 1.2mm STEEL **max 1.4mm Al** **STANDARD**



$L_{pa} = 80,0 \pm 3,0$ dB; $L_{wa} = 91,0 \pm 3,0$ dB; $a_n = 6,5 \pm 1,5$ m/s²

YATO **YT-09944** 10

EN Air cut-off tool
 PL Przecinarka pneumatyczna
 DE Druckluft-Schneidmaschine
 RU Резак пневматический
 CZ Příčná bruska pneumatická
 HU Pneumatikus sarokcsiszoló
 RO Masina de taiat cu aer comprimat
 FR Coupeuse pneumatique
 IT Fresa pneumatica
 ES Cortadora neumática
 CN 气动切割机

0.8 MPa **170 l/min** **18000 min⁻¹** **75x9.5 mm** **360°** **STANDARD**

0.7 kg **SPEED REGULATOR REGULACJA PRĘDKOŚCI** **ULTRA LIGHT ULTRALEKKI** **COMPOSITE BODY KOMPOZYTOWY KORPUS** **STANDARD**



ULTRA LIGHT

$L_{pa} = 90,0 \pm 3,0$ dB; $L_{wa} = 101,0 \pm 3,0$ dB; $a_n = 1,2 \pm 1,5$ m/s²

YATO **YT-09717** 20

EN Air shears
PL Nożyce pneumatyczne proste
DE Pneumatische Schere
RU Пневматические ножницы прямые
CZ Pneumatiké nůžky na plech
HU Pneumatikus ollók
RO Foarfeca pneumatică
FR Ciseaux pneumatiques
IT Cesoia pneumatica diritta
ES Tijera neumática
CN 气动剪刀

0.63 MPa	141 l/min	2500 min ⁻¹	5.5 mm
max 1.2 mm STEEL STAL	max 1.4 mm Al	STANDARD	



$L_{pa} = 90,0 \pm 3,0$ dB; $L_{wa} = 101,0 \pm 3,0$ dB; $a_h = 4,6 \pm 1,5$ m/s²

YATO

YT-09945



15

EN Air drill
PL Wiertarka pneumatyczna
DE Druckluft-Bohrmaschine
RU Пневматическая дрель
CZ Vrtáčka vzduchová
HU Pneumatikus fúró
RO Mașină de găurit pneumatică
FR Perceuse pneumatique
IT Trapano ad aria compressa
ES Taladradora neumática
CN 气钻

0.63 MPa	198 l/min	700 min ⁻¹	max \varnothing 10 mm
	1.7 kg	STANDARD	



$L_{pa} = 89,7 \pm 3,0$ dB; $L_{wa} = 100,7 \pm 3,0$ dB; $a_h = 0,89 \pm 1,5$ m/s²

YATO

YT-09702



12

EN Air drill
PL Wiertarka pneumatyczna
DE Druckluft-Bohrmaschine
RU Пневматическая дрель
CZ Vrtáčka vzduchová
HU Pneumatikus fúró
RO Mașină de găurit pneumatică
FR Perceuse pneumatique
IT Trapano ad aria compressa
ES Taladradora neumática
CN 气钻

0.63 MPa	141 l/min	20000 min ⁻¹	max \varnothing 10 mm
360° AIR EXHAUST WYDMUCH POWIETRZA	SPEED REGULATOR REGULACJA PRĘDKOŚCI	0.66 kg	ULTRA LIGHT ULTRALEKKI
COMPOSITE BODY KOMPÓZYTOWY KORPUS	STANDARD		



ULTRA LIGHT

$L_{pa} = 92,0 \pm 3,0$ dB; $L_{wa} = 103,0 \pm 3,0$ dB; $a_h = 6,2 \pm 1,5$ m/s²

YATO

YT-09695



20

EN Air drill
PL Wiertarka pneumatyczna
DE Druckluft-Bohrmaschine
RU Пневматическая дрель
CZ Vrtáčka vzduchová
HU Pneumatikus fúró
RO Mașină de găurit pneumatică
FR Perceuse pneumatique
IT Trapano ad aria compressa
ES Taladradora neumática
CN 气钻

0.63 MPa	113 l/min	1800 min ⁻¹	max \varnothing 10 mm	0.9 kg
		ULTRA LIGHT ULTRALEKKI	COMPOSITE BODY KOMPÓZYTOWY KORPUS	STANDARD



ULTRA LIGHT

$L_{pa} = 98,0 \pm 3,0$ dB; $L_{wa} = 109,0 \pm 3,0$ dB; $a_h = 2,8 \pm 1,5$ m/s²

YATO

YT-09703



10

EN Air hammer
PL Młotek pneumatyczny
DE Druckluft-Schlaghammer
RU Зубило пневматическое
CZ Sekáč vzduchový
HU Pneumatikus vésőkészlet pisztollyal

RO Ciocan pneumatic
FR Marteau pneumatique
IT Martello pneumatica
ES Martillo neumático
CN 冲击式气铲

0.62 MPa	113 l/min	T 3200 min ⁻¹
	STANDARD	



$L_{pa} = 96,3 \pm 1,3$ dB; $L_{wa} = 107,7 \pm 2,5$ dB; $a_h = 2,62 \pm 9,1$ m/s²

YATO

YT-0990



10

EN Air hammer
PL Młotek pneumatyczny
DE Druckluft-Schlaghammer
RU Зубило пневматическое
CZ Sekáč vzduchový
HU Pneumatikus vésőkészlet pisztollyal

RO Ciocan pneumatic
FR Marteau pneumatique
IT Martello pneumatica
ES Martillo neumático
CN 冲击式气铲

0.63 MPa	113 l/min	T 4500 min ⁻¹	0.95 kg
		ULTRA LIGHT ULTRALEKKI	COMPOSITE BODY KOMPÓZYTOWY KORPUS



$L_{pa} = 95,0 \pm 3,0$ dB; $L_{wa} = 106,0 \pm 3,0$ dB; $a_h = 20,0 \pm 4,5$ m/s²

YATO

YT-09904



10

ULTRA LIGHT

EN Air needle scaler
 PL Pneumatyczny młotek igłowy
 DE Luft-Nadel-Scaler
 RU Пневматический игольчатый отбойник
 CZ Pneumatické jehlové kladivo
 HU Pneumatikus tűs rozsdaleverő
 RO Pistol pneumatic de curățat cu ace
 FR Dérouilleur décapeur pneumatique
 IT Scrostatore pneumatico ad aghi
 ES Limpiador de agujas neumáticas
 CN 气动除锈器

0.63 MPa **99** l/min **T** 4000 min⁻¹ **x19** NEEDLES 10x7 **STANDARD**



$L_{pa} = 97,0 \pm 3,0$ dB; $L_{wa} = 108,0 \pm 3,0$ dB; $a_h = 18,9 \pm 1,5$ m/s²

YATO **YT-09912** 6

EN Air needle scaler
 PL Pneumatyczny młotek igłowy
 DE Luft-Nadel-Scaler
 RU Пневматический игольчатый отбойник
 CZ Pneumatické jehlové kladivo
 HU Pneumatikus tűs rozsdaleverő
 RO Pistol pneumatic de curățat cu ace
 FR Dérouilleur décapeur pneumatique
 IT Scrostatore pneumatico ad aghi
 ES Limpiador de agujas neumáticas
 CN 气动除锈器

0.63 MPa **48** l/min **T** 3000 min⁻¹ **x13** NEEDLES 10x7 **STANDARD**



$L_{pa} = 87,8 \pm 3,0$ dB; $L_{wa} = 98,8 \pm 3,0$ dB; $a_h = 6,9 \pm 1,18$ m/s²

YATO **YT-09913** 25

EN Air needle scaler
 PL Pneumatyczny młotek igłowy
 DE Luft-Nadel-Scaler
 RU Пневматический игольчатый отбойник
 CZ Pneumatické jehlové kladivo
 HU Pneumatikus tűs rozsdaleverő
 RO Pistol pneumatic de curățat cu ace
 FR Dérouilleur décapeur pneumatique
 IT Scrostatore pneumatico ad aghi
 ES Limpiador de agujas neumáticas
 CN 气动除锈器

0.63 MPa **113** l/min **T** 4500 min⁻¹ **x19** NEEDLES 10x7 **STANDARD**



$L_{pa} = 100,0 \pm 3,0$ dB; $L_{wa} = 111,0 \pm 3,0$ dB; $a_h = 13,0 \pm 1,5$ m/s²

YATO **YT-09910** 8

EN Needle head
 PL Glowka igłowa
 DE Nadelkopf
 RU Головка пневматического молотка
 CZ Jehlová hlavice
 HU Tűs rozsdaleverő fej
 RO Cap rezerva pt. ciocan pneumatic cu ace
 FR Tête à aiguilles
 IT Testa per scrostatore ad aghi
 ES Cabezal de agujas
 CN 除锈筒

x19 NEEDLES 10x7

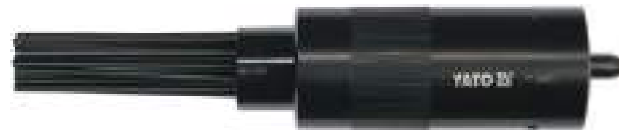

For YT-09910
 Dla YT-09910

YATO **YT-09911** 20

EN Shank chisel for air hammer
 PL Dłuta do młotka pneumatycznego
 DE Lufthammer Meißel-Set
 RU Комплект зубил для пневматического молотка
 CZ Dláta pro pneumatické kladivo
 HU Véső készlet pneumatikus véső kalapácsolhoz

RO Set dalti pt. ciocan pneumatic
 FR Ensemble marteau burineur
 IT Set di scalpelli per martelli pneumatici
 ES Juego de martillos para martillos neumáticos
 CN 气动铲刀

4 PCS

120 mm



For YT-0990, 81133, YT-09904
 Dla YT-0990, 81133, YT-09904

YATO **YT-09901** 50

EN Inflating gun
 PL Pistolet do pompowania
 DE Inflatorpistole
 RU Пистолет для накачивания
 CZ Pistolet na čerpání z manometrem
 HU Pumpáló pisztoly nyomásmérővel
 RO Pistol cu manometru
 FR Pistolet pour gonflage de pneus avec manomètre
 IT Pistola per gonfiaggio
 ES Pistola de bombeo con manometro
 CN 充气枪

0.6 MPa (max.) **44** cm **360°**



$L_{pa} = 89,0 \pm 2,5$ dB; $L_{wa} = 100,0 \pm 2,5$ dB; $a_h = <2,5$ m/s²

YATO **YT-23701** 20

EN Inflating gun
PL Pistolet do pompowania
DE Inflatorpistole
RU Пистолет для накачивания
CZ Pistolet na čerpání z manometrem
HU Pumpáló pisztoly nyomásmérővel
RO Pistol cu manometru
FR Pistolet pour gonflage de pneus avec manomètre
IT Pistola per gonfiaggio
ES Pistola de bombeo con manometro
CN 充气枪



$L_{pa} = 89,0 \pm 2,5$ dB; $L_{wa} = 100,0 \pm 2,5$ dB; $a_n = <2,5$ m/s²

YATO	
YT-2370	8/40

EN Inflating gun
PL Pistolet do pompowania
DE Inflatorpistole
RU Пистолет для накачивания
CZ Pistolet na čerpání z manometrem
HU Pumpáló pisztoly nyomásmérővel
RO Pistol cu manometru
FR Pistolet pour gonflage de pneus avec manomètre
IT Pistola per gonfiaggio
ES Pistola de bombeo con manometro
CN 充气枪



$L_{pa} = 89,0 \pm 2,5$ dB; $L_{wa} = 100,0 \pm 2,5$ dB; $a_n = <2,5$ m/s²

YATO	
YT-23703	20

EN Inflating gun
PL Pistolet do pompowania
DE Inflatorpistole
RU Пистолет для накачивания
CZ Pistolet na čerpání z manometrem
HU Pumpáló pisztoly nyomásmérővel
RO Pistol cu manometru
FR Pistolet pour gonflage de pneus avec manomètre
IT Pistola per gonfiaggio
ES Pistola de bombeo con manometro
CN 充气枪



$L_{pa} = 89,0 \pm 2,5$ dB; $L_{wa} = 100,0 \pm 2,5$ dB; $a_n = <2,5$ m/s²

YATO	
YT-23702	10/40

EN Inflating head
PL Glowica do pompowania
DE Klemmnippel (universal)
RU Насадка на насос под шланг
CZ Hlava na čerpání
HU Pumpafej
RO Cap pt. pompat
FR Mandrin de pompe
IT Testa per il pompaggio
ES Cabeza de bombeo
CN 万用接头



YATO	Connector diameter / Šrednica króčca [mm]	
YT-2371	6	50/300
YT-2372	8	50/300

EN Spray gun with fluid cup
PL Pistolet natryskowy
DE Lackierpistole mit Fließbecher
RU Пистолет - распылитель с верхним бачком

CZ Pistolet na lakování z nádrží
HU Festékszór pisztoly alsó- és felsőtartályos
RO Pistol de vopsit cu rezervor inferior
FR Pistolet à peinture

IT Pistola vernice
ES Pistola de barniz
CN 喷枪



0.3 MPa
410 l/min
1.4 mm
0.6 L
HVLP



$L_{pa} = 74,0$ dB; $L_{wa} = 85,0$ dB; $a_n = <2,5$ m/s²

YATO	
YT-2340	20

0.3 MPa
410 l/min
1.5 mm
0.6 L
HVLP



$L_{pa} = 76,0$ dB; $L_{wa} = 87,0$ dB; $a_n = <2,5$ m/s²

YATO	
YT-2341	20

0.4 MPa
380 l/min
1.8 mm
1 L



$L_{pa} = 79,0$ dB; $L_{wa} = 90,0$ dB; $a_n = <2,5$ m/s²

YATO	
YT-2346	10

0.3 MPa
220 l/min
0.8 mm
0.1 L
HVLP



$L_{pa} = 67,0$ dB; $L_{wa} = 78,0$ dB; $a_n = <2,5$ m/s²

YATO	
YT-2357	20

EN Air vacuum cleaner
 PL Odkurzacz pneumatyczny
 DE Druckluftstaubsauger
 RU Пневматический пылесос
 CZ Pneumatický vysavač
 HU Pneumatikus porszívó
 RO Aspirator cu aer comprimat
 FR Aspirateur pneumatique
 IT Aspirapolvere pneumatico
 ES Aspirador neumático
 CN 吹吸尘枪



0.62 MPa (max.)
 25 mm
 AI
 STANDARD

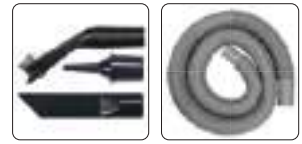

$L_{pA} = 83,0 \pm 3,0$ dB; $L_{wA} = 94,0 \pm 3,0$ dB; $a_h = <2,5$ m/s²

EN Cleaning foam gun
 PL Pistolet do wytwarzania piany
 DE Schaumpistole
 RU Пистолет для образования пены
 CZ Pistolet pro vytváření pěny
 HU Habpisztoly
 RO Pistol pt. spuma
 FR Pistolet pour faire de la mousse
 IT Pistola per erogazione schiuma
 ES Pistola generadora de espuma
 CN 发动机清洗枪

0.62 MPa (max.)
 113 l/min
 220 mm
 1L
 AI
 STANDARD



$L_{pA} = 85,0 \pm 3,0$ dB; $L_{wA} = 96,0 \pm 3,0$ dB; $a_h = <2,5$ m/s²

YATO 
 YT-23640 10

EN Cleaning foam gun
 PL Pistolet do wytwarzania piany
 DE Schaumpistole
 RU Пистолет для образования пены
 CZ Pistolet pro vytváření pěny
 HU Habpisztoly
 RO Pistol pt. spuma
 FR Pistolet pour faire de la mousse
 IT Pistola per erogazione schiuma
 ES Pistola generadora de espuma
 CN 泡沫枪

0.62 MPa (max.)
 113 l/min
 TURBO NOZZLE DYSZA TURBO
 1L
 AI
 STANDARD



$L_{pA} = 85,0 \pm 3,0$ dB; $L_{wA} = 96,0 \pm 3,0$ dB; $a_h = <2,5$ m/s²

YATO 
 YT-23641 10

EN Blow gun with extension
 PL Pistolet do przedmuchiwania z przedłużką
 DE Gebläsepistole mit Verlängerung
 RU Пистолет для продувки с удлинителем
 CZ Pistolet na profukování dlouhá
 HU Rövid előléfűvő pisztoly
 RO Pistol lung pt. suflat
 FR Pistolet pour purger
 IT Pistola di soffiaggio
 ES Pistola de soplado
 CN 吹尘枪

0.8 MPa (max.)
 1/4" 6.3mm
 AI
 STANDARD



$L_{pA} = 91,0$ dB; $L_{wA} = 102,0$ dB; $a_h = <2,5$ m/s²

YATO 
 YT-2373 20/40

EN Blow gun with extension
 PL Pistolet do przedmuchiwania z przedłużką
 DE Gebläsepistole mit Verlängerung
 RU Пистолет для продувки с удлинителем
 CZ Pistolet na profukování dlouhá
 HU Rövid előléfűvő pisztoly
 RO Pistol lung pt. suflat
 FR Pistolet pour purger
 IT Pistola di soffiaggio
 ES Pistola de soplado
 CN 吹尘枪

0.8 MPa (max.)
 110 mm
 BRASS MOSIADZ
 PP
 STANDARD



$L_{pA} = 89,0$ dB; $L_{wA} = 100,0$ dB; $a_h = <2,5$ m/s²

YATO 
 YT-23731 20/40

EN Blow gun with extension
 PL Pistolet do przedmuchiwania z przedłużką
 DE Gebläsepistole mit Verlängerung
 RU Пистолет для продувки с удлинителем
 CZ Pistolet na profukování dlouhá
 HU Rövid előléfűvő pisztoly
 RO Pistol lung pt. suflat
 FR Pistolet pour purger
 IT Pistola di soffiaggio
 ES Pistola de soplado
 CN 吹尘枪

0.8 MPa (max.)
 320 mm
 PP

BRASS MOSIADZ
 STANDARD



$L_{pA} = 89,0$ dB; $L_{wA} = 100,0$ dB; $a_h = <2,5$ m/s²

YATO 
 YT-23732 30/60

EN Blow gun with extension
PL Pistolet do przedmuchiwania z przedłużką
DE Gebläsepistole mit Verlängerung
RU Пистолет для продувки с удлинителем
CZ Pistolet na profukování dlouhá
HU Rövid előfúvó pisztoly
RO Pistol lung pt. suflat
FR Pistolet pour purger
IT Pistola di soffiaggio
ES Pistola de soplado
CN 吹尘枪

0.8 MPa (max.) 520 mm PP BRASS MOSIADZ STANDARD 



$L_{pA} = 89,0$ dB; $L_{wA} = 100,0$ dB; $a_h = <2,5$ m/s²

EN Short air blow gun with turbo
PL Pistolet do przedmuchiwania krótki turbo
DE Turbo-Biaspistole, kurz
RU Короткий турбо пистолет для продувки
CZ Profukovací pistole krátká turbo
HU Fúvató pisztoly rövid turbó
RO Pistol de suflat scurt, funcție turbo
FR Soufflette à air comprimée courte turbo
IT Pistola per soffiaggio corte turbo
ES Pistola de soplado, corta turbo
CN 增压吹尘枪

0.62 MPa 45 mm TURBO NOZZLE DYSZA TURBO STANDARD 



$L_{pA} = 86,0 \pm 3,0$ dB; $L_{wA} = 97,0 \pm 3,0$ dB; $a_h = <2,5$ m/s²



YATO  YT-23722  50

EN Washing gun
PL Pistolet do ropowania
DE Waschpistole
RU Пистолет для нефтеевания
CZ Pistole na ropování + nádrž
HU Olajzópisztoly + tartály
RO Pistol (dozator) cu rezervor pt. motorină
FR Pistolet à l'huile
IT Pistola di lavaggio con nafta
ES Pistola de petrolear
CN 喷水枪

0.8 MPa 130 l/min 0.85L AI 



$L_{pA} = 92,0$ dB; $L_{wA} = 103,0$ dB; $a_h = <2,5$ m/s²

YATO  YT-2374  2/12

YATO  YT-23733  30/60

EN Long air blow gun with turbo
PL Pistolet do przedmuchiwania dlugi turbo
DE Turbo-Biaspistole, lang
RU Длинный турбо пистолет для продувки
CZ Profukovací pistole dlouhá turbo
HU Fúvató pisztoly hosszú turbó
RO Pistol de suflat lung, funcție turbo
FR Soufflette à air comprimée longue turbo
IT Pistola per soffiaggio lungo turbo
ES Pistola de soplado, larga turbo
CN 长嘴增压吹尘枪

0.62 MPa (max.) 110 mm TURBO NOZZLE DYSZA TURBO STANDARD 



$L_{pA} = 86,0 \pm 3,0$ dB; $L_{wA} = 97,0 \pm 3,0$ dB; $a_h = <2,5$ m/s²



YATO  YT-23723  25

EN Air sand blaster
PL Pistolet do piaskowania z węzłem
DE Pistole zum Sandstrahlen
RU Пескоструйный пистолет
CZ Pískovací pistole s hadicí
HU Homokszóró pisztoly tömlővel
RO Pistol de sablat
FR Pistolet de sablage avec tuyau
IT Pistola sabbiatrica
ES Pistola para limpieza con chorro de arena con manguera
CN 吹气枪

0.8 MPa 160 l/min 1/4" 6.3mm 6.3mm 1m AI 



$L_{pA} = 90,0$ dB; $L_{wA} = 101,0$ dB; $a_h = <2,03$ m/s²

YATO  YT-2375  10

- EN Gun suitable for sand-blasting
- PL Pistolet do piaskowania ze zbiornikiem
- DE Sandstrahlpistole
- RU Пескоструйный пистолет
- CZ Pískovací pistole se zásobníkem
- HU Homokszóró pisztoly tartállyal
- RO Pistol de sablat
- FR Pistolet de sablage avec réservoir
- IT Pistola sabbiatrica con serbatoio
- ES Pistola para limpieza con chorro de arena con recip
- CN 喷枪



0.8 MPa	160 l/min	1 L	AI	
---------	-----------	-----	----	--

$L_{pA} = 91,0 \text{ dB}$; $L_{wA} = 102,0 \text{ dB}$; $a_s = 2,03 \text{ m/s}^2$

YATO	
YT-2376	20

- EN Work bench
- PL Stojak lakierniczy rozstawny
- DE Lackierständer, verstellbar
- RU Раздвижная лакировочная стойка
- CZ Stojan lakýrnický rozkládací
- HU Kinyitható lakkozó állvány
- RO Suport extensibil pt. lacuit
- FR Support à peindre
- IT Supporto pieghevole
- ES Montante plegable para barnizar
- CN 工作台



max 10 kg		58x65 cm
max 150 kg		108x45 cm

- EN Mini filter
- PL Filtr
- DE Filter
- RU Минифильтр
- CZ Filtr
- HU Szűrő
- RO Minifiltru
- FR Vidange mini
- IT Filtro
- ES Filtro
- CN 微型过滤器



1.4 MPa (max.)
8 cm ³
1/4"
6.3mm

YATO	
YT-5555	1

YATO	
YT-2380	25/50

- EN Pressure reducing valve with manometer
- PL Reduktor ciśnienia z manometrem
- DE Druckminderer mit Manometer
- RU Клапан уменьшения давления с манометром
- CZ Redukční ventil s manometrem
- HU Nyomáscsökkentő szelep nyomásmérővel
- RO Valva cu reductiepresiune + manometru
- FR Réducteur avec manomètre
- IT Regolatore di pressione con manometro
- ES Reductor + manometro
- CN 带表调压减压阀

1.2 MPa (max.)
1/4"
6.3mm



YATO	
YT-2381	25/50

- EN Filter - reducer
- PL Filtr - reduktor
- DE Druckfilter - Druckminderer
- RU Фильтр - редуктор
- CZ Filtr derukční ventil
- HU Szűrő - nyomásszabályzó
- RO Filtru cu reductor
- FR Réducteur avec filtre et manomètre
- IT Filtro regolatore
- ES Reductor + filtro
- CN 过滤器

0.93 MPa (max.)
15 cm ³
1/4"
6.3mm
max °C 60



YATO	
YT-2382	25/50

- EN Filter - reducer
- PL Filtr - reduktor
- DE Druckfilter - Druckminderer
- RU Фильтр - редуктор
- CZ Filtr derukční ventil
- HU Szűrő - nyomásszabályzó
- RO Filtru cu reductor
- FR Réducteur avec filtre et manomètre
- IT Filtro regolatore
- ES Reductor + filtro
- CN 过滤器

0.93 MPa (max.)
90 cm ³
1/2"
12.7mm
max °C 60



YATO	
YT-2383	25/50

- EN Air filter regulator and lubricator
PL Zespół filtrujący, reduktor + smarownica
DE Druckfilter - Druckminderer + Entöler
RU Фильтр-редуктор + смазочный прибор
CZ Redukční ventil s odlučovačem oleje
HU Levegőelőkészítő
RO Filtru cu reduktor
FR Filtre régulateur lubrificateur pour air comprimé
IT Filtro regolatore lubrificatore
ES Juego de filtro reductor + engrasador
CN 气动三联件



0.93 MPa (max.)
25cm³ FILTER FILTR
15cm³ LUBRICATOR SMAROWNICA
1/4" 6.3mm
max °C 60

- EN Air filter regulator and lubricator
PL Zespół filtrujący, reduktor + smarownica
DE Druckfilter - Druckminderer + Entöler
RU Фильтр-редуктор + смазочный прибор
CZ Redukční ventil s odlučovačem oleje
HU Levegőelőkészítő
RO Filtru cu reduktor
FR Filtre régulateur lubrificateur pour air comprimé
IT Filtro regolatore lubrificatore
ES Juego de filtro reductor + engrasador
CN 气动三联件



0.93 MPa (max.)
90cm³ FILTER FILTR
60cm³ LUBRICATOR SMAROWNICA
1/4" 6.3mm
max °C 60

YATO

YT-2384

25/50

- EN Air splitter
PL Rozdzielacz pneumatyczny z regulacją
DE Druckluftverteiler mit Regelung
RU Пневмораспределитель с регулированием
CZ Pneumatický rozdělovač s regulací
HU Pneumatikus elosztó szabályozóval
RO Distributor aer comprimat
FR Distributeur pneumatique avec régulation
IT Distributore pneumatico con regolazione
ES Distribuidor neumático ajustable
CN 气路分流器



0.63 MPa
1.3 MPa (max.)
x2 OUTLET WYSŁĘCIE
x2 ADJUSTABLE OUTLET REGULOWNE WYŚLĘCIE
STANDARD

YATO

YT-2386

5

- EN Air hose with quick coupler
PL Wąż techniczny zbrojony z szybkozłączami
DE Luftschlauch mit Schnellkupplung
RU Шланг пневматический с быстроразъемным соединением
CZ Hadice vzduchová s rychlospojškami
HU Levegőtömítő apa csatlakozóval
RO Furtun aer comprimat cuple rapide
FR Le tuyau d'air avec raccords rapides
IT Rinforzato tecnico tubo flessibile con rapido
ES Manguera de aire del con los acopladores rápidos
CN 气管



2.0 MPa (max.)
PVC
STANDARD

YATO	Internal diameter / Średnica wewnętrzna [mm]	L [m]	
YT-24220	8	10	10
YT-24221	8	20	8
YT-24224	10	10	10
YT-24225	10	20	8

- EN Spiral tube with quick coupling
PL Wąż spiralny z szybkozłączem
DE Spiralschlauch mit Schnellkupplung
RU Шланг спиральный с быстрым соединением
CZ Spirálová vzduchová hadice
HU Levegős spiráltömítő gyorscsatlakozóval
RO Tub spiralat cu, cuplare rapida
FR Tuyau spirale en polyurethane
IT Tubo a spirale con rapido
ES Manguera espiral
CN 气管



1.2 MPa (max.)
PU
STANDARD

YATO	Internal diameter / Średnica wewnętrzna [mm]	External diameter / Średnica zewnętrzna [mm]	L [m]	
YT-24201	5.5	8	5	50
YT-24202	5.5	8	10	25
YT-24203	5.5	8	15	25
YT-24204	6.5	10	5	50
YT-24205	6.5	10	10	20
YT-24206	6.5	10	15	25
YT-24207	8.0	12	5	20
YT-24208	8.0	12	10	25
YT-24209	8.0	12	15	20

- EN Hybrid air hose
PL Przewód pneumatyczny hybrydowy
DE Hybrid-Druckluftleitung
RU Пневматический гибридный шланг
CZ Hybridní pneumatická hadice
HU Hibrid pneumatikus vezeték
RO Furtun aer, hibrid
FR Tuyau pneumatique hybride
IT Condotto pneumatico ibrido
ES Conducto neumático híbrido
CN 橡胶高弹管



2.0 MPa (max.)
PVC NBR HYBRID
G 1/4 BSPT

YATO	Internal diameter / Średnica wewnętrzna [mm]	L [m]	
YT-24230	6.5	10	10
YT-24231	6.5	20	5
YT-24232	6.5	30	4

EN Hybrid air hose
 PL Przewód pneumatyczny hybrydowy
 DE Hybrid-Druckluftleitung
 RU Пневматический гибридный шланг
 CZ Hybridní pneumatická hadice
 HU Hibrid pneumatikus vezeték
 RO Furtun aer, hibrid
 FR Tuyau pneumatique hybride
 IT Condotto pneumatico ibrido
 ES Conducto neumático híbrido
 CN 橡胶高弹管

2.0 MPa (max.) PVC NBR HYBRID G 1/4 BSPT



YATO	Internal diameter / Średnica wewnętrzna [mm]	L [m]	
YT-24233	8	10	10
YT-24234	8	20	5
YT-24235	8	30	4

EN Hybrid air hose
 PL Przewód pneumatyczny hybrydowy
 DE Hybrid-Druckluftleitung
 RU Пневматический гибридный шланг
 CZ Hybridní pneumatická hadice
 HU Hibrid pneumatikus vezeték
 RO Furtun aer, hibrid
 FR Tuyau pneumatique hybride
 IT Condotto pneumatico ibrido
 ES Conducto neumático híbrido
 CN 橡胶高弹管

2.0 MPa (max.) PVC NBR HYBRID G 3/8 BSPT



YATO	Internal diameter / Średnica wewnętrzna [mm]	L [m]	
YT-24236	12.5	10	10
YT-24237	12.5	20	5
YT-24238	12.5	30	4

EN Air hose reel
 PL Wąż pneumatyczny na zwijaku
 DE Luftschnlauch am Haspel
 RU Шланг пневматический на катушке
 CZ Naviják se vzduchovou hadicí
 HU Levegő tömlő dob es
 RO Furtun de aer tumbur
 FR Bobine de tuyau d'air et de
 IT Tubo pneumatico sull'avvolgitore
 ES Carrete de manguera de aire
 CN 气动软管卷盘

2.0 MPa (max.) 15 m \varnothing 10 mm PVC STANDARD x4 ANCHORS KOTWY



YATO	
YT-24240	2

EN Air hose reel
 PL Wąż pneumatyczny na zwijaku
 DE Luftschnlauch am Haspel
 RU Шланг пневматический на катушке
 CZ Naviják se vzduchovou hadicí
 HU Levegő tömlő dob es
 RO Furtun de aer tumbur
 FR Bobine de tuyau d'air et de
 IT Tubo pneumatico sull'avvolgitore
 ES Carrete de manguera de aire
 CN 气动软管卷盘

2.0 MPa (max.) 15 m \varnothing 9.5 mm PVC NBR HYBRID STANDARD x4 ANCHORS KOTWY



YATO	
YT-24241	2

EN Air hose reel
 PL Wąż pneumatyczny na zwijaku
 DE Luftschnlauch am Haspel
 RU Шланг пневматический на катушке
 CZ Naviják se vzduchovou hadicí
 HU Levegő tömlő dob es
 RO Furtun de aer tumbur
 FR Bobine de tuyau d'air et de
 IT Tubo pneumatico sull'avvolgitore
 ES Carrete de manguera de aire
 CN 气管卷管器

2.0 MPa (max.) 10 m \varnothing 8 mm G 1/4 BSPT AUTO REWIND AUTOMATYCZNE ZWIJANIE x4 ANCHORS KOTWY



YATO	
YT-24242	4

EN Air hose reel
 PL Wąż pneumatyczny na zwijaku
 DE Luftschnlauch am Haspel
 RU Шланг пневматический на катушке
 CZ Naviják se vzduchovou hadicí
 HU Levegő tömlő dob es
 RO Furtun de aer tumbur
 FR Bobine de tuyau d'air et de
 IT Tubo pneumatico sull'avvolgitore
 ES Carrete de manguera de aire
 CN 气管卷管器

2.0 MPa (max.) 14 m \varnothing 6.5 mm G 1/4 BSPT AUTO REWIND AUTOMATYCZNE ZWIJANIE x4 ANCHORS KOTWY PVC



YATO	
YT-24243	4

EN Air hose reel
PL Wąż pneumatyczny na zwijaku
DE Luftschnlauch am Haspel
RU Шланг пневматический на катушке
CZ Naviják se vzduchovou hadicí
HU Levegő tömlő dob es
RO Furtun de aer tumbur
FR Bobine de tuyau d'air et de
IT Tubo pneumatico sull'avvolgitore
ES Carrete de manguera de aire
CN 英寸卷管器

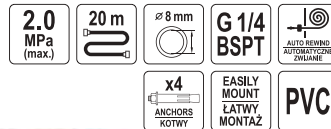

YATO
YT-24244



2

EN Air hose reel
PL Wąż pneumatyczny na zwijaku
DE Luftschnlauch am Haspel
RU Шланг пневматический на катушке
CZ Naviják se vzduchovou hadicí
HU Levegő tömlő dob es
RO Furtun de aer tumbur
FR Bobine de tuyau d'air et de
IT Tubo pneumatico sull'avvolgitore
ES Carrete de manguera de aire
CN 英寸卷管器



YATO
YT-24245



1

EN Air hose reel
PL Wąż pneumatyczny na zwijaku
DE Luftschnlauch am Haspel
RU Шланг пневматический на катушке
CZ Naviják se vzduchovou hadicí
HU Levegő tömlő dob es
RO Furtun de aer tumbur
FR Bobine de tuyau d'air et de
IT Tubo pneumatico sull'avvolgitore
ES Carrete de manguera de aire
CN 英寸卷管器



YATO
YT-24246



1

EN Air hose reel
PL Wąż pneumatyczny na zwijaku
DE Luftschnlauch am Haspel
RU Шланг пневматический на катушке
CZ Naviják se vzduchovou hadicí
HU Levegő tömlő dob es
RO Furtun de aer tumbur
FR Bobine de tuyau d'air et de
IT Tubo pneumatico sull'avvolgitore
ES Carrete de manguera de aire
CN 英寸卷管器



YATO
YT-24250



1

EN Quick coupler
PL Szybkozłączce
DE Schnellkupplung
RU Быстрое соединение
CZ Rychlospojka
HU Gyorscsatlakozó
RO Mufa rapida pt. pistol pneumatic
FR Raccord rapide
IT Attacco rapido
ES Conexión de la entrada de aire
CN 快速接头

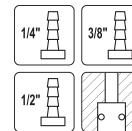
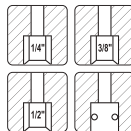
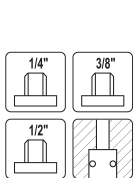

YATO	Thread size / Rozmiar gwintu	Icon
YT-2390	G1/4	20/120
YT-2391	G3/8	20/120
YT-2392	G1/2	20/120

YATO	Thread size / Rozmiar gwintu	Icon
YT-2393	G1/4	20/120
YT-2394	G3/8	20/120
YT-2395	G1/2	20/120

YATO	Connector diameter / Średnica króćca [mm]	Icon
YT-2396	6	20/120
YT-2397	8	20/120
YT-2398	10	20/120

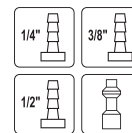
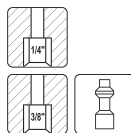
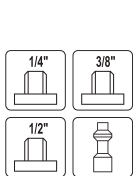

YATO	Thread size / Rozmiar gwintu	Icon
YT-2399	G1/4	50/250
YT-2401	G3/8	50/250
YT-2402	G1/2	50/250

YATO	Thread size / Rozmiar gwintu	Icon
YT-2403	G1/4	50/250
YT-2404	G3/8	50/250

YATO	Connector diameter / Średnica króćca [mm]	Icon
YT-2405	6	50/250
YT-2406	8	50/250
YT-2407	10	50/250

EN Quick coupler RU Быстрое соединение RO Mufa rapida pt. pistol pneumatic ES Conexión de la entrada de aire
 PL Szybkozłącze CZ Rychlospojka FR Raccord rapide CN 欧式气管接头
 DE Schnellkupplung HU Gyorscsatlakozó IT Attacco rapido

2
PCS

STANDARD



YATO

YT-24100 6/60



YATO

YT-24101 6/60



YATO

YT-24102 6/60

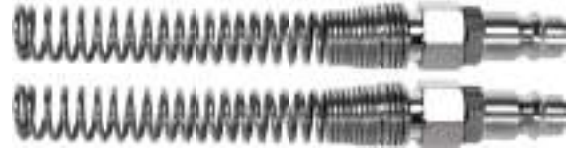

YATO

YT-24103 6/60

EN 2 way quick coupler
 PL Szybkozłącze podwójne
 DE Zwei-wege Schnellkupplung
 RU Двусторонняя быстроразъемные соединения
 CZ Two-way rychlospojka
 HU Levegőelosztó kettes gyorscsat
 RO Distribuitoare cuple rapide
 FR Dérivation type y en cuivre
 IT Raccordo ottone con vie
 ES Manera 2 manguera de aire pase de acoplamiento rápido
 CN 三通万用插嘴



DOUBLE EXHAUST
PODWÓJNY WYLOT

2x G 1/4" (12.3 mm)

G 3/8" (15.8 mm)

BALL JOINT
ZŁĄCZE KULOWE

BRASS
MOSIĄDZ

YATO

YT-24091 25/50

EN Quick coupler CZ Rychlospojka IT Attacco rapido
 PL Szybkozłącze HU Gyorscsatlakozó ES Conexión de la entrada de aire
 DE Schnellkupplung RO Mufa rapida pt. pistol pneumatic CN 万用插嘴
 RU Быстрое соединение FR Raccord rapide

BRASS
MOSIĄDZ

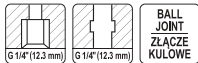

YATO

YT-24092 50/100

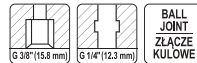

YATO

YT-24093 50/100



YATO

YT-24094 50/100

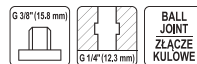

YATO

YT-24095 50/100

EN Air hose swivel connector RO Conector pivotant pt. furtun de aer
 PL Przegub pneumatyczny FR Raccord pneumatique
 DE Druckluft Gelenk-Kupplung IT Giunto pneumatico
 RU Пневматическое соединение ES Junta neumática
 CZ Pneumatický kloub CN 万向接头
 HU Pneumatikus forgócsukló

1/4"
6.3mm

360°

AI



YATO

YT-24130 20/100

EN Pneumatic grease injector
PL Smarownica pneumatyczna
DE Druckluft-Fettpresse
RU Пневматический нагнетатель смазки
CZ Maznice pneumatická
HU Pneumatikus zsírzó
RO Pompă pneumatică pt. gresat
FR Pompe à graisse pneumatique
IT Ingrassatore pneumatico
ES Bomba de engrase neumática lubricar
CN 气动黄油机



$L_{pA} = 97,0 \pm 3,0$ dB; $L_{wA} = 108,0 \pm 3,0$ dB

YATO	[]	[Icon]
YT-07067	12	1

EN Pneumatic grease injector
PL Smarownica pneumatyczna
DE Druckluft-Fettpresse
RU Пневматический нагнетатель смазки
CZ Maznice pneumatická
HU Pneumatikus zsírzó
RO Pompă pneumatică pt. gresat
FR Pompe à graisse pneumatique
IT Ingrassatore pneumatico
ES Bomba de engrase neumática lubricar
CN 气动黄油机



$L_{pA} = 97,0 \pm 3,0$ dB; $L_{wA} = 108,0 \pm 3,0$ dB

YATO	[]	[Icon]
YT-07069	45	1

EN Pneumatic grease injector
PL Smarownica pneumatyczna
DE Druckluft-Fettpresse
RU Пневматический нагнетатель смазки
CZ Maznice pneumatická
HU Pneumatikus zsírzó
RO Pompă pneumatică pt. gresat
FR Pompe à graisse pneumatique
IT Ingrassatore pneumatico
ES Bomba de engrase neumática lubricar
CN 气动黄油机



$L_{pA} = 99,0 \pm 3,0$ dB; $L_{wA} = 110,0 \pm 3,0$ dB

YATO	[]	[Icon]
YT-07068	30	1

EN Pneumatic oiling machine
PL Pneumatyczny napełniacz do oleju
DE Pneumatischer Oleinfüller
RU Пневматический наполнитель для масла
CZ Pneumatické plnidlo oleje
HU Pneumatikus olajfeltöltő
RO Gresor pneumatic
FR Pompes et de remplissage d'huile pneumatique
IT Dispositivo di riempimento olio
ES Dispositivo de llenado de aceite
CN 齿轮油加油机

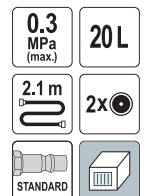

$L_{pA} = 101,2 \pm 3,0$ dB; $L_{wA} = 119,8 \pm 3,0$ dB

YATO	[]	[Icon]
YT-07195	20	1

EN Pneumatic oil drain extractor
 PL Zlewarko-wysysarka pneumatyczna
 DE Druckluft Ölabsauggerät / Ölauffanggerät
 RU Маслосборная установка пневматическая
 CZ Pneumatická odsávačka vyjetého oleje
 HU Pneumatikus fáradtolaj gyűjtő / leszívó
 RO Rezervor decantare ulei uzat
 FR Récupérateur d'huile par aspiration
 IT Aspiratore-recuperatore pneumatico
 ES Recuprador de aceite de succión
 CN 抽接油机



0.7-0.8 MPa
SUCTION
ODSISSANIE

0.18 MPa
EJECTION
OPROZNIANIE

70 L

6
SUCTION PROBES
SONDY SPACE

4x 

 STANDARD



$L_{pA} = 101,2 \pm 3,0$ dB; $L_{wA} = 119,8 \pm 3,0$ dB

YATO 		
YT-07191	70	1

EN Air grease gun
 PL Smarownica pneumatyczna
 DE Druckluft-Fettpresse
 RU Шприц для смазки пневматический
 CZ Mazací lis pneumatický
 HU Pneumatikus zsírzó
 RO Pistol de gresat pneumatic
 FR Pistolet à graisse pneumatique
 IT Ingrassatore pneumatico
 ES Pistola engrasadora neumática
 CN 气动黄油枪



0.62 MPa

IN 0.2-0.62 MPa

OUT 30-40 MPa

400 cm³

28 l/min

 STANDARD



$L_{pA} = 85,0 \pm 3,0$ dB; $L_{wA} = 96,0 \pm 3,0$ dB; $a_0 = \leq 2,5$ m/s²

YATO 	
YT-07055	10

EN Pneumatic oil drain extractor
 PL Zlewarko-wysysarka pneumatyczna
 DE Druckluft Ölabsauggerät / Ölauffanggerät
 RU Маслосборная установка пневматическая
 CZ Pneumatická odsávačka vyjetého oleje
 HU Pneumatikus fáradtolaj gyűjtő / leszívó
 RO Rezervor decantare ulei uzat
 FR Récupérateur d'huile par aspiration
 IT Aspiratore-recuperatore pneumatico
 ES Recuprador de aceite de succión
 CN 抽接油机



0.7-0.8 MPa
SUCTION
ODSISSANIE

0.18 MPa
EJECTION
OPROZNIANIE

90 L

6
SUCTION PROBES
SONDY SPACE

4x 

 STANDARD



$L_{pA} = 101,2 \pm 3,0$ dB; $L_{wA} = 119,8 \pm 3,0$ dB

YATO 		
YT-07190	90	1

EN Air grease gun
 PL Smarownica pneumatyczna
 DE Druckluft-Fettpresse
 RU Шприц для смазки пневматический
 CZ Mazací lis pneumatický
 HU Pneumatikus zsírzó
 RO Pistol de gresat pneumatic
 FR Pistolet à graisse pneumatique
 IT Ingrassatore pneumatico
 ES Pistola engrasadora neumática
 CN 气动黄油枪



0.63 MPa

IN 0.2-0.63 MPa

OUT 6-28 MPa

400 cm³

220 l/min

 STANDARD



$L_{pA} = \leq 70,0$ dB; $L_{wA} = \leq 80,0$ dB; $a_0 = \leq 2,5$ m/s²

YATO 	
YT-07057	10

EN Pneumatic riveting machine
PL Nitownica pneumatyczna
DE Druckluft Nietzange
RU Пневматический заклепочник
CZ Pneumatická nýtovačka
HU Pneumatikus popszegecsűző
RO Presa pneumatica pt. nituit
FR Riveuse pneumatique
IT Rivettatrice pneumatica
ES Máquina remachadora
CN 气动拉铆枪

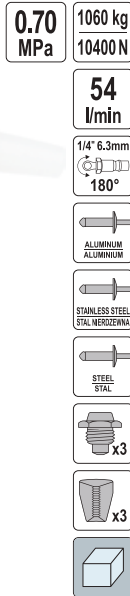

$L_{pa} = 83,6 \pm 1,9$ dB; $L_{wa} = 97,4 \pm 2,8$ dB; $a_h = 0,66 \pm 0,21$ m/s²

YATO	Ø [mm]	Max. piston stroke / Maks. skok tłoka silownika [mm]	F [kg]	F [N]	
YT-36171	2,4, 3,2, 4, 4,8, 5	18	757-1060	7430-10400	10

EN Pneumatic riveting machine
PL Nitownica pneumatyczna
DE Druckluft Nietzange
RU Пневматический заклепочник
CZ Pneumatická nýtovačka
HU Pneumatikus popszegecsűző
RO Presa pneumatica pt. nituit
FR Riveuse pneumatique
IT Rivettatrice pneumatica
ES Máquina remachadora
CN 气动拉铆枪

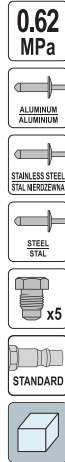

$L_{pa} = 81,2 \pm 3,0$ dB; $L_{wa} = 92,2 \pm 3,0$ dB; $a_h = 0,6 \pm 0,56$ m/s²

YATO	Ø [mm]	Max. piston stroke / Maks. skok tłoka silownika [mm]	F [kg]	F [N]	
YT-3618	2,4, 3,2, 4, 4,8, 6,4	19	1894	18561	6

EN Pneumatic stapler
PL Zszywacz pneumatyczny
DE Drucklufthefter
RU Пневматический сшиватель
CZ Pneumatická sešivačka
HU Pneumatikus tűzőgép
RO Capsator pneumatic
FR Agrafeuse pneumatique
IT Cucitrice pneumatica
ES Engrapadora pneumática
CN 气动码钉枪

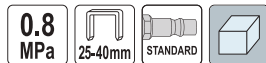

$L_{pa} = 88,6 \pm 2,5$ dB; $L_{wa} = 101,6 \pm 2,5$ dB; $a_h = 2,98 \pm 1,5$ m/s²

YATO	
YT-09202	10

EN Pneumatic riveting machine
PL Nitownica pneumatyczna
DE Druckluft Nietzange
RU Пневматический заклепочник
CZ Pneumatická nýtovačka
HU Pneumatikus popszegecsűző
RO Presa pneumatica pt. nituit
FR Riveuse pneumatique
IT Rivettatrice pneumatica
ES Máquina remachadora
CN 气动拉铆枪

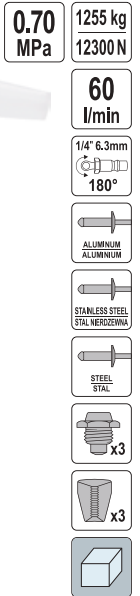

$L_{pa} = 87,2 \pm 2,3$ dB; $L_{wa} = 94,5 \pm 3,0$ dB; $a_h = 0,54 \pm 0,15$ m/s²

YATO	Ø [mm]	Max. piston stroke / Maks. skok tłoka silownika [mm]	F [kg]	F [N]	
YT-36177	4, 4,8, 5, 5,4, 6, 6,4	20	1255	12300	10

EN Pneumatic stapler
PL Zszywacz pneumatyczny
DE Drucklufthefter
RU Пневматический сшиватель
CZ Pneumatická sešivačka
HU Pneumatikus tűzőgép
RO Capsator pneumatic
FR Agrafeuse pneumatique
IT Cucitrice pneumatica
ES Engrapadora pneumática
CN 气动码钉枪

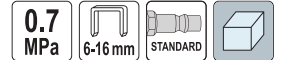

$L_{pa} = 88,0 \pm 2,5$ dB; $L_{wa} = 99,0 \pm 2,5$ dB; $a_h = 3,5 \pm 1,5$ m/s²

YATO	
YT-09201	10

EN Pneumatic stapler
PL Zszywacz pneumatyczny
DE Drucklufthefter
RU Пневматический сшиватель
CZ Pneumatická sešivačka
HU Pneumatikus tűzőgép
RO Capsator pneumatic
FR Agrafeuse pneumatique
IT Cucitrice pneumatica
ES Engrapadora pneumática
CN 直钉/码钉二合一钉枪



$L_{pa} = 87,8 \pm 2,5$ dB; $L_{wa} = 100,8 \pm 2,5$ dB; $a_h = 2,91 \pm 1,5$ m/s²

YATO	
YT-09203	10

EN Pneumatic roofing coil nailer
 PL Gwoździarka bębnowa na gwoździe papowe
 DE Pneumatischer Coilnagler für Innenausbau
 RU Пневматический нейлер для гвоздей
 CZ Pneumatická hřebíkováčka na šindele
 HU Pneumatiská naglóšanas ierice
 RO Pistol pneumatic cu bobină pt. bătut cuie pe acoperiș
 FR Cloueuse de charpente pneumatique à bandes
 IT Chiodatrice pneumatica
 ES Clavadora neumática de bobina para tejados
 CN 气动屋顶枪

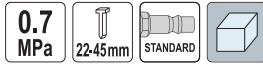

$L_{pA} = 100,3 \pm 2,5$ dB; $L_{wA} = 111,3 \pm 2,5$ dB; $a_n = 11,3 \pm 1,5$ m/s²

YATO	
YT-09211	3

EN Pneumatic roofing coil nailer
 PL Gwoździarka bębnowa na gwoździe papowe
 DE Pneumatischer Coilnagler für Innenausbau
 RU Пневматический нейлер для гвоздей
 CZ Pneumatická hřebíkováčka na šindele
 HU Pneumatiská naglóšanas ierice
 RO Pistol pneumatic cu bobină pt. bătut cuie pe acoperiș
 FR Cloueuse de charpente pneumatique à bandes
 IT Chiodatrice pneumatica
 ES Clavadora neumática de bobina para tejados
 CN 卷钉枪

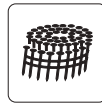
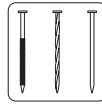
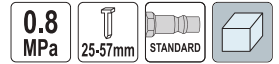

$L_{pA} = 88,6 \pm 2,5$ dB; $L_{wA} = 101,6 \pm 2,5$ dB; $a_n = 3,73 \pm 0,8$ m/s²

YATO	
YT-09212	3

EN Pneumatic roofing coil nailer
 PL Gwoździarka bębnowa na gwoździe papowe
 DE Pneumatischer Coilnagler für Innenausbau
 RU Пневматический нейлер для гвоздей
 CZ Pneumatická hřebíkováčka na šindele
 HU Pneumatiská naglóšanas ierice
 RO Pistol pneumatic cu bobină pt. bătut cuie pe acoperiș
 FR Cloueuse de charpente pneumatique à bandes
 IT Chiodatrice pneumatica
 ES Clavadora neumática de bobina para tejados
 CN 卷钉枪

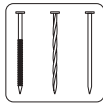
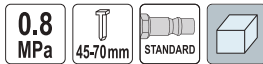

$L_{pA} = 101,7 \pm 2,5$ dB; $L_{wA} = 116,7 \pm 2,5$ dB; $a_n = 4,09 \pm 0,9$ m/s²

YATO	
YT-09213	3

EN Pneumatic roofing coil nailer
 PL Gwoździarka bębnowa na gwoździe papowe
 DE Pneumatischer Coilnagler für Innenausbau
 RU Пневматический нейлер для гвоздей
 CZ Pneumatická hřebíkováčka na šindele
 HU Pneumatiská naglóšanas ierice
 RO Pistol pneumatic cu bobină pt. bătut cuie pe acoperiș
 FR Cloueuse de charpente pneumatique à bandes
 IT Chiodatrice pneumatica
 ES Clavadora neumática de bobina para tejados
 CN 卷钉枪

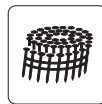
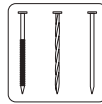
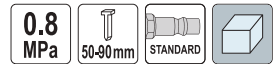

$L_{pA} = 92,3 \pm 2,5$ dB; $L_{wA} = 105,3 \pm 2,5$ dB; $a_n = 5,37 \pm 1,5$ m/s²

YATO	
YT-09214	2

EN Collated screws for metal
 PL Wkręty na taśmie do metalu
 DE Magazinierete Schrauben für Metall
 RU Саморезы в ленте по металлу
 CZ Šrouby do kovu na páse
 HU Szalaglátras csavar fémhez

RO Banda suruburi pt. metal
 FR Vis pour métal en bande
 IT Viti per metallo a nastro
 ES Tornillos en tira para metal
 CN 螺丝钉

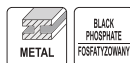

BLACK PHOSPHATE FOSFATYZOWANY



YATO	Ø [mm]	L [mm]	Screw head drive type / Rodzaj nacięcia łba	pcs / szt.	
YT-09440	3.5	25	PH2	1000	10
YT-09442	3.5	35	PH2	1000	10

EN Collated screws for wood
 PL Wkręty na taśmie do drewna
 DE Magazinierete Schrauben für Holz
 RU Саморезы в ленте по дереву
 CZ Šrouby do dřeva na páse
 HU Szalaglátras csavar fához

RO Banda suruburi pt. lemn
 FR Vis pour bois en bande
 IT Viti per legno a nastro
 ES Tornillos en tira para madera
 CN 螺丝钉

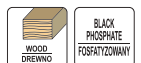

WOOD DREWNO BLACK PHOSPHATE FOSFATYZOWANY



YATO	Ø [mm]	L [mm]	Screw head drive type / Rodzaj nacięcia łba	pcs / szt.	
YT-09460	3.9	35	PH2	1000	10
YT-09461	3.9	45	PH2	1000	8



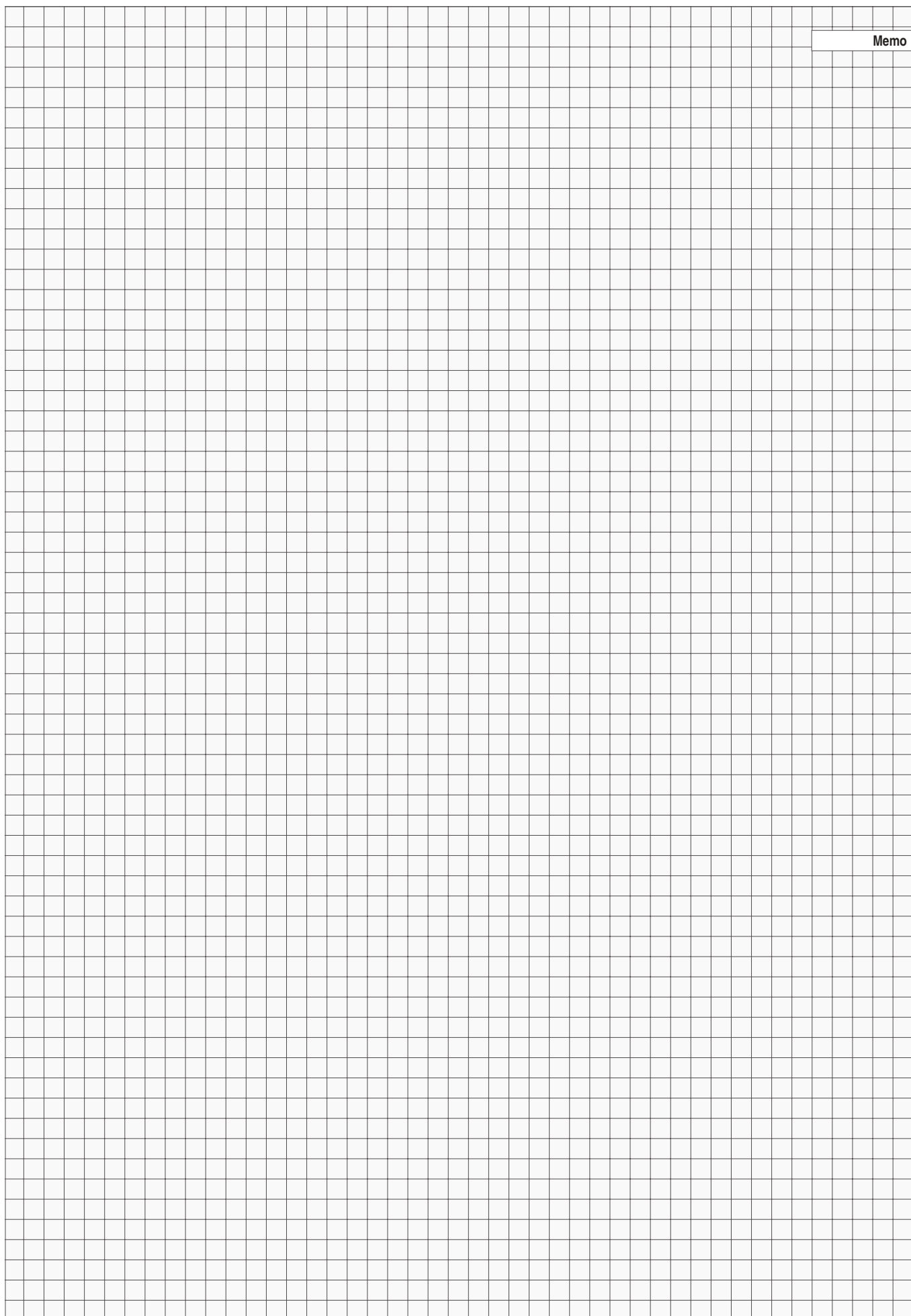









Memo



16

Special automotive tools & equipment
Narzędzia i wyposażenie
warsztatu samochodowego



Furniture & cabinets Meble i szafki			Fuel pipe pliers Szczypce motoryzacyjne		
	345-367			395-399	
Furniture Meble			Engine repair tools Narzędzia do obsługi silnika		
	345			400-432	
Roller cabinets with tools insert Szafki serwisowe z narzędziami			Piston ring compressors Zaciskacze do pierścieni		
	348			400	
Tool cabinets Szafki serwisowe			Honing machines & accessories Honorownice i akcesoria		
	354			400	
Workbenches Stoły warsztatowe			Engine repair and diagnostic tools Narzędzia do diagnostyki i naprawy silników		
	357			402	
Tools in PVC trays Zestawy narzędzi do szuflad			Brake system tools Narzędzia do obsługi układu hamulcowego		
	357			433-440	
Accessories for tool cabinets & workbenches Akcesoria do szafek i stołów			Suspension system tools Narzędzia do obsługi podwozia		
	357			440-445	
Hermetic tool boxes Walizki narzędziowe hermetyczne			Spring clamps & accessories Ściągacze do sprężyn i akcesoria		
	367-368			440	
Tool boxes Skrzynki narzędziowe			Shock absorber nut sets Zestawy nasadek do amortyzatorów		
	368-369			441	
Lubrication system tools Narzędzia do obsługi układu smarowania			Tire valve stem inserter Przeciągacze do zaworów gumowych		
	370-376			441	
Oil filter wrenches & sets Klucze do filtra oleju i zestawy			Wheel balance pliers Szczypce do wyważania kół		
	370			442	
Oil drain plug sockets Klucze do spustu oleju			Deep thin wall impact sockets Udarowe klucze nasadowe do felg aluminiowych		
	372			442	
Grease guns & accessories Smarownice ręczne i akcesoria			Wheel wrenches Klucze do kół		
	373			443	
Oil cans Oliwiarki			Impact wrenches Klucze udarowe		
	376			444	
Oil and fuel pumps Pompy do oleju oraz paliwa			Tire levers Łyżki do opon		
	376			445	
Pullers Ściągacze			Workshop tools Narzędzia warsztatowe		
	377-392			445-455	
Pullers Ściągacze			Inspection tools Narzędzia inspekcyjne		
	377			445	
Roller stud extractor sets Zestawy ściągaczy do szpilek			Magnetic pick up tools Chwytki magnetyczne		
	385			445	
Upholstery removers Ściągacze do tapicerki			Magnetic trays Tacki magnetyczne		
	391			446	
Car window tools Narzędzia do szyb samochodowych			Workshop seats Taborety warsztatowe		
	392			448	
Special pullers Ściągacze specjalistyczne			Workshop creepers Leżanki warsztatowe		
	392-394			448	
Air condition tools Narzędzia do klimatyzacji			Workshop mats Maty warsztatowe		
	394			448	
			Voltage testers Próbniki napięcia		
				449	
			Tapes Taśmy		
				449	
			Number & letter stamps Znaczniki cyfrowe i literowe		
				449	
			Thread repair sets & accessories Zestawy do naprawy gwintów i akcesoria		
				449	
			Pressure gauges Wskaźniki ciśnienia		
				452	





Pumps	
Pompki	452
Compressors	
Kompresory	453
Air wedges	
Poduszki montażowe	455
Tire racks	
Stojaki na koła	455

Funnels, oil drainer & drainer pans		
Lejki, miski i zlewarki do oleju	455-457	

Bottle & floor jacks		
Dźwigniki słupkowe i podnośniki	458-459	

Vehicle ramps & jack stands		
Najazdy i podstawki pod samochód	460	

Porta power kits		
Rozpieraki hydrauliczne	460-461	

Battery chargers, jump starters, power inverters & battery testers		
Prostowniki, urządzenia rozruchowe, przetwornice napięcia i testery akumulatorów	461-465	

Refractometers		
Refraktometry	465	

Workshop cable reels		
Przedłużacze warsztatowe	466	

Workshop equipment		
Sprzęt warsztatowy	466-469	

Chain blocks		
Wciągarki łańcuchowe	466	
Lever blocks		
Wciągarki łańcuchowe dźwigniowe	466	
Hand pullers		
Wciągarki linowe, ręczne	466	
Transmission jacks		
Podnośniki skrzyni biegów	467	
Parts washers		
Mylki warsztatowe	467	
Sandblaster cabinets & accessories		
Piaskarki kabinowe i akcesoria	467	
Shop cranes & shop presses		
Żurawie i prasy warsztatowe	468	

Workshop standardized parts		
Normalia motoryzacyjne	470-486	

CREATE YOUR WORKPLACE - STWÓRZ SWOJE MIEJSCE PRACY



YT-08931
High workshop cabinet
Szafka warsztatowa wysoka

YT-08935
Wall cabinet
Szafka podwieszana

YT-08936
Hook panel
Panel perforowany

YT-08938
YT-08939
Worktop
Blat roboczy

YT-08934
Workshop cabinet
Szafka warsztatowa

YT-08933
Workshop cabinet
Szafka warsztatowa

- EN High workshop cabinet
- PL Szafka warsztatowa wysoka
- DE Hoher Werkstattschrank
- RU Шкаф для мастерской, высокий
- CZ Skříňka pro ukládání nástrojů
- HU Szekrény szerszámok tárolására
- RO Dulap depozitare
- FR Armoire de rangement
- IT Armadio da officina alto
- ES Gabinete de almacenamiento
- CN 高柜



660x457
x2000
mm

x3
SHELVES
POCKET

ADJUSTABLE
FEET
REGULOWANE
STOPY

2x 



- EN Working cabinet
- PL Szafka warsztatowa
- DE Werkzeugkasten
- RU Портативный ящик для инструментов
- CZ Přenosná skříňka na nářadí
- HU Hordozható szerszámok láda
- RO Dulap pt. scule
- FR Servante d'atelier
- IT Banco da lavoro armadio
- ES Cajonera portátil
- CN 工具柜



660x457
x863
mm

4x 

ADJUSTABLE
FEET
REGULOWANE
STOPY

BALL
BEARINGS
ŁOŻYSKA
KULKOWE

2x 



Drawer quantity / Liczba szuflad

YT-08933

4



1

- EN Working cabinet
- PL Szafka warsztatowa
- DE Werkzeugkasten
- RU Портативный ящик для инструментов
- CZ Přenosná skříňka na nářadí
- HU Hordozható szerszámok láda
- RO Dulap pt. scule
- FR Servante d'atelier
- IT Banco da lavoro armadio
- ES Cajonera portátil
- CN 双门矮柜



660x457
x863
mm

SHELF
POŁKA

ADJUSTABLE
FEET
REGULOWANE
STOPY

2x 



YT-08931



1



YT-08934



1

EN Wall cabinet
 PL Szafka podwieszana
 DE Hängeschrank
 RU Настенный инструментальный шкаф
 CZ Nástěnná skříň
 HU Fali szekrény
 RO Dulap de perete
 FR Armoire murale
 IT Armadio sospeso
 ES Gabinete de pared
 CN 小墙柜

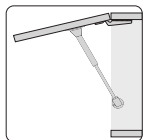

YT-08935



1

EN Worktop
 PL Blat roboczy
 DE Werkstatt Tischplatte
 RU Столешница для мастерской
 CZ Pracovní deska
 HU Munkalap
 RO Blat de lucru
 FR Plan de travail
 IT Piano di lavoro
 ES Encimera
 CN 木质工作台面



YT-08938



1

EN Strengthening element
 PL Wzmocnienie blatu
 DE Verstärkungselement
 RU Укрепление столешницы
 CZ Podpůrný prvek
 HU Asztali támogatás
 RO Tabla
 FR Support de table
 IT Rinforzo del piano di lavoro
 ES Soporte de mesa
 CN 工作台挂板



For YT-08939
 Dla YT-08939



YT-08940



5

EN Shelf
 PL Półka
 DE Regal
 RU Полка
 CZ Polica
 HU Polc
 RO Raft
 FR Étagère
 IT Scaffale
 ES Estante
 CN 层板



For YT-08931, YT-08934
 Dla YT-08931, YT-08934



YT-08932



5

EN Worktop
 PL Blat roboczy
 DE Werkstatt Tischplatte
 RU Столешница для мастерской
 CZ Pracovní deska
 HU Munkalap
 RO Blat de lucru
 FR Plan de travail
 IT Piano di lavoro
 ES Encimera
 CN 木质工作台面



YT-08939



1

EN Hook panel
 PL Panel perforowany
 DE Perforierte Wand
 RU Стенка с перфорацией
 CZ Děrovaná stěna
 HU Perforált fal
 RO Perete perforat
 FR Mur perforé
 IT Pannello forato
 ES Pared perforada
 CN 网孔板

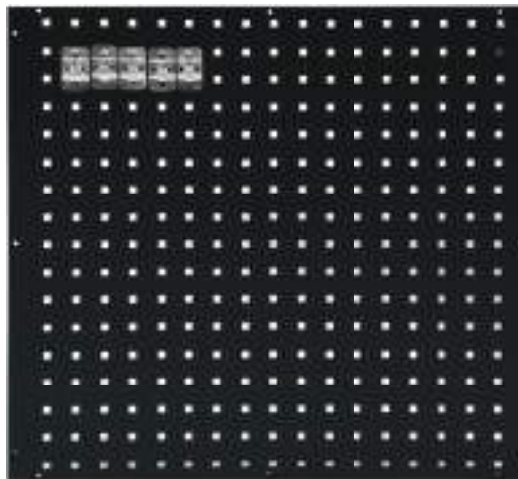

YT-08936



1

EN Hook panel support
PL Stelaż do paneli perforowanych
DE Verstärkungselement Perforierte Wand
RU Каркас для стенки с перфорацией
CZ Podpůrný prvek děrovaná stěna
HU Asztali támogatás perforált fal
RO Cadru de metal
FR Panneaux muraux perforés pour le soutien
IT Telaio per pannelli forati
ES Paneles de pared perforados de soporte
CN 工具柜



For YT-08936 x 3
Dla YT-08936 x 3

YATO	
YT-08941	1

EN Hook panel support
PL Stelaż do paneli perforowanych
DE Verstärkungselement Perforierte Wand
RU Каркас для стенки с перфорацией
CZ Podpůrný prvek děrovaná stěna
HU Asztali támogatás perforált fal
RO Cadru de metal
FR Panneaux muraux perforés pour le soutien
IT Telaio per pannelli forati
ES Paneles de pared perforados de soporte
CN 工具柜



For YT-08936 x 2
Dla YT-08936 x 2

YATO	
YT-08942	1

EN Power tool holder
PL Półka na elektronarzędzia
DE Elektrowerkzeug-Aufbewahrungshalterung
RU Полка для шуруповертов
CZ Držák závěsný na elektrické nářadí
HU Elektromos szerszámtartó
RO Suport scule electrice
FR Support pour outils électriques
IT Mensola porta elettrotrattensili
ES Estante para herramientas eléctricas
CN 电动工具架



576x225
x55
mm

x6



YATO	Socket quantity / Liczba kieszeni	
YT-09091	6	10

EN Power tool organizer
PL Półka na elektronarzędzia
DE Elektrowerkzeug-Aufbewahrungsregal
RU Полка для электроинструмента
CZ Závěsný organizér na elektrické nářadí
HU Elektromos szerszámtartó polc

RO Organizator pt. scule electrice
FR Support pour outils électriques
IT Mensola porta elettrotrattensili
ES Estante para herramientas eléctricas
CN 电动工具架

465x405
x225
mm

x4



YATO	Tray quantity / Liczba półek	Socket quantity / Liczba kieszeni	
YT-09092	2	4	1

EN Power tool cabinet
PL Szafka na elektronarzędzia
DE Elektrowerkzeug-Wandschrank
RU Шкаф настенный для электроинструмента
CZ Skříňka na elektrické nářadí
HU Elektromos szerszámtartó szekrény

RO Dulap pt. scule electrice
FR Armoire pour outils électriques
IT Armadietto per elettrotrattensili
ES Armario para herramientas eléctricas
CN 电动工具柜

480x430
x280
mm

x4



2x



YATO	Socket quantity / Liczba kieszeni	
YT-09093	4	1







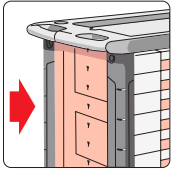







EN Service tool cabinet with tools
 PL Szafka serwisowa z narzędziami
 DE Werkstattwagen mit Werkzeug
 RU Сервисный шкаф с инструментами
 CZ Vozík servisní s nářadím
 HU Szerszámkocsi szerszámokkal

RO Dulap echipat cu scule
 FR Servante d'atelier complète
 IT Armadio da officina con attrezzi
 ES Carro taller con herramientas
 CN 维修工具柜





157 PCS	977x725 x480 mm	7x	BALL BEARINGS KOZYSKA KULKOWE	CENTRAL LOCK BLOKADA CENTRALNA	OIL PROOF STEEL WORKTOP OLEOOPORNY STALOWY BLAT
3 TRAYS TACE	EVA	∅120mm	2x BRAKE HAMULEC	UNIVERSAL PERFORATION UNIVERSALNA PERFORACJA	CORNER BUMPERS NAROZNE ODBOJNIKI
					2x















Drawer 1 / Szufiada 1

-  1/2" (12.7 mm): 8, 9, 10, 11, 12, 13, 14, 15, 16, 17, 18, 19, 20, 21, 22, 24 (L=38 mm); 27, 30, 32 mm (L=42 mm), 1/4" (6.3 mm): 4, 4.5, 5, 5.5, 6, 7, 8, 9, 10, 11, 12, 13 (L=25 mm); CrV 50BV30;
-  1/2" (12.7 mm): 10, 13, 14, 15, 17, 19, 21 mm (L=76 mm), 1/4" (6.3 mm): 6, 7, 8, 9, 10, 11, 12, 13 (L=50 mm); CrV 50BV30;
-  1/2" (12.7 mm): E10, E11, E12, E14, E16, 1/4" (6.3 mm): E4, E5, E6, E7, E8; CrV 50BV30;
-  1/2" (12.7 mm): (127, 254 mm), 1/4" (6.3 mm): (50.8, 101.6 mm); CrV 50BV30;
-  1/2" (12.7 mm); CrV 50BV30;
-  1/2" (12.7 mm): 16, 21 mm; CrV 50BV30;
-  1/2" (12.7 mm); (255 mm), 1/4" (6.3 mm): (152.4 mm); CrV 50BV30;
-  1/2" (12.7 mm); (255 mm), 1/4" (6.3 mm): (155 mm); CrV 6140;
-  1/4" (6.3 mm); (150 mm); CrV 50BV30;
-  1/4" (6.3 mm): 4, 5.5, 6.5 mm; AISI S2 / CrV 6150;
-  1/4" (6.3 mm): PH1 (x2), PH2 (x2), PH3; AISI S2 / CrV 6150;
-  1/4" (6.3 mm): PZ1, PZ2, PZ3; AISI S2 / CrV 6150;
-  1/4" (6.3 mm): T8, T10, T15, T20, T25, T30, T40; AISI S2 / CrV 6150;
-  1/4" (6.3 mm): 3, 4, 5, 6, 7, 8 mm; AISI S2 / CrV 6150

Drawer 2 / Szufiada 2

-  ∅ 3-6 mm (L=52 mm), ∅ 6-8 (L=58 mm), ∅ 8-11 (L=66 mm), ∅ 11-14 (L=75 mm), ∅ 14-18 (L=80 mm), ∅ 18-25 (L=88 mm);
-  8, 9, 10, 11, 12, 13, 14, 15, 16, 17, 18, 19, 21, 22, 24 mm; CrV;
-  200 mm; CrV;
-  T10, T15, T20, T25, T27, T30, T40, T45, T50; CrV 6150;
-  2, 2.5, 3, 4, 5, 6, 7, 8, 10, 12 mm; CrV 6150

Drawer 3 / Szufiada 3

-  6x100 mm; CrV 6150; PH2x100 mm; CrV 6150;
-  6x38, 3x75 mm; S2; PH0x75, PH2x38 mm; S2;
-  180 mm; CrV 50;
-  160 mm; CrV 50;
-  160 mm; CrV 6150;
-  150 mm;
-  180 mm; CrMo;
-  180 mm; CrV 50;
-  180 mm; CrV 50;
-  180 mm; CrV 50;
-  180 mm; CrV 50;
-  1.5, 2, 2.5, 3, 4, 5, 6, 8, 10 mm; CrV 6150

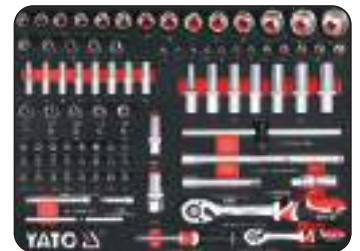

EN Service tool cabinet with tools
PL Szafka serwisowa z narzędziami
DE Werkstattwagen mit Werkzeug
RU Сервисный шкаф с инструментами
CZ Vozík servisní s nářadím
HU Szerszámkocsi szerszámokkal

RO Dulap echipat cu scule
FR Servante d'atelier complète
IT Armadio da officina con attrezzi
ES Carro taller con herramientas
CN 维修工具柜

165
PCS

958x766
x465
mm

7x

BALL BEARINGS
ŁOŻYSKA
KULKOWE

DRAWERS
LOCKING
BLOKADA
SZUFLAD

CENTRAL
LOCK
BLOKADA
CENTRALNA

NON SLIP
WORKTOP
BLAT ANTY-
POŚLIZGOWY

∅125mm

UNIVERSAL
PERFORATION
UNIWERSALNA
PERFORACJA

DOUBLE
WALLS
PODWOJNE
SCIANY

CORNER
BUMBERS
NAROZNE
ODBOJNIKI

3x

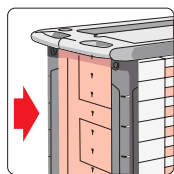

Drawer 1 / Szufiada 1

- 1/2" (12.7 mm), 3/8" (9.5 mm);
- T20, T25, T30, T40, T45, T50, T55 (L=30 mm);
- T20, T25, T30, T40, T45, T50, T55 (L=75 mm); AISI S2;
- 4, 5, 6, 7, 8, 10, 12 mm (L=30 mm); 4, 5, 6, 7, 8, 10, 12 mm (L=75 mm); AISI S2;
- M5, M6, M8, M10, M12 (L=30 mm); M5, M6, M8, M10, M12 (L=75 mm); AISI S2;
- 6, 7, 8, 9, 10, 11, 12, 13, 14, 15, 16, 17, 18, 19, 20, 21 mm; CrV;
- 22, 24, 27, 28, 30, 32 mm; CrV

Drawer 2 / Szufiada 2

- 1/2" (12.7 mm): 10, 11, 12, 13, 14, 15, 16, 17, 18, 19, 20, 21, 22, 23, 24, 27, 30, 32 mm; CrV 50BV30;
- 1/2" (12.7 mm); (127 mm); CrV 50BV30;
- 1/2" (12.7 mm); CrV 50BV30;
- 1/2" (12.7 mm): 16; 21 mm; CrV 50BV30;
- 1/2" (12.7 mm); (255 mm); CrV 50BV30;
- 1/2" (12.7 mm); (255 mm); 72T; CrV 6140;
- 1/4" (6.3 mm): 3.5, 4, 4.5, 5, 5.5, 6, 7, 8, 9, 10, 11, 12, 13, 14 mm; CrV 50BV30;
- 1/4" (6.3 mm): 8, 10, 11, 12, 13 mm; CrV 50BV30;
- 1/4" (6.3 mm); (50.8, 101.6 mm); CrV 6140;
- 1/4" (6.3 mm); CrV 50BV30;
- 1/4" (6.3 mm); (152.4 mm); CrV 50BV30;
- 1/4" (6.3 mm); (155 mm); 72T; CrV 6140;
- 1/4" (6.3 mm); (150 mm); CrV 50BV30;
- 180 mm;
- 160 mm;
- 160 mm long nose;
- 160 mm bent nose

Drawer 3 / Szufiada 3

- 3x75, 5x100, 5x150, 6x38, 6x100, 6x150, 8x150 mm; CrMo;
- PH0x100, PH1x75, PH1x100, PH2x38, PH2x100, PH2x150, PH3x150 mm; CrMo;
- 180, 250 mm;
- 280 mm

Drawer 4 / Szufiada 4

- 3/4" (19.0 mm): 21, 22, 24, 27, 28, 29, 30, 32, 34, 36, 41, 46, 50, 55 mm; CrV 50BV30;
- 3/4" (19.0 mm); (200 mm); CrV 6140;
- 3/4" (19.0 mm); CrV 50BV30;
- 3/4" (19.0 mm); (500 mm); 72T; CrV 6140;
- 3/4" (19.0 mm); (500 mm); CrV 50BV30

Drawer 5 / Szufiada 5

- 1/2" (12.7 mm) x 5/16" (7.9 mm);
- 8 mm (L=35 mm); 8 mm (L=75 mm);
- PH3 (L=35 mm); PH1, PH2, PH3 (L=75 mm);
- 12-38 mm;
- 3" (75 mm);
- 82 mm;
- 200 mm;
- 135 mm;
- 300, 400, 500 mm

13 interchangeable trays with YATO tools
13 wymiennych modułów z narzędziami YATO



YATO

Drawer quantity / Liczba szuflad

YT-55293

7

1

EN Service tool cabinet with tools
 PL Szafka serwisowa z narzędziami
 DE Werkstattwagen mit Werkzeug
 RU Сервисный шкаф с инструментами
 CZ Vozík servisní s nářadím
 HU Szerszámkocsi szerszámokkal

RO Dulap echipat cu scule
 FR Servante d'atelier complète
 IT Armadio da officina con attrezzi
 ES Carro taller con herramientas
 CN 维修工具柜

177 PCS	970x770 x470 mm	6x	BALL BEARINGS ŁOŻYSKA KULKOWE	DRAWERS LOCKING BLOKADA SZUFLAD	NON SLIP WORKTOP BLAT ANTY- POŚLĘGOWY
∅125mm	UNIVERSAL PERFORATION UNIVERSALNA PERFORACJA	DOUBLE WALLS PODWÓJNE ŚCIANY	CORNER BUMPERS NAROZNE ODBOJNIKI	2x	
	BRAKE HAMULEC				

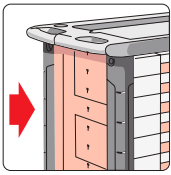

Drawer 1 / Szuflada 1

- 6, 7, 8, 9, 10, 11, 12, 13, 14, 15, 16, 17, 18, 19, 20, 21 mm; CrV;
- 22, 24, 27, 28, 30, 32 mm; CrV;
- 6x7, 8x9, 10x11, 12x13, 14x15, 16x17, 18x19 mm; CrV

Drawer 2 / Szuflada 2

- 3x75, 5x100, 5x150, 6x38, 6x100, 6x150, 8x150 mm; CrMo;
- PH0x100, PH1x75, PH1x100, PH2x38, PH2x100, PH2x150, PH3x150 mm; CrMo;
- 180 mm;
- 160 mm;
- 160 mm long nose;
- 160 mm bent nose

Drawer 3 / Szuflada 3

- 1/2" (12.7 mm): 10, 11, 12, 13, 14, 15, 16, 17, 18, 19, 20, 21, 22, 23, 24, 27, 30, 32 mm; CrV 50BV30;
- 1/2" (12.7 mm); (127 mm); CrV 50BV30;
- 1/2" (12.7 mm); CrV 50BV30;
- 1/2" (12.7 mm): 16; 21 mm; CrV 50BV30;
- 1/2" (12.7 mm); (255 mm); CrV 50BV30;
- 1/2" (12.7 mm); (255 mm); 72T; CrV 6140;
- T20, T25, T30, T40, T45, T50, T55 (L=30 mm); T20, T25, T30, T40, T45, T50, T55 (L=75 mm); AISI S2;
- 4, 5, 6, 7, 8, 10, 12 mm (L=30 mm); 4, 5, 6, 7, 8, 10, 12 mm (L=75 mm); AISI S2;
- M5, M6, M8, M10, M12 (L=30 mm); M5, M6, M8, M10, M12 (L=75 mm); AISI S2;
- 1/2" (12.7 mm), 3/8" (9.5 mm);
- 1/2" (12.7 mm): 8, 9, 10, 11, 12, 13, 14, 15, 16, 17, 18, 19, 20, 21 mm (L=76 mm); CrV 50BV30

Drawer 4 / Szuflada 4

- 300 g (L=300 mm);
- 40 mm (L=350 mm);
- 10x8x142 mm, 12x10x152 mm, 16x13x172 mm;
- 3/8" (9.5 mm): 6, 7, 8, 9, 10, 11, 12, 13, 14, 15, 16, 17, 18, 19, 20, 21, 22 mm; CrV 50BV30;
- 3/8" (9.5 mm); (76, 152.4 mm); CrV 50BV30;
- 3/8" (9.5 mm); CrV 50BV30;
- 3/8" (9.5 mm); (198 mm); CrV 50BV30;
- 3/8" (9.5 mm); (200 mm); 72T; CrV 6140;
- 1/4" (6.3 mm): 3.5, 4, 4.5, 5, 5.5, 6, 7, 8, 9, 10, 11, 12, 13, 14 mm; CrV 50BV30;
- 1/4" (6.3 mm): 8, 10, 11, 12, 13 mm; CrV 50BV30;
- 1/4" (6.3 mm); (50.8, 101.6 mm); CrV 6140;
- 1/4" (6.3 mm); CrV 50BV30;
- 1/4" (6.3 mm); (152.4 mm); CrV 50BV30;
- 1/4" (6.3 mm); (155 mm); 72T; CrV 6140;
- 1/4" (6.3 mm); (150 mm); CrV 50BV30

12 interchangeable trays with YATO tools
 12 wymiennych modułów z narzędziami YATO



YATO	Drawer quantity / Liczba szuflad	
YT-5530	6	1

EN Service tool cabinet with tools
PL Szafka serwisowa z narzędziami
DE Werkstattwagen mit Werkzeug
RU Сервисный шкаф с инструментами
CZ Vozík servisní s nářadím
HU Szerszámkocsi szerszámokkal

RO Dulap echipat cu scule
FR Servante d'atelier complète
IT Armadio da officina con attrezzi
ES Carro taller con herramientas
CN 维修工具柜

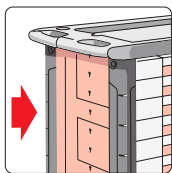

Drawer 1 / Szufłada 1

- 6, 7, 8, 9, 10, 11, 12, 13, 14, 15, 16, 17, 18, 19, 20, 21 mm; CrV;
- 22, 24, 27, 28, 30, 32 mm; CrV;
- 6x7, 8x9, 10x11, 12x13, 14x15, 16x17, 18x19 mm; CrV

Drawer 2 / Szufłada 2

- 3x75, 5x100, 5x150, 6x38, 6x100, 6x150, 8x150 mm; CrMo;
- PH0x100, PH1x75, PH1x100, PH2x38, PH2x100, PH2x150, PH3x150 mm; CrMo;
- 180 mm;
- 160 mm;
- 160 mm long nose;
- 160 mm bent nose

Drawer 3 / Szufłada 3

- 1/2" (12.7 mm): 10, 11, 12, 13, 14, 15, 16, 17, 18, 19, 20, 21, 22, 23, 24, 27, 30, 32 mm; CrV 50BV30;
- 1/2" (12.7 mm): (127 mm); CrV 50BV30;
- 1/2" (12.7 mm): CrV 50BV30;
- 1/2" (12.7 mm): 16, 21 mm; CrV 50BV30;
- 1/2" (12.7 mm): (255 mm); CrV 50BV30;
- 1/2" (12.7 mm): (255 mm); 72T; CrV 6140;
- T20, T25, T30, T40, T45, T50, T55 (L=30 mm); T20, T25, T30, T40, T45, T50, T55 (L=75 mm); AISI S2;
- 4, 5, 6, 7, 8, 10, 12 mm (L=30 mm); 4, 5, 6, 7, 8, 10, 12 mm (L=75 mm); AISI S2;
- M5, M6, M8, M10, M12 (L=30 mm); M5, M6, M8, M10, M12 (L=75 mm); AISI S2;
- 1/2" (12.7 mm), 3/8" (9.5 mm);
- 1/2" (12.7 mm): 8, 9, 10, 11, 12, 13, 14, 15, 16, 17, 18, 19, 20, 21 mm (L=76 mm); CrV 50BV30

Drawer 4 / Szufłada 4

- 300 g (L=300 mm);
- 40 mm (L=350 mm);
- 10x8x142 mm, 12x10x152 mm, 16x13x172 mm;
- 3/8" (9.5 mm): 6, 7, 8, 9, 10, 11, 12, 13, 14, 15, 16, 17, 18, 19, 20, 21, 22 mm; CrV 50BV30;
- 3/8" (9.5 mm): (76, 152.4 mm); CrV 50BV30;
- 3/8" (9.5 mm); CrV 50BV30;
- 3/8" (9.5 mm): (198 mm); CrV 50BV30;
- 3/8" (9.5 mm); (200 mm); 72T; CrV 6140;
- 1/4" (6.3 mm): 3.5, 4, 4.5, 5, 5.5, 6, 7, 8, 9, 10, 11, 12, 13, 14 mm; CrV 50BV30;
- 1/4" (6.3 mm): 8, 10, 11, 12, 13 mm; CrV 50BV30;
- 1/4" (6.3 mm): (50.8, 101.6 mm); CrV 6140;
- 1/4" (6.3 mm); CrV 50BV30;
- 1/4" (6.3 mm): (152.4 mm); CrV 50BV30;
- 1/4" (6.3 mm): (155 mm); 72T; CrV 6140;
- 1/4" (6.3 mm); (150 mm); CrV 50BV30

12 interchangeable trays with YATO tools
12 wymiennych modułów z narzędziami YATO



YATO	Drawer quantity / Liczba szuflad	
YT-55300	6	1

EN Service tool cabinet with tools
 PL Szafka serwisowa z narzędziami
 DE Werkstattwagen mit Werkzeug
 RU Сервисный шкаф с инструментами
 CZ Vozík servisní s nářadím
 HU Szerszámkocsi szerszámokkal

RO Dulap echipat cu scule
 FR Servante d'atelier complète
 IT Armadio da officina con attrezzi
 ES Carro taller con herramientas
 CN 维修工具柜

185
PCS

970x770
x470
mm

6x

BALL BEARINGS
ŁOŻYSKA
KULKOWE

DRAWERS
LOCKING
BLOKADA
SZUFLAD

NON SLIP
WORKTOP
BLAT ANTY-
POŚLIZGOWY

∅125 mm

CORNER
BUMPERS
NARÓŻNE
ODBOJNIKI

UNIVERSAL
PERFORATION
UNIWERSALNA
PERFORACJA

DOUBLE
WALLS
PODWÓJNE
SCIANY

2x

KEY

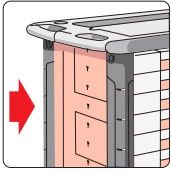

Drawer 1 / Szuflada 1

- 6, 7, 8, 9, 10, 11, 12, 13, 14, 15, 16, 17, 18, 19, 20, 21 mm; CrV;
- 22, 24, 27, 28, 30, 32 mm; CrV;
- 6x7, 8x9, 10x11, 12x13, 14x15, 16x17, 18x19 mm; CrV

Drawer 2 / Szuflada 2

- 3x75, 5x100, 5x150, 6x38, 6x100, 6x150, 8x150 mm; CrMo;
- PH0x100, PH1x75, PH1x100, PH2x38, PH2x100, PH2x150, PH3x150 mm; CrMo;
- 180 mm;
- 160 mm;
- 160 mm long nose;
- 160 mm bent nose

Drawer 3 / Szuflada 3

- 1/2" (12.7 mm): 10, 11, 12, 13, 14, 15, 16, 17, 18, 19, 20, 21, 22, 23, 24, 27, 30, 32 mm; CrV 50BV30;
- 1/2" (12.7 mm); (127 mm); CrV 50BV30;
- 1/2" (12.7 mm); CrV 50BV30;
- 1/2" (12.7 mm): 16, 21 mm; CrV 50BV30;
- 1/2" (12.7 mm); (255 mm); CrV 50BV30;
- 1/2" (12.7 mm); (255 mm); T2T; CrV 6140;
- T20, T25, T30, T40, T45, T50, T55 (L=30 mm); T20, T25, T30, T40, T45, T50, T55 (L=75 mm); AISI S2;
- 4, 5, 6, 7, 8, 10, 12 mm (L=30 mm); 4, 5, 6, 7, 8, 10, 12 mm (L=75 mm); AISI S2;
- M5, M6, M8, M10, M12 (L=30 mm); M5, M6, M8, M10, M12 (L=75 mm); AISI S2;
- 1/2" (12.7 mm); 3/8" (9.5 mm);
- 1/2" (12.7 mm): 8, 9, 10, 11, 12, 13, 14, 15, 16, 17, 18, 19, 20, 21 mm (L=76 mm); CrV 50BV30

Drawer 4 / Szuflada 4

- 300 g (L=300 mm);
- Ø 40 mm (L=350 mm);
- 10x8x142 mm, 12x10x152 mm, 16x13x170 mm;
- 1/4" (6.3 mm): 3.5, 4, 4.5, 5, 5.5, 6, 7, 8, 9, 10, 11, 12, 13, 14 mm; CrV 50BV30;
- 1/4" (6.3 mm): 8, 10, 11, 12, 13 mm; CrV 50BV30;
- 1/4" (6.3 mm); (50.8, 101.6 mm); CrV 6140;
- 1/4" (6.3 mm); CrV 50BV30;
- 1/4" (6.3 mm); (152.4 mm); CrV 50BV30;
- 1/4" (6.3 mm); (155 mm); T2T; CrV 6140;
- 1/4" (6.3 mm); (150 mm); CrV 50BV30;
- 1/2" (12.5 mm): E10, E12, E14, E16, E18, E20;
- 1/4" (6.3 mm): E4, E5, E6, E7, E8;
- 2, 2.5, 3, 4, 5, 6, 7, 8, 10, 12 mm;
- T10, T15, T20, T25, T27, T30, T40, T45, T50

12 interchangeable trays with YATO tools
 12 wymiennych modułów z narzędziami YATO



YATO
YT-55307

Drawer quantity / Liczba szuflad

6

1

EN Service tool cabinet with tools
PL Szafka serwisowa z narzędziami
DE Werkstattwagen mit Werkzeug
RU Сервисный шкаф с инструментами
CZ Vozík servisní s nářadím
HU Szerszámköcsi szerszámokkal

RO Dulap echipat cu scule
FR Servante d'atelier complète
IT Armadio da officina con attrezzi
ES Carro taller con herramientas
CN 维修工具柜

211
PCS

980x770
x465
mm

7x

BALL
BEARINGS
ŁOŻYSKA
KULKOWE

DRAWERS
LOCKING
BLOKADA
SZUFLAD

NON SLIP
WORKTOP
BLAT ANTI-
POŚLĘGOWY

∅125mm

CORNER
BUMPER
NAROŻNE
ODBOJNIKI

BRAKE
HAMULEC

UNIVERSAL
PERFORATION
UNIWERSALNA
PERFORACJA

DOUBLE
WALLS
PODWÓJNE
SCIANY

3x

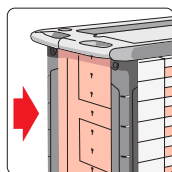

Drawer 1 / Szuflada 1

- 1/2" (12.7 mm): 8, 9, 10, 11, 12, 13, 14, 15, 16, 17, 18, 19, 20, 21, 22, 24 mm (L=38 mm); 27, 30, 32 mm (L=42 mm), 1/4" (6.3 mm): 4, 4.5, 5, 5.5, 6, 7, 8, 9, 10, 11, 12, 13 mm (L=25 mm); CrV 50BV30;
- 1/2" (12.7 mm): 10, 13, 14, 15, 17, 19, 21 mm (L=76 mm), 1/4" (6.3 mm): 6, 7, 8, 9, 10, 11, 12, 13 mm (L=50 mm); CrV 50BV30;
- 1/2" (12.7 mm): E10, E11, E12, E14, E16, 1/4" (6.3 mm): E4, E5, E6, E7, E8; CrV 50BV30;
- 1/2" (12.7 mm): (127, 254 mm), 1/4" (6.3 mm): (50.8, 101.6 mm); CrV 50BV30;
- 1/2" (12.7 mm): CrV 50BV30;
- 1/2" (12.7 mm): 16, 21 mm; CrV 50BV30;
- 1/2" (12.7 mm): (255 mm), 1/4" (6.3 mm): (152.4 mm); CrV 50BV30;
- 1/2" (12.7 mm): (255 mm), 1/4" (6.3 mm): (155 mm); CrV 6140;
- 1/4" (6.3 mm): (150 mm); CrV 50BV30;
- 1/4" (6.3 mm): 4, 5.5, 6.5 mm; AISI S2 / CrV 6150;
- 1/4" (6.3 mm): PH1 x2, PH2 x2, PH3; AISI S2 / CrV 6150;
- 1/4" (6.3 mm): PZ1, PZ2, PZ3; AISI S2 / CrV 6150;
- 1/4" (6.3 mm): T8, T10, T15, T20, T25, T30, T40; AISI S2 / CrV 6150;
- 1/4" (6.3 mm): 3, 4, 5, 6, 7, 8 mm; AISI S2 / CrV 6150

Drawer 2 / Szuflada 2

- 200 mm; CrV;
- ∅ 3-6 mm (L=52 mm), ∅ 6-8 mm (L=58 mm), ∅ 8-11 mm (L=66 mm), ∅ 11-14 mm (L=75 mm), ∅ 14-18 mm (L=80 mm), ∅ 18-25 mm (L=88 mm);
- 8, 9, 10, 11, 12, 13, 14, 15, 16, 17, 18, 19, 21, 22, 24 mm; CrV;
- T10, T15, T20, T25, T27, T30, T40, T45, T50; CrV 6150;
- 2, 2.5, 3, 4, 5, 6, 7, 8, 10, 12 mm; CrV 6150

Drawer 3 / Szuflada 3

- 6x38, 2x75, 3x75, 4x100, 5x100, 6x100 mm; PH0x100, PH1x100, PH2x38, PH2x150, PH3x150 mm;
- T7x75, T8x75, T9x75, T10x100, T15x100, T20x100, T25x100, T27x100 mm; S2;
- 6.0x150 mm; PH2x150 mm; CrV 6150

Drawer 4 / Szuflada 4

- 180 mm;
- 160 mm;
- 200 mm;
- 250 mm;
- 400 g;
- 340 g;
- 12.5x152, 16.0x172 mm; CrV 6150;
- 3x150, 4x150, 5x150, 6x150, 8x150 mm; CrV 6150;
- 8x112 mm; CrV 6150

Drawer 5 / Szuflada 5

- M3x0.5 x3, M4x0.7 x3, M5x0.8 x3, M6x1.0 x3, M7x1.0 x3, M8x1.25 x3, M10x1.5 x3, M12x1.75 x3; HSS M2;
- M3, M4x0.7, M5x0.8, M6x1.0, M7x1.0, M8x1.25, M10x1.5, M12x1.75; HSS M2;
- M7-M9;
- M3-M12;
- #2, 200 mm;
- #2, 200 mm;
- #2, 200 mm;
- LED;
- 3 m x 16 mm;
- 300 mm;
- 0-150 mm



YATO	Drawer quantity / Liczba szuflad	
YT-55290	7	1

CREATE YOUR WORKPLACE - STWÓRZ SWOJE MIEJSCE PRACY

YT-09061



YT-09152



YT-08922



YT-08921



YT-08920

- EN Tool chest
- PL Szafka warsztatowa
- DE Werkzeugkasten
- RU Портативный ящик для инструментов
- CZ Přenosná skříňka na nářadí
- HU Hordozható szerszámcs láda
- RO Cabinet pt. scule
- FR Servante d'atelier
- IT Armadio con casetti per officina
- ES Cajonera portátil
- CN 工具柜

690x465 x400 mm	4x	UNIVERSAL PERFORATION UNIVERSALNA PERFORACJA	DOUBLE WALLS PODWÓJNE ŚCIANY	CORNER BUMPERS NARÓŻNE ODBOJNIKI	DRAWERS LOCKING BLOKADA SZUFLAD	CENTRAL LOCK BLOKADA CENTRALNA	NON SLIP WORKTOP BLAT ANTY-POSLIZGOWY
					2x		



- EN Tool chest
- PL Szafka warsztatowa
- DE Werkzeugkasten
- RU Портативный ящик для инструментов
- CZ Přenosná skříňka na nářadí
- HU Hordozható szerszámcs láda
- RO Cabinet pt. scule
- FR Servante d'atelier
- IT Armadio con casetti per officina
- ES Cajonera portátil
- CN 工具柜

690x465 x535 mm	6x	UNIVERSAL PERFORATION UNIVERSALNA PERFORACJA	DOUBLE WALLS PODWÓJNE ŚCIANY	CORNER BUMPERS NARÓŻNE ODBOJNIKI	DRAWERS LOCKING BLOKADA SZUFLAD	CENTRAL LOCK BLOKADA CENTRALNA	NON SLIP WORKTOP BLAT ANTY-POSLIZGOWY
					2x		

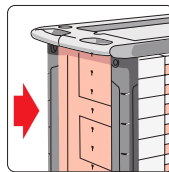
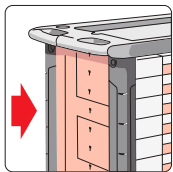

YATO	Drawer quantity / Liczba szuflad	
YT-09152	4	1

YATO	Drawer quantity / Liczba szuflad	
YT-09155	6	1

- EN Roller cabinet
- PL Szafka serwisowa
- DE Werkstattrollwagen
- RU Инструментальный кабинет
- CZ Dilenská skříňka
- HU Szerszámcs kocsi
- RO Dulap de scule
- FR Servante d'atelier
- IT Armadio da officina per attrezzi
- ES Armario en ruedas
- CN 高档6抽屉边柜工具车

1000x1130 x570 mm	6+1	BALL BEARINGS ŁOŻYSKA KULKOWE	DOUBLE WALLS PODWÓJNE ŚCIANY	CORNER BUMPERS NARÓŻNE ODBOJNIKI	DRAWERS LOCKING BLOKADA SZUFLAD	OIL PROOF STEEL WORKTOP OLEODOPORNY STALOWY BLAT	Ø160mm
		BRAKE HAMULEC			2x		

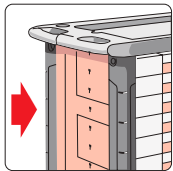

YATO	Drawer quantity / Liczba szuflad	
YT-09002	6+1	1

- EN Roller cabinet
- PL Szafka serwisowa
- DE Werkstattrollwagen
- RU Инструментальный кабинет
- CZ Dilenská skříňka
- HU Szerszámcs kocsi
- RO Dulap de scule
- FR Servante d'atelier
- IT Armadio da officina per attrezzi
- ES Armario en ruedas
- CN 高档12抽屉工具车

1000x1130 x570 mm	12x	BALL BEARINGS ŁOŻYSKA KULKOWE	DOUBLE WALLS PODWÓJNE ŚCIANY	CORNER BUMPERS NARÓŻNE ODBOJNIKI	DRAWERS LOCKING BLOKADA SZUFLAD	OIL PROOF STEEL WORKTOP OLEODOPORNY STALOWY BLAT	Ø160mm
		BRAKE HAMULEC			2x		

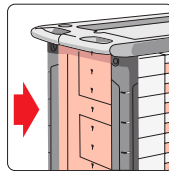

YATO	Drawer quantity / Liczba szuflad	
YT-09003	12	1

EN Roller cabinet
PL Szafka serwisowa
DE Werkstattrollwagen
RU Инструментальный кабинет
CZ Dílenská skříňka
HU Szerszámokocsi
RO Dulap de scule
FR Servante d'atelier
IT Armadio da officina per attrezzi
ES Armario en ruedas
CN 工具车



YATO	Drawer quantity / Liczba szuflad	
YT-09004	7	1

EN Roller cabinet
PL Szafka serwisowa
DE Werkstattrollwagen
RU Инструментальный кабинет
CZ Dílenská skříňka
HU Szerszámokocsi
RO Dulap de scule
FR Servante d'atelier
IT Armadio da officina per attrezzi
ES Armario en ruedas
CN 工具车



YATO	Drawer quantity / Liczba szuflad	
YT-09033	7+1	1

EN Roller cabinet
PL Szafka serwisowa
DE Werkstattrollwagen
RU Инструментальный кабинет
CZ Dílenská skříňka
HU Szerszámokocsi
RO Dulap de scule
FR Servante d'atelier
IT Armadio da officina per attrezzi
ES Armario en ruedas
CN 工具车



YATO	Drawer quantity / Liczba szuflad	
YT-09032	7	1

EN Roller cabinet
PL Szafka serwisowa
DE Werkstattrollwagen
RU Инструментальный кабинет
CZ Dílenská skříňka
HU Szerszámokocsi
RO Dulap de scule
FR Servante d'atelier
IT Armadio da officina per attrezzi
ES Armario en ruedas
CN 工具车





YATO	Drawer quantity / Liczba szuflad	
YT-0913	6	1

EN Roller cabinet
 PL Szafka serwisowa
 DE Werkstattrollwagen
 RU Инструментальный кабинет
 CZ Dilenská skříňka
 HU Szerszámos kocsí
 RO Dulap de scule
 FR Servante d'atelier
 IT Armadio da officina per attrezzi
 ES Armario en ruedas
 CN 工具车







995x680 x458 mm	 7x	BALL BEARINGS ŁOŻYSKA KULKOWE	max  300kg	DRAWERS LOCKING BLOKADA SZUFLAD
CENTRAL LOCK BLOKADA CENTRALNA	NON SLIP WORKTOP BLAT ANTY- POŚLIZGOWY	∅127mm	2x  BRAKE HAMULEC	2x 
				

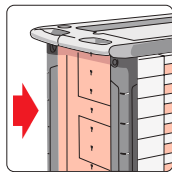



YATO 	Drawer quantity / Liczba szuflad	
YT-0914	7	1

EN Roller cabinet
 PL Szafka serwisowa
 DE Werkstattrollwagen
 RU Инструментальный кабинет
 CZ Dilenská skříňka
 HU Szerszámos kocsí
 RO Dulap de scule
 FR Servante d'atelier
 IT Armadio da officina per attrezzi
 ES Armario en ruedas
 CN 工具车









975x765 x465 mm	 6x	BALL BEARINGS ŁOŻYSKA KULKOWE	 250kg	CENTRAL LOCK BLOKADA CENTRALNA
DRAWERS LOCKING BLOKADA SZUFLAD	NON SLIP WORKTOP BLAT ANTY- POŚLIZGOWY	∅125mm	2x  BRAKE HAMULEC	NON SLIP WORKTOP BLAT ANTY- POŚLIZGOWY
UNIVERSAL PERFORATION UNIVERSALNA PERFORACJA	DOUBLE WALLS PODWOJNE SCIANY	CORNER BUMPERS NARÓŻNE ODBOJNIKI	2x 	
				

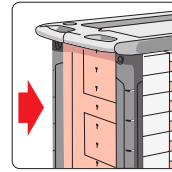



YATO 	Drawer quantity / Liczba szuflad	
YT-55299	6	1

EN Roller cabinet
 PL Szafka serwisowa
 DE Werkstattrollwagen
 RU Инструментальный кабинет
 CZ Dilenská skříňka
 HU Szerszámos kocsí
 RO Dulap de scule
 FR Servante d'atelier
 IT Armadio da officina per attrezzi
 ES Armario en ruedas
 CN 工具车



958x766 x465 mm	 6x	BALL BEARINGS ŁOŻYSKA KULKOWE	 250kg	CENTRAL LOCK BLOKADA CENTRALNA
DRAWERS LOCKING BLOKADA SZUFLAD	NON SLIP WORKTOP BLAT ANTY- POŚLIZGOWY	∅125mm	2x  BRAKE HAMULEC	NON SLIP WORKTOP BLAT ANTY- POŚLIZGOWY
UNIVERSAL PERFORATION UNIVERSALNA PERFORACJA	DOUBLE WALLS PODWOJNE SCIANY	CORNER BUMPERS NARÓŻNE ODBOJNIKI	2x 	
				



YATO 	Drawer quantity / Liczba szuflad	
YT-0902	6	1

EN Roller cabinet
 PL Szafka serwisowa
 DE Werkstattrollwagen
 RU Инструментальный кабинет
 CZ Dilenská skříňka
 HU Szerszámos kocsí
 RO Dulap de scule
 FR Servante d'atelier
 IT Armadio da officina per attrezzi
 ES Armario en ruedas
 CN 工具车

944x665 x453 mm	 7x	BALL BEARINGS ŁOŻYSKA KULKOWE	 250kg	CENTRAL LOCK BLOKADA CENTRALNA
DRAWERS LOCKING BLOKADA SZUFLAD	NON SLIP WORKTOP BLAT ANTY- POŚLIZGOWY	∅111mm	2x  BRAKE HAMULEC	NON SLIP WORKTOP BLAT ANTY- POŚLIZGOWY
UNIVERSAL PERFORATION UNIVERSALNA PERFORACJA	DOUBLE WALLS PODWOJNE SCIANY	CORNER BUMPERS NARÓŻNE ODBOJNIKI	2x 	
				



YATO 	Drawer quantity / Liczba szuflad	
YT-09000	7	1

EN Workshop trolley
PL Wózek warsztatowy
DE Werkstatt-Servicewagen
RU Инструментальная тележка
CZ Dílenský policový vozík
HU Műhelykocsi
RO Carucior pt. atelier
FR Chariot d'atelier
IT Carrello da officina
ES Carro para taller
CN 三层工具车



YATO Tray quantity / Liczba pólek
YT-55210 3 1

EN Shutter cabinet
PL Szafka wisząca
DE Werkstatt Hängeschrank
RU Шкафик для инструмента настенный
CZ Zavěsná skříňka
HU Szerszámtároló
RO Raft de scule
FR Placard d'atelier
IT Scaffale
ES Armario colgante
CN 卷帘柜



YATO Dimensions / Wymiary [mm]
YT-09061 1500x605x185 1

EN Drawer insert / Combination spanners
PL Wkład do szuflady / Klucze płasko-oczkowe
DE Schubladeneinlage / Schrauben- und Ringschlüssel
RU Вклад к выдвижному ящику / Плоско-закрытый накладной ключ
CZ Vložka do zásuvky / Klíče ploché-očkové
HU Fiókbetét / Csillag - villás kulcsok
RO Adaos la sertar / Chei plane - inelare
FR Module plastique pour servante avec clés mixtes
IT Tenone per l'armadio chiavi
ES Accesorio de cajón / Llave española de muletilla
CN 两用扳手托盘组套



22, 24, 27, 28, 30, 32 mm; CrV

YATO
YT-5532 4

EN Workshop trolley
PL Wózek warsztatowy
DE Werkstatt-Servicewagen
RU Инструментальная тележка
CZ Dílenský policový vozík
HU Műhelykocsi
RO Carucior pt. atelier
FR Chariot d'atelier
IT Carrello da officina
ES Carro para taller
CN 三层工具车



YATO Tray quantity / Liczba pólek
YT-55212 3 1

EN Workbench
PL Stół warsztatowy
DE Werkbank
RU Вертстак
CZ Pracovní stůl
HU Munkapad
RO Banc de lucru
FR Table d'atelier
IT Banco da lavoro
ES Banco de trabajo
CN 工作台



YATO Dimensions / Wymiary [mm]
YT-08920 1500x780x830 1

EN Drawer insert / Bi-hexagonal ring spanner
PL Wkład do szuflady / Klucze oczkowe odgięte
DE Schubladeneinlage / Doppelringschlüssel
RU Вклад к выдвижному ящику / Ключ накидной изогнутый
CZ Vložka do zásuvky / Klíče očkové ohnuté
HU Fiókbetét / Hajlítottszerű csillagkulcs
RO Adaos la sertar / Chei inelaro-curbata
FR Module plastique pour servante clés contre-coudées
IT Tenone per l'armadio chiavi
ES Accesorio de cajón / Llave de estrella
CN 双头高颈梅花扳手托盘组套



21x23, 24x27, 25x28, 30x32 mm; CrV

YATO
YT-5543 8

EN Drawer insert / Combination spanners
 PL Wkład do szuflady / Klucze płasko-oczkowe
 DE Schubladeneinlage / Schrauben- und Ringschlüssel
 RU Вклад к выдвижному ящику / Плоско-закрытый накладной ключ
 CZ Vložka do zásuvky / Klíče ploché-očkové
 HU Fiókbetét / Csillag - villás kulcsok
 RO Adaos la sertar / Chei plane - inelare
 FR Module plastique pour servante avec clés mixtes
 IT Tenone per l'armadio chiavi
 ES Accesorio de cajón / Llave española de muletilla
 CN 两用扳手托盘组套

16 PCS CrV



6, 7, 8, 9, 10, 11, 12, 13, 14, 15, 16, 17, 18, 19, 20, 21 mm; CrV

YATO YT-5531 8

EN Drawer insert / Bi-hexagonal ring spanner
 PL Wkład do szuflady / Klucze oczkowe odgięte
 DE Schubladeneinlage / Doppelringschlüssel
 RU Вклад к выдвижному ящику / Ключ накидной изогнутый
 CZ Vložka do zásuvky / Klíče očkové ohnuté
 HU Fiókbetét / Hajlítottzárú csillagkulcs
 RO Adaos la sertar / Chei inelaro-curbată
 FR Module plastique pour servante clés contre-coudées
 IT Tenone per l'armadio chiavi
 ES Accesorio de cajón / Llave de estrella
 CN 双头高颈梅花扳手托盘组套

7 PCS CrV



6x7, 8x9, 10x11, 12x13, 14x15, 16x17, 18x19 mm; CrV

YATO YT-5533 8

EN Drawer insert / L-type socket wrench
 PL Wkład do szuflady / Klucz nasadowy typ „L”
 DE Schubladeneinlage / Steckschlüssel gebogen
 RU Вклад к выдвижному ящику / Ключ торцевой L-типа
 CZ Vložka do zásuvky / Nástrčný klíč fajtkový
 HU Fiókbetét / Kulcs, dugó-pipa
 RO Adaos la sertar / Cheie tubulara cu cot tip „L”
 FR Module plastique pour servante / Clé a douille de type „L”
 IT Tenone per l'armadio / Chiave a tubo tipo „L”
 ES Accesorio de cajón / Llave de vaso „L”
 CN 套筒托盘工具组套

10 PCS CrV



7, 8, 9, 10, 11, 12, 13, 14, 17, 19 mm; CrV

YATO YT-55456 4

EN Drawer insert / Pliers
 PL Wkład do szuflady / Szczypce
 DE Schubladeneinlage / Zangen
 RU Вклад к выдвижному ящику / Клещи
 CZ Vložka do zásuvky / Kleště
 HU Fiókbetét / Fogó készlet
 RO Adaos la sertar / Clește
 FR Module plastique pour servante avec pinces
 IT Tenone per l'armadio / Pinze
 ES Accesorio de cajón / Pinzas
 CN 钳子托盘组套

4 PCS CrV



180 mm; CrV;
 160 mm; CrV;
 160 mm long nose; CrV;
 160 mm bent nose; CrV

YATO YT-5534 8

EN Drawer insert / Pliers
 PL Wkład do szuflady / Szczypce
 DE Schubladeneinlage / Zangen
 RU Вклад к выдвижному ящику / Клещи
 CZ Vložka do zásuvky / Kleště
 HU Fiókbetét / Zégerfogó készlet
 RO Adaos la sertar / Clește
 FR Module plastique pour servante avec pinces
 IT Tenone per l'armadio / Pinze
 ES Accesorio de cajón / Pinzas
 CN 卡簧钳托盘组套

4 PCS CrV



180 mm; external straight; CrV;
 180 mm; internal straight; CrV;
 180 mm; external bent; CrV;
 180 mm; internal bent; CrV

YATO YT-55443 8

EN Drawer insert / Pliers
 PL Wkład do szuflady / Szczypce
 DE Schubladeneinlage / Zangen
 RU Вклад к выдвижному ящику / Клещи
 CZ Vložka do zásuvky / Kleště
 HU Fiókbetét / Fogók
 RO Adaos la sertar / Clește
 FR Module plastique pour servante avec pinces
 IT Tenone per l'armadio / Pinze
 ES Accesorio de cajón / Pinzas
 CN 钳子托盘组套

3 PCS CrMo CrV



180 mm;
 250 mm; CrMo;
 250 mm; CrV

YATO YT-55463 8

EN Drawer insert / Pliers
 PL Wkład do szuflady / Szczypce
 DE Schubladeneinlage / Zangen
 RU Вклад к выдвижному ящику / Клещи
 CZ Vložka do zásuvky / Kleště
 HU Fiókbetét / Fogók
 RO Adaos la sertar / Clește
 FR Module plastique pour servante avec pinces
 IT Tenone per l'armadio / Pinze
 ES Accesorio de cajón / Pinzas
 CN 大力钳托盘组套

3 PCS CrMo CrV



180, 250 mm; CrMo;
 280 mm; CrV

YATO YT-55472 8

EN Drawer insert / Pliers
 PL Wkład do szuflady / Szczypce
 DE Schubladeneinlage / Zangen
 RU Вклад к выдвижному ящику / Клещи
 CZ Vložka do zásuvky / Kleště
 HU Fiókbetét / Fogók
 RO Adaos la sertar / Clește
 FR Module plastique pour servante avec pinces
 IT Tenone per l'armadio / Pinze
 ES Accesorio de cajón / Pinzas
 CN 钳子托盘组套

3 PCS CrMo CrV



250 mm; CrV;
 125 mm; CrMo;
 300 mm; CrV

YATO YT-55473 8

EN Drawer insert / Tool set for plumbers
PL Wkład do szuflady / Zestaw narzędziowy dla hydraulików
DE Schubladeneinlage / Werkzeug-Set für Klempner
RU Вклад к выдвижному ящику / Набор инструментов для водопроводчик
CZ Vložka do zásuvky / Sada nářadí pro instalatér
HU Fiókbetét / Szerszámkészlet vízvezeték-szerelő
RO Adaos la sertar / Set de instrumente pt. instalator
FR Module plastique pour servante / Ensemble d'outils pour les plombier
IT Tenone per l'armadio / Tool set per idraulici
ES Accesorio de cajón / Conjunto de herramientas para fontanero
CN 管道工具组套

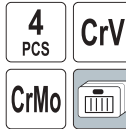

250 mm; CrV;
330 mm; CrV 6140;
250 mm; CrMo;
15 m x 19 mm; PTFE



YATO
YT-55480

5

EN Drawer insert / Tool set for plumbers
PL Wkład do szuflady / Zestaw narzędziowy dla hydraulików
DE Schubladeneinlage / Werkzeug-Set für Klempner
RU Вклад к выдвижному ящику / Набор инструментов для водопроводчик
CZ Vložka do zásuvky / Sada nářadí pro instalatér
HU Fiókbetét / Szerszámkészlet vízvezeték-szerelő
RO Adaos la sertar / Set de instrumente pt. instalator
FR Module plastique pour servante / Ensemble d'outils pour les plombier
IT Tenone per l'armadio / Tool set per idraulici
ES Accesorio de cajón / Conjunto de herramientas para fontanero
CN 管道工具组套



250 mm;
300 mm;
250 mm; CrV;
3-32 mm;
10 m x 12 mm; PTFE



YATO
YT-55481

5

EN Drawer insert / Pliers and adjustable wrenches
PL Wkład do szuflady / Szczypce i klucze nastawne
DE Schubladeneinlage / Zangen und rollgabelschlüssel
RU Вклад к выдвижному ящику / Клещи и ключ разводной
CZ Vložka do zásuvky / Kleště, nastavitelný klíč
HU Fiókbetét / Fogók és állítható svédkulcs
RO Adaos la sertar / Clește și cheie reglabilă
FR Module plastique pour servante / Pincés et clé a molette
IT Tenone per l'armadio / Pinze
ES Accesorio de cajón / Pinzas y llave ajustable
CN 活扳手及大力钳托盘组套



200, 250 mm;
250 mm; CrMo;
150 mm; CrMo



YATO
YT-55444

8

EN Drawer insert / Pliers
PL Wkład do szuflady / Szczypce
DE Schubladeneinlage / Zangen
RU Вклад к выдвижному ящику / Клещи
CZ Vložka do zásuvky / Kleště
HU Fiókbetét / Fogók
RO Adaos la sertar / Clește
FR Module plastique pour servante avec pincés
IT Tenone per l'armadio / Pinze
ES Accesorio de cajón / Pinzas
CN 绝缘钳子托盘组套



180 mm; 1000V; CrV;
160 mm; 1000V; CrV;
160 mm; 1000V; CrV;
175 mm; 1000V



YATO
YT-55464

8

EN Drawer insert / Slotted screwdrivers
PL Wkład do szuflady / Wkrętaki płaskie
DE Schubladeneinlage / Flachschrauber
RU Вклад к выдвижному ящику / Плоские отвёртки
CZ Vložka do zásuvky / Šroubováky ploché
HU Fiókbetét / Lapos csavarhúzó
RO Adaos la sertar / Șurubelnițe plane
FR Module plastique pour servante avec trousseis
IT Tenone per l'armadio / Set di cacciaviti piatti
ES Accesorio de cajón / Desarmadores planos
CN 一字螺丝批托盘组套



3x75, 5x100, 5x150, 6x38, 6x100, 6x150, 8x150 mm; CrMo

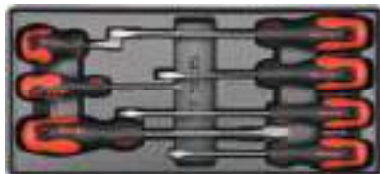

YATO
YT-5535

8

EN Drawer insert / Phillips screwdrivers
PL Wkład do szuflady / Wkrętaki krzyżakowe
DE Schubladeneinlage / Kreuzschlitzschrauber
RU Вклад к выдвижному ящику / Крестовидные отвёртки
CZ Vložka do zásuvky / Šroubováky křížové
HU Fiókbetét / Kereszt csavarhúzó
RO Adaos la sertar / Șurubelnițe în cruce
FR Module plastique pour servante avec trousseis
IT Tenone per l'armadio / Set di cacciaviti a croce
ES Accesorio de cajón / Desarmadores de cruz
CN 十字螺丝批托盘组套



PH0x100, PH1x75, PH1x100, PH2x38, PH2x100, PH2x150, PH3x150 mm; CrMo



YATO
YT-5536

8

EN Drawer insert / Screwdriver set
PL Wkład do szuflady / Komplet wkrętaków
DE Schubladeneinlage / Schraubendrehersatz
RU Вклад к выдвижному ящику / Набор отвёрток
CZ Vložka do zásuvky / Zámečnické šroubováky
HU Fiókbetét / Csavarhúzó készlet
RO Adaos la sertar / Șurubelnițe de lăcătușerie
FR Module plastique pour servante avec tournevis
IT Tenone per l'armadio / Set di cacciaviti
ES Accesorio de cajón / Juego de destornilladores
CN 螺丝批托盘组套

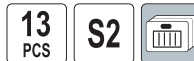

3x75, 5x75, 4x100, 6x100; PH0x75, PH1x75, PH2x100 mm; S2;
1.4x50, 2x50, 2.4x50 mm; PH00x50, PH0x50, PH1x50 mm; S2



YATO
YT-55455

8

EN Drawer insert / Go-through screwdrivers
PL Wkład do szuflady / Wkrętaki do pobrania
DE D Schubladeneinlage / Schlagschrauber
RU Вклад к выдвижному ящику / Отвёртка-било
CZ Vložka do zásuvky / Šroubovák s úderným koncem
HU Fiókbetét / Úthető csavarhúzó
RO Adaos la sertar / Șurubelniță pt. fixare
FR Module plastique pour servante / Allez - par tournevis
IT Tenone per l'armadio / Set di cacciaviti
ES Accesorio de cajón / Destornillador para dar golpes
CN 敲击螺丝批托盘组套



6x150, 8x200, PH2x150, PH3x200 mm; CrV



YATO
YT-55469

8

EN Drawer insert / Screwdriver set
 PL Wkład do szuflady / Komplet wkrętek
 DE Schubladeneinlage / Schraubendrehersatz
 RU Вклад к выдвижному ящику / Набор отвёрток
 CZ Vložka do zásuvky / Zámečnické šroubováky
 HU Fiókbetét / Csavarhúzó készlet
 RO Adaos la sertar / Şurubelnițe de lăcătuşerie
 FR Module plastique pour servante avec trounevis
 IT Tenone per l'armadio / Set di cacciaviti
 ES Accesorio de cajón / Juego de destornilladores
 CN 绝缘螺丝批托盘组套

8 PCS S2

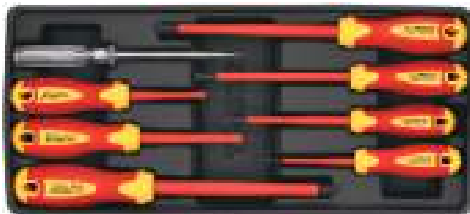

2.5x75, 4x100, 5.5x125, 6.5x150, PH1x80, PH2x100, PH3x150 mm; 1000V; S2;
 4x190 mm; 250V

YATO YT-55462 8

EN Drawer insert / Tool set
 PL Wkład do szuflady / Zestaw narzędziowy
 DE Schubladeneinlage / Werkzeug-Set
 RU Вклад к выдвижному ящику / Набор инструмента
 CZ Vložka do zásuvky / Sada nářadí
 HU Fiókbetét / Szerszámkészlet
 RO Adaos la sertar / Trusa de scule
 FR Module plastique pour servante / Coffret d'outillage
 IT Tenone per l'armadio / Set di utensilii
 ES Accesorio de cajón / Juego de herramientas
 CN 套筒托盘工具组套

4 PCS CrV



3/4" (19.0 mm); (200 mm); CrV 6140;
 3/4" (19.0 mm); CrV 50BV30;
 3/4" (19.0 mm); (500 mm); CrV 50BV30;
 3/4" (19.0 mm); (500 mm); 72T; CrV 6140

YATO YT-55458 4

EN Drawer insert / Socket set
 PL Wkład do szuflady / Zestaw kluczy nasadowych
 DE Schubladeneinlage / Steckschlüsselsatz
 RU Вклад к выдвижному ящику / Торцовые ключи
 CZ Vložka do zásuvky / Klíče nástrčné
 HU Fiókbetét / Dugókulcsok
 RO Adaos la sertar / Duză cheie
 FR Module plastique pour servante avec set d'outillages
 IT Tenone per l'armadio chiave a bussola
 ES Accesorio de cajón / Llaves de cubo
 CN 套筒托盘组套

22 PCS CrV

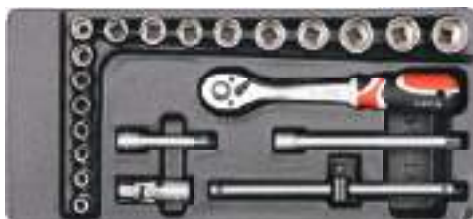

3/8" (9.5 mm): 6, 7, 8, 9, 10, 11, 12, 13, 14, 15, 16, 17, 18, 19, 20, 21, 22 mm; CrV 50BV30;
 3/8" (9.5 mm); (76, 152.4 mm); CrV 50BV30;
 3/8" (9.5 mm); CrV 50BV30;
 3/8" (9.5 mm); (198 mm); CrV 50BV30;
 3/8" (9.5 mm); (200 mm); 72T; CrV 6140

YATO YT-5542 8

EN Drawer insert / Socket set
 PL Wkład do szuflady / Zestaw kluczy nasadowych
 DE Schubladeneinlage / Steckschlüsselsatz
 RU Вклад к выдвижному ящику / Торцовые ключи
 CZ Vložka do zásuvky / Klíče nástrčné
 HU Fiókbetét / Dugókulcsok
 RO Adaos la sertar / Duză cheie
 FR Module plastique pour servante avec set d'outillages
 IT Tenone per l'armadio chiave a bussola
 ES Accesorio de cajón / Llaves de cubo
 CN 套筒托盘组套

25 PCS CrV



1/4" (6.3 mm): 3.5, 4, 4.5, 5, 5.5, 6, 7, 8, 9, 10, 11, 12, 13, 14 mm; CrV 50BV30;
 1/4" (6.3 mm): 8, 10, 11, 12, 13 mm; CrV 50BV30;
 1/4" (6.3 mm); (50.8, 101.6 mm); CrV 6140;
 1/4" (6.3 mm); CrV 50BV30;
 1/4" (6.3 mm); (152.4 mm); CrV 50BV30;
 1/4" (6.3 mm); (155 mm); 72T; CrV 6140;
 1/4" (6.3 mm); (150 mm); CrV 50BV30

YATO YT-5541 8

EN Drawer insert / Socket set
 PL Wkład do szuflady / Zestaw kluczy nasadowych
 DE Schubladeneinlage / Steckschlüsselsatz
 RU Вклад к выдвижному ящику / Торцовые ключи
 CZ Vložka do zásuvky / Klíče nástrčné
 HU Fiókbetét / Dugókulcsok
 RO Adaos la sertar / Duză cheie
 FR Module plastique pour servante avec set d'outillages
 IT Tenone per l'armadio chiave a bussola
 ES Accesorio de cajón / Llaves de cubo
 CN 套筒托盘组套

24 PCS CrV



1/2" (12.7 mm): 10, 11, 12, 13, 14, 15, 16, 17, 18, 19, 20, 21, 22, 23, 24, 27, 30, 32 mm; CrV 50BV30;
 1/2" (12.7 mm); (127 mm); CrV 50BV30;
 1/2" (12.7 mm); CrV 50BV30;
 1/2" (12.7 mm); 16; 21 mm; CrV 50BV30;
 1/2" (12.7 mm); (255 mm); CrV 50BV30;
 1/2" (12.7 mm); (255 mm); 72T; CrV 6140

YATO YT-5537 4

EN Drawer insert / Screwdriver bits
 PL Wkład do szuflady / Końcówki śrubokrętowe
 DE Schubladeneinlage / Endstücke für Schraubenzieher
 RU Вклад к выдвижному ящику / Насадки для отвёрток
 CZ Vložka do zásuvky / Šroubovací nástavce
 HU Fiókbetét / Csavarhúzó bitek
 RO Adaos la sertar / Terminații pt. şurubelnițe
 FR Module plastique pour servante avec set d'embouts
 IT Tenone per l'armadio chiave punti di avvitamento
 ES Accesorio de cajón / Puntas para desarmadores
 CN 旋具头托盘组套

40 PCS S2



T20, T25, T30, T40, T45, T50, T55 (L=30 mm); T20, T25, T30, T40, T45, T50, T55 (L=75 mm); AISI S2;
 4, 5, 6, 7, 8, 10, 12 (L=30 mm); 4, 5, 6, 7, 8, 10, 12 (L=75 mm); AISI S2;
 M5, M6, M8, M10, M12 (L=30 mm); M5, M6, M8, M10, M12 (L=75 mm); AISI S2;
 1/2" (12.7 mm), 3/8" (9.5 mm)

YATO YT-5538 8

EN Drawer insert / Socket set
PL Wkład do szuflady / Zestaw kluczy nasadowych
DE Schubladeneinlage / Steckschlüsselsatz
RU Вклад к выдвижному ящику / Торцовые ключи
CZ Vložka do zásuvky / Klíče nástrčné
HU Fiókbetét / Dugókulcsok
RO Adaos la sertar / Duză cheie
FR Module plastique pour servante avec set d'outillages
IT Tenone per l'armadio chiave a bussola
ES Accesorio de cajón / Llaves de cubo
CN 套筒托盘工具组套

14
PCS CrV
50BV30



3/4" (19.0 mm): 19, 21, 22, 24, 27, 28, 30, 32, 34, 36, 41, 46, 50, 55 mm; CrV 50BV30

YATO
YT-55457 4

EN Drawer insert / Tool set
PL Wkład do szuflady / Zestaw narzędziowy
DE Schubladeneinlage / Werkzeug-Set
RU Вклад к выдвижному ящику / Набор инструмента
CZ Vložka do zásuvky / Sada nářadí
HU Fiókbetét / Szerszámkészlet
RO Adaos la sertar / Trusa de scule
FR Module plastique pour servante / Coffret d'outillage
IT Tenone per l'armadio / Set di utensili
ES Accesorio de cajón / Juego de herramientas
CN 旋具托盘组套

31
PCS CrV S2



1/2" (12.7 mm): E10, E12, E14, E16, E18, E20 (L=38 mm); CrV 50BV30;

1/2" (12.7 mm): 10 mm; CrV 6150;

M5, M6, M8, M10, M12 (L=30 mm); AISI S2;

2, 2.5, 3, 4, 5, 6, 7, 8, 10, 12 mm; CrV 6150;

T10, T15, T20, T25, T27, T30, T40, T45, T50; CrV 6150

YATO
YT-55451 8

EN Drawer insert / Measuring tools
PL Wkład do szuflady / Narzędzia miernicze
DE Schubladeneinlage / Messwerkzeuge
RU Вклад к выдвижному ящику / Измерительные приборы
CZ Vložka do zásuvky / Měření
HU Fiókbetét / Mérészközök
RO Adaos la sertar / Instrumente de măsură
FR Module plastique pour servante / Outils de mesurage
IT Tenone per l'armadio / Strumenti di misura
ES Accesorio de cajón / Instrumentos de medición
CN 量具托盘组套

5
PCS AI SS ABS



300 mm; AI;

0-150 mm; SS;

2 m;

3m x 16 mm; ABS;

0.02-1.00 mm

YATO
YT-55474 8

EN Drawer insert / Deep sockets
PL Wkład do szuflady / Klucze nasadowe długie
DE Schubladeneinlage / Tiefe Steckschlüssel
RU Вклад к выдвижному ящику / Торцовые глубокие ключи
CZ Vložka do zásuvky / Klíče nástrčné hluboké
HU Fiókbetét / Hosszú dugókulcsok
RO Adaos la sertar / Prize de curent adânci
FR Module plastique pour servante avec set de douilles
IT Tenone per l'armadio chiave a bussola lunga
ES Accesorio de cajón / Llaves de cubo profundo
CN 六角长套筒托盘组套

14
PCS CrV
50BV30



1/2" (12.7 mm): 8, 9, 10, 11, 12, 13, 14, 15, 16, 17, 18, 19, 20, 21 mm (L=76 mm); CrV 50BV30

YATO
YT-5539 8

EN Drawer insert / Hammers and chisels
PL Wkład do szuflady / Młotki i przecinaki
DE Schubladeneinlage / Hammer und Meißel
RU Вклад к выдвижному ящику / Молотки и зубила
CZ Vložka do zásuvky / Kladiva, dřáta a sekáče
HU Fiókbetét / Kalapácsok és hidegvágók
RO Adaos la sertar / Ciocane și dălți
FR Module plastique pour servante avec marteaux et burins
IT Tenone per l'armadio martelli e scalpelli
ES Accesorio de cajón / Martillos y cinceles
CN 锤头凿子托盘组套

5
PCS CrV



300 g (L=300 mm);

40 mm (L=350 mm);

10x8x142 mm, 12x10x152 mm, 16x13x172 mm; CrV

YATO
YT-5540 8

EN Drawer insert / Steel file set
PL Wkład do szuflady / Pilniki do metalu
DE Schubladeneinlage / Feilensatz
RU Вклад к выдвижному ящику / Набор напильников
CZ Vložka do zásuvky / Pilníky na kov
HU Fiókbetét / LLakatos reszelő készlet
RO Adaos la sertar / Pile de lăcătușerie
FR Module plastique pour servante / Set de limes à métal
IT Tenone per l'armadio / Set di lime per metallo
ES Accesorio de cajón / Juego de limas para metal
CN 锉刀托盘组套

5
PCS T12



#2, 200 mm; T12;

#2, 200 mm; T12;

#2, 200 mm; T12;

#2, 200 mm; T12;

#2, 200 mm; T12

YATO
YT-55453 8

EN Drawer insert / Hand riveter with rivets
 PL Wkład do szuflady / Nitownica ręczna z głowicą obrotową
 DE Schubladeneinlage / Blindnietzange
 RU Вклад к выдвижному ящику / Ручной заклёпочник
 CZ Vložka do zásuvky / Ruční nýtovačka
 HU Fiókbetét / Kézi popszegecshúzó
 RO Adaos la sertar / Pcleşte pt. popnituri
 FR Module plastique pour servante / Riveteuse a main
 IT Tenone per l'armadio / Rivettatrice manuale girevole
 ES Accesorio de cajón / Remachadora de mano
 CN 拉柳枪托盘组套



2.4, 3.2, 4.0, 4.8 mm; CrV;
 9.6x3.2, 9.6x4.0, 12.7x4.0, 9.6x4.8, 12.7x4.8 mm; Al

YATO **YT-55466** 8

EN Drawer insert / Tool set
 PL Wkład do szuflady / Zestaw narzędziowy
 DE Schubladeneinlage / Werkzeug-Set
 RU Вклад к выдвижному ящику / Набор инструмента
 CZ Vložka do zásuvky / Sada nářadí
 HU Fiókbetét / Szerszámkészlet
 RO Adaos la sertar / Trusa de scule
 FR Module plastique pour servante / Coffret d'outillage
 IT Tenone per l'armadio / Set di utensili
 ES Accesorio de cajón / Juego de herramientas
 CN 工具托盘组套



1" (25 mm), L=330 mm; CrV;
 250 mm; CrMo;
 2.4, 3.2, 4.0, 4.8 mm;
 9.6x3.2, 9.6x4.0, 12.7x4.8 mm; Al

YATO **YT-55478** 8

EN Drawer insert / Automotive workshop tools
 PL Wkład do szuflady / Zestaw narzędzi warsztatowych
 DE Schubladeneinlage / Kfz-werkzeuge
 RU Вклад к выдвижному ящику / Автомобильные инструменты
 CZ Vložka do zásuvky / Auto nářadí
 HU Fiókbetét / Autóipari szerszámok
 RO Adaos la sertar / Scule auto
 FR Module plastique pour servante / Outils de réparation automobile
 IT Tenone per l'armadio / Set attrezzi officina
 ES Accesorio de cajón / Herramientas de automoción
 CN 轮胎修理工具托盘组套



200 mm;
 135 mm;
 300, 400, 500 mm; CrV

YATO **YT-55477** 4

EN Drawer insert / Automotive workshop tools
 PL Wkład do szuflady / Zestaw narzędzi warsztatowych
 DE Schubladeneinlage / Kfz-werkzeuge
 RU Вклад к выдвижному ящику / Автомобильные инструменты
 CZ Vložka do zásuvky / Auto nářadí
 HU Fiókbetét / Autóipari szerszámok
 RO Adaos la sertar / Scule auto
 FR Module plastique pour servante / Outils de réparation automobile
 IT Tenone per l'armadio / Set attrezzi officina
 ES Accesorio de cajón / Herramientas de automoción
 CN 轮胎修理工具托盘组套



1/2" (12.7 mm) x 5/16" (7.9 mm); CrV 6150;
 8 mm (L=35 mm); 8 mm (L=75 mm); CrV 6150;
 PH3 (L=35 mm); PH1, PH2, PH3 (L=75 mm); CrV 6150;
 12-38 mm; CrV 6150;
 3" (75 mm); CrV;
 82 mm; CrV

YATO **YT-55476** 4

EN Drawer insert / Tool set
 PL Wkład do szuflady / Zestaw narzędziowy
 DE Schubladeneinlage / Werkzeug-Set
 RU Вклад к выдвижному ящику / Набор инструмента
 CZ Vložka do zásuvky / Sada nářadí
 HU Fiókbetét / Szerszámkészlet
 RO Adaos la sertar / Trusa de scule
 FR Module plastique pour servante / Coffret d'outillage
 IT Tenone per l'armadio / Set di utensili
 ES Accesorio de cajón / Juego de herramientas
 CN 工具托盘组套



140 mm; SS;
 200 mm; 3Cr13;
 19 mm x 20 mm;
 4x190 mm; 250 V;
 1, 1.5, 2, 2.5, 3, 3.5, 4, 4.5, 5, 5.5, 6, 6.5, 7, 7.5, 8, 8.5, 9, 9.5, 10 mm; HSS 6542

YATO **YT-55471** 8

EN Drawer insert / Taps and die set
 PL Wkład do szuflady / Zestaw narzynek i gwintowników
 DE Schubladeneinlage / Gewindeschneidwerkzeug-Satz
 RU Вклад к выдвижному ящику / Набор плашек и метчиков
 CZ Vložka do zásuvky / Souprava závitníků a kruhových závitových čelistí
 HU Fiókbetét / Menetűró és menetvágó készlet
 RO Adaos la sertar / Set de larozii și fi liere
 FR Module plastique pour servante / Pince a riveter avec embouts
 IT Tenone per l'armadio / Set di fi liera a maschi
 ES Accesorio de cajón / Juego de machos de roscar y cojinetes
 CN 丝锥扳牙托盘组套



M3x0.5 x3, M4x0.7x3, M5x0.8 x3, M6x1.0 x3, M7x1.0 x3, M8x1.25, M10x1.5, M12x1.75; HSS M2;
 M3x0.5, M4x0.7, M5x0.8, M6x1.0, M7x1.0, M8x1.25, M10x1.5, M12x1.75; HSS M2;
 M7-M9;
 M3-M12;
 0.5 - 1.75 mm; 27G; 28G

YATO **YT-55465** 8

EN Drawer insert
PL Wkład do szuflady
DE Schubladeneinlage
RU Вклад к выдвижному ящику
HU Fiókbelét

RO Adaos la sertar
FR Module plastique pour servante
IT Tenone per l'armadio
ES Accesorio de cajón
CN 吸塑盒



For YT-5531
Dla YT-5531

YATO	
YT-55311	5/30



For YT-5532
Dla YT-5532

YATO	
YT-55321	5/30



For YT-5533
Dla YT-5533

YATO	
YT-55331	5/30



For YT-5534
Dla YT-5534

YATO	
YT-55341	5/30

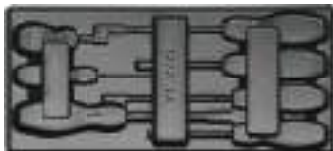

For YT-5535
Dla YT-5535

YATO	
YT-55351	5/30

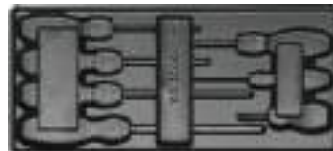

For YT-5536
Dla YT-5536

YATO	
YT-55361	5/30



For YT-5537
Dla YT-5537

YATO	
YT-55371	5/30



For YT-5538
Dla YT-5538

YATO	
YT-55381	5/30

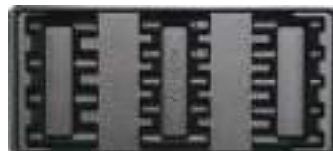

For YT-5539
Dla YT-5539

YATO	
YT-55391	5/30



For YT-5540
Dla YT-5540

YATO	
YT-55401	5/30

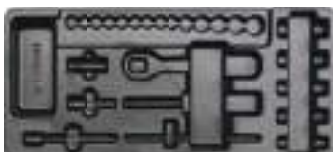

For YT-5541
Dla YT-5541

YATO	
YT-55411	5/30



For YT-5542
Dla YT-5542

YATO	
YT-55421	5/30



For YT-55479
Dla YT-55479

YATO	
YT-55479	5/30

EN Legs for workbench, long
PL Nogi do stołu warsztatowego, długie
DE Beine für Werkbank, lange
RU Ножки для верстака, длинные
CZ Nohy k pracovnímu stolu, dlouhé
HU Lábak munkapadhoz
RO Picioare pt. banc de lucru, lungi
FR Jambes pour table d'atelier
IT Gambe del tavolo piedi del banco da lavoro
ES Patas para banco de trabajo, largas
CN 工作台长桌腿

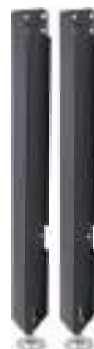

2
PCS

140
cm



For YT-08920
Dla YT-08920

YATO	L [mm]	
YT-08921	1400	2

EN Holders for workshop box
PL Uchwyty do montażu szafki warsztatowej
DE Halterungen für die Montage eines Werkstattsschranks
RU Крепеж для рабочего шкафа
CZ Montážní držáky dílenské skřínky
HU Műhelyszekrény tartó
RO Suporturi pt. montarea dulapului de atelier
FR Porte-placard d'atelier
IT Staffa di montaggio per armadio portautensili
ES Elementos de fijación para instalación de cajón de taller
CN 高档工作台吊柜架



2
PCS

500x100
x350
mm



For YT-08920, YT-09152
Dla YT-08920, YT-09152

YATO	Dimensions / Wymiary [mm]	
YT-08922	500x100x350	2

- EN Connection steel pipes set
- PL Rury montażowe
- DE Anschluss Stahlrohre Gesetzt
- RU Стальная труба монтаж
- CZ Ocelové trubky
- HU Acélcsővek
- RO Tevi din oțel
- FR Tuyaux en acier
- IT Set di montaggio per tabella utensili
- ES Tubos de acero
- CN 高档工具柜定位杆

2 PCS	45 cm	\varnothing 28 mm	
-----------------	-----------------	-------------------------------	---



For YT-09152, YT-09155 + YT-0902, YT-0903, YT-0904
Dla YT-09152, YT-09155 + YT-0902, YT-0903, YT-0904



YATO 	L [mm]	Ø [mm]	
YT-09071	450	28	20

- EN Compartmented shelf and paper roll holder
- PL Półka z uchwytem na papier
- DE Werkstattwagenablage mit Papierrollhalter
- RU Полка с держателем для бумаги
- CZ Police s uchytym na papír
- HU Kiegészítő polc és papírrölni tartó funkcióval
- RO Compartiment pt. dulap si suport hartie
- FR Support rouleau papier
- IT Mensola portarotoli carta
- ES Estante con sujetapapel
- CN 托架

305x305 x145 mm	
------------------------------	---



For YT-0902, YT-0903, YT-0904, YT-0905
Dla YT-0902, YT-0903, YT-0904, YT-0905

YATO 	Dimensions / Wymiary [mm]	
YT-0907	305x305x145	4

- EN Separate board for drawer
- PL Przegródka do szafki
- DE Trennsteg für Werkstatt-Wagen-Schublade
- RU Перегородки для ящика
- CZ Pňíhádka do police
- HU Több rekeszes fálca
- RO Sertar separat de masura mica
- FR Cloison tiroir court
- IT Separatore per armadio
- ES Separador para armario
- CN 抽屉分隔板



For YT-0902, YT-0903, YT-0904, YT-0905
Dla YT-0902, YT-0903, YT-0904, YT-0905



YATO 	Dimensions / Wymiary [mm]	
YT-0910	391x58x4	24
YT-0911	391x128x4	24

- EN Double project center backwall
- PL Tablica narzędziowa
- DE Werkzeugwand
- RU Доска инструмент
- CZ Držáky na nářadí
- HU Szerszámtartó fal akasztókkal
- RO Suport perete scule
- FR Mur d'outil
- IT La tabella utensili
- ES Panel de herramientas
- CN 高档工具车挂板

2 PCS	652x610 x55 mm	
-----------------	-----------------------------	---



For YT-0902, YT-0903, YT-09031, YT-0904, YT-55290, YT-55292, YT-55293, YT-5530
Dla YT-0902, YT-0903, YT-09031, YT-0904, YT-55290, YT-55292, YT-55293, YT-5530



YATO 	Dimensions / Wymiary [mm]	
YT-09072	652x610x55	1

- EN Dustbin
- PL Pojemnik na odpady
- DE Abfallimer
- RU Мусорный ящик
- CZ Zásobník na odpad
- HU Szemétkosár
- RO Lada de gunoi
- FR Poubelle
- IT Contenitore di rifiuti
- ES Cubo de basura
- CN 废品箱

300x300 x190 mm	
------------------------------	---





For YT-0902, YT-0903, YT-0904, YT-0905
Dla YT-0902, YT-0903, YT-0904, YT-0905

YATO 	Dimensions / Wymiary [mm]	
YT-0908	300x300x190	4



For YT-0902, YT-0903, YT-0904, YT-0905
Dla YT-0902, YT-0903, YT-0904, YT-0905

YATO 	Dimensions / Wymiary [mm]	
YT-0910	391x58x4	24
YT-0911	391x128x4	24

EN Magnetic towel holder
PL Magnetyczny uchwyt na ręczniki
DE Magnetischer Rollenhalter
RU Магнитная вешалка для бумаги
CZ Držáků magnetických papírových ručníků
HU Mágneses papírtörő állvány

RO Suportji magnetici pt. prosoape
FR Porte-serviettes en papier magnétique
IT Portasciugamani magnetico
ES Magnético de papel toallero
CN 磁性纸巾挂架



YATO
YT-08680

24

EN Magnetic shelf
PL Półka magnetyczna
DE Magnetische Ablage
RU Магнитная полка для тележки
CZ Magnetický regál pro nářadí
HU Mágneses polc szerszámkocsikhoz

RO Cutie magnetice pt. depozitare
FR Magnétique plat
IT Mensola magnetica
ES Soporte de almacenamiento magnético
CN 磁性工具箱



YATO
YT-08681

10

EN Magnetic tool tray set
PL Zestaw półek magnetycznych
DE Magnetische Werkzeugablage Set

RU Набор магнитных полок для тележки
CZ Sada magnetických poliček
HU Mágneses polc készlet

RO Cutii magnetice pt. depozitare
FR Magnétique étagères set
IT Set di ripiani magnetici

ES Juego de estantes magnéticos
CN 磁性工具盘

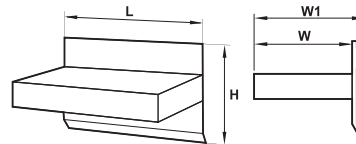

	L (mm)	H (mm)	W (mm)	W1 (mm)
	310	120	115	125
	270	120	115	125
	210	120	115	125
	155	120	115	125

YATO
YT-08682

6

EN Magnetic hooks set
PL Zestaw haczyków magnetycznych
DE Magnetische Haken Set
RU Набор магнитных крючков для тележки
CZ Sada magnetických háčků
HU Mágneses kampók halmaza

RO Set de cârlige magnetice
FR Ensemble de crochets magnétiques
IT Set di ganci magnetici
ES Conjunto de ganchos magnéticos
CN 磁性挂钩



YATO
YT-08690

12/48

EN Hook for panel
PL Haczyki do panelu perforowanego
DE Haken für perforierte Wände
RU Гачки для стёнки с перфорацией
CZ Háčky pro stěnu s perforací
HU Horgok perforált panelhez

RO Cârlije pt. panouri perforate
FR Crochets pour le mur avec perforation
IT Ganci per pannelli forati
ES Ganchos para pared con perforación
CN 挂钩

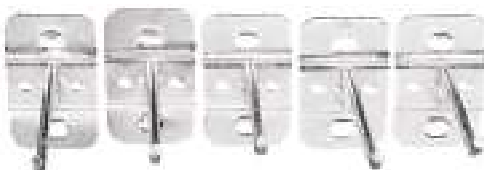

For YT-08936
Dla YT-08936



YATO
YT-08937

20

EN Service utility key
PL Klucz do szafek serwisowych
DE Schaltschrank-Schlüssel für Gängige Schränke
RU Ключ для сервисных шкафов
CZ Klíč na rozvodné skříně
HU Kapcsolószekrény kulcs
RO Cheie universala pt. panoul de comanda
FR Clés universelles pour armoires de commande
IT Chiave universale a croce per armadietti
ES Llaves para armarios de control
CN 多用阀门钥匙

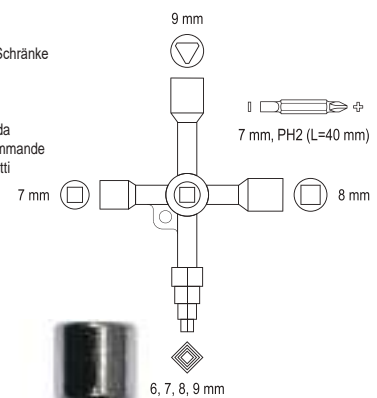



YATO
YT-66700



20/120

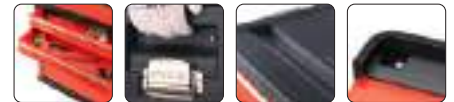

- | | | |
|--------------------------|----------------------|---------------------------|
| EN Tool box | CZ Skříňka na nářadí | IT Casseta degli attrezzi |
| PL Skrzynka narzędziowa | HU Szerszámcs láda | ES Caja de herramientas |
| DE Werkzeugkasten | RO Cutie de scule | CN 一抽屉工具组套 |
| RU Инструментальный ящик | FR Boîte à outils | |



YATO 	Drawer quantity / Liczba szuflad	
YT-09108	1	2

YATO 	Drawer quantity / Liczba szuflad	
YT-09107	2	2

- | | | |
|----------------------------------|-----------------------|-------------------------|
| EN Tool trolley | CZ Vozík na nářadí | IT Armadio per utensili |
| PL Wózek narzędziowy 3-częściowy | HU Szerszám kocsi | ES Herramienta carro |
| DE Werkzeugkasten | RO Troler pt. scule | CN 拉杆式工具箱 |
| RU Тележка инструментальная | FR Servante d'atelier | |



YATO 		
YT-09102		1

YATO 		
YT-09101		1

EN Tool trolley
PL Wózek narzędziowy 3-częściowy z narzędziami
DE Werkzeugkasten
RU Тележка инструментальная

CZ Vozík na nářadí
HU Szerszám kocs
RO Troler cu scule
FR Servante d'atelier

IT Armadio per utensili
ES Herramienta carro
CN 手推式工具箱



Drawer 1 / Szuflada 1

- 1/2" (12.7 mm): 8, 10, 12, 13, 14, 15, 16, 17, 18, 19, 20, 21, 22 mm; CrV 50BV30;
- 1/2" (12.7 mm); (127 mm); CrV 50BV30;
- 1/2" (12.7 mm); (255 mm); 72T; CrV 6140;
- 3x75, 6x100; PH0x75, PH2x100 mm; S2;
- 215 mm;
- 1/4" (6.3 mm): 3.0, 3.5, 4.0, 5.5, 6.5 mm (L=25 mm); S2;
- 1/4" (6.3 mm): PH0, PH1, PH2, PH3 (L=25 mm); S2;
- 1/4" (6.3 mm): PZ0, PZ1, PZ2, PZ3 (L=25 mm); S2;
- 1/4" (6.3 mm): T10, T15 (L=25 mm); S2;
- 1/4" (6.3 mm): 2, 3, 4, 5, 6 mm (L=25 mm); S2;
- 1/4" (6.3 mm): 5, 6, 7, 8 x2, 9, 10, 11, 12, 13 mm

Drawer 2 / Szuflada 2

- 8, 10, 12, 13, 14, 15, 16, 17, 18, 19, 21 mm; CrV;
- 18 mm; SK5;
- 18 mm; SK5;
- 3 m x 16 mm

Drawer 3 / Szuflada 3

- 180 mm;
- 160 mm;
- 200 mm;
- 300 mm; 16-38 mm;
- 2, 2.5, 3, 4, 5, 6, 7, 8, 10, 12 mm; CrV 6150

78
PCS

3
TRAYS
FACE



YATO
YT-09104



1

EN Hermetic toolbox
PL Walizka narzędziowa hermetyczna
DE Hermetischer Werkzeugkoffer
RU Герметичный инструментальный чемодан

232x192
x111
mm



IP55

PP

CZ Kufř na nářadí hermetický
HU Hermetikus szerszámosláda
RO Cutie scule ermetica
FR Valise à outils étanche
IT Valigetta portautensili a tenuta stagna
ES Caja de herramientas hermética
CN 安全箱



YATO	External dimensions / Wymiary zewnętrzne [mm]		Internal dimensions / Wymiary wewnętrzne [mm]		Icon
	YT-08900	232x192x111	208x144x92	12	

EN Hermetic toolbox
PL Walizka narzędziowa hermetyczna
DE Hermetischer Werkzeugkoffer
RU Герметичный инструментальный чемодан

270x246
x124
mm



IP55

PP

CZ Kufř na nářadí hermetický
HU Hermetikus szerszámosláda
RO Cutie scule ermetica
FR Valise à outils étanche
IT Valigetta portautensili a tenuta stagna
ES Caja de herramientas hermética
CN 安全箱



YATO	External dimensions / Wymiary zewnętrzne [mm]		Internal dimensions / Wymiary wewnętrzne [mm]		Icon
	YT-08901	270x246x124	235x181x105	8	

EN Hermetic toolbox
PL Walizka narzędziowa hermetyczna
DE Hermetischer Werkzeugkoffer
RU Герметичный инструментальный чемодан

339x295
x152
mm



IP55

PP

CZ Kufř na nářadí hermetický
HU Hermetikus szerszámosláda
RO Cutie scule ermetica
FR Valise à outils étanche
IT Valigetta portautensili a tenuta stagna
ES Caja de herramientas hermética
CN 安全箱



YATO	External dimensions / Wymiary zewnętrzne [mm]		Internal dimensions / Wymiary wewnętrzne [mm]		Icon
	YT-08902	345x295x152	300x225x132	4	

EN Hermetic toolbox
PL Walizka narzędziowa hermetyczna
DE Hermetischer Werkzeugkoffer
RU Герметичный инструментальный чемодан

406x330
x174
mm



IP55

PP

CZ Kufř na nářadí hermetický
HU Hermetikus szerszámosláda
RO Cutie scule ermetica
FR Valise à outils étanche
IT Valigetta portautensili a tenuta stagna
ES Caja de herramientas hermética
CN 安全箱



YATO	External dimensions / Wymiary zewnętrzne [mm]		Internal dimensions / Wymiary wewnętrzne [mm]		Icon
	YT-08903	406x330x174	371x258x152	2	

EN Hermetic toolbox
PL Walizka narzędziowa hermetyczna
DE Hermetischer Werkzeugkoffer
RU Герметичный инструментальный чемодан

470x357
x176
mm



IP55

PP

CZ Kufř na nářadí hermetický
HU Hermetikus szerszámosláda
RO Cutie scule ermetica
FR Valise à outils étanche
IT Valigetta portautensili a tenuta stagna
ES Caja de herramientas hermética
CN 安全箱



YATO	External dimensions / Wymiary zewnętrzne [mm]		Internal dimensions / Wymiary wewnętrzne [mm]		Icon
	YT-08904	470x357x176	425x284x155	2	

EN Hermetic toolbox
PL Walizka narzędziowa hermetyczna
DE Hermetischer Werkzeugkoffer
RU Герметичный инструментальный чемодан

569x425
x215
mm



IP55

PP

CZ Kufř na nářadí hermetický
HU Hermetikus szerszámosláda
RO Cutie scule ermetica
FR Valise à outils étanche
IT Valigetta portautensili a tenuta stagna
ES Caja de herramientas hermética
CN 安全箱



YATO	External dimensions / Wymiary zewnętrzne [mm]		Internal dimensions / Wymiary wewnętrzne [mm]		Icon
	YT-08906	569x425x215	505x350x140	2	

EN Hermetic toolbox
 PL Walizka narzędziowa hermetyczna
 DE Hermetischer Werkzeugkoffer
 RU Герметичный инструментальный чемодан
 CZ Kufř na nářadí hermetický
 HU Hermetikus szerszámosláda

RO Cutie scule ermetica
 FR Valise à outils étanche
 IT Valigetta portautensili a tenuta stagna
 ES Caja de herramientas hermética
 CN 安全箱

559x351
x229
mm

ø60 mm

DECOMPRESSION
VALVE
ZAWÓR
DEKOMPRESYJNY

SHOCK-
PROOF
ODPORNA
NA WSTRZĄSY

FOAM
INSERT
WKŁAD
GĄBKOWY

IP55

PP



YATO	External dimensions / Wymiary zewnętrzne [mm]	Internal dimensions / Wymiary wewnętrzne [mm]	
YT-08905	559x351x229	501x279x193	1

EN Hermetic toolbox
 PL Walizka narzędziowa hermetyczna
 DE Hermetischer Werkzeugkoffer
 RU Герметичный инструментальный чемодан
 CZ Kufř na nářadí hermetický
 HU Hermetikus szerszámosláda
 RO Cutie scule ermetica
 FR Valise à outils étanche
 IT Valigetta portautensili a tenuta stagna
 ES Caja de herramientas hermética
 CN 安全箱

430x244
x341
mm

DECOMPRESSION
VALVE
ZAWÓR
DEKOMPRESYJNY

SHOCK-
PROOF
ODPORNA
NA WSTRZĄSY

FOAM
INSERT
WKŁAD
GĄBKOWY

IP55

PP



YATO	External dimensions / Wymiary zewnętrzne [mm]	Internal dimensions / Wymiary wewnętrzne [mm]	
YT-08907	430x244x341	344x146x297	2

EN Cantilever tool box
 PL Skrzynka narzędziowa
 DE Werkzeugkoffer
 RU Инструментальный ящик
 CZ Nástrojová skříňka
 HU Szerszámosláda

RO Cutie pt. scule
 FR Boîte à outils
 IT Cassetta degli attrezzi
 ES Caja de herramientas
 CN 手提工具箱

360x150
x115
mm



YATO	Dimensions / Wymiary [mm]	
YT-0882	360x150x115	4

EN Cantilever tool box
 PL Skrzynka narzędziowa
 DE Werkzeugkoffer
 RU Инструментальный ящик
 CZ Nástrojová skříňka
 HU Szerszámosláda

RO Cutie pt. scule
 FR Boîte à outils
 IT Cassetta degli attrezzi
 ES Caja de herramientas
 CN 手提工具箱



YATO	Dimensions / Wymiary [mm]	
YT-0883	428x180x180	1

EN Cantilever tool box
 PL Skrzynka narzędziowa
 DE Werkzeugkoffer
 RU Инструментальный ящик
 CZ Nástrojová skříňka
 HU Szerszámosláda

RO Cutie pt. scule
 FR Boîte à outils
 IT Cassetta degli attrezzi
 ES Caja de herramientas
 CN 工具箱



YATO	Dimensions / Wymiary [mm]	
YT-0884	460x200x180	1

EN Cantilever tool box
 PL Skrzynka narzędziowa
 DE Werkzeugkoffer
 RU Инструментальный ящик
 CZ Nástrojová skříňka
 HU Szerszámosláda
 RO Cutie pt. scule
 FR Boîte à outils
 IT Cassetta degli attrezzi
 ES Caja de herramientas
 CN 工具箱

460x200
x225
mm



YATO	Dimensions / Wymiary [mm]	
YT-0885	460x200x225	1

EN Cantilever tool box
 PL Skrzynka narzędziowa
 DE Werkzeugkoffer
 RU Инструментальный ящик
 CZ Nástrojová skříňka
 HU Szerszámosláda
 RO Cutie pt. scule
 FR Boîte à outils
 IT Cassetta degli attrezzi
 ES Caja de herramientas
 CN 手提工具箱



YATO	Dimensions / Wymiary [mm]	
YT-0886	510x220x240	1

EN Cantilever tool box
 PL Skrzynka narzędziowa
 DE Werkzeugkoffer
 RU Инструментальный ящик

CZ Nástrojová skříňka
 HU Szerszámosláda
 RO Cutie pt. scule
 FR Boîte à outils

IT Cassetta degli attrezzi
 ES Caja de herramientas
 CN 工具箱



2x



3x



4x

YATO	Drawer quantity / Liczba szuflad	Dimensions / Wymiary [mm]	
YT-08872	2	218x255x520	1

YATO	Drawer quantity / Liczba szuflad	Dimensions / Wymiary [mm]	
YT-08873	3	218x300x520	1

YATO	Drawer quantity / Liczba szuflad	Dimensions / Wymiary [mm]	
YT-08874	4	218x360x520	1

EN Tool box with tools
PL Skrzynka z narzędziami
DE Werkzeugkoffer
RU Инструментальный ящик
CZ Nástrojová skříňka
HU Szerszámosláda
RO Cutie pt. scule
FR Boîte d'outils
IT Cassetta degli attrezzi
ES Caja de herramientas
CN 工具组套



62
PCS





1/2"
12.7mm

CrV
50BV30

CrV
6150

CrV
6140

72T

AS-DRIVE    

 1/2" (12.7 mm): 10, 11, 12, 13, 14, 15, 16, 17, 18, 19, 20, 21, 22, 23, 24 mm (L=38 mm); 27, 30, 32 mm (L=42 mm); CrV 50BV30;

 1/2" (12.7 mm): (76, 127, 254 mm); CrV 50BV30;

 1/2" (12.7 mm): CrV 50BV30;

 1/2" (12.7 mm): 21 mm; CrV 50BV30;

 1/2" (12.7 mm): (255 mm); CrV 50BV30;

 1/2" (12.7 mm); 72T; CrV 6140;

 1/2" (12.7 mm): (450 mm); CrV 50BV30;

 6, 7, 8, 9, 10, 11, 12, 13, 14, 15, 16, 17, 18, 19, 20, 21, 22, 24 mm; CrV;

 6x100, 6x150, 8x200 mm; CrV 6150;

 PH2x100, PH3x150, PH3x200 mm; CrV 6150;



 180 mm; CrV;

 160 mm; CrV;

 160 mm; CrV;

 1.5, 2, 2.5, 3, 4, 5, 6, 8, 10 mm; CrV 6150



YATO  Dimensions / Wymiary [mm] 
YT-3895 475x230x365 1

EN Tool box with tools
PL Skrzynka z narzędziami
DE Werkzeugkoffer
RU Инструментальный ящик
CZ Nástrojová skříňka
HU Szerszámosláda

RO Cutie pt. scule
FR Boîte d'outils
IT Cassetta degli attrezzi
ES Caja de herramientas
CN 工具组套



80
PCS



460x220
x245
mm

1/2"
12.7mm

1/4"
6.3mm

CrV
50BV30

CrV
6140

S2 **72T** AS-DRIVE    

 1/2" (12.7 mm): 10, 11, 12, 13, 14, 15, 17, 19 mm (L=38 mm);

 1/4" (6.3 mm): 5, 6, 7, 8, 9, 10, 11, 12, 13 mm (L=25 mm); CrV 50BV30;

 1/2" (12.7 mm): 21 mm; CrV 50BV30;

 1/2" (12.7 mm): (255 mm); 72T; CrV 6140;

 1/4" (6.3 mm): (150 mm); CrV 50BV30;

 1/4" (6.3 mm) x 1/4" (6.3 mm); CrV 50BV30;

 1/4" (6.3 mm): 3 x2, 4 x2, 5 x2, 5.5 x2, 6 x2 mm (L=25 mm); AISI S2;

 1/4" (6.3 mm): PH0, PH1 x2, PH2 x2, PH3 (L=25 mm); AISI S2;

 1/4" (6.3 mm): PZ0, PZ1 x2, PZ2 (L=25 mm); AISI S2;

 6, 7, 8, 9, 10, 11, 12, 13, 14, 15, 17, 19 mm; CrV;

 5x75 mm, 6x100 mm, 8x150 mm, PH1x75 mm, PH2x100 mm; S2;

 180 mm; CrV;

 160 mm; CrV;

 160 mm; CrV;

 250 mm;



 300 g;

 18 mm; SK2;

 18x0.5 mm; SK2;

 1.5, 2, 2.5, 3, 4, 5, 5.5, 6 mm; T10, T15, T20, T25, T27, T30, T40; CrV





YATO  Dimensions / Wymiary [mm] 
YT-38951 460x220x245 1

EN Oil filter chain wrench
 PL Klucz łańcuchowy do filtrów oleju
 DE Ölfilter-Kettenschlüssel
 RU Цепной ключ для масляных фильтров
 CZ Klíč na olejové filtry řetězový
 HU Olajszűrő leszedő láncos
 RO Cheie cu lanț pt. filtre ulei
 FR Clé à chaîne pour filtre à huile
 IT Chiave a catena per filtri olio
 ES Llave de cadena para filtros de aceite
 CN 过滤器链式扳手





1/2"
12.7mm
DOUBLE CHAIN
PODWÓJNY
LANCUCH
CrV

YATO 	Ø [mm]	
YT-08253	60-115	5/30
YT-08254	75-170	5/30

EN Oil filter wrench
 PL Klucz do filtra oleju
 DE Ölfilterschlüssel
 RU Съёмник масляного фильтра
 CZ Klíč na olejový filtr
 HU Olajszűrő leszedő
 RO Cheie pt. filtru de ulei
 FR Clé pour filtre à huile
 IT Chiave per filtro olio
 ES Llave para filtro de aceite
 CN 滤清器扳手



1/2"
12.7mm
CrMo

YATO 	Ø [mm]	
YT-08235	60-80	20
YT-08236	80-105	20

EN Self-adjustable oil filters pliers
 PL Szczypce samonastawne do filtrów oleju
 DE Selbsteinstellende Zangen für Ölfilter
 RU Саморегулирующиеся клещи для масляного фильтра
 CZ Samonastavovací kleště pro olejové filtry
 HU Önbeállító olajszűrő leszedő fogó
 RO Cheie ajustabilă filtru ulei
 FR Pince à filtre à huile auto-ajustable
 IT Pinza auto-regolante per filtri d'olio
 ES Pinzas autoajustables para filtros de aceite
 CN 滤清器扳手





60-120 mm 280 mm ADJUSTABLE NASTAWNY

YATO 	Ø [mm]	L [mm]	
YT-08231	60-120	280	6/36

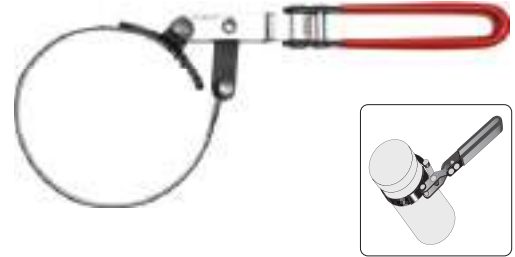
EN Oil filter wrench
 PL Klucz do filtra oleju
 DE Ölfilterschlüssel
 RU Съёмник масляного фильтра
 CZ Klíč na olejový filtr
 HU Olajszűrő leszedő
 RO Cheie pt. filtru de ulei
 FR Clé pour filtre à huile
 IT Chiave per filtro olio
 ES Llave para filtro de aceite
 CN 滤清器扳手





YATO 	Ø [mm]	
YT-0820	60-73	12/48
YT-0821	73-85	12/48
YT-0822	85-95	12/48
YT-0823	95-111	12/48

EN Belt oil wrench
 PL Klucz taśmowy do filtrów oleju
 DE Ölfilterschlüssel mit Riemen
 RU Ключ тросовый для масляных фильтров
 CZ Klíč na olejové filtry
 HU Olajszűrő leszedő

RO Cheie filtru cu banda
 FR Clé au filtre d'huile
 IT Chiave a nastro per filtro olio
 ES Llave de cinta para filtros de aceite
 CN 皮带钳扳手







YATO 	Ø [mm]	
YT-0824	80-160	6/60
YT-0825	100-200	5/20

EN Oil filter wrench
 PL Klucz do filtra oleju
 DE Ölfilterschlüssel
 RU Съёмник масляного фильтра
 CZ Klíč na olejový filtr
 HU Olajszűrő leszedő
 RO Cheie pt. filtru de ulei
 FR Clé pour filtre à huile
 IT Chiave per filtro olio
 ES Llave para filtro de aceite
 CN 滤清器扳手

2.5"-4" 63-120 mm 3/8" 9.5mm 1/2" 12.7mm HRC 40-50 CrV



YATO 	
YT-0826	12/36

EN Fuel filter socket
 PL Nasadka do filtra paliwa
 DE Aufsatz für Kraftstofffilter
 RU Крышка для топливного фильтра
 CZ Násada do palivového filtru
 HU Üzemanyagszűrő fedél kulcs
 RO Cheie pt. filtru combustibil
 FR Douille pour filtre à carburant
 IT Attacco per filtro del carburante
 ES Vaso para filtro de combustible
 CN 燃油过滤器套筒



1/2" 12.7mm 27 mm CrV FOR FUEL FILTER DO FILTRA PALIWA



YATO 	Ø	
YT-12000	1/2" (12.5 mm)	20/40

EN Haldex filter service tool
 PL Klucz specjalny do filtra haldex
 DE Spezialschlüssel für Haldex-Filter
 RU Специальный ключ для фильтра haldex
 CZ Speciální klíč do filtru haldex
 HU Speciális kulcs haldex szűrőhöz

RO Instrument service filtru haldex
 FR Clé pour filtre haldex
 IT Chiave filtro olio per frizione haldex
 ES Llave especial para el filtro haldex
 CN 差速器滤芯板

Ø 46 mm 390 mm CrMo VAG HALDEX



YATO 	L [mm]	
YT-05971	390	10/20

EN Cap type oil filter wrench set
PL Zestaw kluczy nasadowych do filtra oleju
DE Steckschlüsselsatz für Ölfilter
RU Набор торцовых ключей к масляному фильтру
CZ Sada miskovitých klíčů na olejové filtry
HU Dugókulcs készlet olajsűrőhöz
RO Set de chei tubulare pt. filtru de ulei
FR Set d'embouts aux filtres d'huile
IT Set di chiavi filtro olio
ES Juego de llaves de tubo para el filtro de aceite
CN 碗型滤清器扳手组套

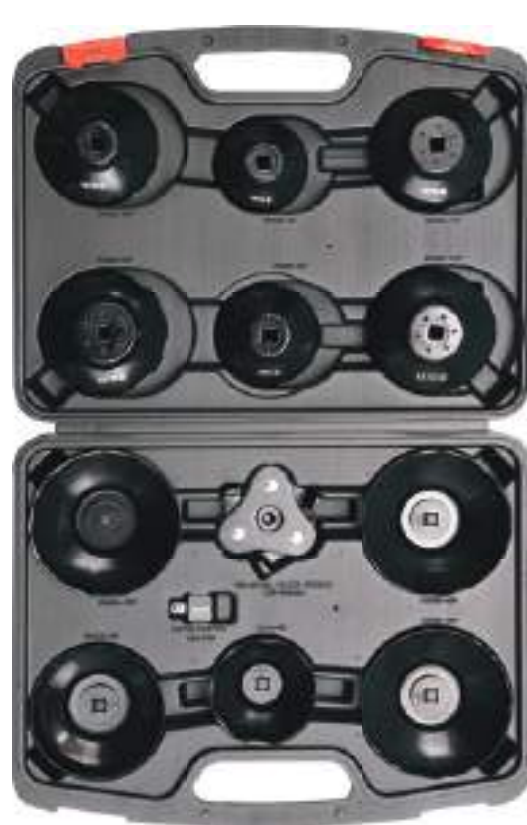
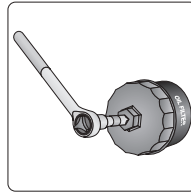

13
PCS

65-120
mm

3/8"
9.5 mm

1/2"
12.7 mm



number numer	size rozmiar	layers warstwy	grooves bruzdy	faces powierzchnie	car models modele samochodu
66/6	SW66	1	6		Fiat Punto 1.2, Renault Clio 1.2, Rapid, Twingo
76/8	SW76	1	8		Fiat, Lancia
76/12	SW76	1		12	Fiat, Mercedes, Renault
86/16	SW86	1		16	Volvo
86/18	SW86	1		18	VW Golf, Audi A6 TDI, Peugeot, Citroen
92/10	SW92	1		10	Fiat
93/45	SW93	1	45		VW, Audi TDI
96/18	SW96	1	18		Audi A4, A6 TDI, VQ Passat TDI, Renault Laguna
106/15	SW106	1		15	Fiat Ducato
108/15	SW108	1		15	Volvo
108/18	SW108	1	18		Renault Espace, Laguna, Safrane, Traffic

YATO 
YT-0594

5

EN Cap type oil filter wrench set
PL Zestaw kluczy nasadowych do filtra oleju
DE Steckschlüsselsatz für Ölfilter
RU Набор торцовых ключей к масляному фильтру
CZ Sada miskovitých klíčů na olejové filtry
HU Dugókulcs készlet olajsűrőhöz
RO Set de chei tubulare pt. filtru de ulei
FR Set d'embouts aux filtres d'huile
IT Set di chiavi filtro olio
ES Juego de llaves de tubo para el filtro de aceite
CN 碗型滤清器扳手组套

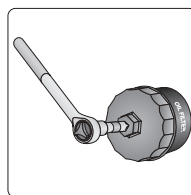

30
PCS

3/8"
9.5 mm



number numer	size rozmiar	layers warstwy	grooves bruzdy	faces powierzchnie	car models modele samochodu
66/6	SW66	1	6		Fiat Punto 1.2, Renault Clio 1.2, Rapid, Twingo
65/14	SW65	1		14	Daihatsu, Toyota, Nissan, Fiat
65/67	SW65-67	1		14	Daihatsu, Toyota
68/14	SW68	1		14	Mazda, Ford, Subaru
73/14	SW73	1		14	Toyota, Lexus
74/15	SW74	1		15	Audi, Rover, Chrysler
74/76	SW74-76	2		15	Ford, Opel, VW, Audi, Mercedes
75/77	SW75-77	2		15	VW, Audi, Isuzu, Mercedes
76/12	SW76	1		12	Fiat, Mercedes, Renault
76/14	SW76	1		14	VW, Porsche, Mercedes, BMW, Audi, Opel
76/30	SW76	1	30		Ford
76/8	SW76	1	8		Fiat, Lancia
78/15	SW78	1		15	Nissan, Ford, Toyota
80/15	SW80	1		15	Nissan, Honda, Opel, Mazda
80/82	SW80-82	2		15	Subaru, Toyota, Honda, Nissan
86/16	SW86	1		16	Volvo
86/18	SW86	1		18	VW Golf, Audi A6 TDI, Peugeot, Citroen
90/15	SW90	1		15	Honda, Mitsubishi, Isuzu
92/10	SW92	1		10	Fiat
93/15	SW93	1		15	Mazda, Volvo, Mitsubishi, Nissan, Honda
93/36	SW93	1	36		Ford
93/45	SW93	1	45		VW, Audi TDI
95/15	SW95	1	15		Toyota, Alfa Romeo, Ford
96/18	SW96	1	18		Audi A4, A6 TDI, VQ Passat TDI, Renault Laguna
100/15	SW100	1		15	Isuzu, Mitsubishi
106/15	SW106	1		15	Fiat Ducato
108/15	SW108	1		15	Volvo
108/18	SW108	1	18		Renault Espace, Laguna, Safrane, Traffic

YATO 
YT-0596

3

- EN Square oil drain plug wrench
 PL Klucz do korków spustowych oleju
 DE Schlüssel für Ölablassschraube
 RU Ключ для масляной пробки
 CZ Klíč do spouštěcích zátek oleje
 HU Olajleeresztő csavar kulcs
- RO Cheie pt. buşon ulei
 FR Clé pour bouchons de vidange d'huile
 IT Chiave per tappo di scarico olio
 ES Llave para tapones de descarga de aceite
 CN 方形放油塞扳手



8mm
 10mm
 PEUGEOT RENAULT VOLVO

Peugeot, Renault, Volvo

YATO
 YT-05995 6/36

- EN Plastic oil plug driver set
 PL Komplet kluczy do plastikowych korków oleju
 DE Schlüsselset für Plastikölstopfen
 RU Набор ключей для пластиковых масляных пробок
 CZ Sada klíčů na plastové olejové zátky
 HU Kulcskészlet műanyag olajleeresztő dugókhoz
 RO Set chei pt. buşon ulei de plastic
 FR Clés universelles pour bouchons de vidange d'huile en matière plastique
 IT Set di chiavi per tappi olio in plastica
 ES Juego de llaves para tapones de plástico para aceite
 CN 塑料油塞扳手组

5 PCS **3/8"** 9.5 mm PLASTIC OIL PLUGS PLASTIKOWE KORKI OLEJU



BMW, Ford, PSA, VAG

YATO
 YT-05980 20/40

- EN Oil drain plug key set
 PL Komplet kluczy do korków oleju
 DE Ölablassschrauben-Schlüssel-Satz
 RU Комплект ключей для сливной пробки
 CZ Klíče nástrčné na zátky olejových van motorů
 HU Olajleeresztő kulcs készlet
- RO Set chei pt. buşon ulei
 FR Ensemble de clés de bouchon de vidange d'huile
 IT Set di chiavi a bussola
 ES Juego de llaves para tapones de aceite
 CN 油底壳螺丝组套

6 PCS **3/8"** 9.5 mm

CrV



- 8, 3/8", 10, 12, 1/2", 14 mm;
 3/8" (9.5 mm), 1/2" (12.7 mm)

YATO
 YT-05997 10/40

- EN Oil pan drain plug removal set
 PL Zestaw do obsługi korków spustowych oleju
 DE Ölablassschrauben-Schlüssel-Satz
 RU Комплект для откручивания масляных пробок
 CZ Sada pro demontáž vypouštěcí zátky olejové vany
 HU Olajleeresztő dugó kezelő készlet
 RO Kit demontare a dopului de scurgere a baii de ulei
 FR Kit d'entretien de bouchons de vidange d'huile
 IT Kit per la rimozione di tappi per olio
 ES Juego para extraer tapones de drenaje de aceite
 CN 塑料油底壳拆装工具

6 PCS **VAG** PLASTIC OIL PLUGS PLASTIKOWE KORKI OLEJU



VAG

YATO
 YT-05994 12/72

- EN Oil drain plug key set
 PL Komplet kluczy do korków oleju
 DE Ölablassschrauben-Schlüssel-Satz
 RU Комплект ключей для сливной пробки
 CZ Klíče nástrčné na zátky olejových van motorů
 HU Olajleeresztő kulcs készlet
- RO Set chei pt. buşon ulei
 FR Ensemble de clés de bouchon de vidange d'huile
 IT Set di chiavi a bussola
 ES Juego de llaves para tapones de aceite
 CN 排油塞旋具组套

18 PCS **3/8"** 9.5 mm

CrV 50BV30



- 3/8" (9.5 mm): 7, 8, 10, 11, 12, 13, 14 mm;
 5/16" (7.9 mm), 3/8" (9.5 mm);
 3/8" (9.5 mm): 8, 9, 10, 12, 14, 17 mm;
 3/8" (9.5 mm): 10 mm;
 3/8" (9.5 mm): M16;
 3/8" (9.5 mm): 10 mm

YATO
 YT-05991 5/10

EN Oil drain plug set
PL Komplet kluczy do korków oleju
DE Ölablassschrauben-Schlüssel-Satz
RU Комплект ключей для сливной пробки
CZ Klíče nástrčné na zátky olejových van motorů
HU Olajleeresztő kulcs készlet

RO Set chei pt. bușon ulei
FR Ensemble de clés de bouchon de vidange d'huile
IT Set di chiavi a bussola
ES Juego de llaves para tapones de aceite
CN 排油塞旋具组套

18
PCS

3/8"
9.5 mm

CrV



- 3/8" (9.5 mm): 7, 8, 10, 11, 12, 13, 14 mm;
- 5/16" (7.9 mm), 3/8" (9.5 mm);
- 3/8" (9.5 mm): 8, 9, 10, 12, 14, 17 mm;
- 3/8" (9.5 mm): 10 mm;
- 3/8" (9.5 mm): 10 mm; 3/8" (9.5 mm): 160 mm

YATO ○
YT-0599 3/8" (9.5 mm) 10

EN Grease gun
PL Smarownica ręczna
DE Handhebel-Fettpresse
RU Шприц для смазки ручной
CZ Maznice páková
HU Karos zsírzó

RO Pistol de gresat
FR Pompe à graisse manuelle
IT Ingrassatore manuale
ES Pistola de engrase manual
CN 手动黄油枪

70
MPa
(max.)

31
MPa

500
cm³

AI



YATO ○
YT-0700 20

EN Grease gun
PL Smarownica ręczna
DE Handhebel-Fettpresse
RU Шприц для смазки ручной
CZ Maznice páková
HU Karos zsírzó

RO Pistol de gresat
FR Pompe à graisse manuelle
IT Ingrassatore manuale
ES Pistola de engrase manual
CN 手动黄油枪

70
MPa
(max.)

31
MPa

400
cm³

AI



YATO ○
YT-0705 20

EN Grease gun
PL Smarownica ręczna
DE Handhebel-Fettpresse
RU Шприц для смазки ручной
CZ Maznice páková
HU Karos zsírzó
RO Pistol de gresat
FR Pompe à graisse manuelle
IT Ingrassatore manuale
ES Pistola de engrase manual
CN 手动黄油枪

27-41
MPa

600
cm³

AI



YATO ○
YT-07042 6/12

EN Oil drain plug key set
PL Komplet kluczy do korków oleju
DE Ölablassschrauben-Schlüssel-Satz
RU Комплект ключей для сливной пробки
CZ Klíče nástrčné na zátky olejových van motorů
HU Olajleeresztő kulcs készlet

RO Set chei pt. bușon ulei
FR Ensemble de clés de bouchon de vidange d'huile
IT Set di chiavi a bussola
ES Juego de llaves para tapones de aceite
CN 排油塞组套

12
PCS

3/8"
9.5 mm

CrV



- 3/8" (9.5 mm): 8, 11, 13 mm;
- 3/8" (9.5 mm): 8, 9, 10, 12, 14, 17 mm

YATO ○
YT-0600 3/8" (9.5 mm) 10

EN Grease gun
PL Smarownica ręczna
DE Handhebel-Fettpresse
RU Шприц для смазки ручной
CZ Maznice páková
HU Karos zsírzó
RO Pistol de gresat
FR Pompe à graisse manuelle
IT Ingrassatore manuale
ES Pistola de engrase manual
CN 手动黄油枪

70
MPa
(max.)

31
MPa

120
cm³

AI



YATO ○
YT-0701 30

EN Grease gun
PL Smarownica ręczna
DE Handhebel-Fettpresse
RU Шприц для смазки ручной
CZ Maznice páková
HU Karos zsírzó

RO Pistol de gresat
FR Pompe à graisse manuelle
IT Ingrassatore manuale
ES Pistola de engrase manual
CN 手动黄油枪

70
MPa
(max.)

31
MPa

600
cm³

AI



YATO ○
YT-07044 6

EN Grease gun
PL Smarownica ręczna
DE Handhebel-Fettpresse
RU Шприц для смазки ручной
CZ Maznice páková
HU Karos zsírzó
RO Pistol de gresat
FR Pompe à graisse manuelle
IT Ingrassatore manuale
ES Pistola de engrase manual
CN 手动黄油枪

27-41
MPa

800
cm³

AI



YATO ○
YT-07043 4/8

EN Two-way operation grease gun
 PL Smarownica ręczna, wzmocniona
 DE Handhebel-Fettpresse
 RU Шприц для масляной смазки
 CZ Páková maznice
 HU Karos zsírzó

RO Masina de gresat cu furtun rigid
 FR Pistolet de graissage manuel
 IT Lubrificatore manuale
 ES Pistola de engrase
 CN 重型黄油枪

70 MPa (max.)
42 MPa
500 cm³
AI



YATO **YT-0704** 12

EN Two-way operation grease gun
 PL Smarownica ręczna, wzmocniona
 DE Handhebel-Fettpresse
 RU Шприц для масляной смазки
 CZ Páková maznice
 HU Karos zsírzó

RO Masina de gresat cu furtun rigid
 FR Pistolet de graissage manuel
 IT Lubrificatore manuale
 ES Pistola de engrase
 CN 重型黄油枪

70 MPa (max.)
42 MPa
500 cm³
AI



YATO **YT-07041** 10

EN Grease gun
 PL Smarownica ręczna
 DE Handhebel-Fettpresse
 RU Шприц для смазки ручной
 CZ Maznice páková
 HU Karos zsírzó
 RO Pistol de gresat
 FR Pompe à graisse manuelle
 IT Ingrassatore manuale
 ES Pistola de engrase manual
 CN 手动黄油枪

55 MPa (max.)
24.8 MPa
400 cm³
AI



YATO **YT-07045** 6

EN Grease gun
 PL Smarownica ręczna
 DE Handhebel-Fettpresse
 RU Шприц для смазки ручной
 CZ Maznice páková
 HU Karos zsírzó

RO Pistol de gresat
 FR Pompe à graisse manuelle
 IT Ingrassatore manuale
 ES Pistola de engrase manual
 CN 手动黄油枪

69 MPa (max.)
27.6 MPa
400 cm³
AI



YATO **YT-07046** 8

EN Extraction & fill pump
 PL Odsysarka ręczna do płynów eksploatacyjnych
 DE Manuelle Absaugvorrichtung für Betriebsflüssigkeiten
 RU Ручной отсос для рабочих жидкостей
 CZ Ruční odsávací zařízení provozních kapalin
 HU Kézi üzemi folyadék elszívó

RO Pompa pt. extras si umplut
 FR Appareil portable de vidange par aspiration
 IT Aspiratore manuale per liquidi
 ES Dispositivo de succión manual
 CN 抽油泵

200 ml

 FOR OPERATIONAL LIQUIDS
 DO PLYNŃW
 EKSPLOATACYJNYCH



YATO **YT-07083** 24

EN Extraction & fill pump
 PL Odsysarka ręczna do płynów eksploatacyjnych
 DE Manuelle Absaugvorrichtung für Betriebsflüssigkeiten
 RU Ручной отсос для рабочих жидкостей
 CZ Ruční odsávací zařízení provozních kapalin
 HU Kézi üzemi folyadék elszívó

RO Pompa pt. extras si umplut
 FR Appareil portable de vidange par aspiration
 IT Aspiratore manuale per liquidi
 ES Dispositivo de succión manual
 CN 抽加油壶

500 ml

 FOR OPERATIONAL LIQUIDS
 DO PLYNŃW
 EKSPLOATACYJNYCH



YATO **YT-07084** 20

EN Oil transfer pump
 PL Pompa transferowa do oleju
 DE Öl-Umfüllpumpe
 RU Шприц для перекачки масла
 CZ Ruční olejová pumpa
 HU Olajpumpa

RO Pompa de ulei de mana
 FR Pompe pour huile
 IT Lubrificatore manuale per travaso olio
 ES Bomba manual de trasvase dual
 CN 输油泵

70 MPa (max.)
31 MPa
500 cm³



YATO **YT-0707** 20

EN Oil drainer
 PL Odsysarka ręczna do oleju
 DE Öl-Absaugpumpe
 RU Ручной шприц для откачки масла
 CZ Ruční odsávacíka oleje
 HU Kézi olajszívattyú

RO Pompa de ulei
 FR Seringue à huile
 IT Lubrificatore manuale per aspirazione olio
 ES Bomba manual de trasvase
 CN 输油泵

70 MPa (max.)
31 MPa
500 cm³



YATO **YT-0708** 20

EN Grease gun adaptors set
PL Zestaw końcówek do smarownic
DE Mundstücksatz für Fettpressen
RU Набор наконечников для смазочного шприца
CZ Sada koncovek pro maznice
HU Olajózó fejkészlet
RO Set adaptoare pt. gresoare
FR Jeu d'accessoires pour pompes à graisse
IT Kit di nipples per ingrassatori
ES Juego de puntas para engrasadores
CN 黄油嘴配件套装

7 PCS 38 cm 90° 180° 360° UNIVERSAL UNIVERSAL



EN Grease coupler
PL Glowica do smarownicy
DE Fettpressenkopf
RU Головка для пресс-масленки
CZ Hlavice do maznice
HU Olajózó fej
RO Cupla pt. pistol de gresat
FR Tête de graisseur
IT Testa per lubrificatore
ES Cabezal para engrasador
CN 高压油嘴头

15 mm G26



YATO		
YT-07110		10

YATO	Ø [mm]	
YT-07102	15	18/72

EN Multi-use transfer pump
PL Pompa transferowa do płynów
DE Übertragungspumpe für Flüssigkeiten
RU Перекачивающий насос для жидкостей
CZ Přečerpávací čerpadlo na kapaliny
HU Átvívó szivattyú folyadékokhoz

RO Pompa de transfer multifunctionala
FR Pompe de transfert de liquides
IT Pompa di trasferimento per liquidi
ES Bomba de transferencia de líquidos
CN 打气筒

170 ml FOR OPERATIONAL LIQUIDS 30 FLUID OZ (ESP/OPACIYAVCH) PUMP FUNCTION FUNKCJA POMPKI PVC PP



YATO	[ml]	
YT-07071	170	6/24

EN Manual hand pump
PL Odysarka ręczna do płynów eksploatacyjnych
DE Handabsauger für Betriebsflüssigkeiten
RU Ручной инструмент для всасывания рабочих жидкостей
CZ Ruční odsávací zařízení provozních kapalin
HU Kézi szivattyú üzemi folyadékokhoz
RO Pompa manuala
FR Pompe d'aspiration manuelle de fluides
IT Aspiratore manuale per liquidi
ES Bomba manual para fluidos de trabajo
CN 抽油泵

1.5L FOR OPERATIONAL LIQUIDS 30 FLUID OZ (ESP/OPACIYAVCH)



Opel, PSA

YATO		
YT-07082		20

EN Grease pump
PL Smarownica ręczna
DE Manuelle fettumpen
RU Шприц для смазки

CZ Maznice ruční
HU Kézi zsírozó pumpa
RO Grăsimă manual pompa
FR Pistolet de graissage manuel

IT Pompe manuali per grasso
ES Grasa manual de la bomba
CN 黄油泵

1.5 m



13.8 MPa (max.) 4 kg



13.8 MPa (max.) 8 kg



20.5 MPa (max.) 16 kg

YATO	Grease tank capacity / Pojemność zbiornika smaru [kg]	
YT-07061	4	1

YATO	Grease tank capacity / Pojemność zbiornika smaru [kg]	
YT-07063	8	1

YATO	Grease tank capacity / Pojemność zbiornika smaru [kg]	
YT-07065	16	1

EN Flexible tube for grease gun
PL Wężyk do towotnicy
DE Schlauch für Fettpresse
RU Шприц для перекачки масел
CZ Hadička na maznice na šmír
HU Tömli a zsírozóhoz

RO Furtun flexibil pt. pistol de gresat
FR Flexible pour graisseur
IT Tubo flessibile per ingrassatore
ES Manguera para engrasador
CN 手持黄油枪软管

3.2 mm



YATO	L [mm]	
YT-0709	300	12/144
YT-0710	500	12/144

EN Flexible hose for grease gun
PL Wężyk do towotnicy
DE Fettpressenschlauch
RU Шланг для тавотницы
CZ Hadička do vazelíny
HU Cső zsírozóhoz

RO Tub flexibil pt. pistol de gresat
FR Flexible pour graisseur
IT Tubo flessibile per ingrassatore
ES Manguera para engrasador
CN 高压尼龙软管

69 MPa (max.) 440 mm G26



YATO	L [mm]	
YT-07101	440	9/36

EN Oiler with a flexible applicator
 PL Oliwiarka z elastycznym aplikatorem
 DE Ölkanne mit elastischem Applikator
 RU Масленка с гибким аппликатором
 CZ Olejníčka s ohebným aplikátorem
 HU Hajlékony csövű olajozó
 RO Gresor cu aplicator flexibil
 FR Burette à huile
 IT Lubrificante con canna flessibile
 ES Aceitera con aplicador flexible
 CN 油壺



200 ml

IMPACT RESISTANT COPRINY NA UDERZENIA

YATO	V [cm ³]	
YT-0690	220	10/120
YT-0691	270	10/120

YATO	V [ml]	
YT-06912	200	10/120



300 ml

IMPACT RESISTANT COPRINY NA UDERZENIA

YATO	V [ml]	
YT-06913	300	10/120



500 ml

IMPACT RESISTANT COPRINY NA UDERZENIA

YATO	V [ml]	
YT-06914	500	10/80

EN Precision oiler
 PL Oliwiarka precyzyjna
 DE Präzisionsöler
 RU Прецизионная масленка
 CZ Přesná olejníčka
 HU Precíz olajozó
 RO Gresor de precizie
 FR Graisseur de précision
 IT Oliatore di precisione
 ES Aceitera de precisión
 CN 润滑油笔



15 ml

150 mm

AI



YATO	V [ml]	
YT-06977	15	12/120

EN Engine oil filler set
 PL Lejek do wlewania oleju z adapterami
 DE Ölfüller-Set
 RU Воронка для моторного масла с адаптерами
 CZ Sada pro plnění motorového oleje
 HU Olajfeltöltő adapter
 RO Palnie cu adaptor pt. capacul de ulei
 FR Adaptateur de remplissage d'huile aide avec entonnoir
 IT Imbuto per versare olio con adattatori
 ES Automotiv embudo de llenado de aceite
 CN 加油漏斗组套



15 PCS

2L

FOR TIGHT SPACES DO CIĄSNYCH PRZESTRZENIACH



YATO	
YT-06919	4

EN Oil pump
 PL Pompa tłokowa do oleju
 DE Öl-Umfüllpumpe
 RU Шприц ручной заливной
 CZ Ruční olejová pumpa
 HU Olajpumpa
 RO Pompa de ulei de mana
 FR Pompe pour huile
 IT Pompa manuale travaso fusti olio
 ES Bomba manual para aceite
 CN 吸油泵



16-18 l/min

45-90 cm

max 55 min⁻¹

0.31 CYCLE CYKL

AI

FOR OIL DO OLEJU



YATO	
YT-0712	10

EN Aluminium rotary oil pump
 PL Aluminiowa pompa do oleju
 DE Aluminium-Kurbelpumpe
 RU Алюминиевый ручной бочковой насос
 CZ Hliník rotační čerpadlo
 HU Alumínium rotációs szivattyú
 RO Aluminiu pompă rotativă
 FR Pompe manuelle pour huile
 IT Pompa a mano per olio
 ES Aluminio bomba rotary
 CN 手摇油泵



21 l/min

500 cm

300 cm

x3 PIPE RURA

AI

FOR OIL DO OLEJU



YATO	
YT-07115	10

EN High value rotary barrel pump
 PL Wysokowydajna pompa rotacyjna do paliwa
 DE Kurbelpumpe für Benzfässer
 RU Насос топливный ротационный
 CZ Čerpadlo palivové rotační
 HU Kézi pumpa hordóhoz (forgatható)
 RO Pompa rotativa pt. combustibil
 FR Pompe rotative à combustible
 IT Pompa rotativa travaso gasolio
 ES Bomba de combustible rotatoria
 CN 手摇泵



100 l/min

100 cm

1.01 CYCLE CYKL

180µm BRASS FILTER MOSEZŰVY FÉLTŰ

2.4m ANTÉNYE HÍBE NÁZKŰVY FÉLTŰ

AI

FOR FUELS AND OIL DO PALÍV I OLEJU



YATO	
YT-0715	4

EN Two arms jaw puller RU Съёмник для подшипников RO Extractor rulmenti ES Extractor
PL Ściągacz dwuramienny CZ Stahovák FR Extracteur CN 两爪拉马
DE Abzieher-2-armig HU Csapágylehúzó IT Estrattore

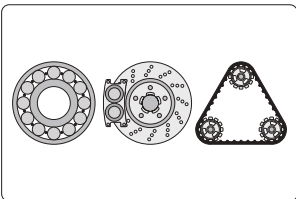

10 mm
4"
100 mm
max Ø
60 mm
max
1.2t



10 mm
3"
76 mm
max Ø
75 mm
max
1.1t



YATO	Height [mm]	Width [mm]	max. Ø [mm]	max. [t]	Box icon
YT-2514	10	100	60	1.2	6/60

YATO	Height [mm]	Width [mm]	max. Ø [mm]	max. [t]	Box icon
YT-2515	10	76	75	1.1	6/60

12 mm
4"
100 mm
max Ø
100 mm
max
1.4t



17 mm
6"
150 mm
max Ø
120 mm
max
6t



22 mm
8"
200 mm
max Ø
180 mm
max
9t



YATO	Height [mm]	Width [mm]	max. Ø [mm]	max. [t]	Box icon
YT-2516	12	100	100	1.4	12/48

YATO	Height [mm]	Width [mm]	max. Ø [mm]	max. [t]	Box icon
YT-2517	17	150	120	6	10/20

YATO	Height [mm]	Width [mm]	max. Ø [mm]	max. [t]	Box icon
YT-2518	22	200	180	9	6

EN Three arms jaw puller RU Съёмник для подшипников RO Extractor rulmenti cu trei brate ES Extractor detres patas
PL Ściągacz trójramienny CZ Stahovák třiramenný FR Extracteur CN 三爪拉马
DE Abzieher-3-armig HU Csapágylehúzó IT Estrattore

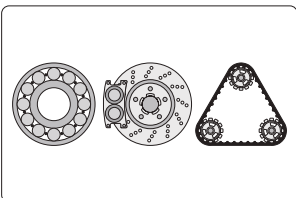

10 mm
3"
76 mm
max Ø
80 mm
max
1.5t



12 mm
4"
100 mm
max Ø
100 mm
max
2.5t



YATO	Height [mm]	Width [mm]	max. Ø [mm]	max. [t]	Box icon
YT-2519	10	76	80	1.5	6/60

YATO	Height [mm]	Width [mm]	max. Ø [mm]	max. [t]	Box icon
YT-2520	12	100	100	2.5	6/36

17 mm
6"
150 mm
max Ø
130 mm
max
5t



22 mm
8"
200 mm
max Ø
180 mm
max
9t



22 mm
12"
300 mm
max Ø
180 mm
max
11t



YATO	Height [mm]	Width [mm]	max. Ø [mm]	max. [t]	Box icon
YT-2521	17	150	130	5	12

YATO	Height [mm]	Width [mm]	max. Ø [mm]	max. [t]	Box icon
YT-2522	22	200	180	9	4

YATO	Height [mm]	Width [mm]	max. Ø [mm]	max. [t]	Box icon
YT-2523	22	300	180	11	2

EN Three arms jaw puller
 PL Ściągacz trójramienny
 DE Abzieher-3-armig
 RU Съёмник для подшипников

CZ Stahovák tříramenný
 HU Csapágyelhúzó
 RO Extractor rulmenți cu trei brate
 FR Extracteur

IT Estrattore
 ES Extractor detres patas
 CN 三爪拉马

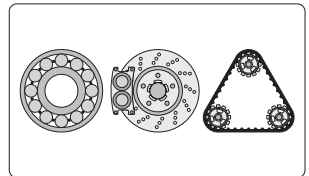

14 mm 3" 50-150 mm



15 mm 4" 60-200 mm



19 mm 6" 80-300 mm

YATO	W [mm]	L [mm]	Ø [mm]	Pcs
YT-2511	14	76	50-150	20

YATO	W [mm]	L [mm]	Ø [mm]	Pcs
YT-2512	15	100	60-200	20

YATO	W [mm]	L [mm]	Ø [mm]	Pcs
YT-2513	19	150	80-300	10

EN Universal puller set
 PL Ściągacz do łożysk w miejscach trudnodostępnych
 DE Abziehvorrichtung für Lager
 RU Съёмник подшипников в труднодоступных местах
 CZ Sada na stahování ložisek na obtížně dostupných místech
 HU Csapágyelhúzó
 RO Trăgător pt. rulmenți în locuri greu accesibile
 FR Extracteur aux roulements
 IT Set di estrattori universali
 ES Extractor de rodamientos en lugares de difícil acceso
 CN 多功能拉拔器

12 PCS DROP FORGED KUTE FOR TIGHT SPACES DO ČASŤNÝCH PRŤZESTŘENÍ

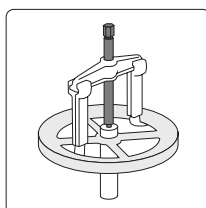
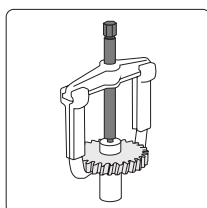
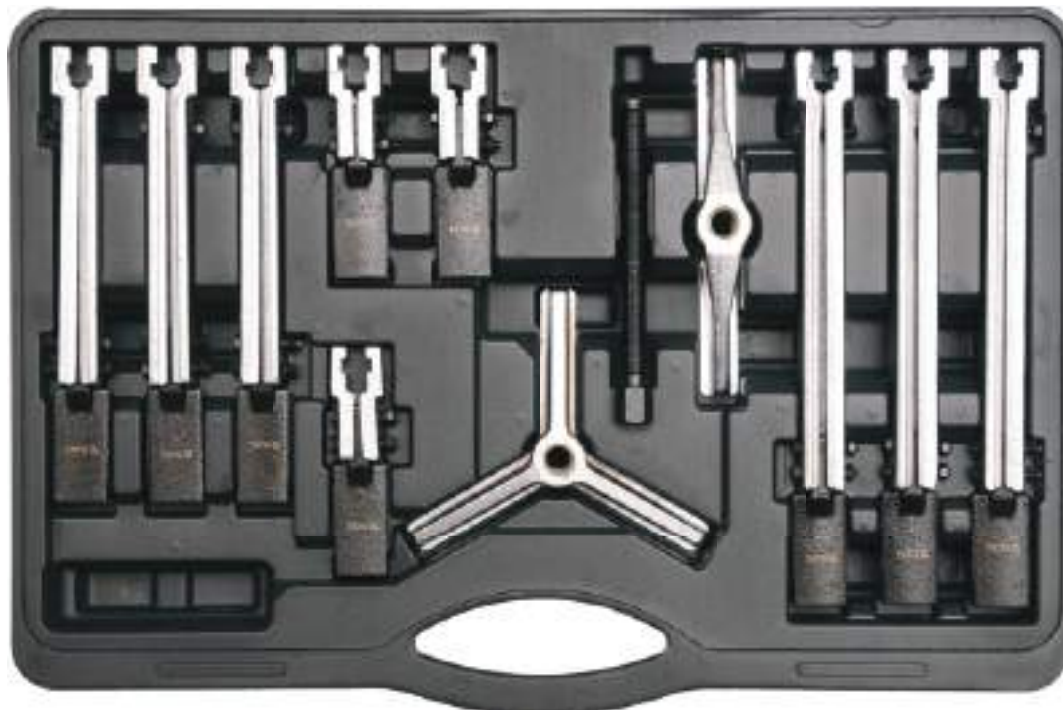

- 3 x 250 mm;
- 3 x 200 mm;
- 3 x 100 mm;
- 160 mm;
-

YATO	Pcs
YT-25105	2

EN Pilot bearing puller
PL Ściągacz do łożysk
DE Abzieher für Innenlager
RU Съемник внутренних подшипников
CZ Stahovák na ložiska vnitřní
HU Csapágyelhúzó
RO Clește interior pt. extras rulmenți
FR Extracteur intérieur aux roulements
IT Estrattore cuscinetti
ES Extractor de cojinetes inter
CN 轴承拉马

13-38 mm CrV 6150



YATO	Ø [mm]	
YT-2510	13-38	20

EN Separator and hydraulic cylinder turnbuckle
PL Separator i ściągacz z sitownikiem hydraulicznym
DE Separator und Abziehvorrichtung mit Hydraulikservomotor
RU Сепаратор и съемник с сервомотором
CZ Oddělovač a stahovák s hydraulickým válcem
HU Csapágyelhúzó és körmös csapágyelhúzó hidraulikus kézpumpával
RO Separator și ancoră cu servomotor hidraulic
FR Séparateur avec actionneur hydraulique
IT Separatore frizione cilindro idraulico
ES Separador y tensor de tornillo con cilindro hidráulico
CN 液压分离器组合

75-105 mm 24-250 mm 80-180 mm

50 kN HYDRAULIC CYLINDER SŁOWNIK HYDRAULICZNY

HRC 38-45 DROP FORGED KUTE

CrV

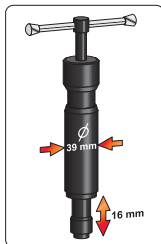

YATO	Force pressure / Siła nacisku [kN]	
YT-0609	50	2

EN Gear puller set
PL Ściągacz dwuramienny i separator
DE Lagerabzieher, Trennmesser
RU Съемник универсальный с сепаратором
CZ Stahovák dvouramenný
HU Csapágyelhúzó készlet
RO Set angrenaj pt. extras
FR Extracteur 2 bras + séparateur
IT Estrattore a due bracci a separatore
ES Kit de extractor
CN 齿轮拉拔器

35-150 mm max 43 mm

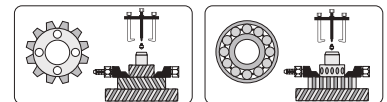
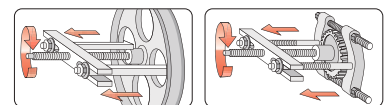
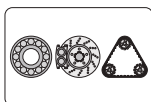

YATO	
YT-0641	4

EN Universal wheel hub puller
PL Ściągacz uniwersalny do tarcz i bębnow
DE Scheiben-und Trommelbremsen Abzieher
RU Универсальный съемник ступицы и полуоси
CZ Stahovák na brzdové bubny
HU Univerzális féktárcsa és fékdob leközö
RO Trusa universală pt. transmisie cardanica
FR Extracteur universel pour les disques et les tambours
IT Estrattore a vite universale
ES Extractor universal de discos y tambores
CN 万用轮毂拉马

90-140 mm 130-180 mm CrV

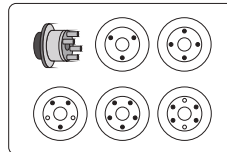

YATO	
YT-0602	6

EN Twin leg puller with jaw hook
PL Ściągacz uniwersalny dwuramienny
DE Doppel Abzieher mit Haken
RU Съемник универсальный
CZ Stahovák dvouramenný univerzální
HU Csapágyelhúzó készlet
RO Carlig cu falci pt. extras cu picor dublu
FR Extracteur universel à deux bras
IT Estrattore universale a due bracci
ES Extractor de cuatro patas
CN 单边两爪拉马

40-220 mm

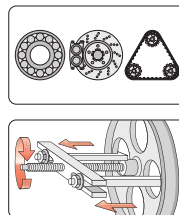

YATO	
YT-0640	10

- EN Gear puller set
- PL Ściągacz dwuramienny i separator
- DE Lagerabzieher, Trennmesser
- RU Съемник универсальный с сепаратором
- CZ Stahovák dvouarmenný
- HU Csapágyelhúzó készlet
- RO Set angrenaj pt. extras
- FR Extracteur 2 bras + separateur
- IT Estrattore a due bracci a separatora
- ES Kit de extractor
- CN 齿轮拉拔器



14 PCS	 35-130 mm
 max 60 mm	 max 75 mm

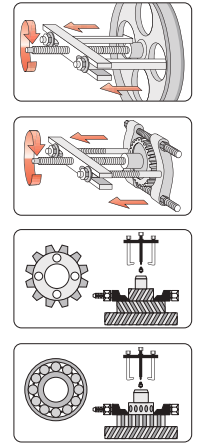

YATO	
YT-06412	2

- EN Slide hammer and bearing puller set
- PL Ściągacz bezwładnościowy do łożysk
- DE Träge Abziehvorrichtung für Lager
- RU Набор съемников с обратным молотком
- CZ Rázový stahovák s kluzným kladivem na ložiska
- HU Csúszósúlyos csapágyelhúzó készlet
- RO Set ciocan culisant extractor de rulmenti
- FR Extracteur de roulements à inertie
- IT Set estrattori interni / esterni
- ES Extractor de inercia para cojinetes
- CN 滑锤轴承拉拔器组套

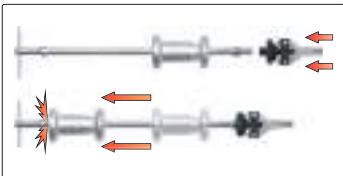

5 PCS	
-----------------	--

- | | | | |
|---|---|---|---|
| | | | |
| External 3-jaw puller
Ściągacz 3-ramienny zewnętrzny | External 2-jaw puller
Ściągacz 2-ramienny zewnętrzny | Internal 3-jaw puller
Ściągacz 3-ramienny wewnętrzny | Internal 2-jaw puller
Ściągacz 2-ramienny wewnętrzny |

YATO	
YT-2540	2

- EN Bearing extractor set
- PL Ściągacz bezwładnościowy do łożysk
- DE Trägheitsabziehvorrichtung für Lager
- RU Инерционный съемник подшипников
- CZ Stahovák kluzného ložiska
- HU Csúszó kalapácsos csapágyelhúzó
- RO Set extractor rulment
- FR Extracteur de roulements
- IT Kit estrattori cuscinetti
- ES Extractor de rodamientos por inercia
- CN 内轴承拉马

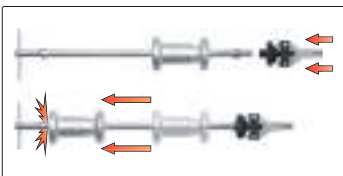

15 PCS	 8-58 mm
INTERNAL PULLER ŚCIAGACZ WEWNĘTRZNY	

YATO	
YT-25390	2

EN Slide hammer set
PL Ściągacz bezwładnościowy do piast i łożysk
DE Träge Abziehvorrichtung für Naben und Lager
RU Набор съёмников с обратным молотком
CZ Rázový stahovák s kluzným kladivem na náboje a ložiska
HU Csúszósúlyos kerékagy- és csapágyelhúzó készlet
RO Set ciocan cuilsant extractor de rulmenti și bușca
FR Extracteur de roulements et moyeux à inertie
IT Set estrattori per cuscinetti interno
ES Extractor de inercia para cubos y cojinetes
CN 滑锤

16
PCS

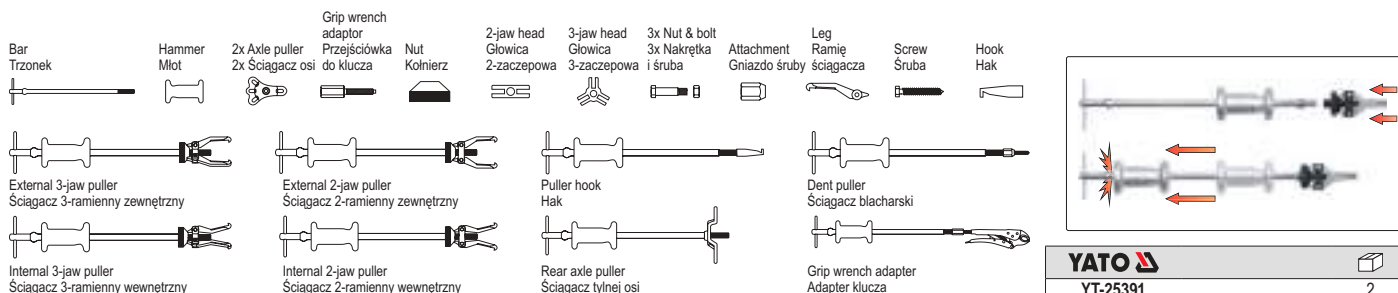

YATO
YT-25391 2

EN Front wheel bearing adapter set
PL Ściągacz łożysk piasty przedniej
DE Radlagerabzieher werkzeugsatz vorderachse
RU Набор для снятия переднего подшипника переднеприводных автомобилей
CZ Sada na demontáž ložisek přední nápravy
HU Csapágyelhúzó adapter készlet első futóműhöz

RO Set schimbat rulment roata fata
FR Extracteur de moyeux
IT Set estrattori per cuscinetti ruota anteriore adattatore universale
ES Extractor de cojinetes para cubos de rueda delanteros
CN 轴承拆装组套

23
PCS
FOR FRONT WHEEL BEARINGS AND BUSHINGS DO LOŻYSK I TULEJ

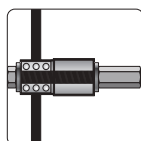

YATO
YT-2541 2

EN Wheel bearing bushing tool set
PL Zestaw do obsługi łożysk i tulei
DE Radlagerwerkzeug-Satz
RU Набор для обслуживания подшипников и втулок
CZ Sada pro údržbu ložisek a pouzder
HU Kerécsapágy persely szerszámkészlet

RO Set extractoare rulmenti
FR Kit d'outils pour l'installation et démontage du roulement
IT Kit per montaggio / smontaggio dei cuscinetti e manicotti
ES Juego de herramientas de cojinetes de rueda
CN 轴承安装工具

26
PCS
FOR BEARINGS AND BUSHINGS DO LOŻYSK I TULEJ



Ø 10, 12, 14, 16 mm (L=450 mm);
Yellow / Żółte: 46 x 36 mm, 58 x 48 mm, 70 x 60 mm, 82 x 72 mm, 44 x 34 mm, 56 x 46 mm, 68 x 58 mm, 80 x 70 mm, 54 x 44 mm, 66 x 56 mm, 78 x 68 mm;
Silver / Srebrne: 52 x 42 mm, 64 x 54 mm, 76 x 66 mm, 50 x 40 mm, 62 x 52 mm, 74 x 64 mm, 48 x 38 mm, 60 x 50 mm, 72 x 62 mm;
Ø (2 PCS)

YATO
YT-25411 1

EN Wheel bearing bushing tool set
PL Zestaw do obsługi łożysk i tulei
DE Radlagerwerkzeug-Satz
RU Набор для обслуживания подшипников и втулок
CZ Sada pro údržbu ložisek a pouzder
HU Kerécsapágy persely szerszámkészlet
RO Set extractoare rulmenti
FR Kit d'outils pour l'installation et démontage du roulement
IT Kit per montaggio / smontaggio dei cuscinetti e manicotti
ES Juego de herramientas de cojinetes de rueda
CN 轴承安装工具

31
PCS
38
mm
FOR BEARINGS AND BUSHINGS DO LOŻYSK I TULEJ

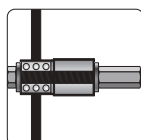

YATO
YT-25412 1

EN Ball joint separator tool kit
PL Prasa śrubowa do sworzni i tulei
DE Schraubenpresse für Bolzen und Buchsen
RU Винтовой пресс для штифтов и втулок
CZ Šroubovací lis pro čepy a pouzdra
HU Gömbcsukló ki-beszerező készlet
RO Kit extractor articulații cu bilă
FR Clé à douille universelle
IT Estrattore per perni e boccole
ES Prensa de husillo para pernos y casquillos
CN 球头拆卸组套

9
PCS
22
mm
130
mm
FOR PINS AND BUSHINGS DO SWORZNI I TULEJ

Ø 45/51 x 44 mm, Ø 57/63 x 44 mm; Ø 70/76 x 55 mm



YATO
YT-25413 1

EN Self-tightening pull clamp
 PL Klamra blacharska samozaciskowa
 DE Karosserie-Zugklemme
 RU Зажим для кузовных работ
 CZ Karosářská svěrka samosvorná k tahání
 HU Őnszorító húzóató pofa egyenes
 RO Clemă pt. tablă cu strângere automată
 FR Pince de traction de tirage pour carrosserie
 IT Pinza autosestante per riparazione carrozzeria
 ES Abrazadera de tiro para reparación de carrocería
 CN 窄型张引夹

5t **125 mm** **42x20mm** **AUTO TIGHTEN SAMC-ZACISKOWA**

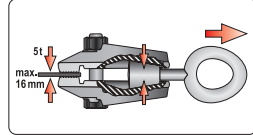

EN C-type self-tightening pull clamp
 PL Klamra blacharska samozaciskowa typu „C”
 DE Karosserie-Zugklemme Typ „C”
 RU Зажим для кузовных работ типа „C”
 CZ Karosářská svěrka samosvorná k tahání typ „C”
 HU Őnszorító húzóató pofa öblös
 RO Clemă pt. tablă cu strângere automată de tip „C”
 FR Pince de traction de tirage pour carrosserie type C
 IT Pinza autosestante per riparazione carrozzeria tipo „C”
 ES Abrazadera de tiro para reparación de carrocería tipo „C”
 CN 宽型张引夹

3t **142 mm** **35x15mm** **C TYPE** **AUTO TIGHTEN SAMC-ZACISKOWA**

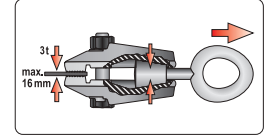

YATO L [mm]
 YT-2542 125 12

YATO L [mm]
 YT-2543 142 10

EN Twist socket set
 PL Zestaw wykrętek do śrub
 DE Schraubendrehersatz
 RU Набор для извлечения обломанных болтов
 CZ Sada vyťahováku stržených šroubů
 HU Törtcsavar kiszedő készlet

RO Set de chei pt. șuruburi
 FR Set d'extracteurs aux vis
 IT Set estrattori per dadi
 ES Juego de destornilladores
 CN 螺栓取出器组套

10 PCS **3/8" 9.5 mm** **HRC 52-55**

CrMo

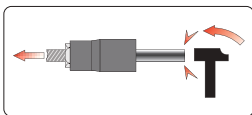

3/8" (9.5 mm): 10, 11, 12, 13, 14, 15, 16, 17, 19 mm;
 Ø 8 mm

YATO
 YT-0603 20

EN Twist socket set
 PL Zestaw wykrętek do śrub
 DE Schraubendrehersatz
 RU Набор для извлечения обломанных болтов
 CZ Sada vyťahováku stržených šroubů
 HU Törtcsavar kiszedő készlet

RO Set de chei pt. șuruburi
 FR Set d'extracteurs aux vis
 IT Set estrattori per dadi
 ES Juego de destornilladores
 CN 螺栓取出器组套

10 PCS **3/8" 9.5 mm**

CrMo

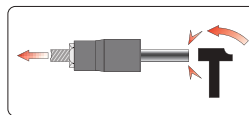

3/8" (9.5 mm): 9, 10, 11, 12, 13, 14, 15, 16, 17, 19 mm

YATO
 YT-06031 20

EN Twist socket set
 PL Zestaw wykrętek do śrub
 DE Schraubendrehersatz
 RU Набор для извлечения обломанных болтов
 CZ Sada vyťahováku stržených šroubů
 HU Törtcsavar kiszedő készlet
 RO Set de chei pt. șuruburi
 FR Set d'extracteurs aux vis
 IT Set estrattori per dadi
 ES Juego de destornilladores
 CN 螺栓取出器组套

6 PCS **1/2" 12.7 mm** **CrMo**

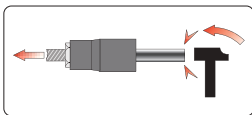

1/2" (12.5 mm): 17, 19, 21, 23, 27 mm;
 Ø 12 mm

YATO
 YT-06032 10

EN Screw extractor set & HSS drill bits
 PL Wykrętki do zerwanych śrub i wiertła do metalu HSS
 DE Schraubenausdrehsatz & HSS Bohrer
 RU Экстракторы и сверла по металлу HSS
 CZ Vrtáky do přetržených šroubů & vrtáky na kov HSS
 HU Törtcsavar kiszedő készlet + fúrószárak fémhez HSS
 RO Capete pt. deșurubat șuruburi rupte & burghie pt. metal HSS
 FR Set d'extracteurs aux vis
 IT Estrattori di vite HSS
 ES Destornillador para tornillos arrancados & HSS brocas
 CN 短丝取出器组套

12 PCS **M3-M24** **HSS**

No.	Ø [mm]	M	Ø [mm]
#1	1.4 - 3.6	3 - 6	1.8
#2	2.1 - 4.9	6 - 8	2.6
#3	3.1 - 6.5	8 - 11	3.7
#4	4.8 - 8.8	11 - 14	5.5
#5	6.2 - 11.0	14 - 18	7.0
#6	9.4 - 15.0	18 - 24	10.3



YATO
 YT-0591 40

EN Universal extractor set
PL Uniwersalny zestaw do wykręcania
DE Gewindeausdreh-Satz
RU Набор экстракторов для болтов и гаек
CZ Nástrojová sada pro poškozené šrouby a matice
HU Szerszámkészlet sérült csavarokhoz és anyákhoz
RO Set universal de extras suruburi
FR Extracteurs universels de vis et d'écrous
IT Set universale di cacciaviti
ES Juego de extractores tornillos rotos
CN 螺丝 螺杆, 螺母取出器组套

17 PCS
1/2" 12.7mm
3/8" 9.5mm
CrV 50BV30
CrMo 42

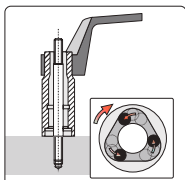

3/8" (9.5 mm): 9, 10, 11, 12, 13, 14, 16 (L=28); 19 mm (L=30); CrMo 42;
1/2" (12.5 mm): 6, 8 (L=60 mm); 10, 12 mm (L=70 mm); CrV 50BV30;
M3-M6, M6-M8, M8-M11, M11-M14, M14-M18; CrMo 42

YATO
YT-06033

10

EN Twist socket set
PL Zestaw wykrętek do śrub
DE Schraubendrehersatz
RU Набор для извлечения обломанных болтов
CZ Sada vyťahováku stržených šroubů
HU Törtcsavar kiszedő készlet
RO Set de chei pt. șuruburi
FR Set d'extracteurs aux vis
IT Set estrattori per dadi
ES Juego de destornilladores
CN 螺栓取出器组套

16 PCS
CrMo 42
HRC 47-50
72T

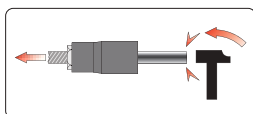

1/4", 8 mm, 3/8", 10 mm, 11 mm, 12 mm, 1/2", 13 mm,
14 mm, 16 mm, 17 mm, 11/16", 19 mm; CrMo 42;
3/8" (9.5 mm); 72T;
1/4" (6.3 mm) x 3/8" (9.5 mm);

YATO
YT-05897

10

EN Screw extractor set
PL Wykrętki do zerwanych śrub
DE Schraubenausdrehsatz
RU Набор для извлечения обломанных болтов
CZ Vrtáky do přetržených šroubů
HU Törtcsavar kiszedő készlet
RO Capete pt. desurubată șuruburi rupte
FR Set d'extracteurs aux vis
IT Estrattori di viti
ES Destornillador para tornillos arrancados
CN 断丝取出器

5 PCS
1/4" 6.3 mm
HSS 4241



YATO
YT-06035

Ø [mm]

0-6, 1-8, 2-10, 3-12, 4-14

40

EN Universal extractor set
PL Uniwersalny zestaw do wykręcania
DE Gewindeausdreh-Satz
RU Набор экстракторов для болтов и гаек
CZ Nástrojová sada pro poškozené šrouby a matice
HU Szerszámkészlet sérült csavarokhoz és anyákhoz
RO Set universal de extras suruburi
FR Extracteurs universels de vis et d'écrous
IT Set universale di cacciaviti
ES Juego de extractores tornillos rotos
CN 螺丝螺母取出器

26 PCS
3/8" 9.5 mm
CrMo 35
CrMo 42
HSS 4341
HRC 47-50



1/4", 8 mm, 3/8", 10 mm, 11 mm, 12 mm, 1/2", 13 mm, 14 mm, 16 mm, 17 mm, 11/16", 19 mm; CrMo 42;
M3-M6, M6-M8, M8-M11, M11-M14, M14-M18, M18-M24; CrMo 35;
2.4, 3.2, 4.0, 6.4, 7.2, 9.5 mm; HSS 4341;
1/4" (6.3 mm) x 3/8" (9.5 mm)

YATO
YT-05893

10

EN Universal extractor set
PL Uniwersalny zestaw do wykręcania
DE Gewindeausdreh-Satz
RU Набор инструментов для поврежденных болтов и гаек
CZ Nástrojová sada pro poškozené šrouby a matice
HU Szerszámkészlet sérült csavarokhoz és anyákhoz
RO Set extractoare suruburi si piulite
FR Etablir extractoare suruburi si piulite
IT Set universale di cacciaviti
ES Extractores establecer vis et écrous
CN 破损螺母取出器

26 PCS
3/8" 9.5 mm
HSS
CrMo 42

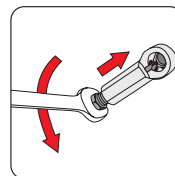

6, 8, 9, 10, 11, 12, 13, 14, 15, 16, 17, 18, 19 mm; CrMo 42;
10-19 mm, 15-29 mm; CrMo 42;
M3-M5, M4-M6, M5-M8, M6-M10, M8-M14; CrMo 42;
2.5, 3.2, 4, 6.4, 7.2 mm; HSS;
1/4" (6.3 mm), 3/8" (9.5 mm)

YATO
YT-06037

10

EN Twist socket set
PL Zestaw wykrętek do śrub
DE Schraubendrehersatz
RU Набор для извлечения обломанных болтов
CZ Sada vyťahováku stržených šroubů
HU Törtcsavar kiszedő készlet
RO Set de chei pt. șuruburi
FR Set d'extracteurs aux vis
IT Set estrattori per dadi
ES Juego de destornilladores
CN 螺栓取出器组套

5 PCS
3/8" 9.5 mm
CrMo



3/8" (9.5 mm): 10, 11, 13, 14, 16 mm

YATO
YT-06038

10/20

EN Screw extractor set
 PL Wykrętki do zerwanych śrub
 DE Schraubenausdrehsatz
 RU Набор для извлечения обломанных болтов
 CZ Vrtáky do přetržených šroubu
 HU Törtcsavar kiszedő készlet
 RO Capete pt. desurubată şuruburi rupte
 FR Set d'extracteurs aux vis
 IT Estrattori di viti
 ES Destornillador para tornillos arrancados
 CN 断丝取出器组套



6
PCS

No.	Ø [mm]	L [mm]
#1	3-6	52
#2	6-8	58
#3	8-11	66
#4	11-14	75
#5	14-18	80
#6	18-25	88

EN Tap socket set
 PL Zestaw adapterów do gwintowników
 DE Adaptersatz für Gewindebohrer
 RU Набор адаптеров для метчиков
 CZ Sada hlavic na závítníky
 HU Menetfűrő dugókulcs adapter készlet
 RO Set tubulare pt. tarazi
 FR Jeu d'adapteurs pour tarauds
 IT Set di adattatori per madreviti
 ES Juego de adaptadores para machos de roscar
 CN 丝锥套筒组套

10
PCS

1/4" 6.3mm 3/8" 9.5mm

CrV



1/4" (6.3 mm): #1, #2, #3, #3.5, #4, #4.5; 3/8" (9.5 mm): #5, #6, #7, #8

YATO
YT-0590 12/48

YATO
YT-29280 1/4" (6.3 mm), 3/8" (9.5 mm) 10/40

EN Bolt extractor set
 PL Zestaw wykrętek do szpilek
 DE Satz von Ausziehvorrichtungen für Stifte
 RU Набор экстракторов для шпилек
 CZ Souprava na demontáž závrtných šroubů
 HU Csavarkihajító készlet
 RO Set de şurubelnițe pt. tije
 FR Set d'extracteurs aux épingles

EN Set bussola estrattore per brugola
 ES Juego de extractores de alfileres
 CN 断丝取出器组套

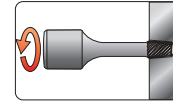

HRC 49-52

8660
HIGH-CARBON STEEL
ENJINERUNGSGEHT



6
PCS

3/8" 9.5mm

YATO
YT-0623 2, 3, 4, 6, 8, 10 50



5
PCS

1/2" 12.7mm

YATO
YT-0624 8, 10, 12, 14, 16 20

EN Bolt extractor set
 PL Zestaw wykrętek do szpilek
 DE Satz von Ausziehvorrichtungen für Stifte
 RU Набор бит экстракторов для шпилек
 CZ Souprava na demontáž závrtných šroubů
 HU Csavarkihajító készlet

RO Set de şurubelnițe pt. tije
 FR Set d'extracteurs aux épingles
 IT Set bussola estrattore per brugola
 ES Juego de extractores de alfileres
 CN 断丝取出器

10
PCS

CrMo 42

HRC 50-53

EN Bolt extractor set
 PL Zestaw wykrętek do szpilek
 DE Satz von Ausziehvorrichtungen für Stifte
 RU Набор экстракторов для шпилек
 CZ Souprava na demontáž závrtných šroubů
 HU Csavarkihajító készlet

RO Set de şurubelnițe pt. tije
 FR Set d'extracteurs aux épingles
 IT Set bussola estrattore per brugola
 ES Juego de extractores de alfileres
 CN 断丝取出器组套

25
PCS

3-23 mm

CrV 50 HRC 50-53



3, 4, 5, 5.5, 6, 7, 8, 9, 10, 11 mm; 1/8", 5/32", 3/16", 7/32", 1/4", 9/32", 5/16", 11/32", 3/8", 13/32"

YATO
YT-05890 20



3, 4, 5, 5.5, 6, 7, 8, 9, 10, 11, 12, 13, 13.5, 14, 15, 16, 17, 17.5, 18, 19, 20, 21, 21.5, 22, 23 mm

YATO
YT-06034 10

EN Damaged bolt removal set
 PL Zestaw bitów do obrobionych śrub
 DE Schraubenausdreher-Bitsatz für beschädigte Schrauben
 RU Набор бит экстракторов для выкручивания винтов
 CZ Sada bitů pro obráběné šrouby
 HU Megmunkált csavar eltávolító készlet
 RO Set extractoare şuruburi deteriorate
 FR Jeu de extracteurs de vis
 IT Kit estrattori per viti bulloni danneggiati
 ES Conjunto de puntas para tornillos desgastados
 CN 紧固件拆卸特殊六角套筒旋头组套

8
PCS

1/4" 6.3mm 3/8" 9.5mm

AISI S2 CrV



1/4" (6.3 mm): L=38 mm; H3, H4, H5, H6; 3/8" (9.5 mm): L=50 mm; H7, H8, H9, H10

YATO
YT-04580 10/40

EN Damaged bolt removal set
 PL Zestaw bitów do obrobionych śrub
 DE Schraubenausdreher-Bitsatz für beschädigte Schrauben
 RU Набор бит экстракторов для выкручивания винтов
 CZ Sada bitů pro obráběné šrouby
 HU Megmunkált csavar eltávolító készlet
 RO Set extractoare şuruburi deteriorate
 FR Jeu de extracteurs de vis
 IT Kit estrattori per viti bulloni danneggiati
 ES Conjunto de puntas para tornillos desgastados
 CN 紧固件拆卸特殊星型套筒旋头组套

7
PCS

1/4" 6.3mm

AISI S2 CrV



1/4" (6.3 mm): L=38 mm; TE10, TE15, TE20, TE25, TE27, TE30, TE40

YATO
YT-04581 15/60

EN Heavy duty nut splitter
PL Zestaw przecinaków do nakrętek
DE Meißelsatz für Schraubenmuttern
RU Набор зубил для гаек
CZ Souprava sekáčů na matice
HU Csavaranya-vágó

RO Set retezatoare capace
FR Set de burins
IT Set estrattore dado
ES Juego de tajaderas para tuercas
CN 螺母破拆组套

4 PCS
HRC 40-45
CrV

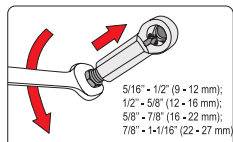

5/16" - 1/2" (9 - 12 mm);
1/2" - 5/8" (12 - 16 mm);
5/8" - 7/8" (16 - 22 mm);
7/8" - 1-1/16" (22 - 27 mm)

YATO
YT-0585

10

EN Roller stud extractor set
PL Zestaw wykrętków do szpilek
DE Stehbolzen-Ausdreher Satz
RU Набор ключей для снятия штифтов
CZ Vytahováky závitových šteftů
HU Komplet tükkihúzó készlet
RO Set de dispozitive

No.	● [mm]	D [mm]	L [mm]	A [mm]
#1	6	24	60	21
#2	8			
#3	10	28	70	
#4	12			

4 PCS
CrV
50BV30

pt. demontat suruburi rupte
FR Extracteurs de goujons à rouleaux
IT Estrattori a rulli per viti prigioniere
ES Juego de extractores de espárragos
CN 螺杆取出器

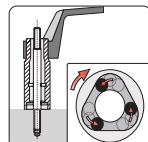
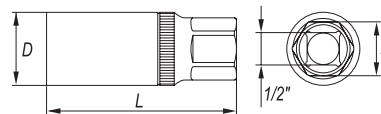

YATO
YT-0620

6/24

EN Stud extractor
PL Wykrętko do śrub szpilek i nakrętek
DE Stehbolzenausdreher
RU Шпильковерт универсальный
CZ Klíč na povolení závrtných šroubů
HU Sérültefejtű csavar kiszedő
RO Extractor pt. suruburi
FR Extracteur de goujon, écrou ou boulon arrondis
IT Stud estratore
ES Extractor de espárragos
CN 断头螺丝取出器

1/2"
12.7mm
8.5-19 mm



YATO
YT-06251

10/30

EN Stud extractor
PL Wykrętko do śrub szpilek i nakrętek
DE Stehbolzenausdreher
RU Шпильковерт универсальный
CZ Klíč na povolení závrtných šroubů
HU Sérültefejtű csavar kiszedő
RO Extractor pt. suruburi
FR Extracteur de goujon, écrou ou boulon arrondis
IT Stud estratore
ES Extractor de espárragos
CN 断头螺丝取出器

FOR IMPACT TOOLS DO WARSZTAZU UDAROWYCH
6-11 mm
24 mm
3/8" 9.5 mm
HRC 40-45
CrMo



YATO
YT-06255

6/36

EN Stud extractor
PL Wykrętko do śrub, szpilek i nakrętek
DE Stehbolzenausdreher
RU Шпильковерт универсальный
CZ Klíč na povolení závrtných šroubů
HU Sérültefejtű csavar kiszedő
RO Extractor pt. suruburi
FR Extracteur de goujon, écrou ou boulon arrondis
IT Stud estratore
ES Extractor de espárragos
CN 断头螺丝取出器

FOR IMPACT TOOLS DO WARSZTAZU UDAROWYCH
6-11 mm
24 mm
1/2" 12.7 mm
HRC 40-45
CrMo



YATO
YT-06256

6/36

EN Tie rod end lifter
PL Ściągacz do sworzni kulistych
DE Universal-Kugelgelenk-Abzieher
RU Съёмник шаровых опор
CZ Stahovák kulových čepů řízení
HU Gömbfej kinyomó
RO Extractor pt. articulatii sferice
FR Extracteur de rotue
IT Estrattore per snodi sferici
ES Extractor de pernos esféricos
CN 球头拉拔器

19 mm
100 mm
20-60 mm
20 mm
40Cr



YATO

[mm] L [mm] Ø [mm]

YT-06122

19 100 20 20

EN Tie rod end lifter
PL Ściągacz do sworzni kulistych
DE Universal-Kugelgelenk-Abzieher
RU Съёмник шаровых опор
CZ Stahovák kulových čepů řízení
HU Gömbfej kinyomó
RO Extractor pt. articulatii sferice
FR Extracteur de rotue
IT Estrattore per snodi sferici
ES Extractor de pernos esféricos
CN 球头拉拔器

19 mm
135 mm
15-50 mm
17.5 mm



YATO

[mm] L [mm] Ø [mm]

YT-0612

19 135 17.5 9/18

EN Tie rod end lifter
PL Ściągacz do sworzni kulistych
DE Universal-Kugelgelenk-Abzieher
RU Струцидна для шаровых опор
CZ Stahovák kulových čepů řízení
HU Gömbfej kinyomó
RO Extractor pt. articulatii sferice
FR Extracteur de rotue
IT Estrattore per snodi sferici
ES Extractor de pernos esféricos
CN 球头取出器

19 mm
160 mm
35-80 mm
30 mm



YATO

[mm] L [mm] Ø [mm]

YT-06123

19 160 30 10

EN Tie rod end lifter
PL Ściągacz do sworzni kulistych
DE Universal-Kugelgelenk-Abzieher
RU Съёмник шаровых опор
CZ Stahovák kulových čepů řízení
HU Gömbfej kinyomó
RO Extractor pt. articulatii sferice
FR Extracteur de rotue
IT Estrattore per snodi sferici
ES Extractor de pernos esféricos
CN 球头拉拔器

16 mm
265 mm
275 mm



YATO

[mm] L [mm] Ø [mm]

YT-0613

16 265 17 20

YT-0614

16 275 20 20

EN Inner tie rod tool
 PL Klucz do drążków kierowniczych
 DE Spurstangengelenk Lösewerkzeug
 RU Ключ для шарнира рулевой рейки
 CZ Přípravek na axiální táhla
 HU Csukló szerelő

RO Cheia de la tija de cravată
 FR Clé pour pour rotules de direction
 IT Chiave per il tirante
 ES Extractor mecanismo de dirección
 CN 拉拔器

200
mm

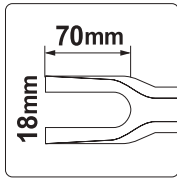

YATO	L [mm]	
YT-0615	200	18/36

EN Inner tie rod tool
 PL Klucz do drążków kierowniczych
 DE Spurstangen-Schlüssel
 RU Ключ для шарнира рулевой рейки
 CZ Přípravek na axiální táhla
 HU Axiál csukló szerelő
 RO Cheie bielete directie
 FR Clé de biellette de direction
 IT Chiave per il tirante
 ES Extractor rótulas axiales
 CN 大机舵扳手

1/2"
12.7mm **35-42**
mm



YATO	
YT-06160	25

EN Inner tie rod tool
 PL Klucz do drążków kierowniczych
 DE Spurstangen-Schlüssel
 RU Ключ для шарнира рулевой рейки
 CZ Přípravek na axiální táhla
 HU Axiál csukló szerelő
 RO Cheie bielete directie
 FR Clé de biellette de direction
 IT Chiave per il tirante
 ES Extractor rótulas axiales
 CN 方向机舵扳手



1/2"
12.7mm **40-47**
mm
CrMo

YATO	
YT-06160Z	30

EN Inner tie rod tool
 PL Klucz do drążków kierowniczych
 DE Spurstangen-Schlüssel
 RU Ключ для шарнира рулевой рейки
 CZ Přípravek na axiální táhla
 HU Axiál csukló szerelő
 RO Cheie bielete directie
 FR Clé de biellette de direction
 IT Chiave per il tirante
 ES Extractor rótulas axiales
 CN 四方滤清扳手



1/2"
12.7mm **27-42**
mm
CrMo

YATO	
YT-06162	10/20

EN Inner tie rod tool
 PL Klucz do drążków kierowniczych
 DE Spurstangen-Schlüssel
 RU Ключ для шарнира рулевой рейки
 CZ Přípravek na axiální táhla
 HU Axiál csukló szerelő
 RO Cheie bielete directie
 FR Clé de biellette de direction
 IT Chiave per il tirante
 ES Extractor rótulas axiales
 CN 大机舵扳手



1/2"
12.7mm **30-42**
mm
CrMo

YATO	
YT-06163	40

EN Track rod end remover & installer set
 PL Zestaw kluczy do drążków kierowniczych
 DE Schlüsselsatz für Zahnstangenlenkung
 RU Набор ключей для рулевых тяг
 CZ Sada klíčů pro řhben řízení
 HU Kormányrúd telepítő készlet-eltávolító
 RO Set montare-demontare bieleta
 FR Clé pour rotules de direction
 IT Set di chiavi suggerimenti smontaggio tiranti sterzo
 ES Herramienta de llaves para barras de dirección
 CN 轴接头工具组套



4
PCS
 30-45
mm



Ø 30-35mm, 35-40mm, 40-45mm

YATO	
YT-06155	4

EN Tie rod / ball joint tool kit
 PL Ściągacze do drążków
 DE Werkzeugsatz für Bremssattel
 RU Съемник штанг
 CZ Stahováký táhel řízení
 HU Rúdlehúzó
 RO Ancore pt. tije
 FR Set d'extracteurs pour rotules de direction
 IT Set tiranti per estrattore
 ES Tensores para palancas
 CN 汽修工具

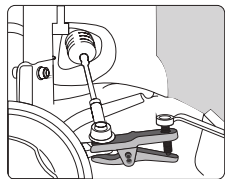

6
PCS



YATO	
YT-06157	5

EN Tie rod / ball joint tool kit
 PL Ściągacze do drążków
 DE Werkzeugsatz für Bremssattel
 RU Съемник штанг
 CZ Stahováký táhel řízení
 HU Rúdlehúzó
 RO Ancore pt. tije
 FR Set d'extracteurs pour rotules de direction
 IT Set tiranti per estrattore
 ES Tensores para palancas
 CN 球头拉拔器组套

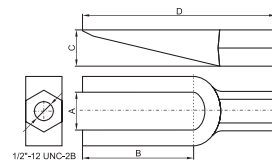

5
PCS

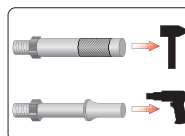

YATO	
YT-0616	10

EN Seal puller
PL Ściągacz do uszczeltek
DE Dichtungs-Abziehwerkzeug
RU Съемник прокладок
CZ Škrabka na těsnění
HU Tömítéshúzó

RO Ancoră pt. garnituri
FR Outil pour extraire les joints
IT Estrattore per guarnizioni
ES Tensor para juntas
CN 密封圈拉拔器

max Ø
85 mm

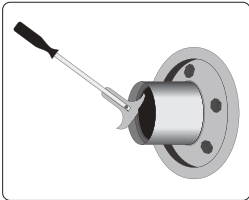

YATO 

YT-0642

L [mm]

200



12/48

EN Universal hook and pick set
PL Zestaw haków i skrobaków z rękojeścią
DE Haken- und Schabersatz mit Griff
RU Набор крючков и скребков с рукожкой
CZ Sada háků a škrabek s rukojetí
HU Fogantyús kampó- és kaparókészlet
RO Set universal carlige extras garnituri
FR Kit de crochets et de grattoirs avec poignée
IT Set di ganci e raschetti con impugnatura
ES Juego de ganchos y raspadores con mango
CN 发动机清理工具

5 PCS

200 mm

225 mm

23x220 mm

23x245 mm

40Cr



YATO 

YT-08422



6/24

EN Universal hook set
PL Zestaw haczyków z rękojeścią
DE Hakenset mit Handgriff
RU Набор крючков с рукожкой
HU Fogantyús kampó készlet

RO Set universal extractoare garnituri
FR Jeu de crochets avec manche
IT Set di ganci con maniglia
ES Set de ganchos para extracción con mango
CN 油封起子

7 PCS

162 mm

205 mm

40Cr



YATO 

YT-08425



6/24

EN Universal hook set
PL Zestaw haczyków z rękojeścią
DE Hakenset mit Handgriff
RU Набор крючков с рукожкой
HU Fogantyús kampó készlet

RO Set universal extractoare garnituri
FR Jeu de crochets avec manche
IT Set di ganci con maniglia
ES Set de ganchos para extracción con mango
CN 油封起子

9 PCS

162 mm

240 mm

40Cr



YATO 

YT-08426



6/12

EN Long reach hook and pick tool set
PL Zestaw haków długich z rękojeścią
DE Langhakensatz mit Griff
RU Набор длинных крючков с рукожкой
CZ Sada dlouhých háků s rukojetí
HU Fogantyús hosszú kampókészlet

RO Set lung pt. extras garnituri
FR Kit de longs crochets avec poignée
IT Set di ganci lunghi con impugnatura
ES Juego de ganchos largos con mango
CN 油封起子

4 PCS

240 mm

40Cr



YATO 

YT-08429



6/72

EN Long reach hook and pick tool set
PL Zestaw haków długich z rękojeścią
DE Langhakensatz mit Griff
RU Набор длинных крючков с рукожкой
CZ Sada dlouhých háků s rukojetí
HU Fogantyús hosszú kampókészlet

RO Set lung pt. extras garnituri
FR Kit de longs crochets avec poignée
IT Set di ganci lunghi con impugnatura
ES Juego de ganchos largos con mango
CN 油封起子

6 PCS

240 mm

40Cr



YATO 

YT-08428



6/48

- EN Seal remover and hose pick set
 PL Zestaw do demontażu uszczelnień i oringów
 DE Demontageset für Dichtungen und O-Ringe
 RU Набор для снятия уплотнений и уплотнительных колец
 CZ Sada pro demontáž těsnění a těsnících kroužků
 HU O-ring és tömítésleszedő készlet

- RO Dispozitiv indepartat sigilii si set carlige
 FR Kit crochet pour joint torique
 IT Kit di strumenti per rimozione di guarnizioni e O-ring
 ES Juego de remoción de sellado y juntas tóricas
 CN 油封钩

6 PCS 120 mm
 150 mm 160 mm
 200 mm 210 mm
 290 mm
 SPECIAL SHAPE SPECJALNY KSZTAŁT



- EN Hook set for o-ring
 PL Zestaw haczyków do uszczelniaaczy
 DE Dichtungs-Haken-Satz
 RU Комплект крючков для герметиков
 CZ Sada háčků pro těsnící prstény
 HU Kampókészlet tömítésekhez

- RO Set carlige pt. o-ring
 FR Ensemble de crochet à joint d'étanchéité
 IT Set di ganci per sigillanti
 ES Set de ganchos para selladores
 CN 密封拉拔器

8 PCS
 165 mm
 225 mm
 SPECIAL SHAPE SPECJALNY KSZTAŁT



YATO YT-08432 5

YATO YT-08431 48

- EN Bearing and bush driver set
 PL Zestaw do osadzania łożysk i uszczelniaaczy
 DE Lager- und Buchsentreiber-Satz
 RU Набор для установки подшипников и сальников
 CZ Sada pro montáž gufer a ložisek
 HU Csapagy és szimering beütő készlet
 RO Set pt. inlocuit rulment, simering
 FR Outils pour montage des roulements et joint
 IT Set di tamponi per cuscinetti e guarnizioni
 ES Juego de conductores del anillo y del sello de rodadura
 CN 斜型培令套安装器

10 PCS AI

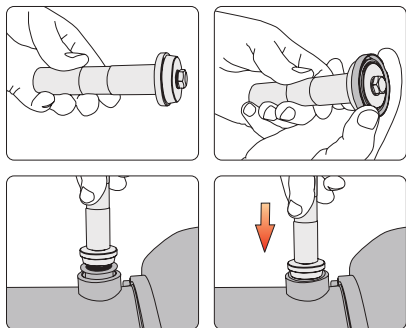

No.	Ø (mm)
01	40
02	44
03	50
04	59
05	63
06	65
07	72
08	76
09	81

YATO YT-0638 5/10

- EN Bearing and bush driver set
 PL Zestaw do osadzania łożysk i uszczelniaaczy
 DE Lager- und Buchsentreiber-Satz
 RU Набор для установки подшипников и сальников
 CZ Sada pro montáž gufer a ložisek
 HU Csapagy és szimering beütő készlet
 RO Set pt. inlocuit rulment, simering
 FR Outils pour montage des roulements et joint
 IT Set di tamponi per cuscinetti e guarnizioni
 ES Juego de conductores del anillo y del sello de rodadura
 CN 斜型培令套安装器

17 PCS AI



No.	Ø (mm)	No.	Ø (mm)	No.	Ø (mm)
01	10x12	06	18x20	11	30x34
02	12x14	07	20x22	12	32x36
03	14x16	08	22x24	13	35x40
04	15x17	09	25x27	14	38x42
05	16x18	10	28x30		

YATO YT-25415 10

EN Car radio removal tool set
PL Zestaw do demontażu radioodbiorników samochodowych
DE Autoradio Demontage Werkzeugsatz
RU Набор для разборки авто-ресиверов

CZ Sada k demontáži autorádií
HU Autorádió kiszereelő készlet
RO Trusa de scule pt. indepartat radio
FR Set d'outils pour dépose autoradio

IT Set estrattori per autoradio
ES Juego para el desmontaje de autorradio
CN 收音机拆卸组套

52
PCS

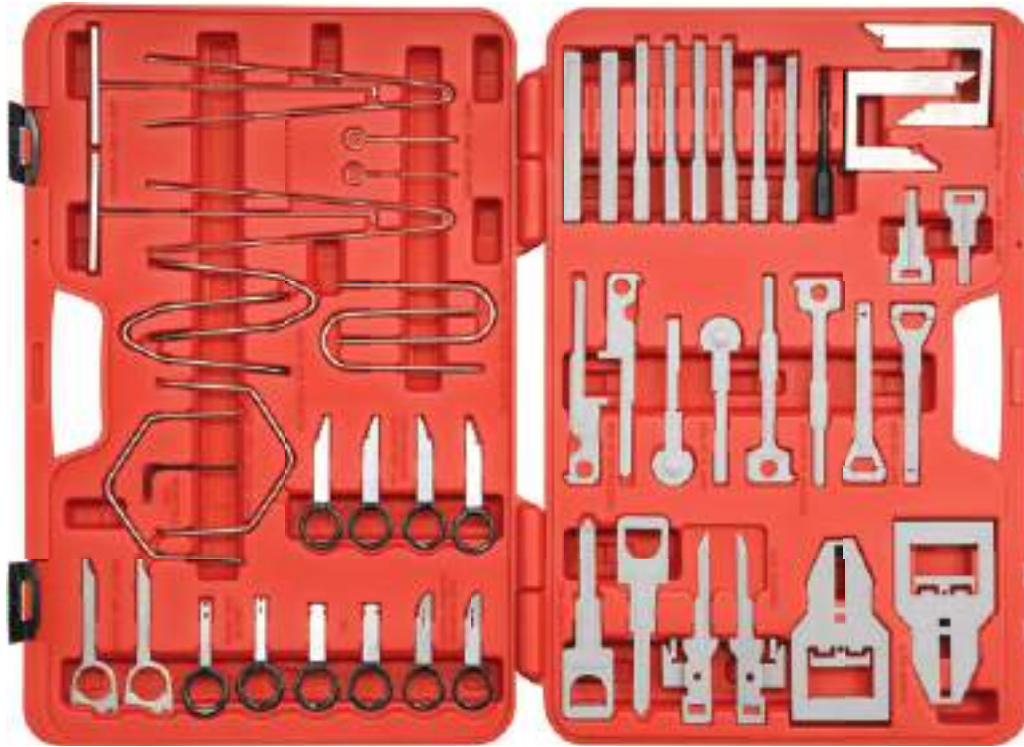

Included: radio removal keys: VW, Audi, Becker, Mercedes (4 PCS); Mercedes, Porsche, Becker (2 PCS); VW (2 PCS); new Becker (2 PCS); new Skoda (2 PCS); Fiat Brava (2 PCS); Mercedes-Benz, BMW (6 PCS); Kenwood II 1998-2001 (2 PCS); Sony II since 2002 (2 PCS); Kenwood III since 2002 (2 PCS); Pioneer, JVC (2 PCS); Sony I until 2001 (2 PCS); Panasonic (2 PCS); Kenwood I until 1998 (2 PCS); Kenwood Mask (2 PCS); new Clarion (2 PCS); old Clarion (2 PCS); Panasonic 2006 (2 PCS); Sony IDIC 2005 (2 PCS); radio removal U-hooks: Ford, VW, Audi, Grundig, Blaupunkt (2 PCS); new Blaupunkt (2 PCS); Opel (2 PCS); special pentagon wrench (BMW); allen hex wrench (BMW, Opel)

W zestawie: klucze do demontażu radia: VW, Audi, Becker, Mercedes (4 szt.); Mercedes, Porsche, Becker (2 szt.); VW (2 szt.); nowy Becker (2 szt.); nowa Skoda (2 szt.); Fiat Brava (2 szt.); Mercedes-Benz, BMW (6 szt.); Kenwood II 1998-2001 (2 szt.); Sony II od 2002 (2 szt.); Kenwood III od 2002 (2 szt.); Pioneer, JVC (2 szt.); Sony I do 2001 (2 szt.); Panasonic (2 szt.); Kenwood I do 1998 (2 szt.); Kenwood Mask (2 szt.); nowy Clarion (2 szt.); stary Clarion (2 szt.); Panasonic 2006 (2 szt.); Sony IDIC 2005 (2 szt.); haki do demontażu radia: Ford, VW, Audi, Grundig, Blaupunkt (2 szt.); nowy Blaupunkt; (2 szt.); Opel (2 szt.); specjalny klucz pięciokątny (BMW); klucz imbusowy (BMW, Opel)

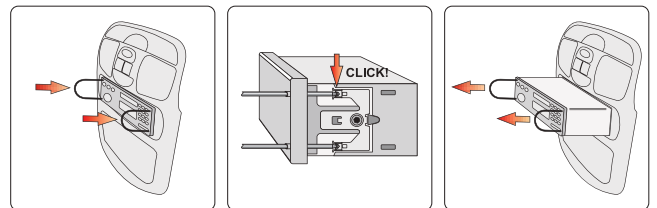

YATO
YT-0838

10

EN Door upholstery remover
PL Ściągacz do spinek tapicerki
DE Abziehvorrichtung für Polstererklammern
RU Съемник крепежа обивки

CZ Uvolňovač čalounění dveří
HU Kárpítkiszedő
RO Dispozitiv de scos agrafe de tapiterie
FR Arrache agrafes

IT Estrattore per la rimozione di graffette tappezzeria
ES Extractor de grapas de vestidura
CN 胶扣起子

SVC



YATO	Internal width / Szerokość wewnętrzna [mm]	L [mm]	
YT-1370	6	100	12/120



YATO	Internal width / Szerokość wewnętrzna [mm]	L [mm]	
YT-1371	6.2	115	12/120



YATO	Internal width / Szerokość wewnętrzna [mm]	L [mm]	
YT-1372	10	115	12/120



YATO	Internal width / Szerokość wewnętrzna [mm]	L [mm]	
YT-1373	9.5	134	6/96

EN Scratch awl
PL Szpikulec prosty
DE Einfache Spicknadel
RU Прямое шило
CZ Šídlo rovné
HU Spékelőtű, egyenes

RO Dorn perforare drept
FR Brochette droite
IT Punteruolo piatto
ES Punzón recto
CN 锥子



SVC



90°

SVC



YATO	L [mm]	
YT-1374	120	12/120

EN Hook bodkin
PL Szpikulec hakowy
DE Hakenspicknadel
RU Изогнутое шило
CZ Šídlo háčkové
HU Spékelőtű, horgos

RO Dorn perforare înoîdit
FR Brochette coudée
IT Gancio punteruolo
ES Punzón encorvado
CN 油封拉拔器





YATO	L [mm]	
YT-1375	125	12/120

EN Battery cap tool
 PL Ściągacz do клем akumulatora
 DE Abziehvorrichtung für Akkuklemmen
 RU Стяжка для клемм аккумулятора
 CZ Stahovák svorek akumulátoru
 HU Akkumulátor saru lehvűzű

RO Extractor pt. clem accumulator
 FR Tournevis plat pour bouchons de batterie
 IT Batteria clem estrattore
 ES Extractor para los bornes de la batería
 CN 扁铲





YATO 	Working width / Szerokość robocza [mm]	L [mm]	
YT-1378	18.5	100	12/120

EN Glass scraper
 PL Skrobak do szyby
 DE Scheibenkratzer
 RU Шабер для стекла

CZ Škrabka na okna
 HU Jégkaparó
 RO Răzuitor geamuri
 FR Gratteur pour vitres

IT Raschietto per vetro
 ES Rascador para os vidrios
 CN 刮刀





YATO 	Working width / Szerokość robocza [mm]	L [mm]	
YT-1379	39	200	6/72

EN Spare blades for glass scraper
 PL Ostrze do skrobaka do szyby
 DE Abbrechklingen
 RU Лезвия для универсальных ножей
 CZ Lomené ostří náhradní
 HU Törhető tartalékpenge

RO Lame de rezervă rupte
 FR Lames pour gratteur pour vitres
 IT Lame per raschietto
 ES Filo partido de recambio
 CN 刮刀片配件



For YT-1379
 Dia YT-1379

YATO 	Blade size / Rozmiar ostrza [mm]	
YT-13790	19x39	50

EN Flexible spinner handle
 PL Pokrętko elastyczne
 DE Elastischer Dreher

RU Эластичный вороток
 CZ Šroubovák ohebný
 HU Hajlékony csavarhűzű

RO Măner flexibil
 FR Barre élastique
 IT Chiave flessibile

ES Llave flexible
 CN 套筒螺丝批



YATO 		L [mm]	
YT-1381	1/4" (6.3 mm)	150	6/96

EN Flexible magnetic bit driver
 PL Pokrętko elastyczne do bitów
 DE Elastischer Dreher für Bits

RU Эластичный вороток для разряда битов
 CZ Šroubovák ohebný na bity
 HU Hajlékony csavarhűzű, hosszú

RO Măner flexibil pt. vârf șurubelnită
 FR Barre élastique
 IT Chiave flessibile

ES Mango flexible para desarmadores
 CN 批头螺丝批



YATO 		L [mm]	
YT-1382	1/4" (6.3 mm)	380	6/72

EN Flexible magnetic pick up tool
 PL Elastyczny uchwyt magnetyczny
 DE Elastische Magnethalterung
 RU Эластичный магнитный держатель

CZ Ohebný magnetický držák
 HU Hajlékony csavarhűzű, hosszú, mágneses
 RO Măner magnetic flexibil
 FR Capteur magnétique

IT Mango flexible para desarmadores
 ES Mango magnético flexible
 CN 拾拾器



YATO 	L [mm]	
YT-1385	400	6/72

EN Door upholstery remover
 PL Ściągacz do spinek tapicerkí
 DE Abziehvorrichtung für Polstererklammern
 RU Съёмник крепежа обивки



CZ Uvolňovač čalounění dveří
 HU Kárpitkiszedő
 RO Dispozitiv de scos agrafe de tapijerie
 FR Spatule d'extraction de clips

IT Estrattore per la rimozione di graffette tappezzeria
 ES Extractor de grapas de vestidura
 CN 胶扣起子



YATO 	L [mm]	
YT-0841	230	16/64



YATO 	L [mm]	
YT-0842	230	25/100

EN Panel removal set
PL Ściągacze do tapicerki
DE Abziehvorrichtung für Polsterung
RU Съемник обивки
CZ Sada k demontáži čalounění
HU Kárpitlehúzó

RO Ancore pt. tapijerie
FR Set d'extracteurs à la tapisserie
IT Leve in plastica per la tappezzeria
ES Tensores para las vestiduras
CN 面板拆卸组套



YATO
YT-0836

6/24

EN Panel removal set
PL Ściągacze do tapicerki
DE Abziehvorrichtung für Polsterung
RU Съемник обивки
CZ Sada k demontáži čalounění
HU Kárpitlehúzó

RO Ancore pt. tapijerie
FR Set d'extracteurs à la tapisserie
IT Leve in plastica per la tappezzeria
ES Tensores para las vestiduras
CN 面板拆卸组套

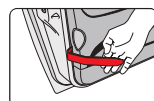

YATO
YT-0837

6/24

EN Panel removal set
PL Ściągacze do tapicerki
DE Abziehvorrichtung für Polsterung
RU Съемник обивки
CZ Sada k demontáži čalounění
HU Kárpitlehúzó

RO Ancore pt. tapijerie
FR Set d'extracteurs à la tapisserie
IT Leve in plastica per la tappezzeria
ES Tensores para las vestiduras
CN 面板拆卸组套

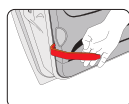

YATO
YT-0844

5/10

EN Panel removal tool kit
PL Zestaw do obsługi tapicerki
DE Servicesatz für Polsterung
RU Набор для обработки обивки
CZ Sada pro práci s čalouněním
HU Kárpiteszedő készlet

RO Kit indepartare panouri
FR Kit d'outils pour démontage de garniture de voiture
IT Kit di strumenti per tappezzeria interni
ES Juego de manipulación de tapicería
CN 汽车面板拆卸工具组套

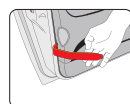

YATO
YT-08442

12

EN Panel removal set
PL Ściągacze do tapicerki
DE Abziehvorrichtung für Polsterung
RU Съемник обивки
CZ Sada k demontáži čalounění
HU Kárpitlehúzó

RO Ancore pt. tapijerie
FR Set d'extracteurs à la tapisserie
IT Leve in plastica per la tappezzeria
ES Tensores para las vestiduras
CN 撬棍

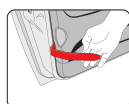

YATO
YT-08443

10

EN Scraper set
PL Zestaw skrobaków do uszczelce
DE Dichtungsschaber-Satz
RU Набор скребков для прокладок
CZ Sada dítek do těsnění
HU Tömítés kaparó készlet

RO Set raziuitoare
FR Jeu de racloirs pour joints d'étanchéité
IT Set di raschietti per la rimozione di guarnizioni
ES Juego de rascadores para juntas
CN 铲刀

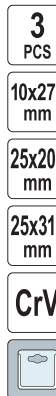

YATO
YT-08474

5/20

EN Plastic scraper set
PL Zestaw skrobaków plastikowych
DE Satz von Kunst-Stoffschabern
RU Набор пластмассовых шаберов
CZ Souprava plastových škrabek
HU Műanyag vakaró készlet
RO Set de răzuitoare din plastic
FR Kit de grattoirs en plastique
IT Set di raschietto
ES Juego de rascadores de plástico
CN 塑料刮刀



3/4" (19 mm); 7/8" (22 mm); 1" (25 mm); 1 1/2" (37.5 mm)

YATO
YT-0847

L [mm]
265

6/36

EN Plastic chisel set
PL Przecinaki z tworzywa
DE Kunststoff-Meißel-Satz
RU Съемники пластиковые панелей облицовки
CZ Plastový klin pro autoklempře
HU Műanyag véső készlet
RO Set dalti din plastic
FR Outils pour le rembourrage de voiture
IT Scalpelli in plastica
ES Cinceles plásticos para molduras
CN 撬棍



YATO
YT-08477

10/60

EN Lockout wedge set
 PL Kliny montażowe
 DE Zierleistenkeil mit Loch
 RU Клин удаления монтировки
 CZ Sada montážních klínů
 HU Szerelőék készlet
 RO Set pene de montaj
 FR Cales de montage
 IT Cunei di fissaggio
 ES Cuiñas plásticas
 CN 塑料刹车块

4 PCS \varnothing 25 mm 100x50 x25 mm



YATO
 YT-67370

12/48

EN Lockout wedge set
 PL Kliny montażowe
 DE Zierleistenkeil mit Loch
 RU Клин удаления монтировки
 CZ Sada montážních klínů
 HU Szerelőék készlet
 RO Set pene de montaj
 FR Cales de montage
 IT Cunei di fissaggio
 ES Cuiñas plásticas
 CN 撬棍

5 PCS NYLON

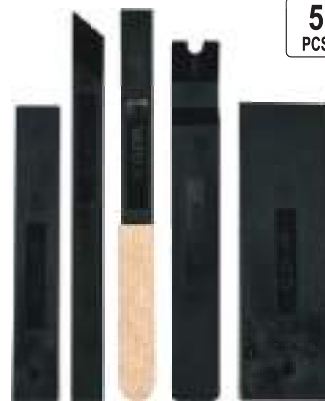

YATO
 YT-67371

6/24

EN Quick release cut out tool
 PL Nóż do wycinania szyb
 DE Schneidmesser für Scheiben
 RU Нож для вырезания стекол
 CZ Nůž na vyřezávání skel
 HU Szélvédőkivágó kés
 RO Cuițit tăietor de geam
 FR Kit de découpe pare-brise
 IT Tagliolo per il vetro
 ES Cuchilla para cortar cristales
 CN 玻璃橡胶刮除器

X3 BLADES OSTRZA QUICK RELEASE SZYBKO-ZŁĄCZE
 AI K5



YATO
 YT-0659

20/40

EN Spare blades for cut out tool
 PL Ostrza zapasowe do noża do wycinania szyb
 DE Abbrechklängenn
 RU Лезвия для ножей
 CZ Ostří náhradní
 HU Törhető tartalékpenge
 RO Rezerve cutter
 FR Lames
 IT Lame di ricambio per coltello specialistica per tagliare vetri del auto
 ES Filo partido de recambio
 CN 玻璃橡胶刮除器刀片

X3 BLADES OSTRZA K5



For YT-0659
 Dla YT-0659

3/4" (19 mm); 1" (25 mm); 1-1/2" (38 mm)

YATO
 YT-06590

10/80

EN Windshield removal set
 PL Zestaw do demontażu szyb samochodowych
 DE Demontagesatz für Autoscheiben
 RU Набор для демонтажа автостекла
 CZ Souprava na demontáž autoskel
 HU Szélvédőcserélő szett

RO Set pt. demontarea geamurilor de mașină
 FR Kit pour démontage de vitres de voiture
 IT Set di strumenti di rimozione parabrezza
 ES Juego para desmontaje de cristales de coches
 CN 风挡玻璃拆卸组套

7 PCS HRC 38-42



YATO
 YT-0845

10

EN Windscreen wiper arm removal tool
 PL Ściągacz do ramion wycieraczek
 DE Abzieher für Wischerarm und Polklemmen
 RU Съемник поводков стеклоочистителя
 CZ Stahovák na ramínka stěračů
 HU Ablaktörőkar-lehúzó
 RO Siguranță pt. brațele ștergătoarelor
 FR Bord aux bras d'essuie-glace
 IT Estrattore di parabrezza tergicristallo braccio
 ES Herramienta para desmontaje de las plumas de los limpiaparabrisas
 CN 雨刷臂拆卸工具

ADJUSTABLE NASTAWNY CrMo



YATO
 YT-0846

20/120

EN Two leg puller for widescreen wiper arms
 PL Ściągacz dwuramienny do ramion i wycieraczek
 DE Abzieher für Scheibenwischer
 RU Съемник стеклоочистителя батареи
 CZ Dvouřídň stahovač pro ramena stěračů
 HU Kétkaros húzó az ablaktörők karokhoz
 RO Extractor brat ștergator
 FR Extracteur d'essuie glaces
 IT Estrattore a due griffe per bracci tergicristalli
 ES Extractor tirador exterior para brazo del limpiaparabrisas
 CN 雨刷臂拉马

max 50 mm ADJUSTABLE NASTAWNY



YATO
 YT-08461

15/60

EN Two leg puller for battery terminals and widescreen wiper arms
 PL Ściągacz dwuramienny do klem i ramion wycieraczek
 DE Abzieher für Wischerarm und Polklemmen
 RU Съемник стеклоочистителя терминал батареи дворники
 CZ Stahovák na svorky akumulátorů a ramen stěračů
 HU Akkusaru és ablaktörőkar-lehúzó
 RO Extractor brat ștergator, cleme baterie
 FR Extracteur d'essuie glaces et cosse de batterie
 IT Estrattore a due griffe per binding post e bracci dei tergicristalli
 ES Extractor tirador exterior para brazo del limpiaparabrisas, terminal de batería
 CN 电瓶接头拉马

5-30 mm ADJUSTABLE NASTAWNY



YATO
 YT-25145

Ø [mm] 5-30

48

EN Two leg puller for battery terminals and widescreen wiper arms
PL Ściągacz dwuramienny do klem i ramion wycieraczek
DE Abzieher für Wischerarm und Polklemmen
RU Съемник стеклоочистителя терминал батареи дворники
CZ Stahovák na svorky akumulátoru a ramen stěračů
HU Akkusaru és ablaktörőkar-lehűző
RO Extractor brat stergator, cleme baterie
FR Extracteur d'essuie glaces et cosse de batterie
IT Estrattore a due griffe per binding post e bracci dei tergicristalli
ES Extractor tirador exterior para brazo del limpiaparabrisas, terminal de batería
CN 电瓶接头拉马



10-40 mm

ADJUSTABLE
NASTAWNY



YATO Ø [mm] 
YT-08462 10-40 6/36

EN Puller for ribbed drive pulley
PL Ściągacz kół pasowych wielorowkowych
DE Riemenscheiben Abzieher Werkzeug Keilriemenscheiben
RU Универсальный съемник шкива
CZ Staviteľný stahovák drážkových femenic
HU Bordás szíjtárcsa lehűző
RO Tragator de scripete reglabil
FR Universel extracteur de poulie d'entraînement cannelé
IT Estrattore puleggia motrice a coste
ES Extractor de polea acanalada
CN 皮带轮拉马

40-165 mm

3/8" 9,5 mm

17 mm

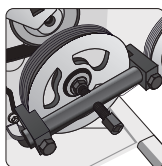

YATO 
YT-25480 10

EN Universal pulley puller
PL Ściągacz uniwersalny do kół rozrządu
DE Universal-Riemenscheiben-Abzieher
RU Съемник шкивов универсальный
CZ Univerzální stahovák ozubených kol
HU Univerzális szíjtárcsa lehűző
RO Extractor universal pt. roată distribuție
FR Extracteur de poulie universel
IT Estrattore universale per ruote di albero a camme
ES Extractor de poleas universal
CN 正时皮带轴承拉马

24 mm

60-90 mm

3 ARMS
RAMONA

8 SETTINGS
USTAWIENIA



YATO 
YT-06340 10

EN Camshaft balancer puller
PL Ściągacz wałka wyrównoważającego
DE Ausgleichwellen-Abzieher
RU Съемник балансировочного вала
CZ Stahovač hřídele vyvažovače
HU Kiegyenlítő tengely leszedő
RO Extractor arbore cu came
FR Extracteur de roue d'équilibrage
IT Estrattore per albero di bilanciamento
ES Extractor del eje de equilibrio
CN 大众平衡轴拉拔器

3 PCS

VAG

FOR CAMSHAFT
BALANCER
DO WAŁKA
WYRÓWNO-
WAŻAJĄCEGO

FOR GASOLINE
ENGINES
DO SILNIKÓW
BENZYNOWYCH



 VAG: Audi: A3 (since 2004), A4 & A5 (since 2008), TT (since 2007); Seat: Alhambra (since 2011), Altea (since 2005), Altea XL & Altea Freetrack (since 2007), Exeo (since 2009), Leon (since 2006), Toledo (since 2005); Volkswagen: Eos (since 2006), Golf (since 2004), Passat (since 2006), Passat CC (since 2009), Tiguan (since 2008)

YATO 
YT-06208 10

EN Spring clamp remover VAG
PL Ściągacz do obejm i sprężyn VAG
DE Auspuff Federklammer entferner / installer für VAG
RU Съемник пружинных, хомутов систем выпуска VAG
CZ Přípravek na montáž a demontáž svorky výfuku VAG
HU Kipufogó rugó szerelő VAG
RO Dispozitiv montaj / demontaj esapament VAG
FR Tuyau d'échappement printemps pince
outil de suppression pour VAG
IT Spring clamp rimozione VAG
ES Abrazadera de resorte herramienta de eliminación-para VAG
CN 弹簧撑



17 mm

VAG



YATO 
YT-25331 12/24

EN Ballancer puller and installer
PL Ściągacz kół pasowych z tłumikiem drgań
DE Riemenscheibenabzieher mit Schwingungsdämpfer
RU Съемник шкива виброгасителя
CZ Stahovák femenic s tlumičem vibrací
HU Ékszíjtárcsa lehűző készlet
RO Extractor și instalator de echilibrare
FR Extracteur de poulie de courroie avec amortisseur de vibrations
IT Estrattore per puleggia con smorzatore
ES Extractor de polea de la correa de transmisión con amortiguador de vibraciones
CN 正时皮带盘拆卸器

23 PCS



YATO 
YT-25483 5

EN Universal pulley puller
PL Ściągacz uniwersalny do kół rozrządu
DE Universal-Riemenscheiben-Abzieher
RU Съемник шкивов универсальный
CZ Univerzální stahovák ozubených kol
HU Univerzális szíjtárcsa lehűző
RO Extractor universal pt. roată distribuție
FR Extracteur de poulie universel
IT Estrattore universale per ruote di albero a camme
ES Extractor de poleas universal
CN 正时皮带轴承拉马

17 mm

50-80 mm

3 ARMS
RAMONA

6 SETTINGS
USTAWIENIA

ADJUSTABLE
NASTAWNY

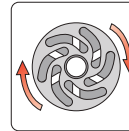

YATO 
YT-06341 10

EN Camshaft sprocket pulley puller
PL Ściągacz kół rozrządu
DE Universal-Abzieher-Satz für Nockenwellenrad
RU Набор съемников для шкива распределителя
CZ Stahovák na femenic vačkové hřídele
HU Vezérműtengely ékszíjtárcsa lehűző
RO Extractor fullii arbore cu camee
FR Extracteur de poulie d'arbres à cames
IT Estrattore per ruote di albero a camme
ES Extractor de poleas universal
CN 凸轮轴链轮拉马

5 PCS

17 mm

VAG



YATO 
YT-06342 8

- EN Fuel tank sender unit spanner
- PL Klucz pazurowy do pompy paliwa
- DE Tankgeberschlüssel
- RU Ключ для крышки топливного насоса
- CZ Nastavitelný klíč na šrouby palivových nádrží
- HU Üzemanyag jeladó kieszető
- RO Cheie reglabila pt. pompa combustibil pe rezervor
- FR Outil de démontage de pompe
- IT Chiave smontaggio galleggiante serbatoio
- ES Llave de tres garras para afador
- CN 油箱盖拆装工具

24 mm **75-160 mm** **3**



YATO

YT-06288



20

- EN Water pump removal tool set
- PL Zestaw do demontażu pompy wodnej
- DE Demontagesatz für Wasserpumpe
- RU Набор для разборки водяного насоса
- CZ Sada pro demontáž vodního čerpadla
- HU Vízszivattyú leszereő készlet
- RO Set demontat pompa de apa
- FR Kit de démontage de la pompe à eau
- IT Set per rimozione pompa d'acqua
- ES Juego para desmontar la bomba de agua
- CN 大众水泵拆卸组套

4 PCS



VW: Transporter T5, Tuareg
 AXD, AXE, BAC, BLJ, BLK, BPD, BPC, BPE (2003-)

YATO

YT-05390



10

- EN Transmission line disconnect tool set
- PL Zestaw do rozłączania przewodów
- DE Werkzeugsatz zum Trennen von Kraftstoffleitungen
- RU Набор для рассоединения топливopроводов
- CZ Sada na rozpojování palivového potrubí
- HU Üzemanyagcső-lebontó készlet
- RO Set pt. deconectarea liniilor de combustibil
- FR Outil de déconnexion de ligne de transmission de carburant
- IT Set per scollegare i tubi di carburante
- ES Juego para desconectar conductos de combustible
- CN 油管拆卸组套

8 PCS **FOR AIR CONDITIONING DO KLIMATYZACJI** **FOR FUEL LINES DO PRZEWODÓW PALIWA**



YATO

YT-0630



20

- EN Transmission line disconnect tool set
- PL Zestaw do rozłączania przewodów
- DE Werkzeugsatz zum Trennen von Kraftstoffleitungen
- RU Набор для рассоединения топливopроводов
- CZ Sada na rozpojování palivového potrubí
- HU Üzemanyagcső-lebontó készlet
- RO Set pt. deconectarea liniilor de combustibil
- FR Outil de déconnexion de ligne de transmission de carburant
- IT Set per scollegare i tubi di carburante
- ES Juego para desconectar conductos de combustible
- CN 油管拆卸组套

23 PCS **FOR AIR CONDITIONING DO KLIMATYZACJI** **FOR FUEL LINES DO PRZEWODÓW PALIWA**



For fuel lines / Do przewodów paliwa: 5/16" (8 mm), 3/8" (10 mm), 1/2" (12.5 mm), 5/8" (15.9 mm), 3/4" (19 mm), 7/8" (22.2 mm)
For air conditioning / Do klimatyzacji: 3/8" (10 mm), 1/2" (12.5 mm), 5/8" (15.9 mm), 3/4" (19 mm)

YATO

YT-06301



10

- EN Conditioning tool set
- PL Zestaw nasadek do klimatyzacji
- DE Ansatz-Set für Klimaanlage
- RU Набор насадок для системы кондиционирования
- CZ Sada zásuvek pro klimatizaci
- HU Dugókulcs készlet klíma berendezéshez
- RO Set unelte aer conditionat
- FR Ensemble de douille pour la climatisation
- IT Kit di attacchi per impianto aria condizionata
- ES Juego de vasos para el aire acondicionado
- CN 空调修理组套

12 PCS **1/4" 6.3mm** **CrV**



1/4" (6.3 mm): SW12, SW15 (L=40 mm); CrV;
 1/4" (6.3 mm): 2.2, 3.2 mm (L=50 mm); CrV;
 1/4" (6.3 mm);
 1/4" (6.3 mm): TS10, TS15, TS20, TS25, TS27, TS30, TS40 (L=25 mm); CrV

YATO

YT-12007



10/20

- EN Digital thermometer
- PL Termometr elektroniczny z sondą
- DE Elektronisches Thermometer mit Sonde
- RU Электронный термометр с зондом
- CZ Elektronický teploměr se sondou
- HU Elektromos hőmérő szondával
- RO Termometru digital
- FR Thermomètre électronique avec sonde
- IT Termometro elettronico con sonda
- ES Termómetro electrónico con sonda
- CN 电子数显温度计

130 mm **+/- 1 °C** **LCD**
°C -50 +300 **1x LR44**



YATO

YT-72971

L [mm]

130



250

EN Lock-ring pliers
PL Szczypce rozporowe do pierścieni osadzących
DE Spreizzange für Schellen
RU Шплицы распорные для стяжных хомутов
CZ Kleště na hadicové spony
HU Seeger fogó

RO Clește pt. desfacerea brățarelor de strângere
FR Pince tenaille pour les bagues de retenue
IT Pinza per rondelle elastiche scanalata
ES Alicates para abrazaderas
CN C 型扣钳

225
mm

CrV

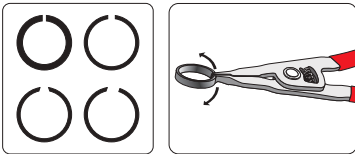

YATO
YT-0607

L [mm]
225

12/72

EN Fuel feel pipe pliers
PL Szczypce do złączek paliwowych
DE Zange für Tankverschlüsse
RU Шплицы для топливных соединений
CZ Kleště na spojku palivového systému
HU Üzemanyagvezeték fogó
RO Clește pt. conectoare de combustibil
FR Pince tenaille pour connecteurs de carburant
IT Pinza per tubo carburante
ES Alicates para enchufes de combustible
CN 油管钳

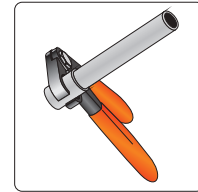

AI



YATO
YT-0608

10

EN Fuel feed pipe remover
PL Szczypce do złączy przewodów paliwowych
DE Zange für Kraftstoffleitungen-Anschlüsse
RU Клеши для разъемов топливных магистралей
CZ Kleště do spojek palivového potrubí
HU Üzemanyagvezeték fogó
RO Extractor conducte de alimentare combustibil
FR Pince à raccord de carburant
IT Pinza per raccordi di tubi carburante
ES Pinzas para conectores de tubos de combustible
CN 汽车油管钳

235
mm

FOR FUEL LINES
DO PRZEWODÓW
PALIWA

SPECIAL
SHAPE
SPECJALNY
KSZTAŁT



YATO
YT-06082

6/24

EN CV boot clamp pliers
PL Szczypce do opasek osłony przegubu
DE Zange für Schellen der Gelenkabdeckung
RU Шплицы для хомутов крепления кожуа шарнира
CZ Kleště na spony manžety kloubu
HU Féltengely bilincs húzó fogó
RO Cleste siguranta burduf planetara
FR Pince pour collier à recouvrement de joint
IT Pinza a morsetto per fascette pinzabili
ES Alicates para abrazadera de protección de la junta
CN 防尘套喉箍夹钳

235
mm

CrV

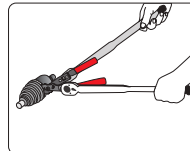
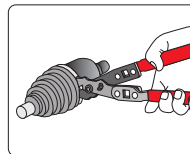

YATO
YT-0606

L [mm]
235

6/36

EN CV boot clamp pliers
PL Szczypce do opasek osłony przegubu
DE Zange für Schellen der Gelenkabdeckung
RU Шплицы для хомутов крепления кожуа шарнира
CZ Kleště na spony manžety kloubu
HU Féltengely bilincs húzó fogó
RO Cleste siguranta burduf planetara
FR Pince pour collier à recouvrement de joint
IT Pinza a morsetto per fascette pinzabili
ES Alicates para abrazadera de protección de la junta
CN 防尘套喉箍夹钳

245
mm



YATO
YT-06061

L [mm]
245

6/36

EN CV boot clamp pliers
PL Szczypce do opasek osłony przegubu
DE Zange für Schellen der Gelenkabdeckung
RU Шплицы для хомутов крепления кожуа шарнира
CZ Kleště na spony manžety kloubu
HU Féltengely bilincs húzó fogó
RO Cleste siguranta burduf planetara
FR Pince pour collier à recouvrement de joint
IT Pinza a morsetto per fascette pinzabili
ES Alicates para abrazadera de protección de la junta
CN 防尘套喉箍夹钳

3/8"
9,5mm

270
mm

0-40
mm

CrMo



YATO
YT-06535

L [mm]
270

5/20

- EN Hose clamp tool
- PL Szczypce do opasek zaciskowych
- DE Schlauchklemmen-Werkzeug
- RU Клещи натяжные для хомутов
- CZ Kleště na hadicové spony
- HU Tömíbilincs fogó
- RO Clema furtun
- FR Pince de serrage
- IT Pinza per fascette
- ES Pinza para abrazaderas
- CN 喉箍拆卸钳

3/8"
9.5 mm **14 mm** **0-40 mm**



YATO
YT-06477 3/8" (9.5 mm) 10/40

- EN CV joint clamp banding tool
- PL Szczypce do opasek przegubów napędowych
- DE Achsmanschetten-Klemm-Zange
- RU Клещи для хомутов сгибов
- CZ Kleště pro montáž manžet homokinetických kloubů
- HU Gumiharang bilincs fogó
- RO Cleste pt. coliere metalice
- FR Pince pour colliers de soufflets de cardan
- IT Pinza stringi fascette per cuffie giunti omocinetici
- ES Alicata para abrazaderas de juntas homocinéticas
- CN 束装钳

max **10 mm** **CUT OFF**
ODCIĘCIE
HARDENED
STEEL
STAL
HARTOWANA



YATO
YT-06062 6/36

- EN CV joint clamp banding tool with ratchet
- PL Szczypce do opasek przegubów napędowych z grzechotką
- DE Achsmanschetten-Klemm-Zange mit Ratsche
- RU Приспособление для установки ленточных хомутов шруса
- CZ Kleště pro montáž manžet homokinetických kloubů s ráčnou
- HU Racsnis gumiharang bilincs fogó
- RO Instrument de fixare a clemelor de articulație cu clichet
- FR Pince pour colliers de soufflets de cardan avec cliquet
- IT Pinza stringi fascette per cuffie giunti omocinetici con cricchetto
- ES Alicata para abrazaderas de juntas homocinéticas con carraca
- CN 防尘套束装钳

max **10 mm** **CUT OFF**
ODCIĘCIE
HARDENED
STEEL
STAL
HARTOWANA



YATO
YT-06064 6/36

- EN Hose removing pliers
- PL Szczypce do zdejmowania przewodów
- DE Schlauch- und Kabellösezange
- RU Клещи для снятия изоляции
- CZ Kleště na demontáž hadic
- HU Tömíbilincs fogó
- RO Clește pt. indepartat furtune
- FR Pince pour enlever les fils
- IT Pinza spelacavi universale
- ES Alicata de extracción de mangueras
- CN 油管分离钳

∅ **5-15 mm**
5-30 mm



YATO
YT-0657 6/36

- EN Spark plug puller set VAG
- PL Zestaw ściągaczy do cewek zapłonowych VAG
- DE Abzieher-Satz Zündspulen VAG
- RU Набор съемников для катушек зажигания VAG
- CZ Sada stahováků zapalovací svíčky
- HU Gyújtótekercs lehűző készlet
- RO Set bobina de aprindeeră tragator
- FR Set d'extracteurs des bobines d'allumage
- IT Set per la rimozione rapida bobine di accensione nelle auto VAG
- ES Extractores bobinas de encendido grupo VAG
- CN 四件套火花塞维修工具

4
PCS **VAG**

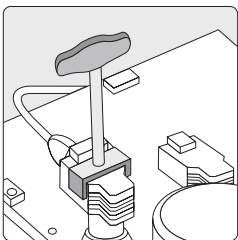

T type 1		Volkswagen FSI Golf / Bora 1998, Polo 2002, Touran 2004, New Beetle 2003, Passat 1997, T4+Audi A2 2001
T type 2		Silniki/engines 6 cyl. 24V, 5 cyl. Golf / Bora 1998, Passat / Touareg 1997, Sharan 1996, Phaeton / Toureg 6 cyl. 2003, T5 z 6 cyl. silnikiem 2004
T type 3		Volkswagen silnik / engines 2.0 z bezp. wtrysk / direct injection, Touran 2004, Passat 2006, Audi z bezp.wtrysk / direct injection A3 2.0 2004, A6 3.2 2005
T type 4		Volkswagen z bezp. wtrysk / direct injection 2.0, Golf / Touran 2004, Passat 2006, Audi z bezp. wtrysk / direct injection, A3 2.0 2004, A6 3.2 2005

VW, Audi, Skoda, Seat

YATO
YT-06205 10

- EN Multi-purpose hose & wire pliers
- PL Komplet szczypiec do opasek i przewodów
- DE Zangensatz für Schellen und Leitungen
- RU Набор щипцов к хомутам и проводам
- CZ Souprava kleští na spony a hadice
- HU Fogókészlet bilincsekhez és vezetékhez
- RO Set clește pt. benzi și conducte
- FR Pince pour collier de serrage
- IT Set pinze per il morsetto
- ES Juego de pinzas para abrazaderas y cables
- CN 多功能管夹钳



2 PCS	1/4" 6.3mm	3/4" 19mm	217 mm	254 mm	
----------	---------------	--------------	-----------	-----------	--

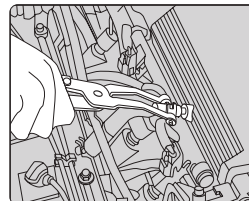

FOR ENGINE AIR PIPE
DO PRZEWODÓW POWIETRZNYCH LISTWY WTRYKOWEJ

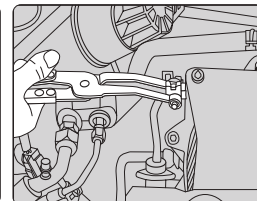

FOR ENGINE INTAKE AIR PIPE
DO PRZEWODÓW GUMOWYCH UKŁADU ZASILANIA

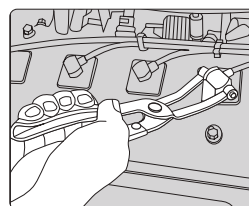

FOR SPARK PLUG LEAD
DO PRZEWODÓW ZAPŁONOWYCH

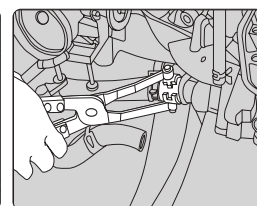

FOR COOLING WATER PIPE
DO PRZEWODÓW GUMOWYCH UKŁADU CHŁODZENIA

YATO	L [mm]	
YT-0645	217, 254	6/24

- EN Hose clamp pliers
- PL Szczypce do opasek zaciskowych rozprężnych
- DE Zange zum Entspannen der Klemmschellen
- RU Щипцы к хомутам зажимным распорным
- CZ Kleště na samosvorné hadicové spony
- HU Vízcsőbilincs fogó
- RO Clește pt. benzile de strângere destindere
- FR Pince pour collier de serrage
- IT Set pinze per il morsetto
- ES Pinzas para las abrazaderas de expansión
- CN 管夹钳

	215 mm	\varnothing 2.0 mm
LOCK BLOKADA	AISI 4130	

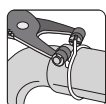

YATO	L [mm]	
YT-0646	215	12/72

- EN Hose clamp pliers
- PL Szczypce do opasek zaciskowych rozprężnych
- DE Zange zum Entspannen der Klemmschellen
- RU Щипцы к хомутам зажимным распорным
- CZ Kleště na samosvorné hadicové spony
- HU Vízcsőbilincs fogó
- RO Clește pt. benzile de strângere destindere
- FR Pince pour collier de serrage
- IT Set pinze per il morsetto
- ES Pinzas para las abrazaderas de expansión
- CN 管夹钳

230 mm	\varnothing 4mm	\varnothing 12mm
HRC 40	LOCK BLOKADA	

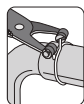

YATO	L [mm]	
YT-0650	230	6/36

- EN Hose clamp pliers
- PL Szczypce do opasek zaciskowych rozprężnych
- DE Zange zum Entspannen der Klemmschellen
- RU Щипцы к хомутам зажимным распорным
- CZ Kleště na samosvorné hadicové spony
- HU Vízcsőbilincs fogó
- RO Clește pt. benzile de strângere destindere
- FR Pince pour collier de serrage
- IT Set pinze per il morsetto
- ES Pinzas para las abrazaderas de expansión
- CN 管夹钳

	215 mm	\varnothing 4.5 mm
LOCK BLOKADA	AISI 4130	

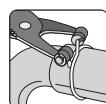

YATO	L [mm]	
YT-0647	215	12/72

- EN Hose clamp pliers
- PL Szczypce do opasek zaciskowych rozprężnych
- DE Zange zum Entspannen der Klemmschellen
- RU Щипцы к хомутам зажимным распорным
- CZ Kleště na samosvorné hadicové spony
- HU Vízcsőbilincs fogó
- RO Clește pt. benzile de strângere destindere
- FR Pince pour collier de serrage
- IT Set pinze per il morsetto
- ES Pinzas para las abrazaderas de expansión
- CN 弯嘴管夹钳

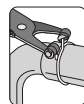

	215 mm	\varnothing 4mm	\varnothing 12mm
LOCK BLOKADA	HRC 40		

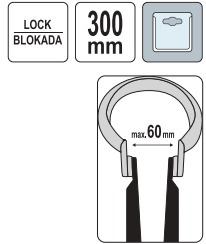

YATO	L [mm]	
YT-0651	215	6/36

- EN Exhaust pipe clamp pliers
- PL Szczypce do opasek wydechu
- DE Auspuffschellen-Sicherungszange
- RU Щипцы для пружинных зажимов
- CZ Kleště na spony výfuku
- HU Kipufogóbilincs fogó
- RO Clește pt. coliere teava de esapament
- FR Pince pour collier d'échappement
- IT Set pinze per il morsetto
- ES Pinzas para bridas del tubo de escape
- CN 排气管夹钳



YATO 	L [mm]	
YT-0652	300	10/20

 Peugeot, Citroën, Renault, Fiat, Ford

- EN Valve stem seal pliers
- PL Szczypce do uszczelniaczy zaworowych, długie
- DE Lange Zange für Ventildichtringe
- RU Щипцы для замены масляных колпачков
- CZ Kleště na těsnění ventilů, dlouhé
- HU Szelepszár szimering fogó hosszú

- RO Clește cu picior lung pt. sigilat supape
- FR Pince pour joints de queues de soupapes
- IT Pinza per tenuta anello stelo valvola
- ES Pinzas para juntas de vástago válvula
- CN 气门油封钳



YATO 	L [mm]	
YT-0648	270	12/60



- EN Pliers for band clips with a cord
- PL Szczypce z linką do opasek zaciskowych
- DE Zange für Rohrschellen mit Seil
- RU Щипцы к зажимным хомутам с тросиком
- CZ Kleště s lankem na samosvorné hadicové spony
- HU Flexibilis bowdenes vízcsőbilincs fogó
- RO Clește pt. cleme de prindere frânghie
- FR Pince pour collier de serrage
- IT Pinza per il montaggio e lo smontaggio delle clips elastiche
- ES Pinzas para bandas de apretadura con cuerda
- CN 延长型弹性管夹钳

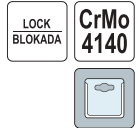

YATO 	L [mm]	
YT-0653	210	12/36

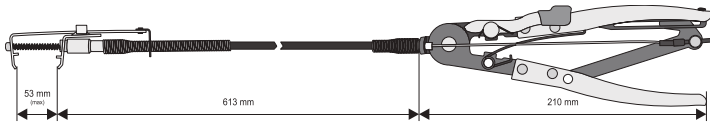

- EN Pliers for band clips with a cord
- PL Szczypce z linką do opasek zaciskowych
- DE Zange für Rohrschellen mit Seil
- RU Щипцы к зажимным хомутам с тросиком
- CZ Kleště s lankem na samosvorné hadicové spony
- HU Flexibilis bowdenes vízcsőbilincs fogó
- RO Clește pt. cleme de prindere frânghie
- FR Pince pour collier de serrage
- IT Pinza per il montaggio e lo smontaggio delle clips elastiche
- ES Pinzas para bandas de apretadura con cuerda
- CN 延长型弹性管夹钳



YATO 	L [mm]	
YT-0677	210	25

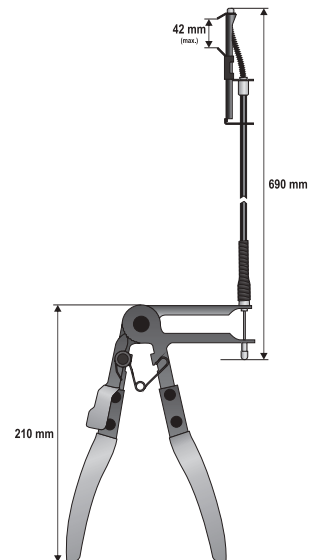

- EN Hose clip pliers
PL Szczypce do opasek zaciskowych typu CLIC i CLIC-R
DE Schlauchklemmzange
RU Плоскогубцы для зажима шлангов хомуты, CLIC-R
CZ Kleště na hadicové spony
HU Tömítőbilincs fogó
RO Clește furtun clip
FR Pince pour collier de serrage
IT Pinza per fascetta a CLIC e CLIC-R
ES Alicates abrazaderas
CN 压线钳

170
mm

CLIC
CLIC-R



YATO
YT-06475 L [mm] 170 10/60

- EN Tensioner pulley wrench
PL Klucz do rolki napinającej
DE Zahnriemen Spannrollenschlüssel
RU Ключ для регулировки натяжного
CZ Klíč na naplnák
HU Bordás szjű feszítő

- RO Cheie de pretensionare a centurilor
FR Clé pour rouleau de tension
IT Chiave per il rullo tenditore
ES Llave del tensor de la correa dentada
CN 滑轮定时扳手

32
mm



YATO
YT-06273 20/100

- EN Universal pulley holder & fan clutch set
PL Klucz do napinania koła pasowego
DE Schlüssel zum Spannen der Riemenscheibe
RU Ключ для натяжения шкива
CZ Klíč k naplnání řemenice
HU Szijjárcsa feszítő kulcs

- RO Cheie pt. întindere roată de curea
FR Clé universelle pour poulie
IT Blocca puleggia
ES Llave tensoradora para polea
CN 多用途皮带轮扳手

11
PCS

6-10
mm

8-11
mm

10-12
mm

11-16
mm

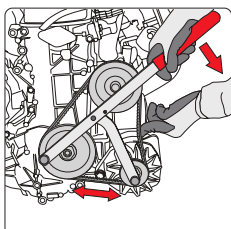

Ø 6-10 mm, Ø 8-11 mm, Ø 10-12 mm, Ø 11-16 mm

YATO
YT-0627 8

- EN Serpentine belt tool set
PL Zestaw kluczy do napinaczy
DE Spannrollen-Schlüssel-Satz
RU Набор ключей для натяжения ремня
CZ Sada klíčů na naplnací kladky
HU Ékszij feszítő kulcs készlet
RO Cheie pt. curea de distributie
FR Jeu de clés pour tendeurs
IT Set di chiavi per tendicinghia
ES Juego de llaves para tensores
CN 惰性皮带扳手调整组

8
PCS

3/8"
9.5 mm

1/2"
12.7 mm

CrV



- 3/8" (9.5 mm): 15, 16, 18 mm; CrV;
3/8" (9.5 mm): 13, 14, 15 mm; CrV;
590 mm

YATO
YT-06278 6/12

- EN Timing belt double pin wrenches tool set for VAG
PL Zestaw do obsługi rolek napinaczy VAG
DE Kit für die Bedienung von VAG-Spannrollen
RU Комплект для обслуживания роликов натяжителя VAG
CZ Sada pro údržbu napinacích kladek VAG
HU VAG feszítógörgő szervizelő készlet
RO Trusa si chei de curele VAG
FR Kit d'extraction de coussinet VAG
IT Set di attrezzi per rulli tenditori VAG
ES Juego para rodillos tensores VAG
CN 大众奥迪正时皮带双销扳手套装

6
PCS

VAG



YATO
YT-06275 5

- EN Stretch fit belt tool kit
PL Zestaw do obsługi pasek elastycznych wielorowkowych
DE Werkzeugsatz für elastische Keilrippenriemen
RU Набор для использования гибких многоканавочных ремней
CZ Sada pro manipulaci s elastickými vicedrážkovými řemeny
HU Készlet több bordás ékszij kezeléséhez
RO Set catarame strangere centura scule
FR Ensemble pour le montage et démontage des courroies élastiques à nervures multiples en V
IT Kit per montaggio / smontaggio delle cinghie elastiche
ES Kit de montaje de correas elásticas ranuradas
CN 正时皮带拆装辅助器

2
PCS

FOR ELASTIC STRAPS DO PASKÓW ELASTYCZNYCH ASSEMBLY DISASSEMBLY MONTAZ DEMONTAZ



YATO
YT-05830 20/80

- EN Piston ring compressor
- PL Zaciskacz do pierścieni
- DE Kolbenring-Spannband
- RU Оправка поршневых колец
- CZ Svěrka na kroužky
- HU Gyűrűbepattintó
- RO Clește pt. strâns inele
- FR Compresseur de segments de piston
- IT Morsetto per anelli
- ES Apretador de anillos
- CN 活塞环压缩机



SK5 AISI 301

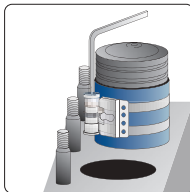

YATO	Ø [mm]	H [mm]	
YT-0635	50-125	75	30/60
YT-0636	90-175	100	30/60
YT-0637	90-175	150	20/40

- EN Piston rings pliers
- PL Szczypce do pierścieni tłokowych
- DE Kolbenringe Zange
- RU Клещи для установки поршневых колец
- CZ Kleště na pístní kroužky
- HU Dugattyúgyűrű fogók
- RO Cleste pt. inelul de piston
- FR Pince pour anneau de piston
- IT Pinze per anelli di pistoni
- ES Alicates de anillo de pistón
- CN 活塞环钳



40-100 mm

YATO	
YT-06377	5/50

- EN Piston ring tool set
- PL Zestaw do obsługi pierścieni tłokowych
- DE Kolbenring-Wartungssatz
- RU Набор для обслуживания поршневых колец
- CZ Sada pro údržbu pístních kroužků
- HU Dugattyúgyűrű-szerelő készlet
- RO Set unelte pt. inel piston
- FR Kit d'outils d'entretien de segment de piston
- IT Set di attrezzi per fasce elastiche
- ES Kit de ensamblaje de anillos de pistón
- CN 活塞环拆装套装



10 PCS 50-100 mm

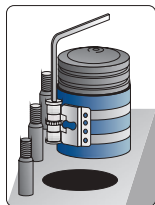

75 x 50-125 mm, 100 x 60-175 mm, 130 x 60-175 mm

YATO	Ø [mm]	
YT-06373	50-125, 60-175, 60-175	4

- EN Cylinder honing machine
- PL Honownica do cylindrów
- DE Ziehschleifmaschine für Motorenzylinder
- RU Хонинговальный станок
- CZ Valcový honovací stroj
- HU Henger hónoló
- RO Mașină de honuit cilindri
- FR Machine à roder des cylindres
- ES Máquina herramienta para afilar los cilindros
- CN 气缸打磨器

x3 ADJUSTABLE TENSION REGULOVANÝ NÁČEK FLEXIBLE SHAFT ELASTIČNÝ WALEK



19-63 mm 205 mm 28x6 mm

YATO	L [mm]	
YT-05810	205	50/100



32-89 mm 230 mm 51x7 mm

YATO	L [mm]	
YT-05811	230	50/100



51-177 mm 305 mm 76x10 mm

YATO	L [mm]	
YT-05812	305	5/20

- EN Interchangeable stones for honing machine
- PL Kamienie wymienne do honownicy
- DE Wechschleifsteine für die Ziehschleifmaschine
- RU Сменный брусок для хонинговального станка
- CZ Výmenné kameny do honovacího stroje
- HU Cserélhető kövek a hónolóhoz
- RO Pietre intersanjabile pt. mașina de honuit
- FR Pierres interchangeable de la machine à roder
- ES Piedras intercambiables a la máquina herramienta para afilar cilindros
- CN 磨石

3 PCS

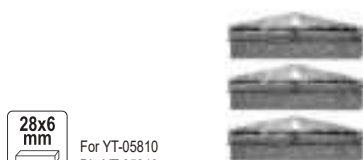

28x6 mm For YT-05810 Dla YT-05810

YATO	
YT-05815	50/200



51x7 mm For YT-05811 Dla YT-05811

YATO	
YT-05816	50/200



76x10 mm For YT-05812 Dla YT-05812

YATO	
YT-05817	50/100

EN Cylinder hone tool set
PL Zestaw do honowania cylindrów
DE Zylinder-Honwerkzeug-Satz
RU Набор для хонингования цилиндров
CZ Sada pro honování válců
HU Hengerhónoló készlet
RO Kit pt. șlefuit cilindri
FR Jeu de pierrage de cylindres
IT Set lappatore per cilindri
ES Kit de lapeadores de cilindros
CN 气缸打磨器



7 PCS	\varnothing 51-177 mm	FLEXIBLE SHAFT ELASTYCZNY WALEK	101x11 mm	102x11 mm
P100	P220	P400		

P100 11x102 mm (3 PCS), P220 11x101 mm (3 PCS), P400 11x101 mm (3 PCS)

YATO  **YT-05801**  10

EN Cylinder hone tool set
PL Zestaw do honowania cylindrów
DE Zylinder-Honwerkzeug-Satz
RU Набор для хонингования цилиндров
CZ Sada pro honování válců
HU Hengerhónoló készlet
RO Kit pt. șlefuit cilindri
FR Jeu de pierrage de cylindres
IT Set lappatore per cilindri
ES Kit de lapeadores de cilindros
CN 气缸打磨器



7 PCS	\varnothing 20-50 mm	\varnothing 25-70 mm	\varnothing 32-89 mm	\varnothing 51-177 mm
FLEXIBLE SHAFT ELASTYCZNY WALEK	28x5 mm	50x7 mm	76x10 mm	100x11 mm
			P220	

P220 5x28 mm (5 PCS), P220 7x50 mm (3 PCS), P220 10x76 mm (3 PCS), P220 11x100 mm (3 PCS)



YATO  **YT-05802**  10

EN Cylinder hone tool set
PL Zestaw do honowania cylindrów
DE Zylinder-Honwerkzeug-Satz
RU Набор для хонингования цилиндров
CZ Sada pro honování válců
HU Hengerhónoló készlet
RO Kit pt. șlefuit cilindri
FR Jeu de pierrage de cylindres
IT Set lappatore per cilindri
ES Kit de lapeadores de cilindros
CN 气缸打磨器



14 PCS	\varnothing 20-50 mm	\varnothing 25-70 mm	\varnothing 32-89 mm	FLEXIBLE SHAFT ELASTYCZNY WALEK
	28x5 mm	50x7 mm	P220	

P220 5x28 mm (8 PCS), P220 7x50 mm (3 PCS)

YATO  **YT-05800**  10

EN Belt gauge
 PL Przyrząd do kontroli naciągu paska rozrządu
 DE Werkzeug Spannungsprüfer
 RU Прибор для проверки натяжения ремней
 CZ Připravek pro kontrolu napnutí rozvodového řemene
 HU Méter szíjfeszességet
 RO Tester întindere curea de distribuție cu gradatie
 FR Controleur de tension de courroie
 IT Strumento per il controllo rapido della tensione cinghia distribuzione
 ES Medidor para determinar la tensión de la correa
 CN 皮带张紧器

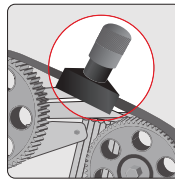

YATO
 YT-06019

20

EN Special socket antechamber injection pump
 PL Nasadka do komory wstępnej wtryskowej
 DE Kerbzahn-Einsatz für Vorkammer-Muttern an Dieselmotoren
 RU Сервисный ключ для форкамера
 CZ Klíč pro vstřikovací čerpadla
 HU Dugókulcs befecskendező szivattyúhoz
 RO Tubulara speciala pt. anticamera pompa de injectie motoare
 FR Douille spéciale pipe d'admission
 IT Bussola per precamera
 ES Llave de vaso con dentado exterior para cámara de precombustión
 CN 奔驰火花塞外套筒



1/2"
 12.7mm

Ø
 28 mm

MERCEDES



YATO
 YT-12005

15/60

EN Twin cam locking tool for petrol & diesel engines
 PL Uniwersalna blokada wałków rozrządu
 DE Universelle Blockade der Steuerwellen
 RU Универсальный набор блокировки распределителя
 CZ Univerzální přípravek na zablkování rozvodných hřídelí
 HU Univerzális vezérműtengely rögzítő
 RO Dispozit universal blocare distributie
 FR Outil de blocage d'arbre à cames
 IT Universale strumento di bloccaggio a camme
 ES Bloqueo universal de eje de distribución
 CN 凸轮止锁工具



DOHC
 FOR DIESEL ENGINES DO SILNIKÓW DIEŚLA
 FOR GASOLINE ENGINES DO SILNIKÓW BENZYNOWYCH

YATO
 YT-17527

20

VAG
 1.4 I, 1.6 I, 2.0 I TDI



15 mm

VAG

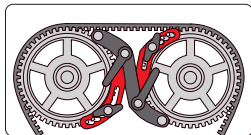

YATO
 YT-06008

10

EN Twin cam locking tool for petrol & diesel engines
 PL Uniwersalna blokada wałków rozrządu
 DE Universelle Blockade der Steuerwellen
 RU Универсальный набор блокировки распределителя
 CZ Univerzální přípravek na zablkování rozvodných hřídelí
 HU Univerzális vezérműtengely rögzítő

RO Dispozit universal blocare distributie
 FR Outil de blocage d'arbre à cames
 IT Universale strumento di bloccaggio a camme
 ES Bloqueo universal de eje de distribución
 CN 双凸齿轮固定器

FOR DIESEL ENGINES DO SILNIKÓW DIEŚLA

FOR GASOLINE ENGINES DO SILNIKÓW BENZYNOWYCH



EN Diesel engine locking setting kit
 PL Blokada do kół rozrządu
 DE Blockade für Steueräder
 RU Блокировка к колесам распределительных механизмов
 CZ Souprava na fixaci rozvodových kol
 HU Diesel motor rögzítő készlet
 RO Blocadă roților distribuție
 FR Outil de blocage d'arbre à cames
 IT Cinghia di distribuzione di bloccaggio
 ES Bloqueo para las poleas del mecanismo de distribución
 CN 正时皮带更换工具

3 PCS

FOR VALVETRAIN ROZRZĄDU

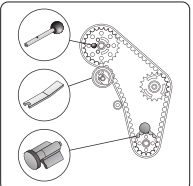

VW: Lupo, Polo, Golf, Bora, Beetle, Caddy, Sharan, Touran, Transporter (1998-2006);
 Audi: A2, A3, A4, A6; Ford: Galaxy (2000-2006);
 Seat: Arosa, Ibiza, Cordoba, Leon, Toledo, Alhambra (1999-2005); Skoda: Fabia, Octavia (2000-2006)
 3 i 4 cyl 1.2, 1.4, 1.9 TDI PD, 2.0 SDI, 2.0 TDI PD

YATO
 YT-0632

10/50

YATO
 YT-06011

10/20

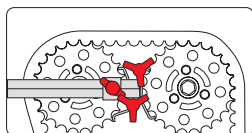

EN Timing locking set
PL Zestaw blokad rozrządu
DE Nockenwellen-Arretierwerkzeugsatz
RU Комплект блокировки газораспределения
CZ Blokovací sada pro opravy rozvodů
HU Vezérműrögztítő szerszámkészlet

RO Set blocare distribuție auto
FR Jeu d'outils de calage de distribution
IT Set di bloccaggio distribuzione auto
ES Juego de bloques de distribución
CN 引擎正时工具

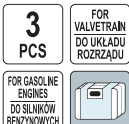

Peugeot: 208 1.0/1.2 VTI 2008; Citroen: C3 1.0/1.2 VTI 2012
EBO (ZMZ), EB2 (HMZ)

YATO
YT-06023 5

EN Timing locking set
PL Zestaw blokad rozrządu
DE Nockenwellen-Arretierwerkzeugsatz
RU Комплект блокировки газораспределения
CZ Blokovací sada pro opravy rozvodů
HU Vezérműrögztítő szerszámkészlet

RO Set blocare distribuție auto
FR Jeu d'outils de calage de distribution
IT Set di bloccaggio distribuzione auto
ES Juego de bloques de distribución
CN 引擎正时工具



Renault: Twingo, Clio, Kangoo, Megane, Scenic, Laguna, Espace 1.2, 1.4, 1.6, 1.8, 2.0 16V (98-06), 1.5dCi;
Nissan: Micra 1.5dCi, Kubistar 1.6 16V (03-06); Opel: Vivaro 2.0 16V (01-06)
Renault: D4F, K4J, K4M, F4P, F4R, F4Rt, F5R740, K9K; Nissan: K9K, K4M; Opel: F4R720

YATO
YT-06014 10

EN Timing locking set
PL Zestaw blokad rozrządu
DE Nockenwellen-Arretierwerkzeugsatz
RU Комплект блокировки газораспределения

CZ Blokovací sada pro opravy rozvodů
HU Vezérműrögztítő szerszámkészlet
RO Set blocare distribuție auto
FR Jeu d'outils de calage de distribution

IT Set di bloccaggio distribuzione auto
ES Juego de bloques de distribución
CN 引擎正时工具



- Camshaft locking pin
- Crankshaft locking pin
- 2 camshaft locking clamps
- Trzpień blokujący wałek rozrządu
- Trzpień blokujący wał korbowy
- 2 zaciski blokujące walki rozrządu

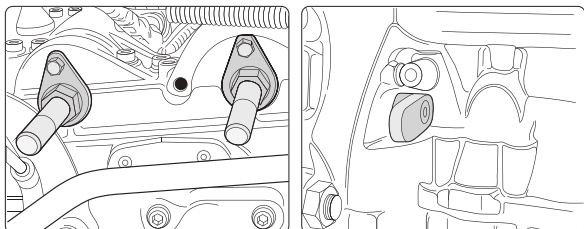

VW, Skoda, Seat 1.2 12V and 1.2 6V (HTP); VW: Polo; Seat: Ibiza, Cordoba; Skoda: Fabia HTP
AZQ, AWY, BMD, BME (02-07)

EN Timing locking set
PL Zestaw blokad rozrządu
DE Nockenwellen-Arretierwerkzeugsatz
RU Комплект блокировки газораспределения
CZ Blokovací sada pro opravy rozvodů
HU Vezérműrögztítő szerszámkészlet

RO Set blocare distribuție auto
FR Jeu d'outils de calage de distribution
IT Set di bloccaggio distribuzione auto
ES Juego de bloques de distribución
CN 引擎正时工具



Audi: A3 (03-10); Seat: Altea, Ibiza, Leon; Skoda: Fabia II (07-09), Octavia (04-09), Roomster (06-09), Superb (09-10); VW: Eos (06-09), Golf (03-09), Golf Plus (05-09), Jetta (06-09), Passat (05-09), Polo (02-08), Scirocco (09-10), Tiguan (07-09), Touran (03-09)
1.4 FSI (AXU, BKG, BLN), 1.4 TFSI (BLG, BMY, BWK, CAVA, CAVB, CAVC, CAVD, CAVF, CAXA, CAXC, CDGA), 1.6 FSI (BAG, BLF, BLP, BTS)

YATO
YT-06017 10

EN Timing locking set
PL Zestaw blokad rozrządu
DE Nockenwellen-Arretierwerkzeugsatz
RU Комплект блокировки газораспределения
CZ Blokovací sada pro opravy rozvodů
HU Vezérműrögztítő szerszámkészlet

RO Set blocare distribuție auto
FR Jeu d'outils de calage de distribution
IT Set di bloccaggio distribuzione auto
ES Juego de bloques de distribución
CN 引擎正时工具

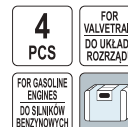

BMW: E30 318iS, E34 520i, E34 525i/525xi, E34 Serie 5, E36 318i/318iS/318ti, Z3 1.9, E36 320i, E36 Serie 3, E36 325i/325is, E36 Z3 2.2i, E36 M3, E36/7 Z3 2.5i, E36 Z3 3.0i, E36/E46 328i, E39 520i, E39 525i, E39 528i, E39 530i, E46 320i/320Ci, E46 325i/325xi, E46 325Ci, E46 325ti, E46 330i/330xi, E46 330Ci, E53 X5 3.0i, E60 530i, E60/E61 520i, E60/E61 525i/525xi, E85 Z4 2.5i, E83 X3 2.5i, E83 X3 3.0i, E85 Z4 2.2i, E85 Z4 3.0i
M42B18, M44B19, M50B20, M50B24, M50B25, M52B21, S50B30US, M54B22, M54B25, M54B30

YATO
YT-06332 10

EN Timing locking set
 PL Zestaw blokad rozrządu
 DE Nockenwellen-Arretierwerkzeugsatz
 RU Комплект блокировки газораспределения
 CZ Blokovací sada pro opravy rozvodů
 HU Vezérműrögztítő szerszámkészlet

RO Set blocare distribuție auto
 FR Jeu d'outils de calage de distribution
 IT Set di bloccaggio distribuzione auto
 ES Juego de bloques de distribución
 CN 引擎正时工具



4
PCS

FOR VALVETRAIN DO UKŁADU ROZRZĄDU

FOR DIESEL ENGINES DO SILNIKÓW DIELSA

FOR GASOLINE ENGINES DO SILNIKÓW BENZYNOWYCH



 Dacia: Duster (2010-2014), Logan & Logan MCV (2005-2013), Sandero (2008-2013); Nissan: Kubistar (2003-2009), Primastar (2002-2011); Opel: Vivaro (2002-2011); Renault: Avantime (2000-2003), Clio II (1998-2010), Clio III (2005-2013), Espace III (1998-2003), Espace IV (2002-2010), Kangoo (2001-2008), Kangoo II (2008-2013), Laguna (1998-2001), Laguna II (2001-2007), Laguna III (2007-2013), Megane & Megane Scenic (1999-2003), Megane II (2002-2009), Megane III (2008-2013), Modus (2004-2008), Modus & Grand Modus II (2008-2013), Scenic (1999-2003), Scenic & Grand Scenic II (2002-2009), Scenic & Grand Scenic III (2009-2013), Trafic II (2001-2011), Twingo II (2007-2014), Vel Satis (2000-2010)
 Nissan: K9K, K4M; Opel: FR4 720; Renault: D4F, K4J, K4M, F4P F4R, F4Rt, F5R740, K9K

YATO  **YT-06326**  4

EN Timing locking set
 PL Zestaw blokad rozrządu
 DE Nockenwellen-Arretierwerkzeugsatz
 RU Комплект блокировки газораспределения
 CZ Blokovací sada pro opravy rozvodů
 HU Vezérműrögztítő szerszámkészlet
 RO Set blocare distribuție auto
 FR Jeu d'outils de calage de distribution
 IT Set di bloccaggio distribuzione auto
 ES Juego de bloques de distribución
 CN 引擎正时工具





5
PCS

FOR VALVETRAIN DO UKŁADU ROZRZĄDU

FOR GASOLINE ENGINES DO SILNIKÓW BENZYNOWYCH



 Fiat: 500, Panda, Punto, Grande Punto, Albea, Linea, Bravo, Brava, Palio, Idea, Weekend, Siena, Stilo, Marea (97-10); Lancia: Ypsilon, Musa (96-10)
 1.2 16V: 176B9.000, 182B2.000, 188A5.000; 1.4 16V: 843A1.000, 169A3.000, 192B2.000, 198A1.000, 198A4.000, 199A6.000

YATO  **YT-06016**  10

EN Timing locking set
 PL Zestaw blokad rozrządu
 DE Nockenwellen-Arretierwerkzeugsatz
 RU Комплект блокировки газораспределения
 CZ Blokovací sada pro opravy rozvodů
 HU Vezérműrögztítő szerszámkészlet
 RO Set blocare distribuție auto
 FR Jeu d'outils de calage de distribution
 IT Set di bloccaggio distribuzione auto
 ES Juego de bloques de distribución
 CN 引擎正时工具







5
PCS

FOR VALVETRAIN DO UKŁADU ROZRZĄDU

FOR GASOLINE ENGINES DO SILNIKÓW BENZYNOWYCH



 Opel: Agila, Astra G/H, Corsa, Corsa B, Combo C, Meriva, Tigra B
 1.0 12V, 1.0 16V, 1.2 16V, 1.4 16 V (chain); X10XE, Z10XE, Z10XEP, X12XE, Z12XE, Z14XEP

YATO  **YT-06002**  10

EN Timing locking set
 PL Zestaw blokad rozrządu
 DE Nockenwellen-Arretierwerkzeugsatz
 RU Комплект блокировки газораспределения
 CZ Blokovací sada pro opravy rozvodů
 HU Vezérműrögztítő szerszámkészlet

RO Set blocare distribuție auto
 FR Jeu d'outils de calage de distribution
 IT Set di bloccaggio distribuzione auto
 ES Juego de bloques de distribución
 CN 引擎正时工具





5
PCS

FOR VALVETRAIN DO UKŁADU ROZRZĄDU

FOR BMW DIESEL ENGINES DO SILNIKÓW DIELSA BMW



 BMW: 520i E60 (04-08), Z4 2.0 E85 (04-08), X3 2.0i E83 (05-08), 118i E87 (04-07), 120i E87 (04-07), 316i E46 (01-05), 316 ti Compact E46 (04-05), 318i E46 (01-07), 318i Compact E46 (01-05), 318i E90 (05-08), 320i E90 (05-08), 116i E81/E87 (03-08), 316i E46/E90 (01-08), 316Ci E46 (01-05), 128i E82 (07-08), 130i E81/E87 (05-08), 135iS E82 (07-08), 323i E90/91/92/93 (04-08), 325i/xi E90/91/92/93 (04-08), 328i/xi E90/91/92/93 (04-08), 330i/xi E90/91/92/93 (04-08), 335i/xi E90/91/92/93 (05-08), 523i/Li E60/E61 (04-08), 525 i/Li/xi E60/E61 (04-08), 528i/xi E60/E61 (06-08), 530i/xi E60/E61 (05-08), 535i/xi E60/E61 (06-08), X5 3.0 E70 (06-08), Z4 2.5/3.0 E85/E6 (05-08), 630 E63/E64 (04-08), 730i/Li E65/E66 (04-08), X3 2.5/3.0 E83 (06-08); BMW Mini: R55, R56 Cooper S (06-09), R56 Mini One (07-09); Peugeot: 207, 207 CC, 308 (07-09); Citroën: C4, C4 Picasso (08-09)
 N22/B12: N24-B18A, B20A, B20B; N40/N45/N45T/B16, N51/N52/N52K/N53/N54/N53/N54 (direct injections), N12/N14: EP3 (8FS), EP6 (5FW), EP6DT (5FX), EP6DTS (5FY); OEM: OEM119280, OEM115140, OEM113340, OEM119330

YATO  **YT-06004**  5

EN Timing locking set
PL Zestaw blokad rozrządu
DE Nockenwellen-Arretierwerkzeugsatz
RU Комплект блокировки газораспределения
CZ Blokovačí sada pro opravy rozvodů
HU Vezérműrögztűlő szerszámkészlet

RO Set blocare distribuție auto
FR Jeu d'outils de calage de distribution
IT Set di bloccaggio distribuzione auto
ES Juego de bloques de distribución
CN 引擎正时工具



6
PCS

VAG

FOR VALVETRAIN DO UKŁADU ROZRZĄDU

FOR GASOLINE ENGINES DO SILNIKÓW BENZYNOWYCH

Audi: A3 (since 2013) 1.2/1.4 TSI; Skoda: Citigo 1.0/1.0 Ecofuel/1.0 Green Tech, Octavia (since 2013); Seat: Leon (since 2013), Mii 1.0/1.0 Ecofuel/1.0 Ecomotive; VW: Golf VII (since 2012), Jetta (since 2012), Up 1.0/1.0 BlueMotion/1.0 Ecofuel

1.0 CHYA, CHYB, CPGA, 1.2 TFSI: CJZA, CJZB, 1.4 TFSI: CMBA, CXSA, CHPA, 1.4 TGI: CPWA, 1.4 TSI Multi Fuel CPVA, CZDA, CZDB, CZDC, 1.4 Hybrid CRJA

YATO
YT-06025

4

EN Timing locking set
PL Zestaw blokad rozrządu
DE Nockenwellen-Arretierwerkzeugsatz
RU Комплект блокировки газораспределения
CZ Blokovačí sada pro opravy rozvodů
HU Vezérműrögztűlő szerszámkészlet

RO Set blocare distribuție auto
FR Jeu d'outils de calage de distribution
IT Set di bloccaggio distribuzione auto
ES Juego de bloques de distribución
CN 引擎正时工具



6
PCS

VAG

FOR VALVETRAIN DO UKŁADU ROZRZĄDU

FOR GASOLINE ENGINES DO SILNIKÓW BENZYNOWYCH

Fiat: 500, Panda, Punto (10-16)
 312 A2 000, 312 A4 000, 312 A6 000, 199 B6 000 etc.

YATO
YT-06331

10

EN Timing locking set
PL Zestaw blokad rozrządu
DE Nockenwellen-Arretierwerkzeugsatz
RU Комплект блокировки газораспределения
CZ Blokovačí sada pro opravy rozvodů
HU Vezérműrögztűlő szerszámkészlet
RO Set blocare distribuție auto
FR Jeu d'outils de calage de distribution
IT Set di bloccaggio distribuzione auto
ES Juego de bloques de distribución
CN 引擎正时工具

RO Set blocare distribuție auto
FR Jeu d'outils de calage de distribution
IT Set di bloccaggio distribuzione auto
ES Juego de bloques de distribución
CN 引擎正时工具



6
PCS

VAG

FOR VALVETRAIN DO UKŁADU ROZRZĄDU

FOR DIESEL ENGINES DO SILNIKÓW DIELSA

Audi: A1, A1 Sportback, A3, A3 Cabrio, A3 Saloon, A3 Sportback, A4, A4 Allroad, A4 Quattro, A5, A5 Cabriolet, A5 Coupe, A5 Sportback, A6, TT, Q3, Q5; Seat: Alhambra, Ibiza, Leon, Leon ST; Skoda: Fabia III, Fabia III Estate, Octavia III, Rapid, Rapid Spaceback, Superb III; VW: Golf VI, Golf VII, Golf VII Estate, Golf VII SV/Sportsvan, Passat, Polo, Scirocco, Sharan II, Touran II, Tiguan

1.4: CUSA, CUSB, CUTA; 1.6: CLHA, CLHB, CRKA, CRKB, CXXA, CXXB; 2.0: CKFB, CKFC, CRBC, CRBD, CRFA, CRFC, CRMB, CRLB, CRLC, CRVA, CRVC, CUAA, CUNA, CUPA, CUUA, CUUB, CUWA, DDA, CNHA, CNHC, CSUA, CSUB, CSUD, CSUE

YATO
YT-060176

10

EN Timing locking set
PL Zestaw blokad rozrządu
DE Nockenwellen-Arretierwerkzeugsatz
RU Комплект блокировки газораспределения
CZ Blokovačí sada pro opravy rozvodů
HU Vezérműrögztűlő szerszámkészlet
RO Set blocare distribuție auto
FR Jeu d'outils de calage de distribution
IT Set di bloccaggio distribuzione auto
ES Juego de bloques de distribución
CN 引擎正时工具

RO Set blocare distribuție auto
FR Jeu d'outils de calage de distribution
IT Set di bloccaggio distribuzione auto
ES Juego de bloques de distribución
CN 引擎正时工具



6
PCS

VAG

FOR VALVETRAIN DO UKŁADU ROZRZĄDU

FOR DIESEL ENGINES DO SILNIKÓW DIELSA

Opel: Astra, Vectra, Signum, Zafira, 1.9 CDTi (04-06); Fiat: 1.9, 2.4 JTD; 16V, 20V; Alfa Romeo: 147, 156, GT 1.9 JTD 16V, 2.4 JTD 20V
 Z19DTH, Z19DT, 192 A5.000, 192 B1.000, 937 A4.000, 937 A5.000



YATO
YT-06013

10

- EN Timing locking set
- PL Zestaw blokad rozrządu
- DE Nockenwellen-Arretierwerkzeugsatz
- RU Комплект блокировки газораспределения
- CZ Blokovací sada pro opravy rozvodů
- HU Vezérműrögztető szerszámkészlet
- RO Set blocare distribuție auto
- FR Jeu d'outils de calage de distribution
- IT Set di bloccaggio distribuzione auto
- ES Juego de bloques de distribución
- CN 引擎正时工具



6 PCS	1/2" 12.7mm
FOR VALVETRAIN DO UKŁADU ROZRZĄDU	FOR DIESEL ENGINES DO SILNIKÓW DIELA
	



 BMW: Serie 1 (E81, E82, E87, E88, F20), Serie 3 (E90, E91, E92, E93, F30), Serie 5 (E60, E61, F10, F11), X1 (E84), X3 (E83, F25)
 2.0 N47, N47S (2007-2010)

YATO 	
YT-06018	10

- EN Timing locking set
- PL Zestaw blokad rozrządu
- DE Nockenwellen-Arretierwerkzeugsatz
- RU Комплект блокировки газораспределения
- CZ Blokovací sada pro opravy rozvodů
- HU Vezérműrögztető szerszámkészlet
- RO Set blocare distribuție auto
- FR Jeu d'outils de calage de distribution
- IT Set di bloccaggio distribuzione auto
- ES Juego de bloques de distribución
- CN 引擎正时工具



7 PCS	FOR VALVETRAIN DO UKŁADU ROZRZĄDU
FOR GASOLINE ENGINES DO SILNIKÓW BENZYNOWYCH	



 Opel: Adam, Ampera, Astra J, Corsa D, Meriva B, Mokka, Zafira C Tourer; Chevrolet: Aveo
 1.0 A10 XEP, 1.2 A12 XEL, 1.2 A12 XER, 1.4 A14 XFL, 1.4 A14 XEL, 1.4 A14 XER, 1.4 A14 NEL, 1.4 A14 NET

YATO 	
YT-06009	5

- EN Timing locking set
- PL Zestaw blokad rozrządu
- DE Nockenwellen-Arretierwerkzeugsatz
- RU Комплект блокировки газораспределения
- CZ Blokovací sada pro opravy rozvodů
- HU Vezérműrögztető szerszámkészlet
- RO Set blocare distribuție auto
- FR Jeu d'outils de calage de distribution
- IT Set di bloccaggio distribuzione auto
- ES Juego de bloques de distribución
- CN 引擎正时工具



7 PCS	FOR VALVETRAIN DO UKŁADU ROZRZĄDU
FOR GASOLINE ENGINES DO SILNIKÓW BENZYNOWYCH	



 Opel: Astra G, H, Corsa D, Meriva (06-08), Vectra (06-08), Signum (06-08), Zafira (03-08); Chevrolet: Cruze, Orlando 1.4, 1.6, 1.8; Fiat: Croma; Alfa Romeo: 159
 Opel: 1.6-Z16LEL, Z16LER, Z16LET, Z16XE, Z16XER, 1.8-Z18XER; Chevrolet, Fiat, Alfa Romeo: 939A4.000

YATO 	
YT-06005	10

- EN Timing locking set
- PL Zestaw blokad rozrządu
- DE Nockenwellen-Arretierwerkzeugsatz
- RU Комплект блокировки газораспределения
- CZ Blokovací sada pro opravy rozvodů
- HU Vezérműrögztető szerszámkészlet
- RO Set blocare distribuție auto
- FR Jeu d'outils de calage de distribution
- IT Set di bloccaggio distribuzione auto
- ES Juego de bloques de distribución
- CN 引擎正时工具





7 PCS	FOR VALVETRAIN DO UKŁADU ROZRZĄDU
FOR GASOLINE ENGINES DO SILNIKÓW BENZYNOWYCH	

 Ford: B-Max (since 2010), C-Max (03-12), Fiesta (since 2013), Galaxy (since 2010), Focus (04-15), Grand C-Max (since 2010), Kuga (since 2013), Mondeo (since 2010), S-Max (since 2010), Tourneo Connect (since 2013), Transit Connect (since 2013); Volvo: S60 Cross Country T4 (11-15), S80 GTDi T3 (10-15), V40 GTDi T4 (12-15), V60 GTDi T4F (11-15), V70 T2/T3/T4 (10-15)
 HXJA, HXJB, HXDA, IQDA, IQDB, PNBA, RHBA, SIDA, 1.6Ti-VCT FFV, PNDA, JTWB, JTWA, JTDB, JTDA, JQDB, JQDA, IQJA, B4164T4, B4164T3, B4164T2, B4164T, JQMA, JQMB, JTMA, XTDA, MUDA, JTJA, JTBA, JTBB, KGBA, JQGA

YATO 	
YT-06029	5

EN Timing locking set
PL Zestaw blokad rozrządu
DE Nockenwellen-Arretierwerkzeugsatz
RU Комплект блокировки газораспределения
CZ Blokovači sada pro opravy rozvodů
HU Vezérműörgztű szerszámkészlet

RO Set blocare distribuție auto
FR Jeu d'outils de calage de distribution
IT Set di bloccaggio distribuzione auto
ES Juego de bloques de distribución
CN 引擎正时工具

 BMW: 2.0 d & 3.0 d: 118d E8 & 120d E87 (2003-2007), 318d/t E46/E90/E91 (2000-2008), 320d E46/E90/E91 (1997-2008), 320cd E46/E90/E91 (1997-2008), 325d E90/E91/E92/E93 (2006-2010), 330d E46/E90/E91/E92/E93 & 330cd E46/E90/E91/E92/E93 & 330cd E46/E90/E91/E92/E93 (1998-2008), 335d E90/E91/E92 (2006-2010), 520d E39/E60/E61 (1999-2010), 525d E39/E60/E61 (1999-2010), 525xd E39/E60/E61 (1999-2010), 530d E39/E60/E61 (1998-2010), 530xd (E39/E60/E61 (1998-2010), 535d E60/E61 (2004-2010), 635d E63/E64 (2004-2010), 730d E38/E65/E66 (1998-2008), X3 2.0d E83 (2003-2007), X3 3.0d E83 (2003-2010), X5 3.0d E53/E70 (2000-2010); Land Rover: Freelander 2.0 Td4 (2000-2006); Land Rover/Range Rover: 3.0 Td6 (2002-2006); Opel: Omega B (2001-2003)
 M47, M47TU, M47T2, M57, M57TU, M57TU2, Y25DT





7
PCS
FOR VALVETRAIN DO UKŁADU ROZRZĄDU
FOR DIESEL ENGINES DO SILNIKÓW DIESLA

YATO 
YT-06333  5

EN Timing locking set
PL Zestaw blokad rozrządu
DE Nockenwellen-Arretierwerkzeugsatz
RU Комплект блокировки газораспределения
CZ Blokovači sada pro opravy rozvodů
HU Vezérműörgztű szerszámkészlet

RO Set blocare distribuție auto
FR Jeu d'outils de calage de distribution
IT Set di bloccaggio distribuzione auto
ES Juego de bloques de distribución
CN 引擎正时工具

 Opel; Renault: Clio, Espace, Kangoo, Master, Megane, Safrane, Scenic, Spider, R5, R9, R11, R19, R21, R25, Trafic, Twingo
 Opel: DF7, E5F, E6J, E7F, E7J, K7M, F1N, F2N+R, F3N, F3P, F3R, J5R, J5T, J6R, J7R, J7T, DF4, F7P, F7R, F8M, F8Q, F9Q, J8S, G8T, S8U, S9U, S9W; Renault: 1.2, 1.4, 1.6, 1.7, 1.8, 2.0, 2.2, 1.2 16 V, 1.8 16 V, 2.0 16 V, 1.9 D, 1.9 TD, 1.9 dTi, 2.1 D, 2.1 Turbo, 2.2 D, 2.2 TD, 2.5 D, 2.5 TD, 2.8 D, 2.8 Turbo



7
PCS
FOR VALVETRAIN DO UKŁADU ROZRZĄDU
FOR DIESEL ENGINES DO SILNIKÓW DIESLA
FOR GASOLINE ENGINES DO SILNIKÓW BENZYNOWYCH

YATO 
YT-06325  10

EN Timing locking set
PL Zestaw blokad rozrządu
DE Nockenwellen-Arretierwerkzeugsatz
RU Комплект блокировки газораспределения
CZ Blokovači sada pro opravy rozvodů
HU Vezérműörgztű szerszámkészlet

RO Set blocare distribuție auto
FR Jeu d'outils de calage de distribution
IT Set di bloccaggio distribuzione auto
ES Juego de bloques de distribución
CN 引擎正时工具

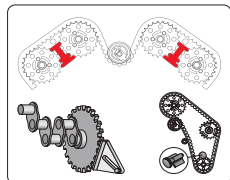

 Citroen: Berlingo, Dispatch, Relay, Synergie, Santia, Xsara, ZX; Fiat: Ducato, Ulysse; Ford; Isuzu; Opel: Astra, Calibra, Cavalier, Omega, Sintra, Vectra, Zafira; Peugeot: 205, 305, 306, 309, 406, 605, 806, Boxer, Expert, Partner 1.9 D, Talbot; Rover: 25, 45, 75, 200, 214, 216, 218, 414, 416, BRM; Saab: 900-9000; Volkswagen: Bora, Golf, Lupo, Polo, Passat
 Citroen: Berlingo 1.9 D, Dispatch 1.9 D/TD-FSO 1.9 D, Relay 1.9 D/TD, Synergie 1.9/2.0 T, Santia 1.9/2.0 D/TD/HDI, Xsara 1.9/2.0 D/HDI, ZX 1.9 D/TD, most diesels; Fiat: Ducato 2.0 D, Ulysse 1.8/2.0 Turbo; Ford: most diesels; Isuzu: 1.5/1.7 diesel engines; Opel: Astra G 1.4/1.6/1.8 16V (>1994), 1.7 TD, 2.0 16 V, Calibra 2.5/2.5/2.6 V6, Cavalier 2.5 V6, Omega B 2.5/2.6/3.0/3.2 V6, Sintra 3.0 V6, Vectra 1.6, 1.8/2.0 16V (>1995), A 2.5/2.6 V6, Zafira 1.6/1.8 16V; 1.6/1.7 diesel engines; 1.2/1.4/1.6/1.8/2.0 OHC petrol engines; Peugeot: 205 1.6/1.8/1.9 D, 305 1.6/1.8/1.9 D, 306 1.8/1.9 D/TD, 309 1.6/1.9 D-4.5 1.6/1.9D, 406 1.9 D, 605 2.0 D/TD, 806 1.9T D, Boxer 1.9/2.0 D/TD, Expert 1.9 D, Partner 1.9 D, Talbot (Express D, Horizon D-J5 D, Solara); Rover: 25 1.4/1.6/1.8/VVC, 45 1.4/1.6/1.8, 75 1.8, 200 Vi, 214 16V, 216 16V/Cabrio/ Coupe, 218 Coupe, 414 16V, 416 16V, BRM 1.8V; Volkswagen: Bora 1.9 TDI, Golf 1.9 TDI, Lupo 1.2/1.4/3.0 TDI, Polo 1.4 TDI, Passat 1.9 TDI





8
PCS
AI



YATO 
YT-0633  16

EN Timing locking set
PL Zestaw blokad rozrządu
DE Nockenwellen-Arretierwerkzeugsatz
RU Комплект блокировки газораспределения
HU Vezérműörgztű szerszámkészlet
RO Set blocare distribuție auto
FR Jeu d'outils de calage de distribution
IT Set di bloccaggio distribuzione auto
ES Juego de bloques de distribución
CN 引擎正时工具

RO Set blocare distribuție auto
FR Jeu d'outils de calage de distribution
IT Set di bloccaggio distribuzione auto
ES Juego de bloques de distribución
CN 引擎正时工具

 Ford: Galaxy 2.0, Focus 2.0, Mondeo, S-Max 2.0
 MGDA, TNBA, TNWA, TNWB, TPBA, TPWA, XQDA



8
PCS
FOR GASOLINE ENGINES DO SILNIKÓW BENZYNOWYCH

YATO 
YT-06026  5

- EN Timing locking set
- PL Zestaw blokad rozrządu
- DE Nockenwellen-Arretierwerkzeugsatz
- RU Комплект блокировки газораспределения
- CZ Blokovací sada pro opravy rozvodů
- HU Vezérműrögztítő szerszámkészlet
- RO Set blocare distribuție auto
- FR Jeu d'outils de calage de distribution
- IT Set di bloccaggio distribuzione auto
- ES Juego de bloques de distribución
- CN 引擎正时工具

 Ford: B-Max (12-15), C-Max (03-07), C-Max (07-10), C-Max (10-15), Fiesta (08-15), Focus (04-15), Galaxy (10-15), Grand C-Max (10-15), Kuga (13-15), Touneo Connect (13-15), Grand Touneo Connect (13-15), S-Max (10-15), Transit Connect (13-15); Mazda: 5 (CW) (10-15), 6 (GH) (10-13); Volvo: S60 (10-11); S80 (09-14), V40 Cross Country (10-14), V60 (10-14), V70 (09-14), XC60 (09-14)

 1.6: B4164T, B4164T2, B4164T3, HXDA, HXDB, HXJA, HXJB, IQDA, IQDB, IQJA, IQDA, JQDA, JQDB, JQGA, JQMA, JQMB, JTDA, JTDB, JTJA, JTMA, JTWB, MUDA, PNDA, RVJA, SIDA, U5JA, XTDA; 2.0: B4204T6, B4204T7, B4204T7 (MZRDIDS), MGDA, MZR2.0 (LF), R9DA, TNBA, TNBB, TNWA, TPBA, TPWA, ZQDA



8
PCS

FOR VALVETRAIN DO UKŁADU ROZRZĄDU

FOR GASOLINE ENGINES DO SILNIKÓW BENZYNOWYCH



YATO
YT-06028

5

- EN Timing locking set
- PL Zestaw blokad rozrządu
- DE Nockenwellen-Arretierwerkzeugsatz
- RU Комплект блокировки газораспределения
- CZ Blokovací sada pro opravy rozvodů
- HU Vezérműrögztítő szerszámkészlet
- RO Set blocare distribuție auto
- FR Jeu d'outils de calage de distribution
- IT Set di bloccaggio distribuzione auto
- ES Juego de bloques de distribución
- CN 引擎正时工具

 VAG: Audi: A3 (03-10); Seat: Altea, Ibiza, Leon; Skoda: Fabia II (07-09), Octavia (04-09), Roomster (06-09), Superb (09-10); VW: Eos (06-09), Golf (03-09), Golf Plus (05-09), Jetta (06-09), Passat (05-09), Polo (02-08), Scirocco (09-10), Tiguan (07-09), Touran (03-09)

 1.4 FSI: AXU, BKG, BLN; 1.4 TFSI: BLG, BMY, BWK, CAVA, CAVB, CAVC, CAVD, CAVF, CAXA, CAXC, CDGA; 1.6 FSI: BAG, BLF, BLP, BTS



8
PCS

+/-
0.01
mm

VAG

FOR VALVETRAIN DO UKŁADU ROZRZĄDU

FOR GASOLINE ENGINES DO SILNIKÓW BENZYNOWYCH



YATO
YT-06328

5

- EN Timing locking set
- PL Zestaw blokad rozrządu
- DE Nockenwellen-Arretierwerkzeugsatz
- RU Комплект блокировки газораспределения
- CZ Blokovací sada pro opravy rozvodů
- HU Vezérműrögztítő szerszámkészlet
- RO Set blocare distribuție auto
- FR Jeu d'outils de calage de distribution
- IT Set di bloccaggio distribuzione auto
- ES Juego de bloques de distribución
- CN 引擎正时工具

 Fiat: Ducato 1.9D / TD, Punto 1.7D / TD, Tempra 1.9TD, Tipo 1.9D

 149B1.000, 160A6.000, 160A7.000, 160D1.000, 176A3.000, 176A5.000, 176B3.000, 230A2.000, 230A3.000, 230A4.000, 280A1.000



8
PCS

FOR VALVETRAIN DO UKŁADU ROZRZĄDU

FOR DIESEL ENGINES DO SILNIKÓW DIELA



YATO
YT-06323

5

- EN Timing locking set
- PL Zestaw blokad rozrządu
- DE Nockenwellen-Arretierwerkzeugsatz
- RU Комплект блокировки газораспределения
- CZ Blokovací sada pro opravy rozvodů
- HU Vezérműrögztítő szerszámkészlet
- RO Set blocare distribuție auto
- FR Jeu d'outils de calage de distribution
- IT Set di bloccaggio distribuzione auto
- ES Juego de bloques de distribución
- CN 引擎正时工具

 BMW: 316i, 316i Compact, 318i, 320i, 323i, 325i, 328i, 330i, 518i, 520i, 523i, 525i, 528i, 728i, 730i

 M52TU, M54, M56, M40, M42, M43, M44, M50, M52



9
PCS

FOR VALVETRAIN DO UKŁADU ROZRZĄDU

FOR GASOLINE ENGINES DO SILNIKÓW BENZYNOWYCH



YATO
YT-06022

1

- EN Timing locking set
- PL Zestaw blokad rozrządu
- DE Nockenwellen-Arretierwerkzeugsatz
- RU Комплект блокировки газораспределения
- CZ Blokovací sada pro opravy rozvodů
- HU Vezérműrögítő szerszámkészlet
- RO Set blocare distribuție auto
- FR Jeu d'outils de calage de distribution
- IT Set di bloccaggio distribuzione auto
- ES Juego de bloques de distribución
- CN 引擎正时工具





9
PCS

FOR VALVETRAIN
DO UKŁADU
ROZRZĄDU

FOR GASOLINE
ENGINES
DO SILNIKÓW
BENZYNOWYCH



 Clio II, Megane / Scenic, Megane II, Scenic II, Laguna, Laguna II, Espace (since 1998)
 1.8 16 V F4P 720, 722, 760; 2.0 Turbo 16 V F4R 700, 701, 712, 713, 714, 715, 720, 722, 730, 732, 740, 741, 744, 746, 770, 771, 776, 780, 784, 786, 787, 790, 791, 792, 794, 795, 796, 797, 820, 830

YATO 
YT-06327

5

- EN Timing locking set
- PL Zestaw blokad rozrządu
- DE Nockenwellen-Arretierwerkzeugsatz
- RU Комплект блокировки газораспределения
- CZ Blokovací sada pro opravy rozvodů
- HU Vezérműrögítő szerszámkészlet
- RO Set blocare distribuție auto
- FR Jeu d'outils de calage de distribution
- IT Set di bloccaggio distribuzione auto
- ES Juego de bloques de distribución
- CN 引擎正时工具





9
PCS

FOR VALVETRAIN
DO UKŁADU
ROZRZĄDU

FOR GASOLINE
ENGINES
DO SILNIKÓW
BENZYNOWYCH



 Ford: Cougar, Fiesta/Courier, Focus/C-Max, Fusion, Galaxy, Mondeo, Puma, S-Max, Tourneo Connect, Transit Connect
 IQDA, IQDB, JQDA, JQDB, JQGA, IQJA, JQMA, JQMB, JTBA, JTBB, JTDA, JTDB, JTJA, JTMA, JTWA, JTWB, KGBA, MUDA, PNDA, XTDA

YATO 
YT-060261

10

- EN Timing locking set
- PL Zestaw blokad rozrządu
- DE Nockenwellen-Arretierwerkzeugsatz
- RU Комплект блокировки газораспределения
- CZ Blokovací sada pro opravy rozvodů
- HU Vezérműrögítő szerszámkészlet
- RO Set blocare distribuție auto
- FR Jeu d'outils de calage de distribution
- IT Set di bloccaggio distribuzione auto
- ES Juego de bloques de distribución
- CN 引擎正时工具





9
PCS

FOR VALVETRAIN
DO UKŁADU
ROZRZĄDU

FOR DIESEL
ENGINES
DO SILNIKÓW
DIELSA



 Nissan: Primastar (2006-), Qashqai (2007-); Renault: Espace/Grand Espace (2006-), Grand Scenic II (2006-), Koleos (2008-), Laguna II (2005-), Laguna III (2007-), Latitude (2010-), Megane II (2006-), Megane III (2009-), Scenic, Trafic (2008-), Vel Satis (2005-)
 Nissan: NV400 (2011-); 2.3 CDTi R9M, X-Trial (2007-); 2.0 DCi M9R; Opel: Movano B (2010-); 2.3 CDTi, Vivaro (2006-); 2.0 CDTi/ecoFlex; Renault: Grand Scenic III (2009-); 2.0DCi M9R, Master III (2010-); 2.3 DCi M9T

YATO 
YT-06010

5

EN Timing locking set
 PL Zestaw blokad rozrządu
 DE Nockenwellen-Arretierwerkzeugsatz
 RU Комплект блокировки газораспределения
 CZ Blokovačí sada pro opravy rozvodů
 HU Vezérműrögztítő szerszámkészlet
 RO Set blocare distribuție auto
 FR Jeu d'outils de calage de distribution
 IT Set di bloccaggio distribuzione auto
 ES Juego de bloques de distribución
 CN 引擎正时工具

Citroën: EP3C (8F01), EP6C (5F01), EP3 (8FS), EP6 (5FW), EP6DT (5FX), EP6CDT (5F04); Peugeot: EP3 (8FS), EP6 (5FW), EP6C (5F01), EP6DT (5FX), EP5DTS (5FY), EP3C (8F01), EP6DTX (5FU), EP6DTS (5FY), EP6CDT (5F04), EP6 (5FX), EP6CDTX (5FU); BMW Mini: N12 1.4 Valvetronic (1.4 VTI, 1.5 VTI), N14 1.6 Direktspritzer (1.6 THP); BMW: 1.4 VTI, 1.5 VTI, N14 (1.6 THP)

EN Timing locking set
 PL Zestaw blokad rozrządu
 DE Nockenwellen-Arretierwerkzeugsatz
 RU Комплект блокировки газораспределения
 CZ Blokovačí sada pro opravy rozvodů
 HU Vezérműrögztítő szerszámkészlet
 RO Set blocare distribuție auto
 FR Jeu d'outils de calage de distribution
 IT Set di bloccaggio distribuzione auto
 ES Juego de bloques de distribución
 CN 引擎正时工具

Audi: A1/A1 Sportback, A3 Cabrio, A3 Saloon, A3 Sedan, A3/A3 Sportback, A4, Allroad, A4 Quattro, A4/A5 Sportback, A5 Cabriolet, A5 Coupe, A6, TT, Q3, Q5; Seat: Alhambra, Ibiza, Leon, Leon ST; Skoda: Fabia III, Fabia III Estate, Rapid, Rapid Spaceback, Octavia III, Superb III; VW: Golf VI, Golf VII, Golf VII Estate, Golf VII SV/Sportsvan, Golf VII Wagon, Passat, Polo, Scirocco, Sharan II, Touran II, Tiguan

1.4: CUSA, CUSB, CUTA; 1.6: CLHA, CLHB, CRKA, CRKB, CXXA, CXXB; 2.0: CKFB, CKFC, CNHA, CNHC, CRBC, CRBD, CRFA, CRFC, CRLB, CRLC, CRMB, CRVA, CRVC, CSUA, CSUB, CSUD, CSUE, CUAA, CUNA, CUPA, CUUA, CUUB, CUWA, DDAA; OEM#: T10490, T10492, T10051, 3359, T10060A, T10264, T10265

EN Timing locking set
 PL Zestaw blokad rozrządu
 DE Nockenwellen-Arretierwerkzeugsatz
 RU Комплект блокировки газораспределения
 CZ Blokovačí sada pro opravy rozvodů
 HU Vezérműrögztítő szerszámkészlet
 RO Set blocare distribuție auto
 FR Jeu d'outils de calage de distribution
 IT Set di bloccaggio distribuzione auto
 ES Juego de bloques de distribución
 CN 引擎正时工具

Mercedes: A-Class (2012-2018), B-Class (2012-2019), C-Class (2009-2018), CLA Coupe (2013-2019), CLS (2011-2018), E-Class (2009-2016), GLA (2014-2020>), GLC (2015-2019), GLE (2015-2019), GLK (2008-2015), M-Class (2011-2015), S-Class (2010-2013), S-Class (2013-2017), SLC (2016-2017), SLK (2012-2016), Sprinter (2009-2020>), Vito/Viano (2010-2015), Vito/V-Class (2014-2020>)

M651: 1.8 (651.901), 2.1 (651.XXX), 2.2 (651.925), ENE (651.925)

EN Timing locking set
 PL Zestaw blokad rozrządu
 DE Nockenwellen-Arretierwerkzeugsatz
 RU Комплект блокировки газораспределения
 CZ Blokovačí sada pro opravy rozvodů
 HU Vezérműrögztítő szerszámkészlet
 RO Set blocare distribuție auto
 FR Jeu d'outils de calage de distribution
 IT Set di bloccaggio distribuzione auto
 ES Juego de bloques de distribución
 CN 引擎正时工具

Ford: 1.3 TDCi; Fiat: Punto 1.3 JTD Multi-Jet (2003-2007), Panda, Idea, Doblo: 1.3 JTD Multi (2003-2009); Suzuki: Ignis, Wagon, Swift: 1.3 CDTi (2003-2010); Opel: Corsa C, Combo C, Astra H, Tigra B, Meriva (2003-2009)
 188A9.000, 169A1.000, 188A8.000, 188A9.000, Z13DT, Z13DTJ



YATO
 YT-06001

10
 PCS

FOR VALVETRAIN
 DO UKŁADU
 ROZRZĄDU

FOR GASOLINE
 ENGINES
 DO SILNIKÓW
 BENZYNOWYCH



YATO
 YT-060175

10
 PCS

VAG

FOR VALVETRAIN
 DO UKŁADU
 ROZRZĄDU

FOR DIESEL
 ENGINES
 DO SILNIKÓW
 DIELSA



YATO
 YT-06322

11
 PCS

FOR MERCEDES
 DO
 MERCEDES

FOR VALVETRAIN
 DO UKŁADU
 ROZRZĄDU

FOR DIESEL
 ENGINES
 DO SILNIKÓW
 DIELSA



YATO
 YT-06003

12
 PCS

FOR VALVETRAIN
 DO UKŁADU
 ROZRZĄDU

FOR DIESEL
 ENGINES
 DO SILNIKÓW
 DIELSA

EN Timing locking set
PL Zestaw blokad rozrządu
DE Nockenwellen-Arretierwerkzeugsatz
RU Комплект блокировки газораспределения
CZ Blokovací sada pro opravy rozvodů
HU Vezérműrögztű szerszámkészlet
RO Set blocare distribuție auto
FR Jeu d'outils de calage de distribution
IT Set di bloccaggio distribuzione auto
ES Juego de bloques de distribución
CN 引擎正时工具

 Renault: Avantime (2005-2007), Clio (2001-2008), Espace (2000-2008), Kangoo (2000-2008), Laguna (1999-2001), Laguna II (2004-2007), Master (2000-2006), Megane (1999-2008), Modus (2004-2008), Scenic (1999-2008), Traffic (2001-2008), Twingo (2007-2008); Nissan: Almera N16 (2002-2006), Interstar (2002-2006), Kubistar (2003-2008), Micra K12 (2003-2008), Note (2006-2008), Primastar (2002-2007), Primera P12 (2003-2007), Qashqai (2008-2009); Opel: Movano (2000-2008), Vivaro (2001-2008)
 1.5 (K9K), 1.9 (F9Q), 2.2 (G9T), 2.5 (G9U)



12
PCS



FOR VALVETRAIN
DO UKŁADU
ROZRZĄDU

FOR DIESEL
ENGINES
DO SILNIKÓW
DIELSA



YATO 
YT-06006  8

EN Timing locking set
PL Zestaw blokad rozrządu
DE Nockenwellen-Arretierwerkzeugsatz
RU Комплект блокировки газораспределения
CZ Blokovací sada pro opravy rozvodů
HU Vezérműrögztű szerszámkészlet
RO Set blocare distribuție auto
FR Jeu d'outils de calage de distribution
IT Set di bloccaggio distribuzione auto
ES Juego de bloques de distribución
CN 引擎正时工具

 Ford: Fiesta, Puma, Focus (1998-2008), Focus C-Max, Escort, Orion, Mondeo (1998-2000), Cougar, Courier, Transit, Fusion, Sierra, Sierra, Tourneo (1983-2000), Connect; Mazda: 1.8D (199-1999), 121 (1995-2000), 2 (2002-2007), 3 (2003-), 5 (2005-), 6 (2002-), MX-5 (2005-), MPV (2002-2005), Tribute (2001-2004); Volvo: S40 (2004-2010), V50 (2004-2010), C30 (2006-2010)
 Diesel 1.8 D / TD, 1.8 Di, 1.8 TDCi, 2.5 Di / TD / TDCi / Turbo, 1.25 16 V, 1.4 16 V, 1.6 16 V, 1.8 16 V, 2.0 16 V, 2.3 16 V; C9DC, F9DA/B, FFDA, C9DA/B, BHDA/B, BHPA, HCPA, HCPB, P7PA, P9PA, R2PA, R3PA, RWPA, KKDA, G6DA, G6DB, G6DC, RTN, RTP, RTQ, RFK, RFN, RKD, RTJ, RTK, 4EB, 4EC, 4ED, 4FA, 4FB, 4FC, 4FD, 4GA, 4GB, 4GC, 4GD, 4GE, 4HB, 4HC, 4HA, FUJA, FUJB, FXJA, FXJB, FYJA, L8, LF, YF, L3



12
PCS

FOR VALVETRAIN
DO UKŁADU
ROZRZĄDU



FOR DIESEL
ENGINES
DO SILNIKÓW
DIELSA

FOR GASOLINE
ENGINES
DO SILNIKÓW
BENZYNOWYCH



YATO 
YT-06021  4

EN Timing locking set
PL Zestaw blokad rozrządu
DE Nockenwellen-Arretierwerkzeugsatz
RU Комплект блокировки газораспределения
CZ Blokovací sada pro opravy rozvodů
HU Vezérműrögztű szerszámkészlet
RO Set blocare distribuție auto
FR Jeu d'outils de calage de distribution
IT Set di bloccaggio distribuzione auto
ES Juego de bloques de distribución
CN 引擎正时工具

 Chevrolet: Captiva; Opel: Antara, Astra, Insignia; Saab: 9-5
 2.0: LHU/A20NFT, LTG/A20NHT, LDK/A20NHT; 2.4: LE5, LE9, A24XE, A24XF



14
PCS



FOR VALVETRAIN
DO UKŁADU
ROZRZĄDU

FOR GASOLINE
ENGINES
DO SILNIKÓW
BENZYNOWYCH



YATO 
YT-06027  5

EN Timing locking set
PL Zestaw blokad rozrządu
DE Nockenwellen-Arretierwerkzeugsatz
RU Комплект блокировки газораспределения
CZ Blokovací sada pro opravy rozvodů
HU Vezérműrögztű szerszámkészlet
RO Set blocare distribuție auto
FR Jeu d'outils de calage de distribution
IT Set di bloccaggio distribuzione auto
ES Juego de bloques de distribución
CN 引擎正时工具

 Audi: A3 (8P7), A4 (8K2/8K5), A5 (8T3), Q5, TT (8J3); Seat: Alhambra (710); Skoda: Octavia (1Z3/1Z5), Superb II; VW: Beetle (5C1/5C7), Jetta III+IV, Passat (3C5/CC)
 2006-2014 TSI, TFSI (1.8/2.0): CEAA, CGMA, CCZA, CCZB, CCZC, CCZD, CCUA, CAEB, BYJ, BYE, CDAA, CDAB, CDNC, CDZA, CADA, CP5A



16
PCS

VAG

FOR VALVETRAIN
DO UKŁADU
ROZRZĄDU

FOR GASOLINE
ENGINES
DO SILNIKÓW
BENZYNOWYCH





YATO 
YT-06024  5

- EN Timing locking set
- PL Zestaw blokad rozrządu
- DE Nockenwellen-Arretierwerkzeugsatz
- RU Комплект блокировки газораспределения
- CZ Blokovací sada pro opravy rozvodů
- HU Vezérműrögztítő szerszámkészlet
- RO Set blocare distribuție auto
- FR Jeu d'outils de calage de distribution
- IT Set di bloccaggio distribuzione auto
- ES Juego de bloques de distribución
- CN 引擎正时工具

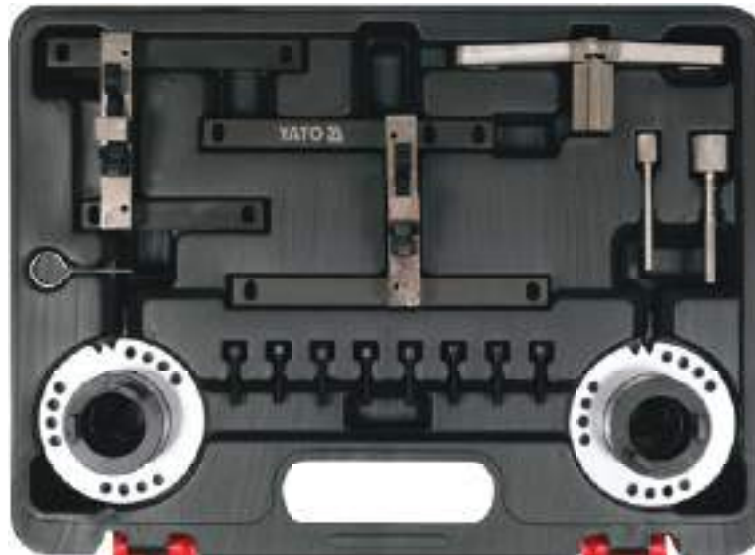
16 PCS	FOR VALVETRAIN DO UKŁADU ROZRZĄDU
FOR GASOLINE ENGINES DO SILNIKÓW BENZYNOWYCH	



 Ford: B-Max, C-Max, EcoSport, Fiesta, Focus, Grand C-Max, Tourneo Connect, Transit Courier, Transit Connect
 1.0 EcoBoost: M1DA, M1JA, M2DA, M2GA, P4JA, P4JB, SFJA, SFJB, XMJA, XMJB

YATO 	
YT-060262	2

- EN Timing locking set
- PL Zestaw blokad rozrządu
- DE Nockenwellen-Arretierwerkzeugsatz
- RU Комплект блокировки газораспределения
- CZ Blokovací sada pro opravy rozvodů
- HU Vezérműrögztítő szerszámkészlet
- RO Set blocare distribuție auto
- FR Jeu d'outils de calage de distribution
- IT Set di bloccaggio distribuzione auto
- ES Juego de bloques de distribución
- CN 引擎正时工具

17 PCS	FOR VALVETRAIN DO UKŁADU ROZRZĄDU
FOR DIESEL ENGINES DO SILNIKÓW DIEŚLA	FOR GASOLINE ENGINES DO SILNIKÓW BENZYNOWYCH
	





 Renault: Clio 1.2/1.4, 1.4/1.6/1.8 16V, Clio Sport 2.0 16V R19 1.4, Clio Williams 2.0 16V R19 1.4 Eco, Espace 2.0 R19 1.8 16V, 2.0 16V, 2.2 TD, Express 1.4, Extra 1.4, Kangoo 1.2/1.4, Laguna 1.6 16V, 1.8/2.0, 1.8/2.0 16V, 2.2 D/TD, 2.5 D/TD, Megane 1.4/1.6/2.0 16V, 2.5D/TD, Rapid 1.4, Safrane 2.0 16V, 2.2 TD, 2.5 20V, Scenic 1.4/1.6/2.0 16V, Trafic 2.5D, Twingo 1.2

YATO 	
YT-06324	4

- EN Timing locking set
- PL Zestaw blokad rozrządu
- DE Nockenwellen-Arretierwerkzeugsatz
- RU Комплект блокировки газораспределения
- CZ Blokovací sada pro opravy rozvodů
- HU Vezérműrögztítő szerszámkészlet
- RO Set blocare distribuție auto
- FR Jeu d'outils de calage de distribution
- IT Set di bloccaggio distribuzione auto
- ES Juego de bloques de distribución
- CN 引擎正时工具

29 PCS	FOR VALVETRAIN DO UKŁADU ROZRZĄDU
FOR DIESEL ENGINES DO SILNIKÓW DIEŚLA	FOR GASOLINE ENGINES DO SILNIKÓW BENZYNOWYCH
	



 Opel: Agila, Combo C, Corsa, Frontiera, Omega, Sintra, Tigra, Vectra, Zafira
 1.3 CDTI 16V, 1.9 CDTI, 2.0 DTI, 2.2 DTI, 1.0 DTI, 1.0 IZU, 1.2 16V (since 1996); 1.4 16V, 1.6 16V, 1.8 16V, 2.0 16V, 2.2 16V (since 1995)

YATO 	
YT-06007	2

- EN Timing locking set
- PL Zestaw blokad rozrządu
- DE Nockenwellen-Arretierwerkzeugsatz
- RU Комплект блокировки газораспределения
- CZ Blokovací sada pro opravy rozvodů
- HU Vezérműrögztűlő szerszámkészlet
- RO Set blocare distribuție auto
- FR Jeu d'outils de calage de distribution
- IT Set di bloccaggio distribuzione auto
- ES Juego de bloques de distribución
- CN 引擎正时工具



34
PCS

VAG 

YATO  
YT-06015 4

- EN Injector seat cleaning brush set
- PL Zestaw szczotek do gniazd wtryskiwaczy
- DE Injektorsitz Bürsten
- RU Ерши для чистки гнезд свечей зажигания и форсунок
- CZ Sada kartáčků na čištění sedel vstřikovačů
- HU Befekskendőző fészek tisztító készlet
- RO Perii cilindrice pt. curatarea gaurilor
- FR Brosses pour puits d'injecteurs
- IT Set di spazzole per la pulizia della sede dell'iniettore
- ES Juego de cepillos para limpieza de inyectores
- CN 钢丝刷



20
PCS



150
mm

1/4"
6.3mm

SS
STAINLESS STEEL
STAL. NIERZĘDZONA

BRASS
MOSIADZ

NYLON 

YATO  
YT-08195 20

Ø 9, 11, 13, 15, 17, 19 mm

- EN Injector seat cleaning brush set
- PL Zestaw szczotek do gniazd wtryskiwaczy
- DE Injektorsitz Bürsten
- RU Ерши для чистки гнезд свечей зажигания и форсунок
- CZ Sada kartáčků na čištění sedel vstřikovačů
- HU Befekskendőző fészek tisztító készlet
- RO Perii cilindrice pt. curatarea gaurilor
- FR Brosses pour puits d'injecteurs
- IT Set di spazzole per la pulizia della sede dell'iniettore
- ES Juego de cepillos para limpieza de inyectores
- CN 钢丝刷组套



38
PCS



150
mm

1/4"
6.3mm

SS
STAINLESS STEEL
STAL. NIERZĘDZONA

BRASS
MOSIADZ

NYLON 

YATO  
YT-08196 10

Ø 8, 9, 10, 11, 12, 13, 14, 15, 16, 17, 18, 19 mm

- EN Diesel injector puller
- PL Ściągacz bezwładnościowy do wtryskiwaczy
- DE Stoßabziehvorrichtung für Einspritzdüse
- RU Ударный съемник форсунок
- CZ Rázový vytahovač vstřikovačů
- HU Diesel porlasztó kisedő
- RO Dispozitiv de scos injectoare
- FR Extracteur à choc d'injecteurs
- IT Martello scorrevole per la rimozione degli iniettori
- ES Tuerca tensora de impacto para inyectores
- CN 柴油喷嘴拔取器



M8

M12

M14

BOSCH
TYPE

LUCAS
TYPE 

YATO  
YT-0617 20

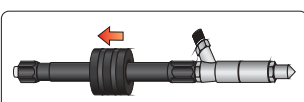

- EN Injector puller
- PL Zestaw do demontażu wtryskiwaczy
- DE Set zum Abmोलieren von Einspritzdüsen
- RU Комплект для снятия форсунок
- CZ Souprava pro demontáž vstřikovačů
- HU Befecskendező készlet
- RO Extractor injectoare
- FR Ensemble pour démonter les injecteur
- IT Kit per estrazione iniettori
- ES Kit de desmontaje de inyectoros
- CN 雪铁龙-标致柴油嘴拆卸工具

10 PCS HDI BOSCH SIEMENS



- EN Injector puller set CDI
- PL Ściągacz do wtrysków CDI
- DE Diesel-Injektoren-Auszieher-Satz CDI
- RU Съёмник дизельных форсунок CDI
- CZ Vytahovač vstřikovačů s úderovým kládívem CDIú
- HU Porlasztó kihúzó készlet csúszó kalapáccsal CDI motorhoz
- RO Set extractor pt. injectoare cu ciocan inertial pt. motoare CDI
- FR Coffret extracteur d'injecteur diesel CDI
- IT Estrattore iniettori per Mercedes CDI
- ES Juego 8 piezas de extracción de inyectoros en CDI
- CN 柴油喷嘴拆卸工具

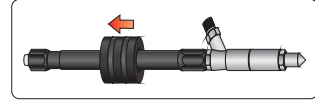

8 PCS



Mercedes: CDI OM611, OM612, OM613

YATO YT-05338 4

YATO YT-06176 5

- EN Diesel injector master removal set
- PL Zestaw ściągaczy bezwładnościowych do wtryskiwaczy
- DE Injektor Auszieher Abzieher Werkzeug Einspritzdüsen
- RU Съёмник форсунок с ударным молотком для дизельных двигателей
- CZ Souprava na demontáž vstřikovačů s reverzním kládívem
- HU Injektor kihúzó készlet, csúszókalapáccsal
- RO Set de extractoare inertiiale pt. injectoare
- FR Coffret extracteur d'injecteur
- IT Set di estrattori ad ineria per iniettori
- ES Extractor de inyectoros de inyección
- CN 柴油喷嘴维修工具



14 PCS 1/2" 12.7mm

YATO YT-06174 2

- EN Diesel injector master removal kit
- PL Zestaw ściągaczy bezwładnościowych do wtryskiwaczy
- DE Injektor Auszieher Abzieher Werkzeug Einspritzdüsen
- RU Съёмник форсунок с ударным молотком для дизельных двигателей
- CZ Souprava na demontáž vstřikovačů s reverzním kládívem
- HU Injektor kihúzó készlet, csúszókalapáccsal
- RO Set de extractoare inertiiale pt. injectoare
- FR Coffret extracteur d'injecteur
- IT Set di estrattori ad ineria per iniettori
- ES Extractor de inyectoros de inyección
- CN 柴油喷嘴维修工具

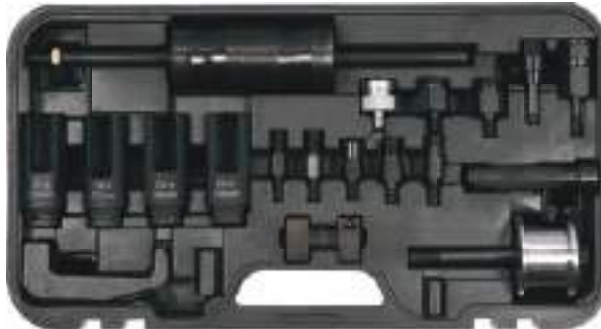

22 PCS 1/2" 12.7mm PUMP DUSE DIESEL INJECTORS POMPŪ WTRYSKIWACZY 2 HAMMERS BELCITY

YATO YT-06175 1

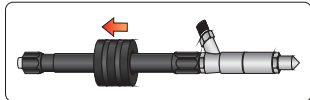

- EN Injector seat cleaning set
- PL Zestaw do czyszczenia gniazd wtryskiwaczy
- DE Einspritzdüsen-Reinigungsset
- RU Набор для чистки инжектора
- CZ Sada na čištění dosedacích sedel vstřikovačů
- HU Befecskendező fészek tisztító készlet
- RO Set de curățare scaun injector
- FR Kit de nettoyage pour injecteurs
- IT Kit per pulizia sedi iniettori
- ES Juego de limpieza para asientos de inyectoros
- CN 喷油器插座清洁组套



19 PCS 1/4" 6.3mm SS NYLON BRASS MOSIĄDZ

YATO YT-17623 10

Brass: Ø 17, 20, 23 mm; Nylon: Ø 16, 17, 18 mm; Steel: Ø 7 mm
Mosiądz: Ø 17, 20, 23 mm; Nylon: Ø 16, 17, 18 mm; Stal: Ø 7 mm

EN Injector seat cleaning set
PL Zestaw do czyszczenia gniazd wtryskiwaczy
DE Einspritzdüsen-Reinigungsset
RU Набор для чистки инжектора
CZ Sada na čištění dosedacích sedel vstřikovačů
HU Befecskendező fészék tisztító készlet
RO Set de curățare scaun injector
FR Kit de nettoyage pour injecteurs
IT Kit per pulizia sedi iniettori
ES Juego de limpieza para asientos de inyectoros
CN 清洁刷套装

23
PCS

10
mm

20
mm

BRASS
MOSIADZ





YATO 
YT-17622

 25

EN Injector seat and manhole cleaning set
PL Zestaw do obsługi gniazd wtryskiwaczy
DE Wartungssatz für Einspritzdüsen
RU Набор для обслуживания патрубков форсунок
CZ Sada pro údržbu hlízd vstřikovače
HU Befecskendező-aljzat szerelőkészlet
RO Set curățare scaun injector și gura de vizitare
FR Kit de montage et démontage d'injecteurs
IT Set per pulizia sedi iniettori
ES Juego para casquillos de inyectoros
CN 喷油嘴底座清理工具

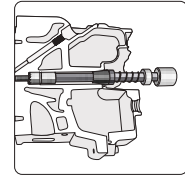
21
PCS



 17x17 mm, 17x19 mm;
 120° 17x17 mm

YATO 
YT-17627

 4

EN Diesel injector copper washer remover install tool
PL Przystaw do wyciągania podkładek wtryskiwaczy
DE Ausziehvorrichtung für Einspritzdüsenunterlagen
RU Инструмент для снятия шайб форсунок
CZ Nástroj pro demontáž podložek vstřikovačů
HU Befecskendező alátét eltávolító szerszám
RO Instrument instalare / extragare injector diesel
FR Extracteur d'injecteur diesel
IT Estrattore per rondelle iniettori
ES Herramienta para quitar arandelas de inyectoros
CN 柴油喷油嘴垫片拆卸器

7.5-10
mm

260
mm



YATO 
YT-17629

 10

EN Glow plug reamer set
PL Zestaw do czyszczenia gniazd świec żarowych
DE Reinigungssset für Glühkerzen
RU Набор для чистки свечей накаливания
CZ Sada k čištění otvorů zážehových svíček
HU Gyújtógyertya aljzat tisztítókészlet
RO Set de curățat și rectificat filete pt. bujii incandescente
FR Kit de nettoyage des puits de bougie de préchauffage
IT Kit per pulizia delle bussole delle candele
ES Set de limpieza de asientos de bujías incandescentes
CN 热塞铰刀组套

3
PCS

M10x1.0
M12x1.25
M12x1.25

CrV



M10 x 1 mm; M12 x 1.25 mm; M12 x 1.25 mm

YATO 
YT-05341

 10/20

EN Glow plug reamer set
PL Zestaw do czyszczenia gniazd świec żarowych
DE Reinigungsset für Glühkerzen
RU Набор для чистки свечей накаливания
CZ Sada k čištění otvorů zážehových svíček
HU Gyújtógyertya aljzat tisztítókészlet
RO Set de curățat și rectificat filete pt. bujii incandescente
FR Kit de nettoyage des puits de bougie de préchauffage
IT Kit per pulizia delle bussole delle candele
ES Set de limpieza de asientos de bujías incandescentes
CN 预热塞螺纹修复组套

10
PCS

M8
x1.0

M10
x1.0

M10
x1.25

M12
x1.25

S45C



YATO 
YT-17712

 10

EN Glow plug puller set
PL Zestaw do demontażu uszkodzonej świecy żarowej
DE Demontagesatz für beschädigte Glühkerzen
RU Набор для снятия поврежденных свечей накаливания
CZ Sada pro demontáž poškozené žhavicí svíčky
HU Izzítógyertya kiszerező készlet
RO Set extractor bujii incandescente
FR Kit de démontage d'une bougie de préchauffage défectueuse
IT Set per rimozione candele danneggiate
ES Juego de desmontaje de la bujía dañada
CN 预热塞拆卸器

7
PCS

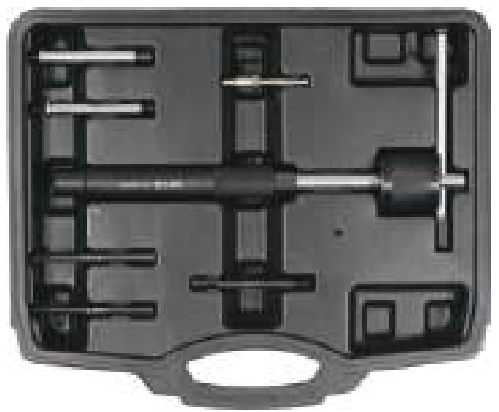
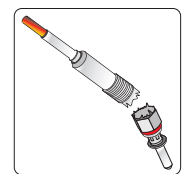

YATO 
YT-05343

 5

EN Broken glow plug removal set
 PL Zestaw do demontażu urwaných świec żarowych
 DE Glühkerzen-Demontage-Werkzeug-Satz
 RU Набор инструментов для демонтажа свечей накаливания
 CZ Přípravek pro odvrtání a opravu závitu žhavicích svíček
 HU Törött izzítógyertya-eltávolító készlet
 RO Set extractoare pt. bujii rupte
 FR Kit extracteur bougie de préchauffage
 IT Kit per l'estrazione delle candele rotte
 ES Kit de extractor de bujías incandescentes
 CN 预热塞修理工具

16 PCS **3/8"** 9,5 mm **HSS 4241** **CrV**

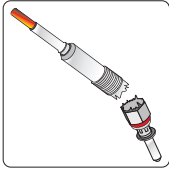

YATO **YT-05342** 5

EN Glow plug heater element removal set
 PL Zestaw do demontażu żarnika świec
 DE Set zur Glühfaden-Demontage
 RU Комплект для снятия свечей накаливания
 CZ Souprava pro odstranění vlákná svíc
 HU Gyújtógyertya kiszedő készlet
 RO Extractor element incalzitor buji
 FR Kit extracteur de filament de bougie
 IT Kit per l'estrazione dei filamenti delle candele
 ES Kit de desmontaje de filamento de vela
 CN 预热塞

22 PCS **HSS**



M8 x 1 mm; M10 x 1 mm; M10 x 1.25 mm

YATO **YT-05345** 10

EN Valve grinding set
 PL Zestaw docieraków ręcznych do zaworów
 DE Handventil-Läppsatz
 RU Набор для ручной притирки клапанов
 CZ Sada přípravků pro lapování ventilů
 HU Manuális szelepcsizoló készlet
 RO Set pt. slefuit supape
 FR Kit de rodage soupape
 IT Kit di utensili manuali per lappatura valvole
 ES Conjunto de reguladores manuales de válvulas
 CN 气门研磨棒



2 PCS **15-20** mm **30-36** mm

YATO **YT-06187** 40

EN Overhead valve spring compressor
 PL Przyrząd do demontażu zaworów silnikowych
 DE Vorrichtung zur Demontage von Motorventilen
 RU Устройство для демонтажа клапанов двигателя
 CZ Přípravek na demontáž ventilů motoru
 HU Szeleplehúzó készülék
 RO Dispozitiv pt. demontarea supapelor la motoare
 FR Outil pour démonter les soupapes de moteur
 IT Strumento per la rimozione di valvole motore
 ES Instrumento para desmontaje de válvulas de motor
 CN 下压式凡尔钳

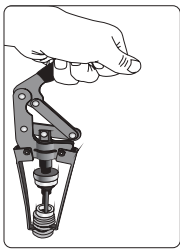

YATO **YT-0618** 5/25

EN Overhead valve spring compressor
 PL Przyrząd do demontażu zaworów silnikowych
 DE Vorrichtung zur Demontage von Motorventilen
 RU Устройство для демонтажа клапанов двигателя
 CZ Přípravek na demontáž ventilů motoru
 HU Szeleplehúzó készülék
 RO Dispozitiv pt. demontarea supapelor la motoare
 FR Outil pour démonter les soupapes de moteur
 IT Strumento per la rimozione di valvole motore
 ES Instrumento para desmontaje de válvulas de motor
 CN 气门弹簧压缩器

320 mm **OHV** **FOR ENGINE VALVES DO ZAWORÓW SILNIKOWYCH**



YATO **YT-06184** 10/20

EN Exhaust pipe expander set
 PL Zestaw rozpierek do rur wydechowych
 DE Auspuffrohr-Aufweitungs-Satz
 RU Комплект распорок для выхлопных труб
 CZ Sada expanďerů do výfuků
 HU Kipufogócső tágitó készlet

RO Set largire teava esapament
 FR Kit élargisseur de tuyau d'échappement
 IT Kit di cilindri per tubi di scarico
 ES Kit expansor para tubos de escape
 CN 排气管扩孔器

3 PCS **17** mm **19** mm **29-42** mm **38-62** mm **54-89** mm



YATO **YT-06166** 5

EN Exhaust pipe cutting tool
 PL Obcinak do rur wydechowych
 DE Auspuffrohrschneider
 RU Цепной резак выхлопной трубы
 CZ Rezačka výfukového potrubí
 HU Kipufogócső vágó
 RO Instrument de tăiere a țevilor de esapament
 FR Coupeur de tuyau d'échappement
 IT Tagliatubi di scarico
 ES Cortador de tubos de escape
 CN 排气管割刀

max 2.5mm **18-95** mm **x15** **GCr15**



YATO **YT-06169** 12/24

EN Oxygen sensor crowfoot wrench
PL Klucz do sondy lambda
DE Schlüssel für die Lambdasonde
RU Ключ для зонда лямбда

CZ Klíč na sondu lambda
HU Lambda szonda kulcs
RO Cheie pt. sonda lambda
FR Clé pour sonde lambda

IT Chiave per sonde lambda
ES Llave para la sonda lambda
CN 氧传感器套筒扳手

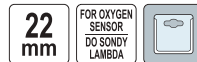

CrMo
SCM440

CrV
50BV30

YATO	
YT-1753	15/60

YATO	
YT-1754	6/36

EN Socket and oxygen sensor set
PL Klucze nasadowe do sondy lambda
DE Steckschlüssel für Lambdasonde
RU Торцовые ключи с внутренним многогранником для зонда лямбда
CZ Nástrčné klíče na sondy lambda
HU Dugókulcs lambda szondához
RO Prize pt. sonda slambda
FR Douille pour sonde lambda
IT Set di riparazione per filetti di sonde lambda
ES Llaves de cubo para la sonda lambda
CN 氧传感器套筒扳手组套

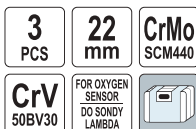

EN Oxygen sensor extra-long socket
PL Klucz do sondy lambda extra dlugi
DE Lambdasonde-Schlüssel extra lang
RU Ключ для лямбда-зонда удлиненный
CZ Klíč do lambda sondy extra dlouhý
HU Lambdaszonda kulcs extra hosszú
RO Cheie lunga pt. senzorul de oxigen
FR Clé pour sonde lambda extra longue
IT Chiave extra lunga per sonda lambda
ES Llave para sonda lambda extra larga
CN 加长含氧感应套筒

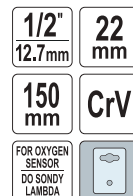

22 mm; L= 50 mm; 6PT; CrMo SCM440;
 22 mm; L=30 mm; 6PT; CrMo SCM440;
 22 mm; L=80 mm; 6PT; CrV 50BV30

YATO	
YT-1752	20

YATO		L [mm]	
YT-17513	1/2" (12.7 mm)	150	10/60

EN Oxygen flexi head wrench
PL Klucz lamany do sondy lambda
DE Gelenkschlüssel für Lambdasonde
RU Двусторонний ключ для лямбда-зонда
CZ Lámaný klíč do lambda sondy
HU Lambda szonda kulcs
RO Cheie articulata pt. conducte oxigen
FR Clé articulée pour sonde lambda
IT Chiave pieghevole per sonda lambda
ES Llave articulada para la sonda lambda
CN 氧传感扳手

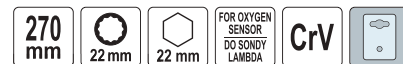

YATO	
YT-17515	6/36

EN Oxygen sensor and fuel injectors wrench set
PL Zestaw nasadek do sondy lambda i wtryskiwaczy
DE Steckschlüsselsatz für Lambdasonde und Einspritzdüsen
RU Набор насадок к лямбда-зондам и форсункам
CZ Sada nástavců na demontáž sondy lambda a vstříkovačů
HU Dugókészlet lambda szondákhoz és injektorokhoz
RO Set inelare pt. sonda lambda și injectoare
FR Douilles pour sonde lambda et injecteurs
IT Set di attrezzi per sonda lambda e iniettore
ES Juego de boquillas para la sonda lambda y para inyectores
CN 氧传感器套筒扳手组套

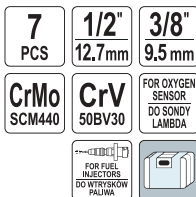

EN Oxygen sensor socket & thread chaser set
PL Zestaw do obsługi sondy lambda
DE Wartungssatz für Lambdasonde
RU Набор для обслуживания лямбда-зонда
CZ Sada pro práci s lambda sondou
HU Lambdaszonda szerelő szerszám
RO Set cheie senzor oxigen
FR Kit de douilles pour sonde lambda
IT Strumento per la rimozione della sonda Lambda
ES Juego de vaso para sonda lambda
CN 氧传感器套筒

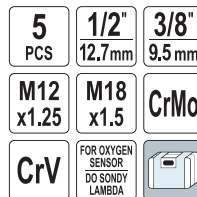

1/2" (12.7 mm) x 29 mm; L=90 mm; 6PT;
 3/8" (9.5 mm) x 22 mm; L=90 mm; 6PT;
 1/2" (12.7 mm) x 27 mm; L=78 mm; 12PT;
 3/8" (9.5 mm) x 27 mm; L=74 mm; 6PT;
 3/8" (9.5 mm) x 22 mm; L=80 mm; 6PT;
 1/2" (12.7 mm) x 22 mm; L=50 mm; 6PT;
 3/8" (9.5 mm) x 22 mm; L=30 mm; 6PT

22 mm; L=50 mm; 6PT; CrMo;
 22 mm; L=30 mm; 6PT; CrMo;
 22 mm; L=80 mm; 6PT; CrV

YATO	
YT-1751	1/2" (12.7 mm), 3/8" (9.5 mm) 5

YATO	
YT-17510	1/2" (12.7 mm), 3/8" (9.5 mm) 20

- EN Slotted special socket set
- PL Zestaw nasadek otwartych
- DE Spezial-Steckschlüssel-Einsätze, geschlitzt
- RU Набор головок разрезных
- CZ Sada otevřených hlavíc
- HU Crowfafej speciális végig nyitott
- RO Set de chei tubulare pt. injectoare
- FR Ensemble de clés creuses avec fenêtré latérale
- IT Set di attacchi aperti
- ES Conjunto de teclas huecas con ventana lateral
- CN 开槽油管扳手

7 PCS 3/8" 9.5 mm 1/2" 12.7 mm CrV



10, 11, 12, 13, 14, 17, 19 mm

YATO **YT-17508** 6/24

- EN Flexible crowfoot socket wrench set
- PL Zestaw kluczy przegubowych oczkowych otwartych
- DE Gelenk-Ringschlüssel-Satz (offen)
- RU Набор ключей разрезных с шарниром
- CZ Sada otevřených očkových kloubových klíčů
- HU Nyitott csőkulcs készlet
- RO Set chei tubulare articulate
- FR Set de clés à tête fendue articulée
- IT Set di chiavi snodate ad anello aperte
- ES Juego de llaves articuladas de anillo abiertas
- CN 万向扳手

6 PCS 3/8" 9.5 mm 12-19 mm HRC 43-47 CrV 40Cr



3/8" (9.5 mm): 12, 14, 16, 17, 18, 19 mm; 40Cr/CrV

YATO **YT-01440** 3/8" (9.5 mm) 10

- EN Flexible crowfoot socket wrench set
- PL Zestaw kluczy przegubowych oczkowych otwartych
- DE Gelenk-Ringschlüssel-Satz (offen)
- RU Набор ключей разрезных с шарниром
- CZ Sada otevřených očkových kloubových klíčů
- HU Nyitott csőkulcs készlet
- RO Set chei tubulare articulate
- FR Jeu de clés à tête fendue articulée
- IT Set di chiavi snodate ad anello aperte
- ES Juego de llaves articuladas de anillo abiertas
- CN 万向扳手

12 PCS 3/8" 9.5 mm 8-19 mm HRC 42-48 CrV



3/8" (9.5 mm): 8, 9, 10, 11, 12, 13, 14, 15, 16, 17, 18, 19 mm; CrV

YATO **YT-38550** 3/8" (9.5 mm) 10

- EN Diesel injection socket set
- PL Zestaw nasadek do wtrysków w silnikach Diesla
- DE Aufsätze für Einspritzungen bei Dieselmotoren
- RU Набор насадок к форсункам в дизельных двигателях
- CZ Sada nástavců na trysky dieselových motorů
- HU Szerszámkészlet Dieselmotor befecskendezőkhöz
- RO Set de capete pt. injectoare în motoare Diesel
- FR Set des douilles pour injecteurs (diesel)
- IT Set di custodie per i motori diesel
- ES Juego de tapones para las inyecciones en los motores de Diesel
- CN 柴油机加注套筒组套

6 PCS 1/2" 12.7 mm CrV AS-DRIVE



21x90; 22x78; 22x110; 27x78; 28x78; 28x83 mm

YATO **YT-0622** 1/2" (12.7 mm) 10

- EN Diesel injector and cutter set
- PL Zestaw frezów do gniazd wtryskiwaczy Common Rail
- DE Fräasersatz für Buchsen der Einspritzdüsen
- RU Комплект фрез для гнезд сопел форсунок
- CZ Sada fréz na sedla trysek vstříkovačů
- HU Marókészlet befecskendező fűvókájának fészkéhez
- RO Set de freze pt. socluri de duze injectoare
- FR Alimentation d'un injecteur de Common Rail
- IT Set di frese per sedi iniettori Common Rail
- ES Juego de fresas para el asiento de toberas de inyectores
- CN 气门铰刀

7 PCS CrMoV SKD11

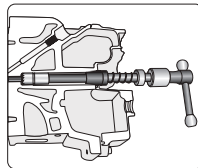

17x17 mm, 17x19 mm, 15x19 mm; CrMoV SKD11;
120° 17x17 mm, 120° 17x21 mm; CrMoV SKD11

YATO **YT-17625** 10

- EN Tooth socket for injection nozzle
- PL Zestaw kluczy czopowych do wtryskiwaczy w samochodach ciężarowych
- DE Stiftschlüsselsatz für Einspritzdüse in Lastkraftwagen
- RU Набор шиповых ключей к форсункам грузовых автомобилей
- CZ Sada klíčů na vstříkovače pro nákladní automobily
- HU Csaposkulcs készlet tehergépkocsik befecskendezőjéhez
- RO Set chei tubulare cu ungere pt. camioane
- FR Set de douilles injecteurs
- IT Set di chiavi per iniettori camion
- ES Juego de llaves de muñón para los inyectores en camiones
- CN 卡车喷油嘴套筒组套

4 PCS 1/2" 12.7 mm CrMo S45C CrV



1/2" (12.7 mm); L=72 mm; 4T; CrV;
32 mm; M14 x 1.5 mm; L=70 mm, 4T; S45C;
1/2" (12.7 mm); L=120 mm; 3T; CrMo;
32 mm; L=120 mm, 4T; S45C

YATO **YT-1762** 1/2" (12.7 mm) 8

EN Socket key-attachments for Bosch VE-pumps
PL Zestaw nasadek do pomp wtryskowych Bosch VE
DE Aufsatz-Set für Bosch VE Einspritzpumpen
RU Набор насадок для инжекторных насосов Bosch VE
CZ Sada násad pro vstřikovací čerpadla Bosch VE
HU Dugókulcs készlet Bosch VE befecskendőző szivattyúhoz
RO Set tubulare speciale pt. pompe injectie Bosch
FR Jeu de douilles Bosch VE pour pompes d'injection
IT Kit di attacchi per pompe d'iniezione Bosch VE
ES Set de accesorios para bombas de inyección Bosch VE
CN 博世泵套筒

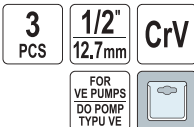

YATO
YT-17525 1/2" (12.7 mm) 12/48

EN Camshaft adapter socket set
PL Zestaw nasadek do regulacji faz rozrządu
DE Nockenwellen-Adapter-Steckschlüssel-Satz
RU Набор для регулировки распределительного вала
CZ Přípravky na nastavení fází časování rozvodu
HU Vezérműtengely állító dugókulcs készlet
RO Set chei adaptatoare arbore cu came
FR Jeu d'adaptateurs d'arbre à cames
IT Set di bussolle per sincronizzatore albero a camme
ES Vasos para girar el árbol de levas
CN 凸轮轴接头套筒

Audi: A3 (2011-, 2005-2013), A3 Quattro (2009-2013), A4 (2008, 2009-2015, 2016-), A4 Quattro (2009-2015), A5 (2008-2011), A5 Cabriolet (2009), A5 Coupe (2008), A5 Quattro (2009-2016), A6 2.0 TFSI (2012-2014), Tiguan (2016-), Q3 (2012-2015), Q5 (2008, 2009-2016), TT (2010-2014), TT Quattro (2009-2014); Seat: Alhambra (2011), Altea (2011), Altea XL (2009), Exeo (2009), Freerack (2011), Leon (2011); Skoda: Octavia (2009-2013), Superb (2009-2015), Yeti 1.8 TSI (2010-2015); VW: Beetle 2.0 TSI (2012-2016), CC 1.8 TSI/2.0 TSI (2012-2016), EOS 2.0 TSI (2010-2016), Golf GTI 1.8 TSI/2.0 TSI (2009-2013), Jetta GLI 2.0 TSI (2008-2014), Passat 1.8 TSI/2.0 TSI (2009-2015), Passat CC 1.8 TSI/2.0 TSI (2009-2012), Scirocco 2.0 TSI (2009-2016), Sharan 1.8 TSI/2.0 TSI (2011-2016), Tiguan 2.0 TSI (2008-2016)
 Audi: BYT, BZB, CABA, CABB, CABD, CAEA, CAEB, CAED, CBFA, CCTA, CCZA, CCZC, CDA, CDHA, CDHB, CDN, CDNC, CESA, CETA, CHJA, CPMA, CPMB, CPSA; Skoda: CCZA; VW: CAWB, CBFA, CCTA, CCZA, CCZB

EN Camshaft joint sleeve
PL Nasadka do regulacji faz rozrządu
DE Aufsatz zur Regelung der Nockenwellenphasenverstellung
RU Насадка для регулировки фаз газораспределения
CZ Nástavec pro regulaci časování ventilů
HU Vezérfésállító dugókulcs
RO Dispozitiv pt. montat manson axa cu came
FR Manchon de déphasage d'arbre à cames
IT Attacco per sincronizzatore albero a camme
ES Vaso para girar el árbol de levas
CN 调节气门正时帽



VAG: Audi: A3 & A3 Sportback (12-16), A3 Cabriolet (13-16), A4 (08-15), A4 Quattro (12-15), A5 (09-11), A5 Sportback (09-16), A5 Cabriolet (09-12), A5 Coupe (13-16), Q5 (05-17), TT (15-18); Seat: Alhambra (11-16), Altea, Altea XL & Altea Freerack (09-16), Exeo (09-16), Leon (09-17), Leon ST (13-17); Skoda: Octavia II (08-13), Octavia III (13-17), Superb II (08-15), Superb III (15-17), Yeti (13-15); VW: Beetle (13-16), CC (12-15), EOS (08-15), Golf V & VI (09-13), Golf VII (12-15), Golf Alltrack (14-17), Jetta VI (11-16), Jetta V (05-11), Passat (11-17), Tiguan (07-15), Touran (14-17)
 1.8 TFSI: CDA, CDAB, CDHA, CDHB, CJEB, CJEE, CJS, CJSB, CJEB, 2.0 TFSI: CNCD, CNCE, CNDC, CDNB, CDNC, CFKA, CPSA

YATO
YT-06335 3/8" (9.5 mm) 80

EN Fuel injection test kit
PL Zestaw diagnostyczny do wtrysku paliwa
DE Diagnosesatz für Prüfung der Kraftstoffespritzung
RU Пневматический набор к тормозным зажимам
CZ Souprava k diagnostice vstřikování paliva
HU Diagnosztikai készlet üzemanyag - befecskendőzőkhöz
RO Ansamblu pt. diagnosticarea injectiei combustibilului
FR Kit de test de débit d'injecteur
IT Set diagnostico per iniettori la benzina
ES Juego de herramientas diagnosticas para la inyección de combustible
CN 燃料注射测试组套



YATO
YT-0670 10

- EN Fuel pressure tester
- PL Miernik ciśnienia paliwa
- DE Kraftstoffmessgerät
- RU Датчик давления топлива
- CZ Měřič tlaku paliva
- HU Üzemanyagnyomás-mérő
- RO Tester presiune combustibil
- FR Kit de testeur de pression d'injection de carburant
- IT Misuratore della pressione del carburante
- ES Medidor de presión de combustible
- CN 燃油压力表



20 PCS	0-1 MPa	0-140 psi
FOR DIESEL ENGINES DO SILNIKÓW DIESLA	FOR GASOLINE ENGINES DO SILNIKÓW BENZYNOWYCH	

YATO  **YT-73025**  6

- EN Compression tester
- PL Miernik ciśnienia sprężania
- DE Druckluftmessgerät
- RU Тестер компрессии
- CZ Měřicí přístroj kompresního tlaku
- HU Kompresszió mérő
- RO Aparat de măsurareea presiunii
- FR Testeur de pression adaptateur cône
- IT Manometro pressione
- ES Medidor de compresión
- CN 气缸压力表



5 PCS	2.1 MPa
M14 M18	FOR SPARK IGNITION DO ZAPŁONU ISKROWEGO
RUBBER ADAPTOR ZŁĄCZE GUMOWE	

YATO  **YT-73011**  10

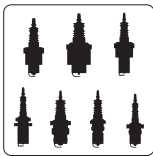





FOR ALL TYPES
DO WSZYSTKICH TYPOW

- EN Compression pressure gauge in a diesel engine
- PL Miernik ciśnienia sprężania w silnikach diesla
- DE Kompressionsdruckmesser in Dieselmotoren
- RU Измеритель давления компрессии в дизельных двигателях
- CZ Souprava k měření kompresních tlaků v dieselových motorech
- HU Dieselmotorok kompresszióját mérő óra
- RO Manometrul presiunii aerului comprimat pt. motoarele diesel
- FR Testeur de pression cylindrique diesel
- IT Tester di compressione per motori diesel
- ES Medidor de presión de la compresión en los motores diesel
- CN 柴油机压力测试组套

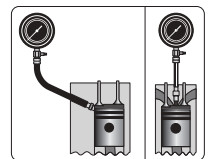

16 PCS	7.0 MPa
FOR DIESEL ENGINES DO SILNIKÓW DIESLA	



-  70 bar, 500 mm;
-  160 mm;
-  M20x1.5: 75 mm; M22x1.5: 73 mm; M24x1.5: 88 mm; M24x2: 63 mm;
-  M10x1: 83, 91, 102, 113, 119 mm; M10x1.25: 64, 135 mm; M12x1.25: 47 mm; M22x1.5: 118 mm;

YATO  **YT-7307**  5

- EN Compression pressure gauge in a diesel engine
- PL Miernik ciśnienia sprężania w silnikach diesla
- DE Kompressionsdruckmesser in Dieselmotoren
- RU Измеритель давления компрессии в дизельных двигателях
- CZ Souprava k měření kompresních tlaků v dieselových motorech
- HU Dieselmotorok kompresszióját mérő óra
- RO Manometrul presiunii aerului comprimat pt. motoarele diesel
- FR Testeur de pression cylindrique diesel
- IT Tester di compressione per motori diesel
- ES Medidor de presión de la compresión en los motores diesel
- CN 柴油机压力测试组套



19 PCS	7.0 MPa
FOR DIESEL ENGINES DO SILNIKÓW DIESLA	

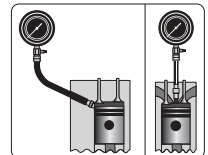

YATO  **YT-73072**  10

EN Compression tester
PL Miernik ciśnienia sprężania
DE Druckluftmessgerät
RU Тестер компрессии
CZ Měřicí přístroj kompresního tlaku
HU Kompresszió mérő
RO Aparat de măsurarea presiunii
FR Testeur de pression adapteur cône
IT Manometro pressione
ES Medidor de compresión
CN 气缸压力表



50
PCS

4.0
MPa

FOR DIESEL ENGINES
DO SILNIKÓW
DIELSIA

FOR GASOLINE ENGINES
DO SILNIKÓW
BENZYNOWYCH

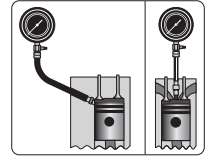
YATO 
YT-73012

4

EN Engine and transmission oil pressure test kit
PL Zestaw mierników ciśnienia oleju silnika i skrzyni biegów
DE Motor- und Öldruck-Test-Set
RU Набор для измерения давления масла в двигателе и АКПП
CZ Sada pro měření tlaku motorového a převodového oleje
HU Motor- és sebességváltó olajnyomás mérő készlet
RO Kit de testare a presiunii uleiului de motor și transmisie
FR Kit de test de pression d'huile dans le moteur et la boîte de vitesses
IT Kit di misuratori di pressione dell'olio nel motore e nel cambio
ES Juego de manómetros presión de aceite en motor y caja
CN 机油高低压测试工具



17
PCS

0-2.75
MPa

0-400
psi

0-0.7
MPa

0-100
psi

1.85m

FOR DIESEL ENGINES
DO SILNIKÓW
DIELSIA

FOR GASOLINE ENGINES
DO SILNIKÓW
BENZYNOWYCH



Included: pressure gauges: 0-400 PSI, 0-100 PSI (2 PCS); flexible hose 185 cm; adaptors (14 PCS): 1/8-27 NPT x 2, 3/8-18 NPT (M) x 1/8-27 (F), 1/4-18 NPT (M) x 1/8-27 NPT (F), 1/4-18 NPT (M) x 1/8-27 NPT (M), 1/8-27 NPT (F), 1/8-27 NPT (M) x 1/8-27 NPT (F, elbow), M8 x 1.0 x 1/8-27 NPT (F), M10 x 1.0 x 1/8-27 NPT (F), M12 x 1.75 x 1/8-27 NPT (F), 1/8-28 BSPT x 1/8-27 NPT (F), 1/16-27 NPT (M) x 1/8-27 NPT (F)
W zestawie: manometry: 0-400 PSI, 0-100 PSI (2 szt.); elastyczny wąż 185 cm; adaptery (14 szt.): 1/8-27 NPT x 2, 3/8-18 NPT (M) x 1/8-27 (F), 1/4-18 NPT (M) x 1/8-27 NPT (F), 1/4-18 NPT (M) x 1/8-27 NPT (M), 1/8-27 NPT (F), 1/8-27 NPT (M) x 1/8-27 NPT (F, kątowny), M8 x 1.0 x 1/8-27 NPT (F), M10 x 1.0 x 1/8-27 NPT (F), M12 x 1.75 x 1/8-27 NPT (F), 1/8-28 BSPT x 1/8-27 NPT (F), 1/16-27 NPT (M) x 1/8-27 NPT (F)

YATO 
YT-73032

10

EN Compression tester kit
PL Miernik ciśnienia sprężania - benzyna
DE Kompressionsmessgerät - Ottomotoren
RU Измеритель давления сжатия - бензин
CZ Kompresní tlakoměr - benzín
HU Benzin kompresszió mérő
RO Kit tester compresie
FR Manomètre de compression pour moteur à essence
IT Tester di compressione per motori a benzina
ES Medidor de presión de compresión, gasolina
CN 汽油压力表



8
PCS

0-2
MPa

0-300
psi

FOR GASOLINE ENGINES
DO SILNIKÓW
BENZYNOWYCH



YATO 
YT-73022

6

EN Oil combustion spraying pressure meter
PL Miernik ciśnienia wtrysku paliwa
DE Kraftstoff-Einspritzdruckmessgerät
RU Измеритель давления впрыска топлива
CZ Měřič tlaku vstřikování paliva
HU Üzemanyag befecskendező nyomásmérő
RO Kit măsurare presiune injectoare
FR Manomètre de pression d'injection du carburant
IT Misuratore della pressione di iniezione del carburante
ES Medidor de presión de inyección de combustible
CN 燃油喷射压力表



9
PCS

0-0.7
MPa

0-100
psi





YATO 
YT-73024

10

- EN Oil combustion spraying pressure meter
- PL Miernik ciśnienia wtrysku paliwa
- DE Kraftstoff-Einspritzdruckmessgerät
- RU Измеритель давления впрыска топлива
- CZ Měřič tlaku vstřikování paliva
- HU Üzemanyag befecskendező nyomásmérő
- RO Kit masurare presiune injectoare
- FR Manomètre de pression d'injection du carburant
- IT Misuratore della pressione di iniezione del carburante
- ES Medidor de presión de inyección de combustible
- CN 燃油喷射压力表



10 PCS **0-0.7** MPa **0-100** psi 

YATO  **YT-73023**  10

- EN Vacuum & fuel pump tester
- PL Wakuometr - miernik pomiaru ciśnienia i podciśnienia
- DE Vakuummessgerät - Druck- und Unterdruckmessgerät
- RU Вакуумметр - прибор для измерения давления и вакуума
- CZ Vakuové měřidlo - zařízení pro měření tlaku a podtlaku
- HU Nyomásmérő és vákuummérő
- RO Tester pompa combustibil
- FR Vacuomètre - manomètre de mesure de pression et de dépression
- IT Vacuometro - misuratore della pressione-depressione
- ES Vacuómetro: medidor de presión y presión negativa
- CN 真空压力表





9 PCS **0-0.1** MPa **0-14** psi 

YATO  **YT-73050**  10

- EN Oil pressure tester
- PL Miernik ciśnienia oleju
- DE Öldruckanzeige
- RU Тестер давления масла с адаптерами
- CZ Tester tlaku oleje
- HU Olajnyomásmérő készlet
- RO Tester presiune ulei
- FR Set de testeurs de pression d'huile
- IT Tester misurazione pressione dell'olio
- ES Manómetro de aceite
- CN 自动波箱压力表



12 PCS **3.5** MPa **185cm** 
FOR ALL TYPES OF ENGINES DO WSKYCHKACH TYPOW SILNIKOW 

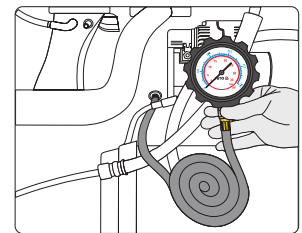

YATO  **YT-73030**  10

- EN Oil pressure tester
- PL Miernik ciśnienia oleju
- DE Öldruckanzeige
- RU Тестер давления масла с адаптерами
- CZ Tester tlaku oleje
- HU Olajnyomásmérő készlet
- RO Tester presiune ulei
- FR Set de testeurs de pression d'huile
- IT Tester misurazione pressione dell'olio
- ES Manómetro de aceite
- CN 油压压力表



12 PCS **0-1** MPa **0-140** psi **125cm** 
FOR ALL TYPES OF ENGINES DO WSKYCHKACH TYPOW SILNIKOW 

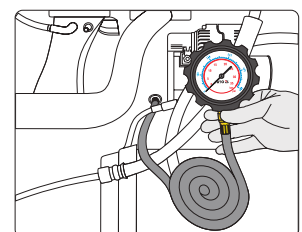

YATO  **YT-73031**  10

Adapters / adaptery: R1/8 DIN 2999; 1/8" 27 NPT; 1/4" 18 NPT; 3/8" 20 UNF; 1/2" 20 UNF; M10 x 1.0; M12 x 1.5; M14 x 1.5; M16 x 1.5; M18 x 1.5

- EN Cylinder leak detector
PL Zestaw do pomiaru szczelności cylindrów
DE Zylinder-Druckverlust-Tester
RU Набор для измерения герметичности цилиндра
CZ Sada pro měření těsnosti válců
HU Kompresszióvénymás-mérő készlet
RO Dispozitiv detectare pierdere presiune cilindrii
FR Ensemble de mesure d'étanchéité des vérins
IT Kit per la misura di tenuta cilindri
ES Kit para medir fugas de cilindros
CN 汽缸测漏表



4 PCS
0.7 MPa
FOR GASOLINE ENGINES DO SILNIKÓW BENZYNOWYCH
STANDARD 

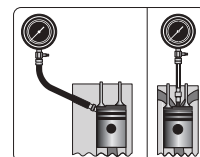

YATO 

YT-73055



5

- EN Common cool gas meter
PL Zestaw do obsługi systemów klimatyzacji
DE Bedienungssatz für Klimasysteme
RU Комплект для эксплуатации систем кондиционирования
CZ Sada pro obsluhu klimatizačních systémů
HU Klíma szivárgáskereső készlet
RO Manometru pt. gaz
FR Ensemble pour la maintenance des systèmes de climatisation
IT Kit manutenzione per impianto aria condizionata
ES Kit de operación de sistemas de aire acondicionado
CN 冷媒表



6 PCS
0-0.8 MPa
0-3.4 MPa
R-134a
145 cm 

YATO 

YT-72990



6

- EN Ozone generator
PL Generator ozonu
DE Ozon-Generator
RU Генератор озона
CZ Generátor ozónu
HU Ózongenerátor
RO Generator ozon
FR Générateur d'ozone
IT Generatore di ozono
ES Generador de ozono
CN 臭氧机



110-230V-50/60Hz
220 W
10 g/h
0-90 min 

YATO 

YT-73350

[W]

220



4

- EN Compression tester
PL Miernik ciśnienia sprężania
DE Druckluftmessgerät
RU Тестер компрессии
CZ Měřicí přístroj kompresního tlaku
HU Kompresszió mérő
RO Aparat de măsurareea presiunii
FR Testeur de pression adapteur cône
IT Manometro pressione
ES Medidor de compresión
CN 汽缸压力表

2.1 MPa
FOR SPARK IGNITION DO ZAPLONU ISKROWEGO
RUBBER CONNECTOR ZŁĄCZE GUMOWE 



FOR ALL TYPES DO WSZYSTKICH TYPÓW

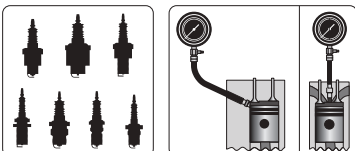

YATO 

YT-7300



24/48

- EN Compression tester
PL Miernik ciśnienia sprężania
DE Druckluftmessgerät
RU Тестер компрессии
CZ Měřicí přístroj kompresního tlaku
HU Kompresszió mérő
RO Aparat de măsurareea presiunii
FR Testeur de pression adapteur cône
IT Manometro pressione
ES Medidor de compresión
CN 汽缸压力表

2.1 MPa
FOR SPARK IGNITION DO ZAPLONU ISKROWEGO
THREADED ADAPTER ZŁĄCZE GWINTOWANE 



FOR ALL TYPES DO WSZYSTKICH TYPÓW

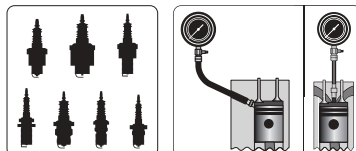

YATO 

YT-7301



12/24

EN Compression tester
 PL Miernik ciśnienia sprężania
 DE Druckluftmessgerät
 RU Тестер компрессии
 CZ Měřicí přístroj kompresního tlaku
 HU Kompresszió mérő
 RO Aparat de măsurareea presiunii
 FR Testeur de pression adapteur cône
 IT Manometro pressione
 ES Medidor de compresión
 CN 气缸压力表组套



2.1 MPa

FOR SPARK IGNITION DO ZAPALONU ISKROWEGO

THREADED ADAPTER ZŁĄCZE GWINTOWANE

RUBBER CONNECTOR ZŁĄCZE GUMOWE



EN Injecton nozzle tester
 PL Tester wtryskiwaczy
 DE Einspritz-Tester
 RU Тестер форсунок
 CZ Tester vstřikovačů
 HU Porlasztó vizsgáló teszter
 RO Tester de duze de injectie
 FR Testeur d'injecteur de carburant
 IT Tester per iniettori
 ES Comprobador de inyectoros
 CN 喷油嘴枝检器

60 MPa (max.)

600 ml

M12

M14

FOR DIESEL ENGINES DO SILNIKOW DIESLA



FOR ALL TYPES DO WSZYSTKICH TYPÓW

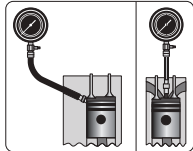
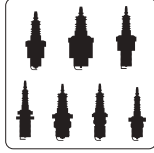

YATO
 YT-7302

6/24

YATO
 YT-72963

4

EN Flow meter common rail adapter set
 PL Przelewowy zestaw diagnostyczny do wtryskiwaczy Common Rail
 DE Überlauf-Diagnosesatz für Einspritzdüse Common Rail
 RU Диагностический набор к форсунам Common Rail переливной
 CZ Souprava na diagnostiku vstřikovačů Common Rail průtoková
 HU Diagnosztikai készlet Common Rail injektorokhoz, átfolyós
 RO Set diagnostic preaplin pt. injectoare Common Rail
 FR Kit de test de débit d'injecteur Common Rail
 IT Set controllo portata iniettori Common Rail
 ES Juego diagnóstico de flujo para inyectoros Common Rail
 CN 柴油燃油喷油嘴检测工具



31 PCS

FOR 6 CYLINDERS DO 6 CYLINDROW

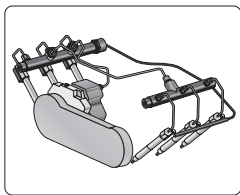

YATO
 YT-7306

5

EN Diesel fuel pump timing set
 PL Prząd do regulacji pomp wtryskowych
 DE Vorrichtung zur Einspritzpumpeneinstellung
 RU Инструмент для регулировки ТНВД
 CZ Nástroj pro regulaci vstřikovacíh čerpadel
 HU Befecskendező szivattyú beállító szerszám
 RO Set de distributie a pompei de combustibil diesel
 FR Outil de réglage des pompes d'injection
 IT Strumento di regolazione pompa di iniezione
 ES Herramienta de ajuste de bombas de inyección
 CN 柴油喷射泵校正器



10 PCS

+/- 0.01 mm



YATO
 YT-05337

5

For fuel pump: Bosch, Denso, Lukas, Nippon
 Dla pomp: Bosch, Denso, Lukas, Nippon

EN Combined sockets for alternator
PL Zestaw do alternatorów ze sprzęgłem
DE Werkzeugsatz für Lichtmaschine
RU Набор для альтернатора
CZ Souprava na opravu alternátoru
HU Generátor szerszámkészlet
RO Garnitură pt. alternator
FR Set de clés à l'alternateur avec l'embrayage
IT Set di chiavi per smontaggio puleggia e alternatore
ES Enchufes combinados para alternador
CN 发动机拆卸组套

13 PCS	1/2" 12.7mm				CrV
HRC 40-44	S45C	HRC 38-42	8660 <small>HIGH-CARBON STEEL FOR HIGH-SPEED STEEL</small>	HRC 53-57	

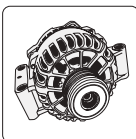

- 1/2" (12.7 mm); M10, HBS, 33T, L=110 mm; CrV; HRC 40-44;
- 1/2" (12.7 mm); T50, HBS, 33T, L=110 mm; CrV; HRC 40-44;
- M8, M10, L=75 mm; 8660; HRC 53-57;
- T40, T50, L=75 mm; 8660; HRC 53-57;
- H8, H10, L=75 mm; 8660; HRC 53-57;
- H15, 33T, L=30 mm; CrV; HRC 40-44;
- H22, 33T, L=30 mm; CrV; HRC 40-44;
- H22, L=30 mm; S45C; HRC 38-42;
- Ø 35 x 30 mm; CrV; HRC 40-44;
- 1/2" (12.7 mm) x 10 mm; CrV; HRC 40-44



YATO	○	
YT-0421	1/2" (12.7 mm)	15

EN Combined sockets for alternator
PL Zestaw do alternatorów ze sprzęgłem
DE Werkzeugsatz für Lichtmaschine
RU Набор для альтернатора
CZ Souprava na opravu alternátoru
HU Generátor szerszámkészlet
RO Garnitură pt. alternator
FR Set de clés à l'alternateur avec l'embrayage
IT Set di chiavi per smontaggio puleggia e alternatore
ES Enchufes combinados para alternador
CN 发动机拆卸组套

22 PCS	1/2" 12.7mm	3/8" 9.5mm				CrV
HRC 40-44	S45C	HRC 38-42	8660 <small>HIGH-CARBON STEEL FOR HIGH-SPEED STEEL</small>	HRC 53-57		

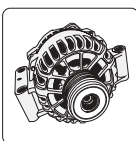

- 1/2" (12.7 mm); M10, HBS, 33T, L=113 mm; CrV; HRC 40-44 / 8660; HRC 53-57;
- 1/2" (12.7 mm); T50, HBS, 33T, L=113 mm; CrV; HRC 40-44 / 8660; HRC 53-57;
- 3/8" (10 mm); M10, HBS, 33T, L=80 mm; CrV; HRC 40-44 / 8660; HRC 53-57;
- 1/2" (12.5 mm); M10, HBS, 33T, L=140 mm; CrV; HRC 40-44;
- M8, M10, L=75 mm; 8660; HRC 53-57;
- T40, T50, L=75 mm; 8660; HRC 53-57;
- H8, H10, L=75 mm; 8660; HRC 53-57;
- M8xH12, L=64 mm; 8660; HRC 53-57;
- H15, 33T, Ø 17 mm, L=30 mm, H15, 33T, Ø 19 mm, L=30 mm; CrV; HRC 40-44;
- H17, H22, L=30 mm; S45C; HRC 38-42;
- Ø 35 x 30 mm; S45C; HRC 38-42;
- Ø 38 mm; S45C; HRC 38-42;
- H19x28, H21x28, H22x28; S45C; HRC 38-42;
- 1/2" (12.5 mm) (F) x H10 mm (F); CrV; HRC 40-44



YATO	○	
YT-0421	3/8" (9.5 mm), 1/2" (12.7 mm)	5

EN Stroboscopic tube
PL Lampa stroboskopowa
DE Stroboskoplampe
RU Стробоскопная лампа
CZ Stroboskopická lampa
HU Stroboszkóp lámpa

RO Lampă stroboscopică
FR Lampe stroboscopique
IT Lampada stroboscopica
ES Tubo estroboscópico
CN 点火正时灯

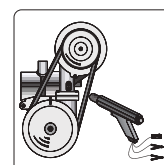

12V	max 8000 min ¹	
	XENON	



0-60°

YATO	
YT-7310	6/12

YATO	
YT-7311	6/12

YATO	
YT-7312	6/12

EN Universal radiator pressure kit
 PL Zestaw diagnostyczny do chłodnicy
 DE Diagnosekit für Kühler
 RU Диагностический набор к радиатору
 CZ Souprava k diagnostice chladiče
 HU Diagnosztikai készlet hűtőkhöz
 RO Ansamblu pt. diagnosticarea radiatorului
 FR Set diagnostique pour radiateur de voiture
 IT Set universale tester pressione del radiatore
 ES Juego de herramientas diagnosticas para el radiador
 CN 万用水箱压力测试组套

14
PCS **0.25**
MPa (max) **max°C**
200

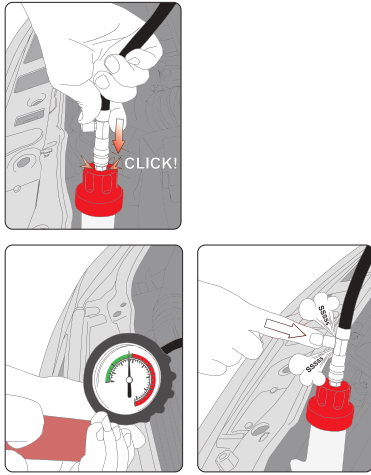

Acura, Alfa Romeo, Audi, BMW, Chrysler, Citroen, Fiat, Ford, General Motors, GEO, Honda, Infiniti, Isuzu, Jaguar, Jeep, Land Rover, Mazda, Mercedes, Mitsubishi, Nissan, Opel, Peugeot, Porsche, Renault, Saab, Subaru, Suzuki, Toyota, Volkswagen, Volvo

YATO
YT-0672 4

EN Cooling system vacuum purge and refill kit
 PL Zestaw do próżniowego napełniania układu chłodzenia
 DE Kühlsystem Vakuum Entleer- und Befüll-Set
 RU Комплект для вакуумной заправки системы охлаждения
 CZ Sada pro vakuové plnění chladičoho systému
 HU Vákuumos hűtőrendszer feltöltő
 RO Kit încarcare și aerisire în vid pt. sistem răcire
 FR Kit d'outils de remplissage sous vide de liquide de refroidissement
 IT Kit di riempimento del sistema di raffreddamento sottovuoto
 ES Kit de llenado al vacío del sistema de refrigeración
 CN 防冻液加注器

3
PCS **-1**
bar \varnothing 15-45
mm

EN Water tank leak detector
 PL Zestaw do diagnostyki i obsługi układu chłodzenia
 DE Diagnose- und Wartungssatz für Kühlkreis
 RU Комплект для диагностики и обслуживания системы охлаждения
 CZ Sada pro diagnostiku a servis chladičoho systému
 HU Hűtőrendszer diagnosztikai és szerviz készlet
 RO Detector scurgeri rezervor apa
 FR Kit de diagnostic de système de refroidissement
 IT Kit di diagnostica e utilizzo del sistema di raffreddamento
 ES Kit de diagnóstico y manejo del sistema de refrigeración
 CN 水箱测漏仪

28
PCS **0.25**
MPa (max)



Acura; Alfa Romeo; Audi: A4, A5, A6; Audi VW (1975-1993); BMW: 345, E32, E34, E36, E38, E39, E46, E60, E63, E64, E65, E90; Buick; Cadillac; Chevrolet; Citroen; Chrysler; Daewoo; Dodge; Eagle; Fiat; Ford: C-Max, Focus, Mondeo, USA versions etc.; General Motors; GMC; Honda; Hummer; Hyundai; Infiniti; International; Isuzu; Jaguar; Jeep; Kia; Land Rover; Lexus; Lincoln; Mazda: M3 etc.; Mercedes-Benz: A, C, E, M, S Class (W140, W168, W210, W211, W215, W216, W220, R230), W123, W126, W124, W201, Vito; Mercury; Mini; Mini Cooper; Mitsubishi; Nissan; Oldsmobile; Opel; Peugeot; Pontiac; Porsche: Cayenne etc.; Renault; Saab; Saturn; Ssangyong; Sterling; Subaru; Suzuki; Toyota: Celica, MR2, Previa, RAV4 etc.; Vauxhall; Volvo; VW: Beetle, Golf, Passat (1996, 1997-2002), Sharan (1.8T, 2.8), T4, Vento

YATO
YT-72995 10

YATO
YT-06721 3

- EN Cooling system vacuum purge and refill kit
PL Zestaw do próżniowego napełniania układu chłodzenia
DE Kühlsystem Vakuum Entleer- und Befüll-Set
RU Комплект для вакуумной заправки системы охлаждения
CZ Sada pro vakuové plnění chladicího systému
HU Vákuumos hűtőrendszer feltöltő
RO Kit încarcare și aerisire în vid pt. sistem răcire
FR Kit d'outils de remplissage sous vide de liquide de refroidissement
IT Kit di riempimento del sistema di raffreddamento sottovuoto
ES Kit de llenado al vacío del sistema de refrigeración
CN 防冻液加注器



6
PCS

-1
bar

∅
30-48
mm



YATO 

YT-72996



10

- EN Water pump tester
PL Tester pompy wodnej i układu chłodzenia
DE Wasserpumpen- und Kühlsystemtester
RU Тестер водяного насоса системы охлаждения
CZ Tester vodního čerpadla chladicího systému
HU Vízpumpa-vizsgáló készlet
RO Tester pompa de apă
FR Testeur de pompe à eau et système de refroidissement
IT Tester della pompa dell'acqua nel sistema di raffreddamento
ES Probador para bombas de agua y circuito de refrigeración
CN 水泵测试工具



8
PCS

0-0.1
MPa

0-15
psi



YATO 

YT-73065



10

- EN Hand-held vacuum pump
PL Pompka podciśnieniowa z akcesoriami
DE Unterdruckpumpe mit Zubehör
RU Насос вакуумметрического давления с принадлежностями
CZ Podtlaková-tlaková pumpa s příslušenstvím
HU Vákuum- és ac-pumpa mérő, tartozékokkal
RO Pompa de vidare cu accesorii
FR Pompe à vide avec les accessoires
IT Pompa a pressione con accessori
ES Bomba de subpresión con accesorios
CN 手持式真空泵

16
PCS

-1-0
bar



- EN Hand-held vacuum pump
PL Pompka ciśnieniowo-podciśnieniowa z akcesoriami
DE Unterdruck-druckpumpe mit Zubehör
RU Насос вакуумметрического давления с принадлежностями
CZ Podtlaková-tlaková pumpa s příslušenstvím
HU Vákuum- és ac-pumpa mérő, tartozékokkal
RO Pompa de vidare cu accesorii
FR Pompe à vide avec les accessoires
IT Pompa a pressione con accessori
ES Bomba de subpresión-presión con accesorios
CN 手持式真空泵

22
PCS

-1-3
bar



YATO 

YT-0673



10



YATO 

YT-0674



5

EN Flexible line clamp
 PL Komplet zacisków do przewodów z cieczą
 DE Schlauchklemmensatz
 RU Набор зажимов с фиксатором
 CZ Sada hadicových svěrek
 HU Flexibilis cső elszorító készlet
 RO Clema flexibilă
 FR Set de pices pour serrer les
 IT Set pinze per chiudere momentaneamente i manicotti
 ES Juego de alicates apretadores para conductos de líquidos
 CN 油管封口钳组套

3 PCS
 NON-CUTTING
 NIETNACE
 NON-CONDUCTIVE
 NEPRZE-
 WODZĄCE



• 1/4"-3/4" (6.3-19 mm) for brake and fuel lines
 • 1/2"-5/4" (12.5-32 mm) for flexible hose
 • 3/4"-9/4" (19-57 mm) for radiator hose clamp
 • 1/4"-3/4" (6.3-19 mm) do przewodów hamulcowych i paliwowych
 • 1/2"-5/4" (12.5-32 mm) do przewodów elastycznych
 • 3/4"-9/4" (19-57 mm) do przewodu chłodnicy

YATO
 YT-0840 25/50

EN Flexible line clamp
 PL Komplet zacisków do przewodów z cieczą
 DE Schlauchklemmensatz
 RU Набор зажимов с фиксатором
 CZ Sada hadicových svěrek
 HU Flexibilis cső elszorító készlet
 RO Clema flexibilă
 FR Set de pices pour serrer les
 IT Set pinze per chiudere momentaneamente i manicotti
 ES Juego de alicates apretadores para conductos de líquidos
 CN 油管夹

3 PCS
 NON-CUTTING
 NIETNACE
 BENT
 WYGIĘTE
 NON-CONDUCTIVE
 NEPRZE-
 WODZĄCE

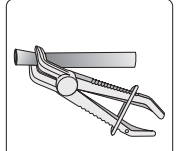

• Max. 13 mm - for brake and fuel lines
 • Max. 17 mm - for flexible hose
 • Max. 32 mm - for radiator hose clamp
 • Max. 13 mm - do przewodów hamulcowych i paliwowych
 • Max. 17 mm - do przewodów elastycznych
 • Max. 32 mm - do przewodu chłodnicy

YATO
 YT-08403 5/15

EN Steel line clamp
 PL Zaciski do przewodów metalowych
 DE Klemmen für Leitungen aus Metall
 RU Клеммы для металлических проводов
 CZ Svorky pro kovové vodiče
 HU Csipesz fém vezetékhez
 RO Set pt. blocare conducte de combustibil si conducte de frane
 FR Pince d'arrêt de conduites métalliques
 IT Morsetti per conduttori metallici
 ES Abrazaderas para conductos de metal
 CN 油管夹

4 PCS
 NYLON
 FOR STEEL
 LINES
 DO
 PRZEWODÓW
 METALOWYCH



YATO
 YT-08390 10/20

EN Steel line clamp
 PL Zaciski do przewodów metalowych
 DE Klemmen für Leitungen aus Metall
 RU Клеммы для металлических проводов
 CZ Svorky pro kovové vodiče
 HU Csipesz fém vezetékhez
 RO Set pt. blocare conducte de combustibil si conducte de frane
 FR Pince d'arrêt de conduites métalliques
 IT Morsetti per conduttori metallici
 ES Abrazaderas para conductos de metal
 CN 油管夹

8 PCS
 NYLON
 FOR STEEL
 LINES
 DO
 PRZEWODÓW
 METALOWYCH



YATO
 YT-08391 10

EN Fuel line clamp and stopper kit
 PL Zestaw zacisków do przewodów metalowych i elastycznych
 DE Satz von Klemmen für flexible Leitungen und Leitungen aus Metall
 RU Набор клемм для металлических и гибких проводов
 CZ Sada svorek pro kovové a elastické vodiče
 HU Csipeszkészlet fém és rugalmas vezetékhez
 RO Cleme pt. conducte combustibil si kit opritor
 FR Ensemble de pinces d'arrêt de conduites métalliques et en plastique
 IT Morsettiera per conduttori metallici elastici
 ES Juego de abrazaderas para conductos de metal y flexibles
 CN 燃油管夹

12 PCS
 NYLON
 FOR STEEL
 AND FLEXIBLE LINES
 DO PRZEWODÓW
 METALOWYCH
 ELASTYCZNYCH



YATO
 YT-08392 5

EN Spark plug socket
PL Nasadka do świec
DE Steckschlüssel mit Gummihalterung
RU Головка свечная
CZ Nastavec pro svíčky
HU Gyújtógyertyya toldalék
RO Cheie de bujii
FR Douille à bougies
IT Chiave a bussola per candele
ES Boquilla de bujías
CN 火花塞套筒

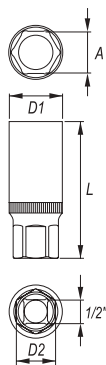

YATO	Ø	A [mm]	D1 [mm]	D2 [mm]	L [mm]	PCS PKG	📦
YT-1253	1/2" (12.7 mm)	16	22	19	64	10	50/100
YT-1254	1/2" (12.7 mm)	21	27.8	24	64	10	50/100

EN Spark plug socket
PL Nasadka do świec
DE Steckschlüssel mit Gummihalterung
RU Головка свечная
CZ Nastavec pro svíčky
HU Gyújtógyertyya toldalék
RO Cheie de bujii
FR Douille à bougies
IT Chiave a bussola per candele
ES Boquilla de bujías
CN 六角火花塞套筒

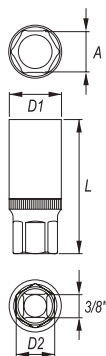

YATO	Ø	A [mm]	D1 [mm]	D2 [mm]	L [mm]	PCS PKG	📦
YT-3851	3/8" (9.5 mm)	16	22	19	64	10	50/100

EN Spark plug socket
PL Nasadka do świec
DE Steckschlüssel mit Gummihalterung
RU Головка свечная
CZ Nastavec pro svíčky
HU Gyújtógyertyya toldalék
RO Cheie de bujii
FR Douille à bougies
IT Chiave a bussola per candele
ES Boquilla de bujías
CN 磁性十二角薄壁火花塞套筒

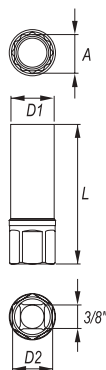

YATO	Ø	A [mm]	D1 [mm]	D2 [mm]	L [mm]	PCS PKG	📦
YT-38510	3/8" (9.5 mm)	14	18	16	63	25/100	

EN Spark plug socket
PL Nasadka do świec
DE Steckschlüssel mit Gummihalterung
RU Головка свечная
CZ Nastavec pro svíčky
HU Gyújtógyertyya toldalék
RO Cheie de bujii
FR Douille à bougies
IT Chiave a bussola per candele
ES Boquilla de bujías
CN 火花塞套筒

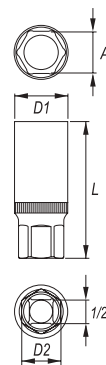

YATO	Ø	A [mm]	D1 [mm]	D2 [mm]	L [mm]	PCS PKG	📦
YT-12531	1/2" (12.7 mm)	16	22.0	19	64	10/160	
YT-12541	1/2" (12.7 mm)	21	27.8	24	64	10/120	

EN Spark plug socket
PL Nasadka do świec
DE Steckschlüssel mit Gummihalterung
RU Головка свечная
CZ Nastavec pro svíčky
HU Gyújtógyertyya toldalék
RO Cheie de bujii
FR Douille à bougies
IT Chiave a bussola per candele
ES Boquilla de bujías
CN 六角火花塞套筒

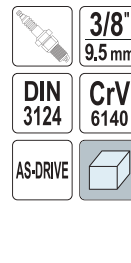
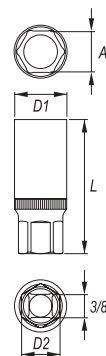

YATO	Ø	A [mm]	D1 [mm]	D2 [mm]	L [mm]	PCS PKG	📦
YT-3841	3/8" (9.5 mm)	18	25.8	19	63	10	50/100

EN Spark plug socket
PL Nasadka do świec
DE Steckschlüssel mit Gummihalterung
RU Головка свечная
CZ Nastavec pro svíčky
HU Gyújtógyertyya toldalék
RO Cheie de bujii
FR Douille à bougies
IT Chiave a bussola per candele
ES Boquilla de bujías
CN 磁性十二角薄壁火花塞套筒

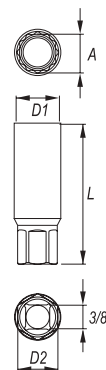

YATO	Ø	A [mm]	D1 [mm]	D2 [mm]	L [mm]	PCS PKG	📦
YT-38511	3/8" (9.5 mm)	16	20	16	62	25/100	

- EN Spark plug socket
- PL Nasadka do świec
- DE Steckschlüssel mit Gummihaltering
- RU Головка свечная
- CZ Nastavec pro svíčky
- HU Gyújtógyertya toldalék
- RO Cheie de buji
- FR Douille à bougies
- IT Chiave a bussola per candele
- ES Boquilla de bujías
- CN 磁性万向十二角火花塞套筒

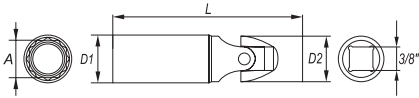

YATO	Ø	A [mm]	D1 [mm]	D2 [mm]	L [mm]	Box
YT-38512	3/8" (9.5 mm)	14	20	19	88	25/100

- EN Spark plug socket
- PL Nasadka do świec
- DE Steckschlüssel mit Gummihaltering
- RU Головка свечная
- CZ Nastavec pro svíčky
- HU Gyújtógyertya toldalék
- RO Cheie de buji
- FR Douille à bougies
- IT Chiave a bussola per candele
- ES Boquilla de bujías
- CN 火花塞套筒

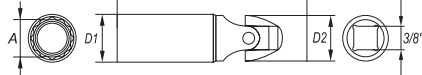
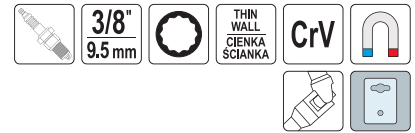

YATO	Ø	A [mm]	D1 [mm]	D2 [mm]	L [mm]	Box
YT-38516	3/8" (9.5 mm)	14	19	19	98	25/100
YT-38517	3/8" (9.5 mm)	16	20	19	98	25/100

- EN Spark plug socket
- PL Klucz do świec z przedłużką
- DE Kerzenschlüssel mit Verlängerungshebel
- RU Ключ к свечам с удлинителем
- CZ Klíč na svíčky s prodlužovacím nástavcem
- HU Gyertyakulcs hosszabbítóval
- RO Cheie cu prelungitor, pt. buji
- FR Douille à bougies
- IT Chiavi per candele a tubo
- ES Llave para las bujías con extensión
- CN 加长带磁万向火星



YATO	A [mm]	L [mm]	Box
YT-0817	16	290	10/40

- EN Extra long spark plug socket
- PL Nasadka do świec extra długa
- DE Zündkerzensteckschlüssel, extra lang
- RU Удлиненная насадка для свечи
- CZ Násada do svíček extra dlouhá
- HU Gyertyakulcs extra hosszú
- RO Cheie bujii lunga
- FR Douille pour bougie d'allumage extra longue
- IT Chiave a bussola per candele extra lungo
- ES Vaso para bujías extra largo
- CN 十二角加长火花塞磁钢款



YATO	A [mm]	Box
YT-38521	14	12/48
YT-38522	16	12/48

- EN Spark plug socket
- PL Klucz do świec z przedłużką
- DE Kerzenschlüssel mit Verlängerungshebel
- RU Ключ к свечам с удлинителем
- CZ Klíč na svíčky s prodlužovacím nástavcem
- HU Gyertyakulcs hosszabbítóval
- RO Cheie cu prelungitor pt. buji
- FR Douille à bougies
- IT Chiavi per candele a tubo
- ES Llave para las bujías con extensión
- CN 加长带磁万向火星



YATO	A [mm]	Box
YT-08163	14	15/60
YT-08164	16	15/60
YT-0818	18	10/40

- EN Spark plug socket set
- PL Zestaw nasadek do świec
- DE Satz der Zündkerzenaufsätze
- RU Набор головок для свечей накаливания
- CZ Sada nástavců na svíčky
- HU Gyújtógyertya-kulcs készlet
- RO Set chei pt. buji
- FR Ensemble d'embouts pour bougies d'allumage
- IT Set di prese per candele di accensione
- ES Juego de casquillos para bujías
- CN 摇头火花塞组套



3/8" (9.5 mm): 14, 16, 18, 21 mm

YATO	Ø	Box
YT-38520	3/8" (9.5 mm)	5/20

- EN Joined glow plug socket set
- PL Zestaw kluczy do świec Zarowych
- DE Schlüsselsatz für Glühkerzen
- RU Набор ключей к калильным свечам
- CZ Sada klíčů na žhavicí svíčky
- HU Gyertyakulcs készlet
- RO Set chei pt. bujii incandescente
- FR Set de douilles à bougies
- IT Set chiavi a bussola snodate per candele
- ES Juego de llaves para bujías incandescentes
- CN 预热火花塞套筒组套

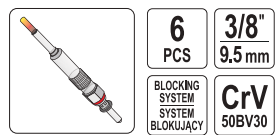

3/8" (9.5 mm): 8, 9, 10, 12, 14, 16 mm

YATO	Ø	Box
YT-0534	3/8" (9.5 mm)	10

- EN Joined glow plug socket set
PL Zestaw kluczy do świec żarowych
DE Schlüsselsatz für Glühkerzen
RU Набор ключей к калильным свечам
CZ Sada klíčů na žhavičí svíčky
HU Gyertyakulcs készlet
RO Set chei pt. bujii incandescente
FR Set de douilles à bougies
IT Set chiavi a bussola snodate per candlette
ES Juego de llaves para bujías incandescentes
CN 预热火花塞套筒组套

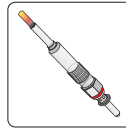

6 PCS
3/8" 9.5 mm
CrV



3/8" (9.5 mm): 8, 9, 10, 12, 14, 16 mm

YATO
YT-05339 3/8" (9.5 mm) 10

- EN Torque angle gauge with magnet
PL Kałomierz z magnesem do klucza dynamometrycznego
DE Winkelmesser mit Magnet für Drehmomentschlüssel
RU Транспортир с магнитом для динамометрического ключа
CZ Úhloměř s magnetem na momentový klíč
HU Mágneses szögmérő nyomatékkulcshoz
RO Cheie dinamometrica cu magnet
FR Rapporteur avec aimant pour clé dynamométrique
IT Goniometro con magnete per chiave dinamometrica
ES Escuadra con imán para llave dinámométrica
CN 磁性扭力规

1/2" 12.7 mm
360°
35 cm
GRADUATION OF 2 DEGREES
POZIŁAKA PO 2 STOPNIE



YATO
YT-05934 1/2" (12.7 mm) 10/40

- EN Metal conduit bender
PL Giełarka do przewodów metalowych
DE Biegevorrichtung für Metallleitungen
RU Гибочный станок для проводов из металла

- CZ Ohýbačka kovových trubek
HU Hajlító fémvezetékekhez
RO Mașina de îndoit (curbat) pt. cabluri metalice
FR Cintreuse au câble de frein

- IT Piegatrice per fili metallici
ES Dobladora de tubos de metal
CN 弯管器

AI



125 mm max Ø 6.0 mm

YATO
YT-0813 L [mm] 125 24/96



235 mm max Ø 12 mm

YATO
YT-0814 L [mm] 235 6/48

- EN Universal clutch adjustment set
PL Zestaw do centrowania tarczy sprzęgłowej
DE Universal-set, um die Kupplungsscheibe einstellen
RU Комплект для центровки дисков сцепления
CZ Univerzální sada pro nastavení spojky disk
HU Kuplung központosító készlet
RO Trusa pt. centrul ambreiaje
FR Centreur d'embrayage
IT Set di centraggio frizione
ES Herramienta alineación embrague
CN 离合器对孔校正器



9 PCS
11-25 mm

Ø 11, 12, 15, 17, 19, 20, 22, 25 mm

YATO
YT-06311 20

- EN Torque angle gauge
PL Kałomierz do dokręcania śrub
DE Winkelmesser zum Anziehen von Schrauben
RU Угломер для подвѣртыwania болтов
CZ Úhloměř k utahování šroubů
HU Nyomaték szögmérő
RO Raportor pt. înșurubat șuruburi
FR Rapporteur à serrer les vis
IT Goniometro per il serraggio controllo
ES Calibrador para apretar tornillos
CN 扭力角度规

1/2" 12.7 mm
360°
CrV



YATO
YT-0593 1/2" (12.7 mm) 12/48

- EN Torque angle gauge with clamp
PL Kałomierz z uchwytem do klucza dynamometrycznego
DE Winkellehre mit Griff für Drehmomentschlüssel
RU Угломер для динамометрического ключа
CZ Úhloměř s držákem momentového klíče
HU Fogantyús szögmérő nyomatékkulcshoz
RO Dispozitiv masurat unghiuri cu clema
FR Clé de serrage angulaire flexible avec pince, carré
IT Goniometro per chiave dinamometrica
ES Escuadra para soporte de la llave dinámométrica
CN 扭力规

1/2" 12.7 mm

360°

50 cm

GRADUATION OF 2 DEGREES
POZIŁAKA PO 2 STOPNIE



YATO
YT-05933 1/2" (12.7 mm) 6/24

- EN Universal clutch adjustment set
- PL Zestaw do centrowania tarczy sprzęgłowej
- DE Kupplungs-Zentrier-Werkzeug-Satz
- RU Комплект для центровки дисков сцепления
- CZ Univerzální sada pro nastavení spojky disk
- HU Kuplung központositó készlet
- RO Trusa pt. centrare ambreiaje
- FR Centreur d'embrayage
- IT Set di centraggio frizione
- ES Herramienta alineación embrague
- CN 离合器对孔校正器



2 PCS	\varnothing 15-25 mm	\varnothing 20-27 mm	ADJUSTABLE NASTAWNY
-----------------	----------------------------------	----------------------------------	------------------------



- EN Universal clutch adjustment set
- PL Zestaw do centrowania tarczy sprzęgłowej
- DE Kupplungs-Zentrier-Werkzeug-Satz
- RU Комплект для центровки дисков сцепления
- CZ Univerzální sada pro nastavení spojky disk
- HU Kuplung központositó készlet
- RO Trusa pt. centrare ambreiaje
- FR Centreur d'embrayage
- IT Set di centraggio frizione
- ES Herramienta alineación embrague
- CN 离合器调整工具

\varnothing 15-28 mm	3 REDUCTION SLEEVES TULEJE REDUKCYJNE	FOR PASSENGER CARS DO AUT OSOBOWYCH	
----------------------------------	--	---	---



YATO 	
YT-06313	12/24

- EN SAC clutch tool set
- PL Zestaw do obsługi sprzęgieł SAC
- DE SAC-Kupplungswartungssatz
- RU Набор для обслуживания муфт SAC
- CZ Servisní sada pro spojky SAC
- HU SAC kuplung szerelő készlet
- RO Set unelte ambreiaj SAC
- FR Kit de service d'embrayage SAC
- IT Set di attrezzi per smontaggio e montaggio della frizione SAC
- ES Kit de manejo de embragues SAC
- CN 离合器拆装工具

43 PCS	SAC			
------------------	------------	---	---	---



YATO 	
YT-06315	1

YATO 	
YT-06312	25

- EN DSG mechatronic unit remover
- PL Przyrząd do demontażu skrzyni biegów DSG
- DE Demontagevorrichtung für DSG-Schaltgetriebe
- RU Инструмент для разборки коробки передач DSG
- CZ Nástroj pro demontáž převodovky DSG
- HU DSG sebességváltó szerelő szerszám
- RO Hit indepartare unitate mecatronica DSG
- FR Outil de démontage de boîte de vitesses type DSG
- IT Leva per sbloccaggio cambio DSG
- ES Herramienta de desmontaje de caja de cambios DGS
- CN 大众奥迪DSG双离合变速箱阀体拆离器

260 mm	VAG	DSG	
------------------	------------	------------	---



YATO 	
YT-05333	10/40

- EN DSG double clutch tool set
- PL Zestaw do wymiany sprzęgła DSG
- DE DSG-Kupplungs austauschset
- RU Набор для замены сцепления DSG
- CZ Sada na výměnu spojky DSG
- HU DSG kuplung szerelő készlet
- RO Set de instrumente dublu ambreiaj DSG
- FR Kit de remplacement embrayage DSG
- IT Set di attrezzi per smontaggio e montaggio della frizione DSG
- ES Kit para reemplazo de embragues DGS
- CN 大众奥迪变速箱拆卸工具

6 PCS	VAG	DSG	
-----------------	------------	------------	---



YATO 	
YT-06316	2

EN Tubing pipe bending tool pliers
PL Giętarka do przewodów metalowych
DE Metall-Rohrbieger
RU Гибочный станок для металлических проводов
CZ Ohývačka kovových vodičů
HU Csőhajlító fogó
RO Cleste pt. indoirea conductelor
FR Cintreuse de tuyaux métalliques
IT Piegatrice per fili metallici
ES Dobladora de tubos de metal
CN 弯管器



YATO L [mm]
YT-08144 255 6/24

EN Brake fluid tester
PL Tester płynu hamulcowego
DE Bremsflüssigkeitstester
RU Тестер тормозной жидкости
CZ Tester stavu brzdové kapaliny
HU Fékolyadék tesztler
RO Tester lichid frana
FR Tester de liquide de frein
IT Tester del fluido frenante
ES Líquido de frenos tester
CN 刹车油检测器

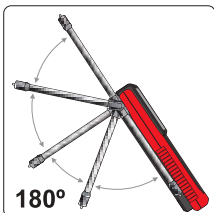

YATO
YT-72981 28/56

EN Brake fluid tester
PL Tester płynu hamulcowego
DE Bremsflüssigkeitstester
RU Тестер тормозной жидкости
CZ Tester stavu brzdové kapaliny
HU Fékolyadék tesztler
RO Tester lichid frana
FR Tester de liquide de frein
IT Tester del fluido frenante
ES Líquido de frenos tester
CN 刹车油测试仪

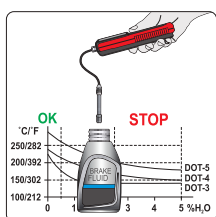

YATO
YT-72985 10/20

EN Brake line double flaring tool
PL Prasa ręczna do przewodów hamulcowych
DE Handpresse für Bremsleitungen
RU Ручной пресс для развальцовки тормозных труб
CZ Ruční list brzdového vedení
HU Kézi prés fékcsőhöz

RO Instrument de evazare dublă conducte frana
FR Presse à collet pour tuyaux de freins
IT Pressa manuale per tubi freno
ES Prensa manual para cables de freno
CN 铜管扩孔器



Ø 4.75, 6.35 mm

YATO
YT-06086 10

EN Brake fluid tester
PL Tester płynu hamulcowego
DE Bremsflüssigkeitstester
RU Тестер тормозной жидкости
CZ Tester stavu brzdové kapaliny
HU Fékolyadék tesztler

RO Tester lichid frana
FR Tester de liquide de frein
IT Tester del fluido frenante
ES Líquido de frenos tester
CN 刹车油检测器



YATO
YT-72982 12/72

EN Brake fluid tester
PL Tester płynu hamulcowego
DE Bremsflüssigkeitstester
RU Тестер тормозной жидкости
CZ Tester stavu brzdové kapaliny
HU Fékolyadék tesztler
RO Tester lichid frana
FR Tester de liquide de frein
IT Tester del fluido frenante
ES Líquido de frenos tester
CN 刹车油检测器



YATO
YT-72986 28

EN Brake retainer spring tool
 PL Ściągacz sprężynek szczepek hamulcowych
 DE Montagewerkzeug für Bremsfeder
 RU Съемник для тормозных пружин
 CZ Stahovač pružin brzdových čelistí
 HU Fékrugó szerelő szerszám
 RO Dispozitiv pt. montat arc pe sabot
 FR Extracteur de ressorts freins
 IT Freno scarpa di fissaggio a molla compressori
 ES Herramienta para resorte retenedor de frenos
 CN 鼓式刹车弹簧华司拆装器



YATO  **YT-0685**  12/96

EN Brake spring pliers kit
 PL Zestaw do montażu szczepek hamulcowych
 DE Bremsbacken-Montageset
 RU Набор инструментов для тормозных пружин
 CZ Sada na montáž brzdových čelistí
 HU Fogókészlet fékrugóhoz
 RO Dispozitiv pt. inlocuit garnituri cilindrii receptori
 FR Set pour le montage des mâchoires de freins
 IT Set per montaggio molle freni
 ES Juego para resortes de frenos
 CN 刹车拆卸工具组套

3 PCS 

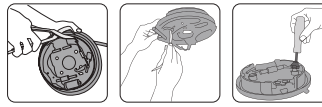

YATO  **YT-0684**  6/24

EN Brake spring pliers kit
 PL Zestaw do montażu szczepek hamulcowych
 DE Bremsbacken-montage Set
 RU Набор инструментов для тормозных пружин
 CZ Sada na montáž brzdových čelistí
 HU Fogókészlet fékrugóhoz
 RO Dispozitiv pt. inlocuit garnituri cilindrii receptori
 FR Set pour le montage des mâchoires de freins
 IT Set per montaggio molle freni
 ES Juego para resortes de frenos
 CN 刹车拆卸工具组套

8 PCS 



YATO  **YT-0680**  5

EN Universal brake tool set
 PL Zestaw do obsługi układów hamulcowych
 DE Bremsattel- Sprengringzange
 RU Набор для обслуживания тормозной системы
 CZ Sada pro údržbu brzdového systému
 HU Fékrendszer karbantartó készlet
 RO Set universal pt. frane
 FR Kit de maintenance et de montage
 IT Kit di manutenzione dell'impianto frenante
 ES Kit de mantenimiento del sistema de frenos
 CN 制动系统调整工具组套

15 PCS **1/2"** **3/8"** **CrV** 





YATO  **YT-06802**  4

EN Interior bent nose snap ring pliers
 PL Szczypce Segera do pierścieni zacisków hamulcowych
 DE Bremsattel- Sprengringzange
 RU Клещи зегера для тормозных суппортов
 CZ Kleště na pojslné kroužky brzdových svorek, segerovky
 HU Seeger-gyűrű fogó
 RO Cleste sigurante interior, indoit
 FR Pince seger pour bagues d'étrier de frein
 IT Pinza per anelli Seeger per freni
 ES Alicates Seeger para anillos de las pinzas de freno
 CN 挡圈钳

90° **190** mm **55** mm **BENT** **WYGIĘTE** 



YATO  **YT-06561** L [mm] **190**  5/20

EN Brake caliper press tool
 PL Separator do hamulców tarczowych
 DE Bremsattel-Presswerkzeug
 RU Распорка тормозных дисков
 CZ Přípravek na zatláčení brzdových pístků
 HU Fékmunkahenger visszanyomó
 RO Separator disc ambreiaj
 FR Séparateur des freins à disque
 IT Separatore per pistoncini freno
 ES Separador de frenos de discos
 CN 棘轮制动卡钳

40-68 mm **116x60** mm **1 2 4** 



YATO  **YT-06805**  20

EN Brake caliper press tool
PL Separator do hamulców tarczowych
DE Bremsattel-Presswerkzeug
RU Распорка тормозных дисков
CZ Přípravek na zatlačení brzdových pístků
HU Fékmunkahenger visszanyomó
RO Separator disc ambreiaj
FR Séparateur des freins à disque
IT Separatore per pistoncini freno
ES Separador de frenos de discos
CN 棘轮制动卡钳

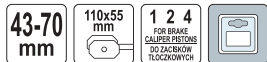

YATO

YT-0610



6/24

EN Disc brake spreader
PL Separator do hamulców tarczowych
DE Bremskolbenrücksteller
RU Распорка тормозных дисков
CZ Přípravek na zatlačení brzdových pístků
HU Fékmunkahenger visszanyomó
RO Separator disc ambreiaj
FR Séparateur des freins à disque
IT Separatore per pistoncini freno
ES Separador de frenos de discos
CN 刹车片分离器

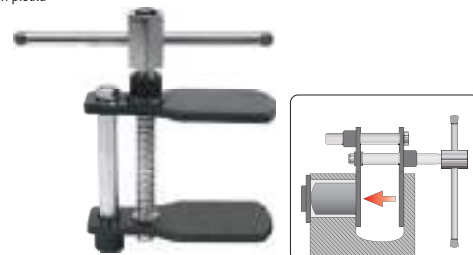
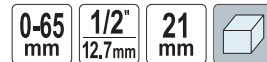

YATO

YT-0610



12/24

EN Disc brake piston tool
PL Uniwersalny klucz do wkręcania zacisków hamulcowych
DE Bremskolbenrücksteller universal
RU Ключ для тормозного поршня
CZ Univerzální klíč k montáži brzdových třmenů
HU Féknyereg összesnyomó
RO Dispozitiv pt. impins etrier
FR Clé universelle pour pinces de frein
IT Attrezzo per l'arretamento della pinza dei freni
ES Llave para comprimir pistones del freno de disco
CN 刹车分泵拆装器



CrV



General Motors, Ford, Chrysler, VW, Fiat

YATO

YT-0683



12/96

EN Brake caliper piston rewind wind back adaptors
PL Zestaw adapterów regulowanych do zacisków hamulcowych
DE Verstellbarer Adaptersatz für Bremssattel
RU Набор регулируемых адаптеров для тормозных суппортов
CZ Sada nastavitelných adaptérů pro brzdové třmeny
HU Állítható féknyereg adapter készlet
RO Adaptor pt. piston etrier frână
FR Kit adaptateurs ajustables pour pinces de frein
IT Kit di adattatori regolabili per pinze di freni
ES Juego de adaptadores ajustables para pinzas de freno
CN 可调节分泵调整器

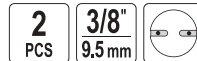

YATO

YT-06809



10/50

EN Brake socket bit set
PL Zestaw nasadek do zacisków hamulcowych
DE Steckschlüssel-Set für Bremssattel
RU Набор насадок для тормозных суппортов
CZ Sada násadek k čištění brzdových třmenů
HU Dugókulcs készlet féknyereg szereléshez
RO Set chei tubulare pt. saboti frana
FR Jeux de douilles pour les étriers de frein
IT Kit di attacchi per pinze di freni
ES Set de vasos para pinzas de freno
CN 刹车制动器套筒组套



YATO

YT-06807



10/20

EN Brake socket bit set
PL Zestaw nasadek do zacisków hamulcowych
DE Steckschlüssel-Set für Bremssattel
RU Набор насадок для тормозных суппортов
CZ Sada násadek k čištění brzdových třmenů
HU Dugókulcs készlet féknyereg szereléshez
RO Set chei tubulare pt. saboti frana
FR Jeux de douilles pour les étriers de frein
IT Kit di attacchi per pinze di freni
ES Set de vasos para pinzas de freno
CN 刹车制动器套筒组套

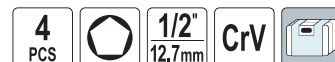

12, 14, 19 mm;
1/2" (12.5 mm); 10 mm; CrV

YATO

YT-06806



20

EN Brake socket bit set
PL Zestaw nasadek do zacisków hamulcowych
DE Steckschlüssel-Set für Bremssattel
RU Набор насадок для тормозных суппортов
CZ Sada násadek k čištění brzdových třmenů
HU Dugókulcs készlet féknyereg szereléshez
RO Set chei tubulare pt. saboti frana
FR Jeux de douilles pour les étriers de frein
IT Kit di attacchi per pinze di freni
ES Set de vasos para pinzas de freno
CN 刹车制动器套筒组套

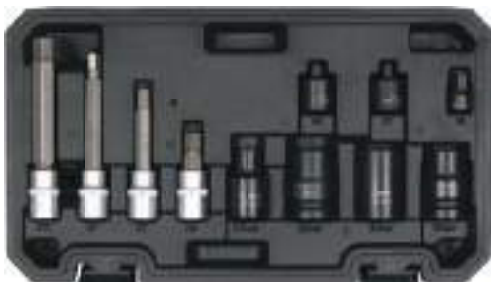

BMW, Mercedes, VAG

1/2" (12.7 mm): 11.5, 15, 20 mm (10 points/wpustów); 22 mm (7 points/wpustów); CrMo;

3/8" (9.5 mm): 7, 8, 9 mm; CrMo;

3/8" (9.5 mm): 7x72, 7x92, 9x50, 11x100 mm; AISI S2 / CrV

YATO

YT-06808



10

EN Brake cliper socket set
PL Zestaw narzędzi do zacisków hamulcowych
DE Bremssattel Werkzeug Satz
RU Набор специальных головок и бит для тормозных суппортов
CZ Sada nářadí pro brzdové čelisti
HU Féknyereg szerelő készlet
RO Set chei etrier de frana
FR Jeu d'outils pour étrier de frein
IT Kit di strumenti per pinze dei freni
ES Juego de herramientas para pinzas de freno
CN 刹车卡钳套筒工具组套



1/2" (12.7 mm): 14, 19 mm (5 points / wpustów); 14, 22 mm (7 points / wpustów); 11.5, 15, 20 mm (10 points / wpustów); CrV;
1/2" (12.7 mm): 14, 17, 19 mm (L=45 mm); 7, 9, 11 mm (L=78 mm); CrMo;
1/2" (12.7 mm): M14; (L=45 mm); M18 (L=78 mm); CrMo;
1/2" (12.7 mm): 14 mm (10 points / wpustów; L=78 mm); CrMo

YATO

YT-06811



5

- EN Disc brake pad & caliper service tool kit
- PL Zestaw ręcznych separatorów do zacisków hamulcowych
- DE Werkzeugsatz von manuellen Separatoren für Bremsklappen
- RU Набор ручных сепараторов для тормозных зажимов
- CZ Ruční sada na montáž kotoučových brzd
- HU Fékmunkahenger prés készlet
- RO Set de separatoare manuale pt. etrier frâna
- FR Set de repousse piston de frein
- IT Kit universale regolazione manuale per pistoni freni
- ES Juego de separadores manuales para abrazaderas de freno
- CN 刹车片分离器组套

11
PCS

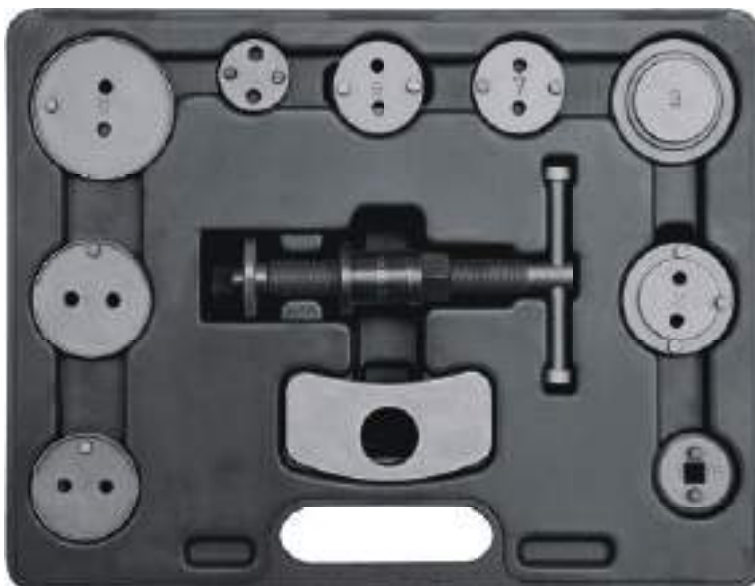
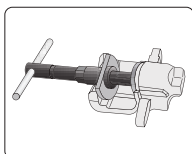

No.	zacisk przedni / front	zacisk tylny / rear
1-1		silownik
1		plytka oporowa
5		adapter z gniazdem
2		Citroen: XM, Xantia
3	Alfa Romeo, Audi, Austin, BMW, Honda, Jaguar, MB, Mitsubishi, Nissan, Rover, Toyota, VW	
4		Ford, Mazda, Subaru, Alfa Romeo, Saab
6		Nissan
7		Audi, Ford, Honda, Nissan, Rover, Saab, Subaru, VW
8	General Motors	
9	General Motors	

YATO

YT-0681



5

- EN Disc brake pad & caliper service tool kit
- PL Zestaw ręcznych separatorów do zacisków hamulcowych
- DE Werkzeugsatz von manuellen Separatoren für Bremsklappen
- RU Набор ручных сепараторов для тормозных зажимов
- CZ Ruční sada na montáž kotoučových brzd
- HU Fékmunkahenger prés készlet
- RO Set de separatoare manuale pt. etrier frâna
- FR Set de repousse piston de frein
- IT Kit universale regolazione manuale per pistoni freni
- ES Juego de separadores manuales para abrazaderas de freno
- CN 制动钳活塞工具组套

12
PCS

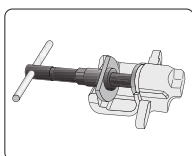

Nr krążka	zacisk przedni / front	zacisk tylny / rear
0	General Motors - zaciski 2 1/2"	
1	adapter do przedniego zacisku	
2		Citroen XM, Xantia
3		Opel
4		Ford, Mazda, Saab, Alfa Romeo 164 2.0, Honda, General Motors
5		Nissan Maxima
6		Nissan Primera, VW Golf IV
7	Audi, Rover, Subaru, Ford, Nissan, Peugeot, Toyota, VW	
8	General Motors - zaciski 1 7/8"	
9	General Motors - zaciski 2 1/8"	
11		Adapter do tylnego zacisku

YATO

YT-0611



5

- EN Pneumatic brake caliper rewind tool kit
- PL Pneumatyczny zestaw do zacisków hamulcowych
- DE Pneumatik-Bremskolben-Rückstellsatz
- RU Пневматический набор к тормозным зажимам
- CZ Pneumatická sada k montáži kotoučových brzd
- HU Pneumatikus fékmunkahenger visszanyomó készlet
- RO Ansamblu pneumatic pt. cilindre de frână
- FR Set pneumatique aux séparateurs de pinces de frein
- IT Set arretratore pneumatico per pistoncini freni
- ES Juego de herramientas neumáticas para pistones de freno
- CN 气动刹车分别调整器

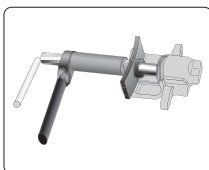

16
PCS

0.75
MPa

STANDARD

No.	zacisk przedni / front	zacisk tylny / rear
0	General Motors - zaciski 2 1/2" (12,5 mm)	
2	Citroen XM, Xantia	
3	Audi, Alfa Romeo, Fiat, Ford Fiesta, Isuzu, Honda Concerto, Jaguar (F/R), BMW, Mercedes - Benz, Mitsubishi Colt, Nissan: Almera, Stanza, Sunny, Rover, Toyota Camry, Volvo, VW: Passat, Golf GTI	
4	Ford, Mazda, Saab, Alfa Romeo 164 2.0, Honda, General Motors	
5	adapter z gniazdem 3/8" (10 mm)	
6	Nissan Primera, VW Golf IV	
7	Audi, Rover, Subaru, Ford, Nissan, Peugeot, Toyota, VW	
8	General Motors - zaciski 1 7/8" (47,6 mm)	
9	General Motors - zaciski 2 1/8" (54 mm)	
A		Renault
E	Nissan Maxima	
F		Opel
K		Citroen
M		Ford, Cooper
N	Saab, Honda	

YATO
YT-0671

5

- EN Disc brake pad & caliper service tool kit
- PL Zestaw ręcznych separatorów do zacisków hamulcowych
- DE Werkzeugsatz von manuellen Separatoren für Bremsklappen
- RU Набор ручных сепараторов для тормозных зажимов
- CZ Ruční sada na montáž kotoučových brzd
- HU Fékmunkahenger prés készlet
- RO Set de separatoare manuale pt. etrier frâna
- FR Set de repousse piston de frein
- IT Kit universale regolazione manuale per pistoncini freni
- ES Juego de separadores manuales para abrazaderas de freno
- CN 刹车片分离器组套

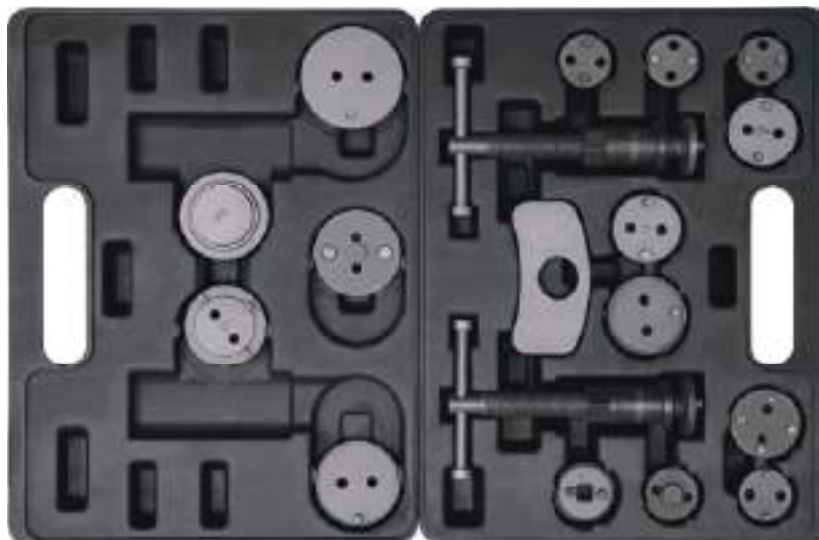
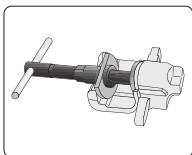
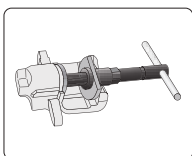

18
PCS

No.	zacisk przedni / front	zacisk tylny / rear
1-1	silowniki z lewym i prawym gwintem	
1	plytka oporowa	
5	3/8"	adapter z gniazdem
0	2 1/2"	General Motors
2	2 1/64"	Citroen XM, Xantia
3	2 5/32"	Audi, Alfa Romeo, Fiat, Ford Fiesta, Honda, Jaguar, BMW, Mercedes, Mitsubishi Colt, Nissan, Rover, Austin, Toyota Camry, Volvo, VW: Passat, Golf GTI
4	1 1/4"	Jaguar
6	1 21/32"	Ford, Mazda, Saab, Alfa Romeo 164 2.0, Honda, General Motors
7	1 21/32"	Nissan Primera, VW Golf IV
8	1 7/8"	Audi, Rover, Subaru, Ford, Nissan, Peugeot, Toyota, VW
9	2 1/8"	General Motors, Cadillac
E	1 21/32"	Nissan Maxima
F	1 1/4"	Opel
K	2 1/8"	Citroen
M	1 1/4"	Ford
N	1 1/4"	Saab, Honda
A	1 3/16"	Renault

YATO
YT-0682

5

- EN Disc brake pad & caliper service tool kit
- PL Zestaw ręcznych separatorów do zacisków hamulcowych
- DE Werkzeugsatz von manuellen Separatoren für Bremsklammern
- RU Набор ручных сепараторов для тормозных зажимов
- CZ Ruční sada na montáž kotoučových brzd
- HU Fékmunkahenger prés készlet
- RO Set de separatoare manuale pt. etrier frâna
- FR Set de repousse piston de frein
- IT Kit universale regolazione manuale per pistoni freni
- ES Juego de separadores manuales para abrazaderas de freno
- CN 碟式分泵刹车调整器组套 35件



35
PCS

3/8"
9.5 mm

No.	zaczisk przedni / front	zaczisk tylny / rear
2	2 1/64" (51,0 mm)	Citroen Xantia, Honda Prelude
3	2 5/32" (55,0 mm)	Fiat, Alfa Romeo, Isuzu, Mercedes Benz, BMW, Citroen, Ford, Honda, Jaguar, Nissan, Peugeot, Rover, Toyota, VAG, Volvo
4	1 1/4" (32,0 mm)	Jaguar
5	3/8" (10,0 mm)	Ford, Mazda, Saab, Fiat, Alfa Romeo, General Motors
7	1 21/32" (42,0 mm)	adapter z gniazdem
6	1 21/32" (42,0 mm)	Nissan, VAG, Jaguar S
8	1 7/8" (48,0 mm)	Audi, Rover, Subaru, Ford, Nissan, Peugeot, Toyota, VAG, Saab, Jaguar, GM
9	2 1/8" (54,0 mm)	General Motors
0	2 1/2" (63,5 mm)	General Motors, Cadillac
A	1 1/5" (30,5 mm)	General Motors
B	1 19/30" (41,5 mm)	Renault, BMW, Mini
C	1 19/30" (41,5 mm)	Ford, Lincoln, Subaru
D	2 1/64" (51,0 mm)	Mini, Nissan, Opel, Toyota
E	1 21/32" (42,0 mm)	Renault, Citroen
F	1 1/4" (32,0 mm)	Nissan Maxima
G	3/8" (10,0 mm)	Opel, Fiat
J	1 22/33" (42,5 mm)	Peugeot, GM
K	2 1/8" (54,0 mm)	Fiat, Alfa Romeo, Audi, Citroen, Renault, Peugeot, Ford, Nissan, Saab, VAG, Subaru, Volvo
K1	2 1/8" (54,0 mm)	Citroen, Opel
K2	1 22/33" (42,5 mm)	Citroen, Renault, Audi
P	1 19/30" (41,5 mm)	VAG, BMW, Ford, Lancia, Proton, Renault, Rover, Citroen
M	1 1/4" (32,0 mm)	Ford, Mini, Nissan
N	1 1/4" (32,0 mm)	Saab, Honda, Alfa Romeo, Ford Mondeo, Lancia, Volkswagen
Z	1 3/16" (30,0 mm)	Ford, Mazda, Mitsubishi, Toyota Corolla
1, 11, 12	plytka опорowa	

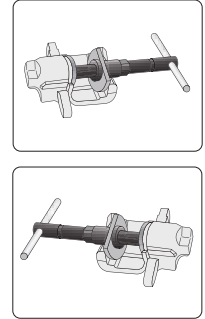

YATO

YT-06822 5

- EN Brake disc run out kit
- PL Zestaw do pomiaru bicia tarcz hamulcowych
- DE Set zum Prüfen des Bremschlags von Brems Scheiben
- RU Набор для измерения биения тормозного диска
- CZ Sada pro měření vibrací brzdových kotoučů
- HU Féktárcsa oldalútés mérő készlet
- RO Set pt. masurat uzura discurilor de frana
- FR Kit de mesure pour disque de frein
- IT Misuratore di spessore del disco del freno
- ES Set para medir el desgaste de los discos de freno
- CN 制动盘跳动检测仪

3
PCS

+/-
0.01
mm



YATO

YT-72970 6

- EN Wheel hub grinder
- PL Szczotka do czyszczenia piast
- DE Radnabenschleifer
- RU Щетка для чистки ступицы колеса
- CZ Kartáč na čištění nábojů kol
- HU Kerékagy tisztító tárcsa
- RO Perie pt. curățare butuc
- FR Brosse abrasive pour le nettoyage des moyeux
- IT Pulitore per mozzu ruote
- ES Cepillo abrasivo para limpieza de bujes
- CN 轮毂抛光盘

1/2"
12.7 mm

150
mm

FOR IMPACT TOOLS DO NARZEDZI UDAROWYCH

SILICON CARBIDE WĘGLIK KRZEMU



YATO

YT-25380 45

- EN Spare pad for wheel hub grinder
- PL Ściernica wymienna do szczotki do czyszczenia piast
- DE Ersatzscheibe für Radnabenschleifer
- RU Сменная щетка для чистки ступицы колеса
- CZ Kotouč náhradní na čištění nábojů kol
- HU Cserélhető tisztítókorong
- RO Rezerva pt. butuc roata polizat
- FR Meule de rechange pour brosse de nettoyage des moyeux
- IT Mola di ricambio per pulitore per mozzu ruote
- ES Disco recambio para limpieza de bujes
- CN 备用抛光盘

150
mm

FOR IMPACT TOOLS DO NARZEDZI UDAROWYCH

SILICON CARBIDE WĘGLIK KRZEMU



For YT-25380
Dla YT-25380

YATO

YT-25383 60/120

- EN Stud hub cleaner set
- PL Zestaw do czyszczenia piast i szpilek
- DE Stehbolzen-Radnabenschleifer-Satz
- RU Набор насадок для чистки болтов ступицы
- CZ Sada na čištění nábojů a čepů kol
- HU Kerékagy és tű tisztító készlet
- RO Set de curățare butuci de știfturi
- FR Kit de nettoyage pour moyeux et axes
- IT Kit di pulizia dei mozzu della ruota e spille
- ES Juego de limpieza de bujes
- CN 轮毂抛光盘

14
PCS

1/2"
12.7 mm

FOR IMPACT TOOLS DO NARZEDZI UDAROWYCH

HEAVY DUTY NYLON WZMOCNIONNY NYLON



YATO

YT-25384 10/40

EN Dial indicator
PL Czujnik zegarowy
DE Messuhr
RU Индикатор часового типа
CZ Analogový senzor
HU Óramutató érzékelő
RO Indicator testare cu cadran
FR Indicateur à cadran
IT Indicatore a quadrante
ES Indicador de cuadrante
CN 百分表



0-10 mm
+/- 0.01 mm
55 mm
8 mm
1x + LR44

EN Electronic dial indicator
PL Czujnik zegarowy elektroniczny
DE Elektronische Messuhr
RU Электронный индикатор часового типа
CZ Elektronický senzor
HU Elektromos órá érzékelő
RO Indicator testare electronic
FR Indicateur à cadran électronique
IT Indicatore quadrante elettronico
ES Indicador de cuadrante electrónico
CN 数显百分表



0-12.7 mm
+/- 0.01 mm
57 mm
8 mm
1x + LR44

EN Magnetic indicator stand
PL Statyw magnetyczny
DE Magnetständer
RU Магнитный штатив
CZ Magnetický stativ
HU Mágneses állvány
RO Stand magnetic cu indicator
FR Trépied magnétique
IT Supporto magnetico
ES Soporte magnético
CN 磁性表座



50x65 x55mm
BASE / BAZA
max 70 kg

For YT-72450, YT-72453
Dla YT-72450, YT-72453

YATO	Measuring range / Zakres pomiaru [mm]	
YT-72450	0-10	50

YATO	Measuring range / Zakres pomiaru [mm]	
YT-72453	0-12.7	50

YATO		
YT-72460		10

EN ABS and brake pressure gauge
PL Tester ciśnienia w układzie hamulcowym i ABS
DE Bremsdruck- und ABS-Tester
RU Тестер давления в тормозной системе и ABS
CZ Tester tlaku v brzdovém systému a ABS
HU ABS- és fék nyomásmérő készülék
RO Manometru pt. presiune frane si ABS
FR Testeur de pression de freinage et d'ABS
IT Misuratore pressione del sistema frenante e ABS
ES Probador de presión en el sistema de frenos y ABS
CN ABS刹车压力表



Included: pressure gauges: 0-200 kg/cm², 0-20.6 MPa (2 PCS); adaptors: #1: 7/16, M10x1.5 mm (2 PCS); #2: 7/16, M10x1 mm (2 PCS); #3: 7/16, M7x1 mm (2 PCS); #4: 7/16, M8x1.25 mm (2 PCS); #5: Ø9.34, G3/8, 24T (2 PCS); #6: Ø6.1, G1/4, 28T (2 PCS); #7: Ø10.9, 7/16, 24T (2 PCS); #8: Ø10.9, 7/16, 20T (2 PCS); #9: Ø7.64, 7/16, 24T (2 PCS); #10: M8x1 mm (2 PCS); #11: M10x1 mm (2 PCS); #12: M10x1.25 mm (2 PCS); #13: M6x1 mm (2 PCS); #A: 7/16, M10x1 mm; #B: 7/16, M10x1 mm; #C: Ø9.34, 24T; #D: M12x1 mm; #E: M11x1.5 mm; #F: Ø13, M13x1.5 mm; #G: Ø12.6, 20T; #H: Ø14, 20T; #I: Ø10.9, 24T; #J: Ø14, 18T; #K: M10x1.25; connectors: 90° (2 PCS); 45° (2 PCS); connecting pipe; connecting pipe M8x1.0 mm; angle connecting pipe M4x1.5 mm
W zestawie: manometry: 0-200 kg/cm², 0-20.6 MPa (2 szt.); adaptery: #1: 7/16, M10x1.5 mm (2 szt.); #2: 7/16, M10x1 mm (2 szt.); #3: 7/16, M7x1 mm (2 szt.); #4: 7/16, M8x1.25 mm (2 szt.); #5: Ø9.34, G3/8, 24T (2 szt.); #6: Ø6.1, G1/4, 28T (2 szt.); #7: Ø10.9, 7/16, 24T (2 szt.); #8: Ø10.9, 7/16, 20T (2 szt.); #9: Ø7.64, 7/16, 24T (2 szt.); #10: M8x1 mm (2 szt.); #11: M10x1 mm (2 szt.); #12: M10x1.25 mm (2 szt.); #13: M6x1 mm (2 szt.); #A: 7/16, M10x1 mm; #B: 7/16, M10x1 mm; #C: Ø9.34, 24T; #D: M12x1 mm; #E: M11x1.5 mm; #F: Ø13, M13x1.5 mm; #G: Ø12.6, 20T; #H: Ø14, 20T; #I: Ø10.9, 24T; #J: Ø14, 18T; #K: M10x1.25; złącza: 90° (2 szt.); 45° (2 szt.); rurka łącząca; rurka łącząca M8x1.0 mm; kątowna rurka łącząca M4x1.5 mm

46 PCS
20.6 MPa (max.)
FOR BRAKING SYSTEMS DO UKŁADU HAMULCOWYCH

YATO		
YT-73040		5

EN Power steering tester kit
PL Zestaw diagnostyczny do wspomagania układu kierowniczego
DE Diagnoseset für Servolenkung
RU Диагностический комплект для гидроусилителя руля
CZ Sada pro diagnostiku systému posilovače řízení
HU Szervó-kormánymű nyomásmérő készlet

RO Kit tester servodirectie
FR Kit contrôle direction assistée
IT Kit di diagnostica del servosterzo
ES Kit de diagnóstico para dirección asistida
CN 转向机油压力表

15 PCS
14 MPa (max.)
FOR POWER STEERING SYSTEM DO UKŁADU KIEROWNICZEGO



Included: pressure gauge 140 bar / 2000 PSI; flexible hose 250 mm 1/8" NPT x M11 x 1.25; adapters: 1/8" NPT x M16 x 1.5 (2 PCS); 1/8" NPT x M18 x 1.5, 1/8" NPT x M11 x 1.0, M11 x 1.0 x M11 x 1.25, M11 x 1.25 x M18 x 1.5, M11 x 1.25 x M16 x 1.5 (2 PCS); M16 x 1.5 x M11 x 1.25, 1/8" NPT x M16 x 1.5, M11 x 1.25 x 1/8" NPT, 1/8" NPT x M16 x 1.5, M11 x 1.25 x M16 x 1.5
W zestawie: manometr 140 bar / 2000 PSI; elastyczny wąż 250 mm 1/8" NPT x M11 x 1.25; adaptery: 1/8" NPT x M16 x 1.5 (2 PCS); 1/8" NPT x M18 x 1.5, 1/8" NPT x M11 x 1.0, M11 x 1.0 x M11 x 1.25, M11 x 1.25 x M18 x 1.5, M11 x 1.25 x M16 x 1.5 (2 PCS); M16 x 1.5 x M11 x 1.25, 1/8" NPT x M16 x 1.5, M11 x 1.25 x 1/8" NPT, 1/8" NPT x M16 x 1.5, M11 x 1.25 x M16 x 1.5

YATO		
YT-73045		10

EN Universal hydraulic flaring tool set
PL Prasa hydrauliczna do przewodów hamulcowych i klimatyzacji
DE Hydraulisches Bördelgerät für Bremsleitungen
RU Гидравлический пресс для тормозных проводов и кондиционера
CZ Hydraulický lis pro výrobu brzdového vedení
HU Hidraulikus fék- és légkondicionáló cső peremező készlet
RO Kit hidraulic universal pt. evazare
FR Presse à collet hydraulique pour tuyaux de frein et de climatisation
IT Pressa idraulica per tubi freno e per aria condizionata
ES Kit de abocardador hidráulico para tubos de freno y de aire acondicionado
CN 制动管子扩孔器

14 PCS
Cu
BRASS MOSIĄDZ
AL
STEEL STAL



Flare forming tools / Końcówki do spęczania:
OP1: 4.75 mm (3/16"), 5 mm, 6.35 mm (1/4")
DIN: 4.75 mm, 5 mm
OP2: 4.75 mm (3/16"), 5 mm, 6.35 mm (1/4")
DIN: 4.75 mm, 5 mm

YATO		
YT-06088		5

EN Air brake bleeder
 PL Urządzenie pneumatyczne do wymiany płynu hamulcowego
 DE Druckluft-Bremseentlüfter
 RU Устройство для замены тормозной жидкости
 CZ Sada na odvzdušnění brzdové soustavy a hydraulické spojky
 HU Pneumatikus eszköz a fékolyadék cseréjére
 RO Aparat de schimbăți lichidul frână
 FR Purger de frein et d'embrayage pneumatique
 IT Strumento per la sostituzione del liquido freni
 ES Sangrado del freno de aire comprimido
 CN 气动刹车油更换机



0.27 MPa
 5 L
 6 m
 STANDARD

EN Brake and clutch bleeder bleeding vacuum pump kit
 PL Zestaw pneumatyczny do odpowietrzania układu hamulcowego
 DE Pneumatischer Bremsen-Entlüftungs Satz
 RU Пневматический комплект для прокачки тормозной системы
 CZ Pneumatická sada pro odvzdušnění brzdového systému
 HU Pneumatikus fék légtelenítő készlet
 RO Kit pompa de vid pt. aerisire frana si ambreiaj
 FR Kit de purge d'air pour freins
 IT Kit pneumatico per lo spurgo dell'impianto frenante
 ES Kit neumático para purgar el sistema de freno
 CN 刹车油更换机



0.62 MPa
 1 L
 180 cm
 STANDARD

$L_{pa} = \leq 70$ dB; $L_{wa} = \leq 85$ dB; $a_n = \leq 2,5$ m/s²



YATO
 YT-06845 1

YATO
 YT-06835 20

EN Coil spring clamp
 PL Ściągacz do sprężyn
 DE Federspanner
 RU Съёмник пружин
 CZ Stahovák pružin tlumičů automobilů
 HU Rugóösszehúzó
 RO Presa pt. arcuri
 FR Compresseurs de ressort
 IT Estrattore per smonta molle

ES Extractor de muelles
 CN 弹簧夹



2 PCS
 1/2" 12.7mm
 21 mm

90x200 mm



82x370 mm CrV



COLD FORGED KUTE NA ZIMNO

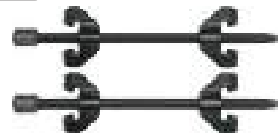

YATO
 YT-0605 90 [mm] 200 [mm] 5/10

YATO
 YT-2544 82 [mm] 370 [mm] 8

YATO
 YT-2546 82 [mm] 280 [mm] 8
 YT-2547 82 [mm] 355 [mm] 8

EN Coil spring compressor
 PL Ściągacz wewnętrzny do sprężyn
 DE Innenabzieher für Federn
 RU Внутренний съёмник для пружин
 CZ Vnitřní stahovák pružin
 HU Belső rugóösszehúzó
 RO Dispozitiv compresat arcuri
 FR Extracteur interne de ressorts
 IT Estrattore interno per molle
 ES Extractor para muelles interior
 CN 弹簧压缩机



20 mm
 145 mm
 300 mm
 DROP FORGED KUTE

EN Macpherson spring dumper extractor
 PL Ściągacz do sprężyn MacPhersona
 DE Abziehvorrichtung für Federn von MacPherson
 RU Съёмник пружин подвески Макферсона
 CZ Stahovák pružin McPherson
 HU MacPherson rugó összehúzó
 RO Extractor de arcuri MacPherson
 FR Compresseurs de ressort MacPherson
 IT Estrattore per molle MacPherson
 ES Desmontador para los resortes de MacPherson
 CN 弹簧压缩机



100-250 mm max 2900kg
 CrMo SCM415
 3 POINTS OF FORCE PUNTY MOCOVANJA

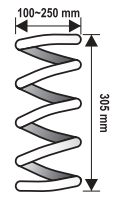

YATO
 YT-25472 145 [mm] 300 [mm] 6/12

YATO
 YT-2535 2

EN Interchangeable fork spring compressor and removal tool
 PL Ściągacz do sprężyn MacPhersona z wymiennymi uchwytami
 DE Abziehvorrichtung für MacPherson-Federn mit austauschbaren Halterungen
 RU Стяжка для снятия пружин Макферсона со сменными полукольцами
 CZ Stahovák pružin McPherson s vyměnitelnými čelistmi
 HU MacPherson rugó összehúzó cserélhető pófakkal
 RO Ancoră suspensie MacPherson cu mâner interschimbabile
 FR Compresseurs de ressort MacPherson
 IT Smonta ammortizzatori per sospensioni MacPherson
 ES Extractor de resortes MacPherson con mangos intercambiables
 CN 免拆式减震弹簧压缩机



7 PCS
 65-125 mm
 88-160 mm
 126-212 mm max 1500kg

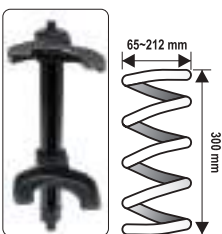

YATO
 YT-2536 1

EN Drive nut set
PL Zestaw nasadek do amortyzatorów
DE Stossdämpfer Nutmutter Einsätze
RU Набор головок для амортизаторов
CZ Sada hlavic na uložení tlumiče
HU Lengéscsaplaptökiszedő szet

RO Set prezoane
FR Set des embouts aux amortisseurs
IT Set di chiavi per aria condizionata
ES Juego de boquillas de amortiguadores
CN 拆装减震器套件组套



5
PCS

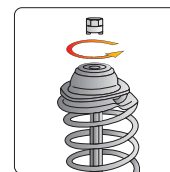

10.5 mm (VW Golf rear), 12.5 mm (VW Golf front), 14.5 mm (VW Polo, Golf, Passat, Audi 80), 14.5 mm (Austin Maestro), 14.0 mm (Mercedes-Benz C-Class (W203))

YATO

Size / Rozmiar [mm]

YT-0621

10.5, 12.5, 14.5, 14.5, 14

12/48

EN Turnbuckle for shock absorber's top lid
PL Zestaw kluczy do mocowania amortyzatorów
DE Schlüsselset zum Befestigen der Stoßdämpfer
RU Набор ключей для крепления амортизаторов
CZ Sada klíčů k montáži tlumičů
HU Kulcskészlet lengéscsaplaptök rögzítéséhez
RO Set chei pt. fixare amortizoare
FR Set de clés pour amortisseurs
IT Set chiavi per montare ammortizzatori
ES Juego de llaves para la instalación de amortiguadores
CN 避震器拆卸器



39
PCS

CrMo
SCM415

CrV
6140

CrV
50BV30

8660
HIGH SPEED STEEL
ENL. W/30%Ni2Al2N

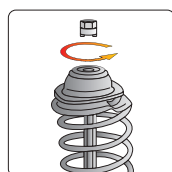

	size / rozmiar	type of car / model samochodu		size / rozmiar	type of car / model samochodu
<p>CrMo SCM415</p>	10.5 x 3.5 mm	VW Golf Rear Axle	<p>CrV 6140</p>	D5	Nissan
	12.5 x 3.5 mm	VW Golf Front Axle		D10	Nissan, Ford
	14.5 x 5 mm	VW Polo, Golf, Passat, Audi 80		8 mm	Mercedes-Benz
	14.5 x 3 mm	Austin Maestro		9 mm	Opel/Vauxhall, Chrysler
	14 x 2.5 mm	Mercedenz Benz W203 (C-class), W209 (CLK)		10 mm	Chrysler, Ford
<p>CrV 50BV30</p>	14 mm	Honda, Nissan	<p>STEEL 8660</p>	11 mm	Japanese Cars
	16 mm	VW, Audi, Seat, Fiat		5 mm	Honda
	17 mm	Ford, VW, Audi, Seat, Fiat		6 mm	Seat, Fiat, Citroen, Peugeot, Ford, Opel, Renault, Japanese Cars, BMW
	18 mm	Ford, VW, Audi, Seat, Rover, Fiat, Opel, Peugeot, Renault, Japanese Cars		7 mm	VW, Audi, Seat, Fiat, Citroen, Peugeot, Toyota, Mercedes-Benz (W203), Renault
	19 mm	VW, Audi, Seat, Citroen, Fiat, Opel, Peugeot, Toyota		8 mm	Mercedes-Benz
	21 mm	Mercedenz-Benz W203, Chrysler, VW, Audi, Ford, Japanese Cars		3 mm	Mercedes-Benz, Opel, Renault
	22 mm	VW, Audi, Seat, Citroen, Fiat, Opel, Peugeot, Renault, BMW		3.5 mm	Chrysler, Ford, Citroen, Peugeot
	24 mm	Volvo		4 mm	Citroen, Peugeot
	27 mm	VW, Audi, Citroen, Peugeot		M12	Opel/Vauxhall
	<p>CrV 6140</p>	4 mm		Nissan	<p>STEEL 8660</p>
5.2 mm		VW, Audi, Nissan	T60	Ford	
6 mm		VW, Audi, Renault			
6.3 mm		Nissan			
7 mm		VW, Audi, Seat, Fiat			
8 mm		Seat, Fiat			
9 mm		Japanese Cars			
10 mm		Seat, Fiat, Volvo			
12 mm	Seat, Fiat				

YATO

YT-0628

3

EN Tire valve stem inserter
PL Przeciagacz do zaworków gumowych
DE Abziehvorrichtung für Gummiventile
RU Протяжка к резиновым клапанам

CZ Páka k provlékání bezdušových ventilů
HU Szifjeszesség mérő
RO Broșă pt. supapele cauciucate
FR Levier tire-valve

IT Brocca valvola di gomma
ES Brocha de tracción para las válvulas de goma
CN 气门插入工具

290
mm

RUBBER
VALVES
ZAWORKY
GUMOWE



YATO

YT-0619

L [mm]

290

12/72

EN Wheel balance pliers
 PL Szczypce do wyważania kół
 DE Auswuchtgewicht-Zange
 RU Клеши для балансировки колес
 CZ Kleště pro vyvažování kol
 HU Centrifúrály szerelő szerszám
 RO Clește pt. cauciuc
 FR Pincès pour le contrepois à agrafe de roue de voiture
 IT Pinze per equilibrio ruota
 ES Tenazas de equilibrar ruedas
 CN 平衡钳

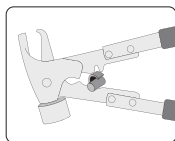
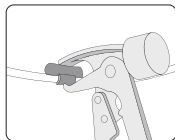
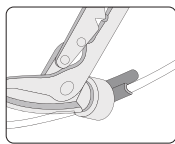



YATO  
 YT-0643 12/48

EN Deep aluminium wheel nut socket set
 PL Zestaw nasadek udarowych długich do felg aluminiowych
 DE Alu-Felgen Kraft-Stecknüsse, lang
 RU Набор длинных ударных насадок для алюминиевых дисков
 CZ Sada dlouhých nárazových zásuvek pro hliníkové disky
 HU Hosszított dugókulcs készlet, könnyűfém felnikhez
 RO Set chei adanci pt. plite aluminiu
 FR Jeu de douilles à chocs longues pour jantes en aluminium
 IT Kit di punte a percussione lunghe per cerchi in lega
 ES Juego de vasos de impacto largos para llantas de aluminio
 CN 加长轮胎保护套筒

6 PCS
 1/2" 12.7mm
 150 mm
 17 19 21 mm
 27 29 31 mm
CrMo
 AS-DRIVE 





 17, 19, 21 mm
YATO  
 YT-10563 1/2" (12.7 mm) 10

EN Emergency wheel nut remover
 PL Nasadki udarowe do wykręcania śrub zabezpieczających
 DE Schlag-Steckschlüsselsatz für Radsicherungsschrauben
 RU Ударные головки для снятия предохранительных винтов
 CZ Sada nástrčných hlavíc pro demontáž bezpečnostních šroubů
 HU Útve-dugókulcs készlet biztonsági csavarok kihajtásához
 RO Set tubulare speciale pt. prezoane rotunjite
 FR Jeu d'outils d'impact pour le dévissage des vis de sécurité
 IT Chiavi ad impatto per estrazione viti di sicurezza
 ES Vasos de impacto para desenroscar tornillos de seguridad
 CN 应急螺母组套

4 PCS
 1/2" 12.7mm
 17-26 mm
CrMo





 17, 18.5, 21.5, 26 mm; CrMo
YATO  
 YT-06030 1/2" (12.7 mm) 10/20

EN Deep thin wall impact sockets
 PL Zestaw nasadek udarowych do felg aluminiowych
 DE Alu-Felgen Kraft-Stecknüsse
 RU Набор головок для алюминиевых дисков
 CZ Sada nástrčných klíčů na alu ráfky
 HU Hosszított dugókulcs készlet, könnyűfém felnikhez
 RO Set chei adanci pt. plite aluminiu
 FR Set de douilles profondes à choc
 IT Set di chiavi a bussola per dadi ruota di alluminio
 ES Juego de boquillas de percusión para llantas de aluminio
 CN 风动薄壁长套筒

3 PCS
 1/2" 12.7mm
 17 19 21 mm
 26 29 31 mm
AS-DRIVE **CrMo** SCM440 



- For service station and tire workshops
- For maximum impact loads
- Drive locks
- Ultra thin walls and nylon cover for working with alu rims
- Anodised colour finish for fast identification of size
- Dla serwisów i warsztatów oponiarskich
- Do największych obciążeń udarowych i tętniących
- Zamki blokujące
- Ultracienkie ścianki i nylonowe pokrycie do pracy z felgami aluminiowymi
- Anodowane, kolorowe wykończenie dla szybkiej identyfikacji rozmiaru

 17, 19, 21 mm

YATO  
 YT-1056 1/2" (12.7 mm) 12/24

EN Deep thin wall impact sockets
 PL Zestaw nasadek udarowych do felg aluminiowych
 DE Alu-Felgen Kraft-Stecknüsse
 RU Набор головок для алюминиевых дисков
 CZ Sada nástrčných klíčů na alu ráfky
 HU Hosszított dugókulcs készlet, könnyűfém felnikhez
 RO Dibu de impact cu mufare in interior
 FR Set de douilles profondes à choc
 IT Set di chiavi a bussola per dadi ruota di alluminio
 ES Juego de boquillas de percusión para llantas de aluminio
 CN 风动薄壁长套筒

10 PCS
 1/2" 12.7mm
CrMo
AS-DRIVE 



- 15, 17, 19, 21, 22, 23, 24 mm; 7/8";
- 17 mm (Mercedes); 21 mm (Kia, Hyundai)

YATO  
 YT-10564 1/2" (12.7 mm) 5

EN Wheel lock lug nut removal set
 PL Zestaw nasadek do wykręcania śrub zabezpieczających
 DE Steckschlüsselsatz für Radsicherungsschrauben
 RU Набор головок для снятия предохранительных винтов
 CZ Sada hlavíc pro demontáž bezpečnostních šroubů
 HU Dugókulcs készlet biztonsági csavarok kihajtásához
 RO Set de demontare a piulitelor de blocare a rotijlor
 FR Jeu d'outils pour le dévissage des vis de sécurité
 IT Set di bussole per svitare bulloni di sicurezza
 ES Juego de vasos para destornillar tornillos de seguridad
 CN 弹簧锁拆卸套筒

10 PCS
 18-25 mm
CrMo 



- 18, 19, 20, 21, 22, 23, 24, 25 mm; CrMo;
- 17x180 mm, 22x180 mm

YATO  
 YT-060302 5

EN Steering and suspension indicator
PL Przyrząd do sprawdzania luzów zawieszenia
DE Vorrichtung zur Kontrolle des Aufhängungsspiels
RU Инструмент для проверки люфта подвески
CZ Zařízení pro kontrolu vůle zavěšení
HU Futómű lazulás ellenőrző
RO Indicator de direcție și suspensie
FR Dispositif de contrôle du jeu de la suspension
IT Strumento per il controllo giochi delle sospensioni
ES Equipo para comprobar juegos en la suspensión
CN 底盘间隙测试工具

1/2"
12.7mm
50 mm
390 mm



YATO		
YT-17490	1/2" (12.7 mm)	20

EN Folding cross wrench
PL Składany klucz do kół w etui
DE Radmutternschlüssel
RU Балонный крестовой разборный ключ с чехлом
CZ Skládací křížový klíč na maticе
HU Összecsukható kereszt csavar kulcs
RO Cheie cruce pt. șuruburi roți
FR Clé démonte roue en croix démontable
IT Pierevole cress chiave
ES llave para las ruedas de automóviles
CN 可折叠十字扳手

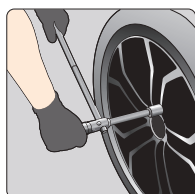

4 PCS
1/2"
12.7mm
CrV
ETUI FUTERAL



1/2" (12.7 mm): 17, 19, 21, 23 mm

YATO		
YT-08035	1/2" (12.7 mm)	10

EN Folding cross wrench
PL Składany klucz do kół
DE Klappbarer Radschlüssel
RU Складной ключ для колес
CZ Skládací klíč na kola
HU Összecsukható kerékkulcs

RO Cheie in cruce plianta
FR Clé à roue pliante
IT Chiave per ruote pieghevole
ES Llave de rueda plegable
CN 可折叠十字扳手

4 PCS
1/2"
12.7mm
CrV



1/2" (12.7 mm): 17, 19, 21, 23 mm

YATO		
YT-08033	1/2" (12.7 mm)	5/10

EN Cross rim wrench
PL Krzyżakowy klucz do kół
DE Kreuzschlüssel
RU Ключ-крест балонный
CZ Klíč na kola křížový
HU Kereszt kerékkulcs



CrV

YATO	Size / Rozmiar [mm]	
YT-0800	17x19x21x22	10
YT-0801	17x19x21x1/2" (12.7 mm)	10
YT-0802	24x27x32x3/4" (19.0 mm)	3

EN L-type wheel wrench
PL Klucz do kół rozsuwany
DE Teleskop-Radmutternschlüssel
RU Ключ балонный телескопический
CZ Teleskopický klíč na kola
HU Kihúzható kerékkulcs
RO Cheie pt. roți extensibilă
FR Clé à roues extensible
IT Chiave telescopica smontaruota
ES llave para ruedas extensible
CN 轮胎套筒扳手组套

1/2"
12.7mm
385-530 mm
CrV



1/2" (12.7 mm): 17x19 mm, 21x23 mm

YATO		
YT-08040	1/2" (12.7 mm)	5/10

EN Tire expander
PL Rozpierzak do opon
DE Reifenspreizer
RU Борторасширитель
CZ Roztahovák pneumatik
HU Abroncs leszedő szerszám

RO Dispozitiv întins cauciucuri
FR Écarteur de pneus
IT Divaricatore per pneumatici
ES Esparcador de neumáticos
CN 扩胎器

85-385 mm
450 mm
FOR TIRES DO OPON



YATO	L [mm]	
YT-08120	450	9

EN Electric impact wrench
 PL Elektryczny klucz udarowy
 DE Elektro-Schlagschrauber
 RU Электрический гайковерт
 CZ Elektrický rázový utahovák
 HU Elektromos ütvecsavarozó

RO Pistol de impact electric
 FR Clé à choc électrique
 IT Avvitatore elettrico ad impulso
 ES llave de impacto eléctrica
 CN 电动冲击扳手



230V~50Hz **450 W**
450 Nm
 0-3300 min⁻¹
 1/4" 6.3 mm
 1/2" 12.7 mm
 4 m

17, 19, 21, 23 mm

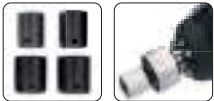

$L_{pa} = 96,0 \pm 3,0$ dB; $L_{wa} = 107,0 \pm 3,0$ dB; $a_n = 17,648 \pm 1,5$ m/s²

YATO	[W]	
YT-82020	450	4

EN Electric impact wrench
 PL Elektryczny klucz udarowy
 DE Elektro-Schlagschrauber
 RU Электрический гайковерт
 CZ Elektrický rázový utahovák
 HU Elektromos ütvecsavarozó

RO Pistol de impact electric
 FR Clé à choc électrique
 IT Avvitatore elettrico ad impulso
 ES llave de impacto eléctrica
 CN 电动冲击扳手



230V~50Hz **1020 W**
600 Nm
 0-2600 min⁻¹
 1/4" 6.3 mm
 1/2" 12.7 mm
 4 m

17, 19, 21, 23 mm

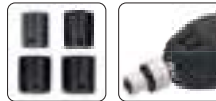

$L_{pa} = 100,0 \pm 3,0$ dB; $L_{wa} = 111,0 \pm 3,0$ dB; $a_n = 18,9 \pm 1,5$ m/s²

YATO	[W]	
YT-82021	1020	3

EN Impact tool set
 PL Zestaw narzędzi udarowych
 DE Schlagwerkzeugsatz
 RU Набор инструментов ударных
 CZ Sada příklepových nářadí
 HU Ütvecsavarozó szerszámkészlet
 RO Set pistol impact
 FR Clé à choc avec jeu d'outils
 IT Set di chiavi a percussione
 ES Juego de herramientas de impacto
 CN 锂电冲击扳手套筒组套



21 PCS
18 V Li-Ion
 1/2" 12.7 mm **700 Nm**
 0-2600 min⁻¹
 0-5000 min⁻¹
3.0 Ah
1.5h
 LED CHARGE INDICATOR
 WSKAZNIK NAŁADZANIA BATERII



1/2" (12.7 mm): 17, 19, 21 mm (L=87 mm); CrMo;
 1/2" (12.7 mm): 12, 13, 14, 15, 16, 17, 18, 19, 20, 21, 22, 23, 24 mm; CrMo;
 1/2" (12.7 mm); (L=75 mm); CrMo

$L_{pa} = 86,0 \pm 3,0$ dB; $L_{wa} = 97,0 \pm 3,0$ dB; $a_n = 7,58 \pm 1,5$ m/s²

YATO		[V d.c.]	
YT-82807	1/2" (12.7 mm)	18	2

18V
Li-Ion

EN Tire lever
PL Łyzka do opon
DE Reifenmontierhebel
RU Прибор для шиномонтажа
CZ Montážní páka na pneumatiky
HU Gumiabroncs kar
RO Levier pt. roti
FR Cuillère à pneus
IT Leva per pneumatici
ES Desmontable para las llantas
CN 轮胎起子

CrV



YATO	L [mm]		YATO	L [mm]	
YT-0807	300	20	YT-0809	500	5/20
YT-0808	400	20	YT-0810	600	5/20

EN Tire lever
PL Łyzka do opon
DE Reifenmontierhebel
RU Прибор для шиномонтажа
CZ Montážní páka na pneumatiky
HU Gumiabroncs kar
RO Levier pt. roti
FR Cuillère à pneus
IT Leva per pneumatici
ES Desmontable para las llantas
CN 撬棒

380 mm

CrMo



YATO	L [mm]	
YT-0811	380	10/50

EN Rectangular telescopic inspection mirror
PL Lusterko inspekcyjne
DE Teleskop Inspektionsspiegel
RU Зеркало инспекционное телескопическое
CZ Zrcátko kontrolní teleskopické
HU Vizsgáló tükör, teleszkópos nyéllel
RO Oglinda telescopica pt. inspectie
FR Miroir d'inspection
IT Telescopio ispezione specchietto
ES Espejo rectangular telescópico de inspección
CN 可伸缩矩形检测镜

285-770 mm

50x90 mm

TELESCOPIC HANDLE
UCHWYT
TELESKOPOWY



YATO		
YT-0660		12/144

EN LED lighted telescopic inspection mirror
PL Lusterko inspekcyjne z lampką
DE Prüfspiegel mit Beleuchtung
RU Зеркало досмотровое с подсветкой
CZ Inspekční zrcadélko s lampou
HU Vizsgáló tükör, lámpával
RO Oglindă pt. inspectie cu lampă
FR Miroir d'inspection avec lampe
IT Specchio di ispezione con lampada
ES Espejo de control con lámpara
CN 带灯检测镜

265-920 mm

54 mm

LED
LIGHT
DIODE

SS
STAINLESS STEEL
NERZEWIA



YATO		
YT-0663		10/100

EN Telescopic magnetic pick up tool
PL Chwytnak teleskopowy z magnesem
DE Teleskop magnet Heber
RU Захват магнитный телескопический
CZ Patka teleskopická magnetická
HU Felszedő mágnes, teleszkópos nyéllel
RO Telescop magnetic
FR Capteur magnétique
IT Telescopio magnete
ES Herramienta levantadora magnética, telescópica
CN 可伸缩拾拾器

250-750 mm

max 2 kg



TELESCOPIC HANDLE
UCHWYT
TELESKOPOWY



YATO		
YT-0661		12/144

EN Telescopic magnetic pick up tool
PL Chwytnak teleskopowy z magnesem
DE Teleskop magnet Heber
RU Захват магнитный телескопический
CZ Patka teleskopická magnetická
HU Felszedő mágnes, teleszkópos nyéllel
RO Telescop magnetic
FR Capteur magnétique
IT Telescopio magnete
ES Herramienta levantadora magnética, telescópica
CN 带灯可伸缩拾拾器

190-800 mm

TELESCOPIC HANDLE
UCHWYT
TELESKOPOWY

LED
LIGHT
DIODE



YATO		
YT-06611		12/144

EN 3 in 1 pick up tool
PL Zestaw do podnoszenia 3 w 1
DE 3 in 1 Hebeset
RU Подъемный набор 3 в 1
CZ Zvedací sada 3 v 1
HU 3 az 1-ben felszedő készlet
RO Dispozitiv 3 in 1 pt. recuperat
FR Kit de levage 3 en 1
IT Kit per sollevamento 3 in 1
ES Kit de elevación 3 en 1
CN 带灯拾拾器

3 in 1
3 w 1

585 mm

FLEXIBLE HANDLE
ELASTYCZNY UCHWYT

LED
LIGHT
DIODE



3x
LR1130



YATO		
YT-06613		10/60

EN Telescopic magnetic pick up tool
PL Chwytnak teleskopowy z magnesem
DE Teleskop magnet Heber
RU Захват магнитный телескопический
CZ Patka teleskopická magnetická
HU Felszedő mágnes, teleszkópos nyéllel
RO Telescop magnetic
FR Capteur magnétique
IT Telescopio magnete
ES Herramienta levantadora magnética, telescópica
CN 可伸缩磁性拾拾器

590-990 mm

82 mm

max 22.5 kg

TELESCOPIC HANDLE
UCHWYT
TELESKOPOWY



YATO	L [mm]	
YT-0860	590-990	6/24

EN Telescopic pick up and mirror set
 PL Zestaw inspekcyjny: lusterko + chwytak
 DE Inspektionsatz: Spiegel + Greifer
 RU Проверочный набор + держатель и зеркальце
 CZ Inspekční souprava: zrcadlo + držák
 HU Teleszkópos ellenőrző készlet
 RO Garnitură de control: oglindă + benă
 FR Kit miroir + grappin
 IT Set per ispezione: specchio + supporto
 ES Juego de inspección: espejo + cuchara de mordazas
 CN 检测镜、拾拾器组套

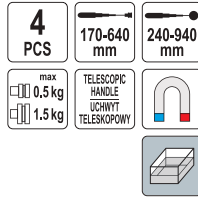

YATO
 YT-0662

10/40

EN Inspection set
 PL Zestaw inspekcyjny
 DE Inspektionsset
 RU Инспекционный набор
 CZ Inspekční sada
 HU Teleszkópos ellenőrző készlet
 RO Set de inspecție
 FR Jeu d'inspection
 IT Strumenti d'ispezione
 ES Juego herramientas inspección
 CN 套磁性伸缩拾器



172-570 mm, 84x53 mm;
 181-779 mm, Ø15 mm;
 129-648 mm, Ø5 mm;
 240-695 mm, Ø50 mm;
 283-880 mm, 84x53 mm

YATO
 YT-06622

48

EN Magnetic parts tray
 PL Miska magnetyczna
 DE Magnetschale
 RU Магнитный поднос
 CZ Miska magnetická
 HU Mágneses tálca
 RO Tava magnetica
 FR Bol magnétique
 IT Ciotola magnetica
 ES Bandeja de accesorios magnética
 CN 磁性工具盘



∅ 110 mm

∅ 150 mm

YATO
 YT-08295

12/48

YATO
 YT-0830

12/48

EN Magnetic parts tray
 PL Miska magnetyczna
 DE Magnetschale
 RU Магнитный поднос
 CZ Miska magnetická
 HU Mágneses tálca
 RO Tava magnetica
 FR Bol magnétique
 IT Ciotola magnetica
 ES Bandeja de accesorios magnética
 CN 磁力盘

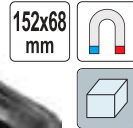

EN Magnetic parts tray
 PL Miska magnetyczna
 DE Magnetschale
 RU Магнитный поднос
 CZ Miska magnetická
 HU Mágneses tálca
 RO Tava magnetica
 FR Bol magnétique
 IT Ciotola magnetica
 ES Bandeja de accesorios magnética
 CN 磁性工具盘

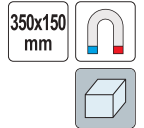

YATO
 YT-08312

48

YATO
 YT-0831

6/12

EN Magnetic parts tray
 PL Miska magnetyczna
 DE Magnetschale
 RU Магнитный поднос
 CZ Miska magnetická
 HU Mágneses tálca
 RO Tava magnetica
 FR Bol magnétique
 IT Ciotola magnetica
 ES Bandeja de accesorios magnética
 CN 磁力碗

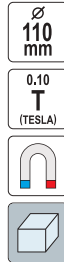

EN Magnetic parts tray
 PL Miska magnetyczna
 DE Magnetschale
 RU Магнитный поднос
 CZ Miska magnetická
 HU Mágneses tálca
 RO Tava magnetica
 FR Bol magnétique
 IT Ciotola magnetica
 ES Bandeja de accesorios magnética
 CN 磁性工具盘

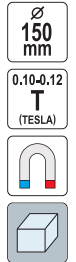

YATO
 YT-08304

24

YATO
 YT-08305

20

EN Magnetic parts tray
 PL Miska magnetyczna
 DE Magnetschale
 RU Магнитный поднос
 CZ Miska magnetická
 HU Mágneses tálca
 RO Tava magnetica
 FR Bol magnétique
 IT Ciotola magnetica
 ES Bandeja de accesorios magnética
 CN 磁力碗

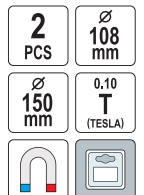

YATO
 YT-08302

6/24

EN Magnetic parts tray
PL Sortownik magnetyczny
DE Magnet-Sortierbox
RU Сортировщик
CZ Magnetický třídič
HU Mágneses rendszerező

RO Tava magnetica pt. piese
FR Rangement compartimenté magnétique
IT Separatore magnetico
ES Clasificador magnético
CN 磁力盘

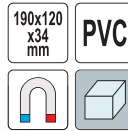

YATO
YT-08320

48

EN Magnetic wristband
PL Opaska magnetyczna
DE Magnetisches Armband
RU Магнитный браслет
CZ Magnetický náramek pro kutily
HU Mágneses karkötő
RO Bratara magnetica pt. scule
FR Bracelet magnétique
IT Braccialeto magnetico
ES Pulsera magnética
CN 磁性腕带



YATO
YT-74050

L [mm]
340

50

EN Magnetic screwdriver rack
PL Uchwyt magnetyczny na wkrętaki
DE Magnetische Halterung für Schraubendreher
RU Магнитный держатель для отверток
CZ Magnetický držák šroubováků
HU Mágneses csavarhúzó tartó

RO Raft magnetic pt. surubelnite
FR Mandrin magnétique pour tournevis
IT Supporto magnetico per punte
ES Sopoite magnético para destornilladores
CN 磁性螺丝刀架



YATO
YT-08353

L [mm]
350

6/24

EN Magnetic pliers rack
PL Uchwyt magnetyczny na narzędzia
DE Magnetischer Werkzeughalter
RU Магнитный держатель для инструментов
CZ Magnetický držák na nářadí
HU Mágneses szerszámtartó

RO Raft magnetic pt. clesti
FR Fixation magnétique pour outils
IT Supporto magnetico per attrezzi
ES Sopoite magnético para herramientas
CN 磁性钳子架



YATO
YT-08354

L [mm]
350

6/24

EN Magnetic tool holder
PL Listwa magnetyczna
DE Magnet Werkzeughalter
RU Магнитная рейка
CZ Magnetický držák nářadí
HU Mágneses tartó

RO Suport magnetic
FR Barre et porte outil magnétique
IT Striscia magnetica
ES Bandeja de accesorios magnética
CN 磁性工具架



YATO
YT-0835

4/16

EN Magnetic wristband
PL Opaska magnetyczna
DE Magnetisches Armband
RU Магнитный браслет
CZ Magnetický náramek pro kutily
HU Mágneses karkötő
RO Bratara magnetica pt. scule
FR Bracelet magnétique
IT Braccialeto magnetico
ES Pulsera magnética
CN 磁性腕带



YATO
YT-74051

L [mm]
310

50

EN Magnetic holder for tools
PL Uchwyt magnetyczny na narzędzia
DE Magnethalter für Schlagschrauber
RU Магнитный держатель для ударного гайковерта
CZ Magnetický držák nářadí
HU Mágneses tartó
RO Suport magnetic pt. scule pneumatice
FR Support magnétique pour outils pneumatiques
IT Fissaggio magnetico per chiave ad impulsi pneumatica
ES Sopoite magnético para llave de impacto
CN 磁性喷枪架



YATO
YT-08707

5/10

EN Workshop seat
 PL Taboret warsztatowy
 DE Werkstatt-Sitz
 RU Табурет рабочий
 CZ Dilenský taburet
 HU Műhely zsámoly
 RO Taburet atelier
 FR Tabouret d'atelier
 IT Sgabello da officina
 ES Taburete de taller
 CN 修车凳



EN Workshop seat with drawers
 PL Taboret warsztatowy z szufladami
 DE Werkstattthocker mit Schubladen
 RU Табурет для мастерской с выдвижными ящиками
 CZ Stolička do dílny se zásuvkami
 HU Műhelyszék fiókkal
 RO Scaun atelier cu sertare
 FR Tabouret d'atelier avec tiroirs
 IT Sgabello da officina con cassetti
 ES Taburete de taller con cajones
 CN 双抽屉修车凳

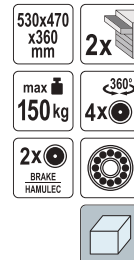

YATO **YT-08792** 1

YATO **YT-08790** 1

EN Workshop seat with drawer
 PL Taboret warsztatowy z szufladą
 DE Werkstattthocker mit Schublade
 RU Табурет для мастерской с выдвижным ящиком
 CZ Stolička do dílny se zásuvkou
 HU Műhelyszék fiókkal
 RO Scaun atelier cu tava
 FR Tabouret d'atelier avec un tiroir
 IT Sgabello da officina con un cassetto
 ES Taburete de taller con cajón
 CN 轻型修车凳



EN Adjustable roller stool with drawers
 PL Siedzisko warsztatowe z szufladami
 DE Werkstatt-Sitz mit Schubladen
 RU Сиденье для мастерской с выдвижными ящиками
 CZ Sedátko do dílny se zásuvkami
 HU Műhelyszék fiókkal
 RO Scaun atelier reglabil
 FR Siège d'atelier avec tiroirs
 IT Seggiolino da officina con cassetti
 ES Silla de taller con cajones
 CN 重型方形修车凳



EN Adjustable workshop seat
 PL Siedzisko warsztatowe teleskopowe
 DE Werkstattthocker, teleskopisch
 RU Сиденье для мастерской
 CZ Nastavitelné dílenské sedátko
 HU Teleszkópos műhely zsámoly
 RO Scaun atelier reglabil
 FR Tabouret d'atelier télescopique
 IT Sgabello da officina regolabile
 ES Taburete de taller neumático
 CN 修车凳



YATO **YT-08791** 2

YATO **YT-08795** 1

YATO **YT-08793** 1

EN Workshop creeper
 PL Leżanka warsztatowa
 DE Werkstatt-Liege
 RU Лежак ремонтный
 CZ Montážní lehátko
 HU Fekpad gurulós

RO Targă service
 FR Chariot de visite
 IT Lettino sottomacchina
 ES Camilla para mecánico
 CN 修车躺板



YATO **YT-0880** 1

EN Workshop creeper
 PL Leżanka warsztatowa
 DE Werkstatt-Liege
 RU Лежак ремонтный
 CZ Montážní lehátko
 HU Fekpad gurulós

RO Targă service
 FR Chariot de visite
 IT Lettino sottomacchina
 ES Camilla para mecánico
 CN 修车躺板



YATO **YT-08802** 1

EN Kneeling mat
 PL Mata pod kolana
 DE Kniematte
 RU Подставка для колен
 CZ Podložka pod kolena
 HU Térdalát
 RO Covoraș pt. genunchi
 FR Tapis de protection des genoux
 IT Tappetino per ginocchia
 ES Alfombrilla para las rodillas
 CN 跪垫



YATO **YT-08280** 40

EN Workshop mat set
 PL Zestaw mat warsztatowych
 DE Werkstattmatten
 RU Пеньные коврики для мастерской
 CZ Pěnové podložky do dílny
 HU Hab garázs szőnyegek
 RO Pres pt. atelier
 FR Jeu de tapis antidérapants
 IT Set di stuoie per officina
 ES Baldosas para taller
 CN 地垫

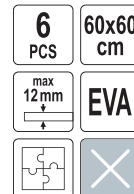

YATO **YT-08780** 6

EN Automotive circuit tester
PL Wskaźnik elektryczny samochodowy
DE KFZ Prüflampe

RU Пробник напряжения автомобильный
CZ Zkoušečka napětí autoelektrikářská
HU Autóvillamosági teszter

RO Tester pt. circuite auto
FR Testeur de tension de voiture
IT Tester elettrico per auto

ES Indicador eléctrico de coche
CN 汽车测电笔



6-24V
90cm

YATO
YT-2865 25/250



6-12V
90cm

YATO
YT-2866 10/100

3-48V

2.7 m

LED
DISPLAY
WYSWIETLACZ

YATO
YT-28667 25/100

EN Cloth cable wrap tape
PL Taśma parczana do wiązek kabli
DE Gewebeband für Kabelbäume
RU Лента холщевая для кабельных пучков
CZ Plátěná páska do kabelových svazků
HU Poliészter kábelköteg szalag
RO Banda panza pt. izolat cabluri
FR Ruban adhésif textile
IT Nastro di tela per cablaggi
ES Cinchas para haces de cables
CN 绒布线束胶布



HOT MELT
GLUE
KLEJ
GORACCO-
TOPLIWY
NONWOVEN
FABRIC
WŁOKNINA
-40
+105

YATO	W [mm]	L [m]	± [mm]	
YT-81500	19	15	0.3	10/200
YT-81501	19	25	0.3	10/120

EN Number stamps
PL Znaczniki cyfrowe
DE Nummernstempel
RU Клейма цифровые
CZ Razidla číselná
HU Számbeütők
RO Poansoane cu cifre
FR Chiffres à frapper
IT Punzoni marcatori
ES Marcadores de números
CN 数字冲模



9
PCS
0 - 9
NUMBERS
NUMERY
HRC
50-55
1045
CARBON STEEL
STAL WĘGLOWA

YATO	Digit height / Wysokość cyfr [mm]	pcs / szt.	
YT-6854	6	9	20
YT-6855	8	9	18

EN Letter stamps
PL Znaczniki literowe
DE Buchstabenstempel
RU Клейма буквенные
CZ Razidla písmenová
HU Betűbeütők
RO Poansoane cu litere
FR Lettres à frapper
IT Punzoni marcatori
ES Marcadores de letras
CN 字母冲模



27
PCS
A-Z|&
LETTERS
LETTRY
HRC
50-55
1045
CARBON STEEL
STAL WĘGLOWA

YATO	Letter height / Wysokość liter [mm]	pcs / szt.	
YT-6862	6	27	12
YT-6863	8	27	8

EN Lambda sensor thread chaser
PL Zestaw do naprawy gwintów sondy lambda
DE Lambdasonde Gewinde Reparatur-Set
RU Набор для ремонта сорванной резьбы винтов
CZ Sada na opravu závitu lambda sondy
HU Menejjavító készlet lambda szondához
RO Dispozitiv pt. curatat filet sonda lambda
FR Set de réparation filetage de sonde lambda
IT Chiavi a bussola per sonda lambda
ES Cazador del hilo de rosca para sonda lambda
CN 火星塞丝攻组套

M12
x1.25
M18
x1.5
HRC
50
FOR OXYGEN
SENSOR
DO SONDA
LAMBDA



YATO
YT-1756 12/96

EN Oil pan thread repair set
PL Zestaw naprawczy korków do miski olejowej
DE Reparatursatz für Verschlussstopfen von Ölwanen
RU Набор для ремонта масляных пробок
CZ Souprava na opravu vypouštěcích šroubů olejových van
HU Olajleknő-csavar javítókészlet
RO Set pt. reparare dopuri baie de ulei
FR Kit réparation de bouchons de carter d'huile
IT Set per riparazione dei tappi della coppa del olio
ES Juego de reparación para los tapones del cárter de aceite
CN 螺纹修复组套

64
PCS
CrMo



M13	5 pcs	M13	13 mm	10 pcs	M17	5 pcs	M17	17 mm	10 pcs
M15	5 pcs	M15	15 mm	10 pcs	M20	5 pcs	M20	20 mm	10 pcs

YATO
YT-1757 5

- EN Oil pan thread repair set
- PL Zestaw naprawczy korków do miski olejowej
- DE Reparatursatz für Verschlussstopfen von Ölwanne
- RU Набор для ремонта масляных пробок
- CZ Souprava na opravu vuroušťecích šroubů olejových van
- HU Olajteknő-csavar javítókészlet
- RO Set pt. reparare dopuri baie de ulei
- FR Carter d'huile fil kit de réparation
- IT Set per riparazione dei tappi della coppa del olio
- ES Juego de reparación para los tapones del cárter de aceite
- CN 螺纹修复组套



7
PCS

YATO	Thread size / Rozmiar gwintu	
YT-17571	M13x1.5 mm	10/40
YT-17572	M15x1.5 mm	10/40
YT-17573	M17x1.5 mm	10/40
YT-17574	M20x1.5 mm	10/40
YT-17575	M22x1.5 mm	10/40

- EN Thread repair set
- PL Zestaw do naprawy gwintów
- DE Reparatursatz für Gewinde
- RU Набор для ремонта резьбы
- CZ Souprava na opravu závitů
- HU Menetjavító készlet
- RO Set pt. reparare filete
- FR Set d'helicoils
- IT Kit di riparazione per filettature
- ES Juego para reparar roscas
- CN 螺纹修复组套

131
PCS

HSS 4341

SS
STAINLESS STEEL
STAL NIERDZEWNA



YATO	Dimensions / Wymiary	
YT-1763	M5x0.8x6.7 mm, M6x1x10.8 mm, M8x1.25x10.8 mm, M10x1.5x13.5 mm, M12x1.75x16.3 mm	5/10

- EN Thread repair set
- PL Zestaw do naprawy gwintów
- DE Reparatursatz für Gewinde
- RU Набор для восстановления резьбы свечи зажигания
- CZ Sada pro opravu závitů zážehové svíčky
- HU Gyújtógyertya menetjavító készlet
- RO Set reparat filet bujie
- FR Kit de réparation du filetage de bougie d'allumage
- IT Kit di riparazione per cavi di candele di accensione
- ES Kit de reparación para rosca de bujía de encendido
- CN 火花塞螺纹修复工具



HSS 4241 4341

SS
STAINLESS STEEL
STAL NIERDZEWNA

YATO	Thread size / Rozmiar gwintu	pcs / szt.	
YT-17631	M5x0.8 mm	30	20/40
YT-17632	M6x1.0 mm	30	20/40
YT-17633	M8x1.25 mm	30	20/40
YT-17634	M10x1.5 mm	30	20/40
YT-17635	M12x1.75 mm	30	20/40

- EN Thread repair set
- PL Zestaw do naprawy gwintów
- DE Reparatursatz für Gewinde
- RU Набор для ремонта резьбы
- CZ Souprava na opravu závitů
- HU Menetjavító készlet
- RO Set pt. reparare filete
- FR Set d'helicoils
- IT Kit di riparazione per filettature
- ES Juego para reparar roscas
- CN 螺纹修复组套

88
PCS

HSS 4341

SS
STAINLESS STEEL
STAL NIERDZEWNA



YATO	Dimensions / Wymiary	
YT-1769	M6x1x10.8 mm, M8x1.25x10.8 mm, M10x1.5x13.5 mm	5/10

- EN Wire threads
- PL Wkłady spiralne do naprawy gwintów
- DE Spiraleinlagen für Gewindereparatur
- RU Метчики и сверла для ремонта резьбы
- CZ Spirálové vložky na opravu závitů
- HU Menetjavító betétek
- RO Inserți spirală pt. reparare filete
- FR Helicoil
- IT Inserti a spirale per riparazione
- ES Elementos espirales para reparar roscas
- CN 不锈钢螺纹套

SS
STAINLESS STEEL
STAL NIERDZEWNA



For YT-1763, YT-1769
Dla YT-1763, YT-1769

YATO	Dimensions / Wymiary	pcs / szt.	
YT-1764	M5x0.8x6.7 mm	20	50/250
YT-1765	M6x1x10.8 mm	20	50/250
YT-1766	M8x1.25x10.8 mm	20	50/200
YT-1767	M10x1.5x13.5 mm	15	25/100
YT-1768	M12x1.75x16.3 mm	10	25/100

- EN Spark plug thread repair set
- PL Zestaw naprawczy gwintu świecy zapłonowej
- DE Reparatursatz für Zündkerzengewinde
- RU Набор для восстановления резьбы свечи зажигания
- CZ Sada pro opravu závitů zážehové svíčky
- HU Gyújtógyertya menetjavító készlet
- RO Set reparat filet bujie
- FR Kit de réparation du filetage de bougie d'allumage
- IT Kit di riparazione per cavi di candele di accensione
- ES Kit de reparación para rosca de bujía de encendido
- CN 火花塞螺纹修复工具

16
PCS

M14 x1.25

11.5 mm

M16 x1.25

17.5 mm



YATO	
YT-17580	20

- EN Spark plug thread repair set
PL Zestaw naprawczy gwintu świecy zapłonowej
DE Reparatursatz für Zündkerzengewinde
RU Набор для восстановления резьбы свечи зажигания
CZ Sada pro opravu závitů zážehové svíčky
HU Gyújtógyertya menetjavító készlet
RO Set reparat filet bujie
FR Kit de réparation du filetage de bougie d'allumage
IT Kit di riparazione per cavi di candele di accensione
ES Kit de reparación para rosca de bujía de encendido
CN 火花塞螺纹修复工具

25
PCS

M14
x1.25

10
mm

15
mm

3/8"
9.5mm

HSS



YATO
YT-17581

10

- EN Internal spark plug thread chaser set
PL Zestaw gwintowników do świec
DE Nachschneider-Set für Zündkerzen-Gewinde
RU Набор метчиков резьбы под свечи накалвания
CZ Sada na opravu závitů zapalovacích svíček
HU Gyújtógyertya menetjavító készlet
RO Set de curățare filet bujii interne
FR Set de tarauds pour filetage de bougie d'allumage
IT Kit di maschi per candele
ES Juego de machos rosca para bujias
CN 火花塞螺纹修复工具

7
PCS

CrMo

LONG
DELUGE



M8 x 1.0 x 115 mm, M10 x 1.0 x 115 mm, M12 x 1.25 x 135 mm, M12 x 1.25 x 260 mm, M14 x 1.25 x 130 mm, M14 x 1.25 x 260 mm, M18 x 1.5 x 80 mm

YATO
YT-17708

10

- EN Brake calliper guide bolt repair tool set
PL Zestaw naprawczy prowadnic zacisków hamulcowych
DE Reparatursatz für Bremssattelführungen
RU Набор для ремонта направляющих тормозного суппорта
CZ Sada pro opravu vodítek brzdových třmenů
HU Féknyereg vezetőpersely szerelő készlet
RO Set de instrumente pt. repararea suruburilor ghidajului etrierului
FR Kit de réparation pour les guides d'étrier de frein
IT Kit di riparazione per guide di scorrimento delle pinze di freni
ES Kit de reparación para guías de mordazas de freno
CN 刹车卡钳螺栓修复工具

12
PCS

M10
x1.25

HSS

VAG

FORD
OPEL



Ford, Opel, VAG

YATO
YT-17588

20

- EN Spark plug thread chaser
PL Zestaw do naprawy gwintów świec
DE Stopfengewinde-Reparaturset
RU Набор для ремонта резьбы свечей
CZ Sada na opravu závitů svíček
HU Gyertyamenet javító készlet
RO Curatator filet bujie
FR Kit de réparation pour filet de bougies d'allumage
IT Kit per riparazione di filettature di candele
ES Kit de reparación de roscas de bujía
CN 火星塞螺纹组套

2
PCS

M10x1.0
M12x1.25
M14x1.5
M18x1.5

21
mm

HRC
50



YATO
YT-17697

16/64

- EN Glow plug threads repair kit
PL Zestaw naprawczy gwintów świec żarowych
DE Reparatursatz für Glühkerzengewinde
RU Набор для ремонта резьбы свечи накалвания
CZ Sada pro opravu závitů žhavicích svíček
HU Izzítógyertya menetjavító készlet
RO Set de reparare filete bujii incandescente
FR Kit de réparation pour les filetages des bougies de préchauffage
IT Kit di riparazione per filettature di candele di accensione
ES Kit de reparación para roscas de bujías de calentamiento
CN 火花塞螺纹修复工具

33
PCS

M8
x1.0

M10
x1.0

M10
x1.25

M12
x1.25



Included / W zestawie: reamers / rozwiertaki: M8x1.0, M10x1.0, M10x1.25, M12x1.0, M12x1.25, M14x1.25; threaded sleeves / tuleje gwintowane: M8x1.0, M10x1.0, M10x1.25, M12x1.25 (x5 PCS); screws / śruby prowadzące (3 PCS); taps for rethreading the original thread / gwintowniki do poprawy gwintów (2 PCS); handle / uchwył

YATO
YT-17710

10

- EN Brake thread repair set
PL Zestaw naprawczy gwintów zacisku hamulcowego
DE Gewindereparaturatz für Bremssattel
RU Комплект для ремонта резьбы суппорта тормоза
CZ Sada na opravu závitů brzdového třmenu
HU Féknyereg menetjavító készlet
RO Set reparat cablu de frana
FR Kit de réparation pour filetages d'étriers de frein
IT Kit di riparazione per filettature di pinze di freni
ES Kit de reparación de roscas para pinzas de freno
CN 刹车螺纹修复工具

16
PCS

M9
x1.25

HSS



Ford, Opel, VAG

YATO
YT-17700

10

EN Rethread tool kit set
 PL Zestaw do naprawy gwintów śrub i nakrętek
 DE Gewindereparatursatz für Schrauben und Mutter
 RU Комплект для ремонта резьбы на винтах и гайках
 CZ Sada pro opravu závitů na šroubech a maticích
 HU Csavarok és anyák meneteinek javítására szolgáló készlet

RO Kit pt. reparat filete
 FR Kit de réparation de filetage
 IT Kit di riparazione delle filettature viti e dadi
 ES Kit de reparación de roscas en tornillos y tuercas
 CN 螺纹修复工具组套

15
PCS

METRIC
METRYCZNY



Metric thread file pitches / Pilniki do naprawy gwintów: 0.75, 1.0, 1.25, 1.5, 1.75, 2.0, 2.5, 3.0 mm;
 Rethreader dies / Narzynki: 6x1.00, 8x1.25, 10x1.25, 10x1.50, 12x1.25, 12x1.50, 12x1.75 mm;
 Rethreader taps / Gwintowniki: 6x1.00, 8x1.25, 10x1.25, 10x1.50, 12x1.25, 12x1.50, 12x1.75 mm

YATO

YT-17705

20

EN Injector clamping bolt thread repair kit
 PL Zestaw naprawczy do gwintów śrub mocujących wtryskiwacze
 DE Gewinde-Reparatur Satz für Injektor-Befestigungsschraube
 RU Набор для ремонта резьбы крепежных винтов форсунок
 CZ Sada na opravu závitů upevňovacích šroubů vstřikovače
 HU Menetjavító készlet befecskendezők rögzítőcsavarjaihoz
 RO Kit de reparare a filetelui șurubului de strângere a injectoriului
 FR Kit de réparation filetage pour vis de fixation injecteur
 IT Kit per riparazione di filettature delle viti di fissaggio per iniettori
 ES Kit de reparación de roscas de tornillos de fijación de inyectores
 CN 喷油器夹紧螺栓螺纹修复

10
PCS

MERCEDES

M6X1

HSS





YATO

YT-06036

10

EN Foot pump with gauge
 PL Pompka nożna z manometrem
 DE Fusspumpe
 RU Насос ножный с манометром
 CZ Nožní pumpa s manometrem
 HU Lábpumpa nyomásmérővel
 RO Pompă de picior cu manometru
 FR Pompe à pied avec manomètre
 IT Pompa a pedale con manometro
 ES Bomba de pierna con manometro
 CN 打气筒

0.7
MPa
(max.)



YATO

YT-7349

10

EN Axle spindle rethreading set
 PL Zestaw do naprawy gwintów pólasi
 DE Gewindereparatur Set Antriebswelle
 RU Набор для восстановления резьбы оси шруца
 CZ Souprava k opravě závitů hnacích hřídelí
 HU Résztes menetjavító készlet főtengelyekhez

RO Trusa pt. reparat filetele la planetare
 FR Kit réparation filetage cardan
 IT Kit di ripristino di filetti dei semiassi
 ES Kit de herramienta de la reparación
 CN 传动轴螺杆修复组套

8
PCS

5/4"
32mm



M24x1.5; M24x2.0; M22x1.0; M22x1.5; M20x1.5; M20x1.5; 3/4x20 UNEF; 13/16x20 UNEF

YATO

YT-17695

10

EN Pressure gauge
 PL Wskaźnik ciśnienia
 DE Druckanzeige
 RU Манометр
 CZ Tlakomer
 HU Nyomásmérő

RO Indicator de presiune
 FR Manomètre
 IT Manometro
 ES Manómetro
 CN 压力计

0-15
bar

0-220
psi

140
mm

FOR TRUCKS
DO AUT
CIEZAROWYCH



YATO

YT-24301

25/100

EN Foot pump with gauge
 PL Pompka nożna z manometrem
 DE Fusspumpe
 RU Насос ножный с манометром
 CZ Nožní pumpa s manometrem
 HU Lábpumpa nyomásmérővel
 RO Pompă de picior cu manometru
 FR Pompe à pied avec manomètre
 IT Pompa a pedale con manometro
 ES Bomba de pierna con manometro
 CN 带压力表双管打气筒

0.7
MPa
(max.)

TWIN
PISTON
PODWOJNY
TŁOK



YATO

YT-7350

10

EN Hand pump with manometer
PL Pompka słupkowa z manometrem
DE Hand-Luftpumpe mit Manometer
RU Насос ручной с манометром
CZ Pumpa s manometrem
HU Kézi pumpa manométerrel
RO Pompa de mana cu manometru
FR Pompe manuelle avec manomètre
IT Pompa verticale con manometro
ES Bomba de barrote con manometro
CN 直立式打气筒 (機械錶)



0.8 MPa (max.)
0-120 psi
65 cm
UNIVERSAL DOUBLE HEAD
UNIVERSALNA GŁOWICA
PODWÓJNA



YATO [V d.c.]
YT-73521 3

EN Rechargeable air compressor
PL Kompressor bezprzewodowy
DE Kabelloser Kompressor
RU Беспроводной компрессор
CZ Bezdrátový kompresor
HU Vezeték nélküli kompresszor
RO Compressor de aer reincărcabil
FR Compresseur sans-fil
IT Compressore senza fili
ES Compresor inalámbrico
CN 充气泵

120 W
1.0 MPa
25 l/min
11.1V 2200mAh
4h
20min
USB CHARGING
LADOWANIE
25 cm
LED LIGHTING
OSWIETLENIE



Setups / Ustawienia: 3-150 psi, 0.2-10.3 bar, 20-995 kPa, 0.2-10.5 kg/cm²

YATO [V d.c.]
YT-82950 11.1 (3.7 x3) 12

EN Car air compressor
PL Kompressor samochodowy
DE Auto-Kompressor
RU Автомобильный компрессор
CZ Automobilový kompresor
HU Autókompresszor
RO Compresor auto
FR Compresseur de voiture
IT Compressore d'auto
ES Compresor de coche
CN 车用充气泵



120 W
1.0 MPa
12V
25 l/min
LED
60 cm
3 m



YATO [W]
YT-73470 120 12

EN Car air compressor
PL Kompressor samochodowy
DE Auto-Kompressor
RU Автомобильный компрессор
CZ Automobilový kompresor
HU Autókompresszor
RO Compresor auto
FR Compresseur de voiture
IT Compressore d'auto
ES Compresor de coche
CN 车用充气泵

180 W
1.0 MPa
12V
40 l/min
1 m
3 m



YATO [W]
YT-73460 180 8

EN Car air compressor
PL Kompressor samochodowy
DE Auto-Kompressor
RU Автомобильный компрессор
CZ Automobilový kompresor
HU Autókompresszor
RO Compresor auto
FR Compresseur de voiture
IT Compressore d'auto
ES Compresor de coche
CN 车用充气泵

250 W
1.0 MPa
12V
60 l/min
5 m
3 m



YATO [W]
YT-73462 250 4

EN Air compressor
 PL Kompressor olejowy
 DE Ölkompressor
 RU Масляный компрессор
 CZ Olejový kompresor
 HU Olajos kompresszor
 RO Compresor
 FR Compresseur à pistons
 IT Comprensore d'aria
 ES Compresor de pistón
 CN 直连式空压机

230-240V~
50Hz

1.5kW
2KM

1500
W

2850
min⁻¹



0.8
MPa

200
l/min

24L



$L_{PA} = 74.2 \pm 3.0$ dB; $L_{WA} = 93.7 \pm 2.23$ dB

YATO 	[W]	
YT-23300	1500	1

EN Air compressor
 PL Kompressor olejowy
 DE Ölkompressor
 RU Масляный компрессор
 CZ Olejový kompresor
 HU Olajos kompresszor
 RO Compresor
 FR Compresseur à pistons
 IT Comprensore ad olio
 ES Compresor de pistón
 CN 直连式空压机

230-240V~
50Hz

1.5kW
2KM

1500
W

2850
min⁻¹



0.8
MPa

200
l/min

50L



$L_{PA} = 74.2 \pm 3.0$ dB; $L_{WA} = 93.7 \pm 2.23$ dB

YATO 	[W]	
YT-23305	1500	1

EN Air compressor
 PL Kompressor olejowy
 DE Ölkompressor
 RU Масляный компрессор
 CZ Olejový kompresor
 HU Olajos kompresszor
 RO Compresor
 FR Compresseur à pistons
 IT Comprensore ad olio
 ES Compresor de pistón
 CN 直连式空压机

230V~
50Hz

2.2kW
3KM

2200
W

1100
min⁻¹

2x 



1.0
MPa

360
l/min

100L



$L_{PA} = 74.7 \pm 3.0$ dB; $L_{WA} = 93.8 \pm 2.28$ dB

YATO 	[W]	
YT-23310	2200	1

EN Air compressor
 PL Kompressor olejowy
 DE Ölkompressor
 RU Масляный компрессор
 CZ Olejový kompresor
 HU Olajos kompresszor
 RO Compresor
 FR Compresseur à pistons
 IT Comprensore d'aria
 ES Compresor de pistón
 CN 直连式空压机

230V~
50Hz

2.2kW
3KM

2200
W

1100
min⁻¹

2x 



1.0
MPa

360
l/min

200L



$L_{PA} = 74.7 \pm 3.0$ dB; $L_{WA} = 93.8 \pm 2.28$ dB

YATO 	[W]	
YT-23320	2200	1

EN Air wedge
PL Poduszka montażowa
DE Luft Keil
RU Монтажная подушка
CZ Rozpínací montážní polštář
HU Emelőpárna
RO Perna de aer
FR Coussin élévateur
IT Cuscino di montaggio
ES Cojines elevadores
CN 门窗安装气囊

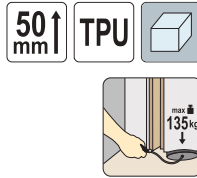

YATO	Size / Rozmiar [mm]	
YT-67380	150x160	24
YT-67381	165x150	48
YT-67382	190x110	48
YT-67383	270x130	48

EN Tire rack
PL Stojak na kola
DE Reifenständer
RU Стойка для колес
CZ Stojan na pneumatiky
HU Keréktartó állvány
RO Suport pt. anvelope
FR Support pour roues
IT Supporto verticale per pneumatici
ES Soporte para llantas
CN 轮胎架

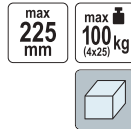

YATO	
YT-55690	1

EN Oil jug
PL Nalewak warsztatowy
DE Ölkanne
RU Лейка пластиковая с крышкой
CZ Odměrka plastová - konev
HU Olajbetöltő kanna
RO Recipient ulei
FR Broc verseur avec couvercle
IT Serbatoio
ES Jarra con pitorro de aceite
CN 油壶



YATO	[l]	
YT-06980	1	48
YT-06983	3	40
YT-06985	5	16

EN Air pump wedge set
PL Zestaw poduszek montażowych
DE Montagekissen-Set
RU Набор монтажных подушек
CZ Rozpínací polštářky
HU Szerelőpárna készlet
RO Set perne de aer
FR Coussins d'air pour soulever
IT Set di cuscinetti gonfiabili per montaggio porte e finestre
ES Juego de bolsas de cuña de aire
CN 门窗安装气囊

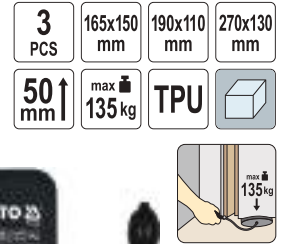

YATO	
YT-67385	48

EN Mobile tire rack
PL Mobilny stojak na kola
DE Mobiler Reifenständer
RU Мобильная стойка для хранения шин
CZ Pojízdný stojan na pneumatiky
HU Mobil keréktartó állvány
RO Suport mobil pt. anvelope
FR Support pour roues mobile
IT Supporto verticale mobile per pneumatici
ES Soporte para llantas móvil
CN 移动式轮胎挂架

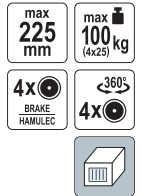

YATO	
YT-55691	6

EN Oil jug
PL Nalewak warsztatowy
DE Ölkanne
RU Лейка пластиковая с крышкой
CZ Odměrka plastová - konev
HU Olajbetöltő kanna
RO Recipient ulei
FR Broc verseur avec couvercle
IT Serbatoio
ES Jarra con pitorro de aceite
CN 油壶



YATO	[l]	
YT-06987	10	8

EN Funnel
PL Lejek
DE Trichter
RU Воронка гибкая
CZ Nálevka
HU Kétrészes tölcser

RO Pâlnie
FR Entonnoir
IT Imbuto
ES Embudo
CN 漏斗

∅ 135 mm
PP
✕



YATO	∅ [mm]	
YT-0694	135	192

EN Long funnel
PL Lejek dlugi
DE Trichter
RU Воронка гибкая
CZ Nálevka
HU Kétrészes tölcser
RO Pâlnie
FR Entonnoir
IT Imbuto
ES Embudo
CN 漏斗

∅ 120 mm
455 mm
PP
✕



YATO	L [mm]	∅ [mm]	
YT-0693	455	120	48

EN Operating fluids funnel
PL Lejek do płynów eksploatacyjnych
DE Trichter
RU Воронка гибкая
CZ Nálevka
HU Kétrészes tölcser

RO Pâlnie
FR Entonnoir
IT Imbuto
ES Embudo
CN 漏斗

∅ 100 mm
PP
✕



YATO	∅ [mm]	
YT-0695	100	180

EN Operating fluids funnel
PL Lejek do płynów eksploatacyjnych
DE Trichter
RU Воронка гибкая
CZ Nálevka
HU Kétrészes tölcser

RO Pâlnie
FR Entonnoir
IT Imbuto
ES Embudo
CN 漏斗

∅ 240 mm
PP
✕



YATO	∅ [mm]	
YT-0696	240	48

EN Fuel and oil funnel
PL Lejek do paliwa i oleju
DE Trichter
RU Воронка гибкая
CZ Nálevka
HU Kétrészes tölcser
RO Pâlnie
FR Entonnoir
IT Imbuto
ES Embudo
CN 漏斗

∅ 150 mm
PP
✕



YATO	∅ [mm]	
YT-0692	150	30

EN Oil funnel
PL Lejek do oleju
DE Trichter
RU Воронка гибкая
CZ Nálevka
HU Kétrészes tölcser

RO Pâlnie
FR Entonnoir
IT Imbuto
ES Embudo
CN 漏斗

∅ 280 mm
PP
✕



YATO	∅ [mm]	
YT-0697	280	48

EN Oil funnel with handle
PL Lejek specjalny z uchwytem
DE Spezialtrichter mit Griff
RU Специальная воронка с ручкой
CZ Speciální trychťyf s rukojetí
HU Speciális tölcser fogantyúval
RO Pâlnie pt. ulei cu maner
FR Entonnoir spécial avec poignée
IT Imbuto speciale con impugnatura
ES Embudo especial con soporte
CN 漏斗



∅ 20/125 mm
NYLON
PP

YATO	∅ [mm]	
YT-06972	20, 125	10/20

EN Manual car oil pump
PL Odsysarka ręczna do oleju
DE Manuelle Öl-Absaugpumpe
RU Ручной насос для откачки масла
CZ Ruční vakuová odsávačka oleje a kapalin
HU Kézi pumpás olajleszívó
RO Pompă de aspirație pt. aspirația uleiului
FR Pompe à vide pour aspiration d'huile
IT Aspiratore manuale per olio
ES Bomba de vacío para aspiración de aceite
CN 手动抽油机



9L
3 SUCTION PROBES (SNDY-SRACE)
FOR OIL DO OLEJU

YATO	
YT-07087	4

EN Waste oil storage container
PL Pojemnik zlewowy do oleju
DE Öl-Auffangkanister
RU Емкость для слива отработанного масла
CZ Nádobá na použitý olej
HU Fáradt olaj gyűjtő

RO Canistra colectare ulei
FR Bidon de collecte d'huile
IT Tanica per cambio olio
ES Bidón cambio de aceite
CN 积油壶



600x330
x110
mm

8L

PE

EN Oil drainer
PL Zlewarka do oleju
DE Öleinfüllanlage
RU Устройство для слива масла
CZ Olejová nádrž s odsáváním
HU Fáradtolaj leszívó
RO Dispozitiv pt. schimbare ulei
FR Récupérateur d'huile
IT Scolapiatti dell'olio
ES Decantador para aceite
CN 泄油器

20L

∅ 42
cm

75-155
cm

PE



YATO	[l]	[mm]	
YT-0695	8	600x330x110	4

EN Oil drain pan
PL Miska do oleju
DE Ölwanne
RU Поддон для слива масла
CZ Miska na olej
HU Fáradt olaj felfogó edény

RO Vas pt. ulei
FR Bac de récupération d'huile
IT Vaschetta per cambio olio
ES Recipiente para drenaje de aceite
CN 接油盆



7L

PP

YATO	[l]	∅ [mm]	
YT-0699	7	370	24

EN Oil drain pan
PL Miska do oleju
DE Ölwanne
RU Поддон для слива масла
CZ Miska na olej
HU Fáradt olaj felfogó edény

RO Vas pt. ulei
FR Bac de récupération d'huile
IT Vaschetta per cambio olio
ES Recipiente para drenaje de aceite
CN 接油盆



PE

YATO	[l]	∅ [mm]	
YT-0716	10	370	6
YT-0717	15	420	4

YATO	[l]	∅ [mm]	
YT-0718	20	420	1

EN Farm jack
PL Podnośnik farmerski
DE Bauernhof-Jack
RU Домкрат механический реечный
CZ Zvedák farm jack
HU Hi-jack fogaslécés off-road emelő
RO Cric mecanic tip off-road
FR Vérins mécaniques commerciaux
IT Farm jack - sollevatore di auto
ES Elevación mecánicas comerciales
CN 农夫顶

3t

690
115
mm



YATO	[t]	Lifting range / Zakres podnoszenia [mm]	
YT-17260	3	115-690	1

EN Farm jack
PL Podnośnik farmerski
DE Bauernhof-Jack
RU Домкрат механический реечный
CZ Zvedák farm jack
HU Hi-jack fogaslécés off-road emelő
RO Cric mecanic tip off-road
FR Vérins mécaniques commerciaux
IT Farm jack - sollevatore di auto
ES Elevación mecánicas comerciales
CN 农夫顶

3t

1060
125
mm



YATO	[t]	Lifting range / Zakres podnoszenia [mm]	
YT-17261	3	125-1060	1

EN Farm jack
PL Podnośnik farmerski
DE Bauernhof-Jack
RU Домкрат механический реечный
CZ Zvedák farm jack
HU Hi-jack fogaslécés off-road emelő
RO Cric mecanic tip off-road
FR Vérins mécaniques commerciaux
IT Farm jack - sollevatore di auto
ES Elevación mecánicas comerciales
CN 农夫顶

3t



1320
125
mm



YATO	[t]	Lifting range / Zakres podnoszenia [mm]	
YT-17262	3	125-1320	1

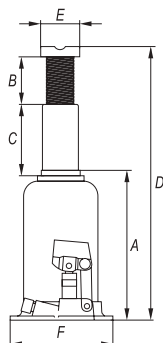

EN Hydraulic bottle jack
 PL Podnośnik hydrauliczny słupkowy
 DE Hydraulischer Stempelwagenheber
 RU Домкрат гидравлический
 CZ Pístový zvedák hydraulický
 HU Hidraulikus emelő
 RO Cric hidraulic
 FR Cric hydraulique bouteille
 IT Cric idraulico a bottiglia
 ES Gato hidráulico de botella
 CN 立式液压千斤顶



YATO 	[t]	A [mm]	B [mm]	C [mm]	D [mm]	E [mm]	F [mm]	
YT-17000	2	181	48	116	345	25	88x92	6
YT-17001	3	194	60	120	374	27	92x100	6
YT-17002	5	216	60	137	413	29	96x110	4
YT-17003	8	230	80	147	457	32	103x118	2
YT-17004	10	230	80	150	460	36	110x123	2
YT-17005	12	230	80	155	465	40	116x134	2
YT-17006	15	230	82	150	462	43	140x134	2
YT-17007	20	242	60	150	452	45	144x150	2
YT-17008	32	285	-	180	465	69	190x152	1
YT-17009	50	300	-	180	480	83	218x176	1

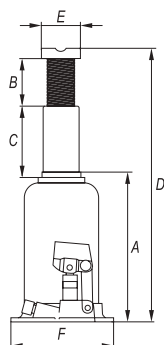

EN Hydraulic bottle jack
 PL Podnośnik hydrauliczny słupkowy
 DE Hydraulischer Stempelwagenheber
 RU Домкрат гидравлический
 CZ Pístový zvedák hydraulický
 HU Hidraulikus emelő
 RO Cric hidraulic
 FR Cric hydraulique bouteille
 IT Cric idraulico a bottiglia
 ES Gato hidráulico de botella
 CN 立式液压千斤顶



YATO 	[t]	A [mm]	B [mm]	C [mm]	D [mm]	E [mm]	F [mm]	
YT-17015	2	172	88	112	372	28	103x105	4
YT-1702	5	218	110	146	474	40	110x112	5
YT-17025	8	220	115	153	488	45	124x127.5	2
YT-1704	10	220	115	148	483	48	124x127.5	3
YT-17045	12	230	115	160	505	45	130x136	2
YT-1706	15	228	113	154	508	56	140x142	2
YT-1707	20	241	115	165	521	60	165x161	2
YT-17075	25	240	110	160	510	65	186x174	1
YT-1709	30	244	108	140	510	65	186x174	1

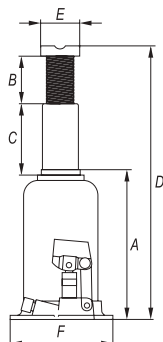

EN Two-piston hydraulic bottle jack
 PL Podnośnik hydrauliczny słupkowy dwutokowy
 DE Hydraulischer Stempelwagenheber
 RU Домкрат гидравлический
 CZ Pístový zvedák hydraulický
 HU Hidraulikus emelő
 RO Cric hidraulic
 FR Cric hydraulique bouteille
 IT Cric idraulico a bottiglia
 ES Gato hidráulico de botella
 CN 液压双级千斤顶

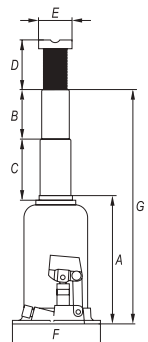

YATO 	[t]	A [mm]	B [mm]	C [mm]	D [mm]	E [mm]	F [mm]	
YT-1711	5	230	146	138	500	41	130x136	2
YT-1713	10	125	63	38	215	47	160x165	2

EN Two-piston hydraulic bottle jack
 PL Podnośnik hydrauliczny słupkowy dwutokowy
 DE Hydraulischer Stempelwagenheber
 RU Домкрат гидравлический
 CZ Pístový zvedák hydraulický
 HU Hidraulikus emelő
 RO Cric hidraulic
 FR Cric hydraulique bouteille
 IT Cric idraulico a bottiglia
 ES Gato hidráulico de botella
 CN 液压双级千斤顶



YATO 	[t]	A [mm]	B [mm]	C [mm]	D [mm]	E [mm]	F [mm]	G [mm]	
YT-1714	10	210	120	118	78	48	165x161	520	1
YT-1715	12	235	138	128	98	56	186x174.5	590	1

EN Hydraulic floor jack
PL Podnośnik hydrauliczny
DE Hydraulischer Rangierwagenheber
RU Домкрат гидравлический
CZ Pístový zvedák hydraulický
HU Krokodil emelő
RO Cric tip crocodil
FR Cric hydraulique
IT Sollevatore idraulico
ES Gato hidráulico
CN 卧式液压千斤顶

2t
359
89 mm



YATO 	[t]	
YT-1720	2	1

EN Hydraulic floor jack
PL Podnośnik hydrauliczny
DE Hydraulischer Rangierwagenheber
RU Домкрат гидравлический
CZ Pístový zvedák hydraulický
HU Krokodil emelő
RO Cric tip crocodil
FR Cric hydraulique
IT Sollevatore idraulico
ES Gato hidráulico
CN 卧式液压千斤顶

2.5t
508
80 mm
DUAL PUMP
PODWÓJNA
POMPA
QUICK LIFT
SZYBKE
PODNOŻENIE
LOW PROFILE
NISKI
PROFIL



YATO 	[t]	
YT-17207	2.5	1

EN Hydraulic floor jack
PL Podnośnik hydrauliczny
DE Hydraulischer Rangierwagenheber
RU Домкрат гидравлический
CZ Pístový zvedák hydraulický
HU Krokodil emelő
RO Cric tip crocodil
FR Cric hydraulique
IT Sollevatore idraulico
ES Gato hidráulico
CN 卧式液压千斤顶

3t
465
130 mm
LOW PROFILE
NISKI
PROFIL



YATO 	[t]	
YT-17211	3	1

EN Hydraulic floor jack
PL Podnośnik hydrauliczny
DE Hydraulischer Rangierwagenheber
RU Домкрат гидравлический
CZ Pístový zvedák hydraulický
HU Krokodil emelő
RO Cric tip crocodil
FR Cric hydraulique
IT Sollevatore idraulico
ES Gato hidráulico
CN 卧式液压千斤顶



3t
465
130 mm
DUAL PUMP
PODWÓJNA
POMPA
QUICK LIFT
SZYBKE
PODNOŻENIE
LOW PROFILE
NISKI
PROFIL

YATO 	[t]	
YT-17214	3	1

EN Hydraulic floor jack
PL Podnośnik hydrauliczny
DE Hydraulischer Rangierwagenheber
RU Домкрат гидравлический
HU Krokodil emelő
RO Cric tip crocodil
FR Cric hydraulique
IT Sollevatore idraulico
ES Gato hidráulico
CN 卧式液压千斤顶

2.5t
465
100 mm
DUAL PUMP
PODWÓJNA
POMPA
QUICK LIFT
SZYBKE
PODNOŻENIE
AI



ULTRA LIGHT 

YATO 	[t]	
YT-17205	2.5	1

EN Hydraulic floor jack
PL Podnośnik hydrauliczny
DE Hydraulischer Rangierwagenheber
RU Домкрат гидравлический
HU Krokodil emelő
RO Cric tip crocodil
FR Cric hydraulique
IT Sollevatore idraulico
ES Gato hidráulico
CN 卧式液压千斤顶

2.5t
455
87 mm



YATO 	[t]	
YT-1721	2.5	1

EN Hydraulic floor jack
PL Podnośnik hydrauliczny
DE Hydraulischer Rangierwagenheber
RU Домкрат гидравлический
CZ Pístový zvedák hydraulický
HU Krokodil emelő
RO Cric tip crocodil
FR Cric hydraulique
IT Sollevatore idraulico
ES Gato hidráulico
CN 卧式液压千斤顶

3t
500
145 mm



YATO 	[t]	
YT-17213	3	1

- EN Vehicle ramp
- PL Najazd samochodowy
- DE Auffahrttrappe
- RU Мини эстакада для автомобиля
- CZ Nájezd na auto
- HU Felhajtó rámpa
- RO Rampa auto
- FR Rampe pour voiture
- IT Rampa per veicoli
- ES Rampa para coches
- CN 运送顶

1 PC **1000** kg **815x305 x200** mm



- EN Wheel chock
- PL Klin pod koła
- DE Unterlegkeil
- RU Упор противоткатный
- CZ Klin pod kola
- HU Kerékkitámasztó ék
- RO Opritor roata
- FR Cale de roue
- IT Cuneo per ruote
- ES Calzo para ruedas
- CN 轮挡

220x110 x80 mm **max** **2500** kg **PP**

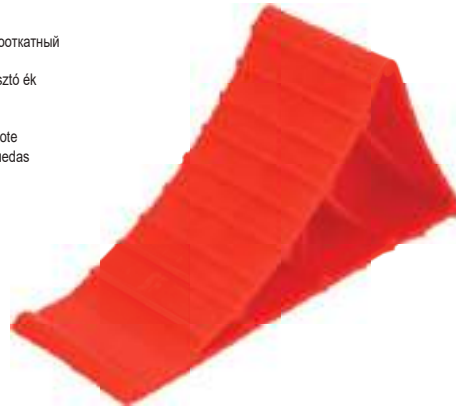

YATO	Dimensions / Wymiary [mm]	
YT-55670	815x305x200	10

YATO	Dimensions / Wymiary [mm]	
YT-55675	220x110x80	48

- EN Jack stand
- PL Podstawa pod samochód
- DE Unterstellbock
- RU Подставка автомобильная
- CZ Podstavec pod auto
- HU Gépkocsi alátét
- RO Capra auto
- FR Chandelle de voiture
- IT Cavalletto auto
- ES Caballete para auto
- CN 汽车安全支架

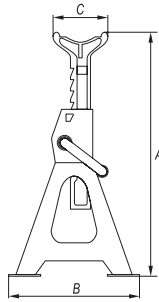

YATO	[t]	A [mm]	B [mm]	C [mm]	pcs / szt.	
YT-17310	2	265-415	190x165	77x40	2	1
YT-17311	3	280-420	182x201	85x29	2	1
YT-17312	6	388-580	258x285	100x29	2	1

- EN Porta power repair kit
- PL Rozpierał hydrauliczny
- DE Hydraulischer Richt und Ausbeulsatz
- RU Гидравлическая распорная стойка в наборе
- CZ Hydraulický rozpěrák
- HU Hidraulikus bontó

- RO Trusa pompa hidraulica + accesorii
- FR Porta puissance hydraulique
- IT Martinetto idraulico
- ES Gato carrocerro hidráulico
- CN 分离顶

4t

- EN Porta power repair kit
- PL Rozpierał hydrauliczny
- DE Hydraulischer Richt und Ausbeulsatz
- RU Гидравлическая распорная стойка в наборе
- CZ Hydraulický rozpěrák
- HU Hidraulikus bontó

- RO Trusa pompa hidraulica + accesorii
- FR Porta puissance hydraulique
- IT Martinetto idraulico
- ES Gato carrocerro hidráulico
- CN 分离顶

10t



Included: hydraulic cylinder 270x395 mm, expander jaws 0.5T, extensions 115, 170, 250, 470 mm
W zestawie: siłownik 270x395 mm, szczęki rozpieraka 0.5 t, przedłużki 115, 170, 250, 470 mm

YATO	[t]	
YT-55500	4	1



Included: hydraulic cylinder 355x495 mm, expander jaws 0.5T, extensions 140, 240, 340, 590 mm
W zestawie: siłownik 355x495 mm, szczęki rozpieraka 0.5 t, przedłużki 140, 240, 340, 590 mm

YATO	[t]	
YT-55503	10	1

EN Accessories for porta power
PL Pompa do rozpięka hydraulicznego
DE Druckeinheit für hydraulischer Spreizer
RU Ручной насос для гидравлической распорной стойки
CZ Pumpa na hydraulický rozpěrák
HU Szivattyú hidraulikus bontóhoz

RO Pompa hidraulica
FR Pompe hydraulique manuelle
IT Pompa per martinetto idraulico
ES Bomba hidraulica para gato carroceros
CN 分离顶油泵

4t



For YT-55512
Dla YT-55512

YATO	[t]	
YT-55510	4	1

EN Accessories for porta power
PL Siłownik do rozpięka hydraulicznego
DE Kraftzylinder für hydraulischer Spreizer
RU Сервомотор для гидравлической распорной стойки
CZ Servomotor na hydraulický rozpěrák
HU Erőátvitel a hidraulikus bontóhoz

RO Accesorii pompa hidraulica
FR Presse hydraulique de la pompe
IT Cilindro per martinetto idraulico
ES Cilindro para gato carroceros
CN 千斤顶

4t



For YT-55510
Dla YT-55510

YATO	[t]	
YT-55512	4	2

EN Electronic battery charger
PL Prostownik elektroniczny
DE Elektronisches Ladegerät
RU Электронное зарядное устройство
CZ Elektronická nabíječka
HU Elektronikus akkumulátortöltő

RO Redresor electric
FR Chargeur de batterie voiture
IT Avviatore elettronico
ES Cargador de batería para coche
CN 电池充电器

220-240V-50-60Hz
6V
12V
1 | 4
A

max 120 Ah
WET MOKRY
GEL ŻELOWY
AGM
MICRO-PROCESSOR
MIKRO-PROCESOR

LCD
ALTERNATOR TEST
ALTERNATORA
STARTER TEST
ROZRUSZNIKA

x1
HOOK HAK



YATO	
YT-83033	20

EN Accessories for porta power
PL Pompa do rozpięka hydraulicznego
DE Druckeinheit für hydraulischer Spreizer
RU Ручной насос для гидравлической распорной стойки
CZ Pumpa na hydraulický rozpěrák
HU Szivattyú hidraulikus bontóhoz

RO Pompa hidraulica
FR Pompe hydraulique manuelle
IT Pompa per martinetto idraulico
ES Bomba hidraulica para gato carroceros
CN 分离顶油泵

10t



For YT-55513
Dla YT-55513

YATO	[t]	
YT-55511	10	1

EN Accessories for porta power
PL Siłownik do rozpięka hydraulicznego
DE Kraftzylinder für hydraulischer Spreizer
RU Сервомотор для гидравлической распорной стойки
CZ Servomotor na hydraulický rozpěrák
HU Erőátvitel a hidraulikus bontóhoz

RO Accesorii pompa hidraulica
FR Presse hydraulique de la pompe
IT Cilindro per martinetto idraulico
ES Cilindro para gato carroceros
CN 千斤顶

10t



For YT-55511
Dla YT-55511

YATO	[t]	
YT-55513	10	2

EN Electronic battery charger
PL Prostownik elektroniczny
DE Elektronisches Ladegerät
RU Электронное зарядное устройство
CZ Elektronická nabíječka
HU Elektronikus akkumulátortöltő

220-240V-50Hz
6V
12V
2A
4A
max 200 Ah

WET MOKRY
GEL ŻELOWY
AGM/EFB
MICRO-PROCESSOR
MIKRO-PROCESOR
LCD

RO Redresor electric
FR Chargeur de batterie voiture
IT Avviatore elettronico
ES Cargador de batería para coche
CN 蓄电池充电器



YATO	
YT-83000	20

EN Electronic battery charger
 PL Prostownik elektroniczny
 DE Elektronisches Ladegerät
 RU Электронное зарядное устройство
 CZ Elektronická nabíječka
 HU Elektronikus akkumulátortöltő
 RO Redresor electric
 FR Chargeur de batterie voiture
 IT Avvitatore elettronico
 ES Cargador de batería para coche
 CN 蓄电池充电器

220-240V~ 50Hz	6V 12V	2A 8A	max 200 Ah	WET MOKRY GEL ZELOWY AGM / EFB	MICRO- PROCESSOR MKRO- PROCESOR	LCD	
-------------------	-----------	----------	------------------	--	--	-----	--



YATO **YT-83001** 20

EN Electronic battery charger
 PL Prostownik elektroniczny
 DE Elektronisches Ladegerät
 RU Электронное зарядное устройство
 CZ Elektronická nabíječka
 HU Elektronikus akkumulátortöltő
 RO Redresor electric
 FR Chargeur de batterie voiture
 IT Avvitatore elettronico
 ES Cargador de batería para coche
 CN 蓄电池充电器

220-240V~ 50Hz	6V 12V	2A 10A	max 200 Ah	WET MOKRY GEL ZELOWY AGM / EFB	MICRO- PROCESSOR MKRO- PROCESOR	LCD	
-------------------	-----------	-----------	------------------	--	--	-----	--



YATO **YT-83002** 12

EN Electronic battery charger
 PL Prostownik elektroniczny
 DE Elektronisches Ladegerät
 RU Электронное зарядное устройство
 CZ Elektronická nabíječka
 HU Elektronikus akkumulátortöltő
 RO Redresor electric
 FR Chargeur de batterie voiture
 IT Avvitatore elettronico
 ES Cargador de batería para coche
 CN 蓄电池充电器

220-240V~ 50Hz	12V	2A 8A 15A	max 200 Ah	WET MOKRY GEL ZELOWY AGM / EFB	MICRO- PROCESSOR MKRO- PROCESOR	LCD	
-------------------	-----	-----------------	------------------	--	--	-----	--



YATO **YT-83003** 8

EN Battery charger with boost function
 PL Prostownik z funkcją wspomagania ładowania
 DE Ladegerät mit Boost-Funktion
 RU Выпрямитель с функцией поддержки зарядки
 CZ Nabíječka s funkcí boost
 HU Akkumulátortöltő boost funkció
 RO Redresor baterie cu funcție boost
 FR Chargeur de batterie voiture support boost
 IT Caricabatterie con funzione boost
 ES Cargador de baterías con función boost
 CN 充电器启动机

220-240V~ 50-60Hz	12V	15A	max 300 Ah	WET MOKRY GEL ZELOWY AGM / EFB / MF	MICRO- PROCESSOR MKRO- PROCESOR	LED DISPLAY WYSWETLACZ	
----------------------	-----	-----	------------------	---	--	------------------------------	--



YATO **YT-83037** 8

EN Battery charger with boost function
 PL Prostownik z funkcją wspomagania ładowania
 DE Ladegerät mit Boost-Funktion
 RU Выпрямитель с функцией поддержки зарядки
 CZ Nabíječka s funkcí boost
 HU Akkumulátortöltő boost funkció
 RO Redresor baterie cu funcție boost
 FR Chargeur de batterie voiture support boost
 IT Caricabatterie con funzione boost
 ES Cargador de baterías con función boost
 CN 充电器启动机

230V~ 50Hz	12V 24V	16A	120-240 Ah	WET MOKRY	
---------------	------------	-----	---------------	--------------	--



YATO **YT-8304** 2

EN Battery charger with boost function
 PL Prostownik z funkcją wspomagania ładowania
 DE Ladegerät mit Boost-Funktion
 RU Выпрямитель с функцией поддержки зарядки
 CZ Nabíječka s funkcí boost
 HU Akkumulátortöltő boost funkció
 RO Redresor baterie cu funcție boost
 FR Chargeur de batterie voiture support boost
 IT Caricabatterie con funzione boost
 ES Cargador de baterías con función boost
 CN 充电器启动机

230V~ 50Hz	12V 24V	25 A	170-350 Ah	WET MOKRY	
---------------	------------	---------	---------------	--------------	--



YATO **YT-8305** 2

EN Battery charger with boost function
 PL Prostownik z funkcją wspomagania ładowania
 DE Ladegerät mit Boost-Funktion
 RU Выпрямитель с функцией поддержки зарядки
 CZ Nabíječka s funkcí boost
 HU Akkumulátortöltő boost funkció

RO Redresor baterie cu funcție boost
 FR Chargeur de batterie voiture support boost
 IT Caricabatterie con funzione boost
 ES Cargador de baterías con función boost
 CN 充电器启动机

230V~ 50Hz	12V 24V	15A	12 V 75 A BOOST ROZRUCH	WET MOKRY GEL ZELOWY AGM	MICRO- PROCESSOR MKRO- PROCESOR	
10-300 Ah						



YATO **YT-83051** 2

EN Battery charger with boost function
 PL Prostownik z funkcją wspomagania ładowania
 DE Ladegerät mit Boost-Funktion
 RU Выпрямитель с функцией поддержки зарядки
 CZ Nabíječka s funkcí boost
 HU Akkumulátortöltő boost funkció

RO Redresor baterie cu funcție boost
 FR Chargeur de batterie voiture support boost
 IT Caricabatterie con funzione boost
 ES Cargador de baterías con función boost
 CN 充电器启动机

230V~ 50Hz	12V 24V	30A	12 V 145 A BOOST ROZRUCH	WET MOKRY GEL ZELOWY AGM	MICRO- PROCESSOR MKRO- PROCESOR	
50-600 Ah						



YATO **YT-83052** 2

EN Battery charger with engine start-up supporting function
PL Prostownik z funkcją wspomagania rozruchu
DE Ladegerät mit Starthilfe
RU Выпрямитель с функцией поддержки запуска
CZ Nabíječky s funkci startovani motoru
HU Akkumulátortöltő indító
RO Redresor cu funcția de pomire de sprijin
FR Chargeur de batterie voiture support demarrage
IT Caricabatterie carrellato con funzione di avviatore rapido
ES Cargador de baterías arrancador
CN 充电器启动机



230V~
50Hz
12V 27A
START / ROZRUCH
300A
24V 25A
START / ROZRUCH
240A
20-600
Ah
WET
MOKRY

EN Battery charger with engine start-up supporting function
PL Prostownik z funkcją wspomagania rozruchu
DE Ladegerät mit Starthilfe
RU Выпрямитель с функцией поддержки запуска
CZ Nabíječky s funkci startovani motoru
HU Akkumulátortöltő indító
RO Redresor cu funcția de pomire de sprijin
FR Chargeur de batterie voiture support demarrage
IT Caricabatterie carrellato con funzione di avviatore rapido
ES Cargador de baterías arrancador
CN 充电器启动机



230V~
50Hz
12V 32A
START / ROZRUCH
390A
24V 31A
START / ROZRUCH
360A
20-700
Ah
WET
MOKRY

EN Battery charger with engine start-up supporting function
PL Prostownik z funkcją wspomagania rozruchu
DE Ladegerät mit Starthilfe
RU Выпрямитель с функцией поддержки запуска
CZ Nabíječky s funkci startovani motoru
HU Akkumulátortöltő indító
RO Redresor cu funcția de pomire de sprijin
FR Chargeur de batterie voiture support demarrage
IT Caricabatterie carrellato con funzione di avviatore rapido
ES Cargador de baterías arrancador
CN 充电器启动机



230V~
50Hz
12V 38A
START / ROZRUCH
540A
24V 35A
START / ROZRUCH
450A
20-800
Ah
WET
MOKRY

YATO
YT-83060 1

YATO
YT-83061 1

YATO
YT-83062 1

EN Jump starter with power bank
PL Urządzenie rozruchowe wielofunkcyjne
DE Multifunktions-Startgerät
RU Портативное пуско-зарядное устройство
CZ Multifunkční startovací zdroj a powerbanka
HU Többfunkciós autóindító
RO Acumulator extern pt. pomire motor si incarcare
FR Démarreur de saut de voiture multifonctionnel
IT Avviatore portatile multifunzione
ES Arrancador de batería multifuncional para coche
CN 应急电源

FRONT LIGHT / LAMPKA
7500 mAh
2 h
SILENT CHARGING / CICHEŁE ŁADOWANIE
Li-Po-Li
200 A
400 A
PEAK / SZCZYT
USB
5V / 2A
JUMP STARTER / ROZRUCH SILNIKA



YATO
YT-83080 20

EN Jump starter with power bank
PL Urządzenie rozruchowe wielofunkcyjne
DE Multifunktions-Startgerät
RU Портативное пуско-зарядное устройство
CZ Multifunkční startovací zdroj a powerbanka
HU Többfunkciós autóindító
RO Acumulator extern pt. pomire motor si incarcare
FR Démarreur de saut de voiture multifonctionnel
IT Avviatore portatile multifunzione
ES Arrancador de batería multifuncional para coche
CN 应急电源

FRONT LIGHT / LAMPKA
9000 mAh
3 h
SILENT CHARGING / CICHEŁE ŁADOWANIE
Li-Po-Li
200 A
400 A
PEAK / SZCZYT
12V
3.5A
OUTPUT / WYŚCIE
USB
5V / 2A
JUMP STARTER / ROZRUCH SILNIKA



YATO
YT-83081 10

EN Jump starter with power bank
PL Urządzenie rozruchowe wielofunkcyjne
DE Multifunktions-Startgerät
RU Портативное пуско-зарядное устройство
CZ Multifunkční startovací zdroj a powerbanka
HU Többfunkciós autóindító
RO Acumulator extern pt. pomire motor si incarcare
FR Démarreur de saut de voiture multifonctionnel
IT Avviatore portatile multifunzione
ES Arrancador de batería multifuncional para coche
CN 应急电源



FRONT LIGHT / LAMPKA
3.7 V
12000mAh
Li-Ion-Li
300 A
500 A
PEAK / SZCZYT
USB
5V/2.4A
19V
3.5A
OUTPUT / WYŚCIE
12V
INPUT / WEŚCIE
4h
12000mAh
LCD
JUMP STARTER / ROZRUCH SILNIKA



YATO
YT-83082 10

EN Jump starter with power bank
 PL Urządzenie rozruchowe wielofunkcyjne
 DE Multifunktions-Startgerät
 RU Портативное пуско-зарядное устройство
 CZ Multifunkční startovací zdroj a powerbanka
 HU Többfunkciós autóindító
 RO Acumulator extern pt. pomire motor si incarcare
 FR Démarreur de saut de voiture multifonctionnel
 IT Avviatore portatile multifunzione
 ES Arrancador de batería multifuncional para coche
 CN 应急电源



10W	S.O.S. FRONT LIGHT LATARNA	3.7 V 16000mAh Li-Ion	USB 5V/2.1A	USB 9V/2A	12V 8A OUTPUT WYŚCIE
4h	16000mAh	LCD	JUMP STARTER ROZRUCH SILNIKA	USB	USB 3.0
USB	USB BATTERY CHARGER ŁADOWNIA	Car	Motorcycle	Truck	Tractor
Smartphone	Tablet	MP3	Camera	Box	



YATO YT-83085 10

EN Power inverter
 PL Przetwornica napięcia
 DE Spannungswandler
 RU Автомобильный инвертор
 CZ Měníč napětí
 HU Feszültség átalakító
 RO Convertor de tensiune
 FR Convertisseur de tension
 IT Inverter di corrente
 ES Convertidor de voltaje
 CN 逆变器

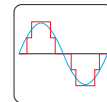

MODIFIED SINE WAVE SINUSOIDA MODYFIKOWANA

12V INPUT / WEŚCIE	220-240V-50 Hz OUTPUT / WYŚCIE	THERMAL PROTECTION ZABEZPIECZENIE TERMICZNE	LOW VOLTAGE LEVEL SIGNAL SIGNAL NISZKIEGO POZIOMI NAPIĘCIA	Box
--------------------	--------------------------------	---	--	-----



500 W
1000 W
PEAK / SZCZYT

800 W
1600 W
PEAK / SZCZYT



YATO YT-81490 12

YATO YT-81491 12

EN Jumpstart wires
 PL Przewody rozruchowe
 DE Starterkabel
 RU Пусковые провода
 CZ Startovací kabely
 HU Indító kábelek
 RO Cabluri demarare
 FR Câbles de démarrage
 IT Cavi carica batteria
 ES Cables de arranque
 CN 输出线

2.5m



YATO [A] YT-83151 200 10

YATO [A] YT-83152 400 10

YATO [A] YT-83153 600 10

EN Analogue battery tester
 PL Tester akumulatorów analogowy
 DE Analoges Batterieprüfgerät
 RU Аналоговый тестер аккумуляторов
 CZ Analogový tester akumulátorů
 HU Analóg akkuteszter
 RO Tester acumulatori analog
 FR Testeur de charge batterie
 IT Tester analogico per batteria
 ES Tester analógico para acumuladores
 CN 电池测试器

6V	12V
CCA 200-1000 A	Box



YATO YT-8310 10

EN Digital battery tester
 PL Tester akumulatorów cyfrowy
 DE Digitales Batterieprüfgerät
 RU Цифровой тестер аккумуляторов
 CZ Digitální tester autobaterií
 HU Digitális akkuteszter
 RO Tester acumulatori digital
 FR Testeur de batterie digital
 IT Tester digitale per batteria
 ES Comprobador de baterías digital
 CN 电池测试器

12V	CCA 150-1400 A
LED DISPLAY WYŚWIETLACZ	Box



YATO YT-8311 10

EN Battery tester
 PL Tester akumulatorów
 DE Batterieprüfgerät
 RU Тестер аккумуляторов
 CZ Tester akumulátorů
 HU Akkuteszter
 RO Tester acumulatori
 FR Testeur de batterie
 IT Tester per batteria
 ES Tester para acumuladores
 CN 电池测试器

12V	BATTERY TEST TEST AKUMULATORA
ALTERNATOR TEST TEST ALTERNATORA	Box



YATO YT-83101 12/72

EN Digital battery tester
PL Elektroniczny tester akumulatorów
DE Elektronischer Batterietester
RU Электронный тестер аккумуляторов
CZ Digitální tester autobaterií
HU Elektronikus akkumulátor teszter
RO Tester electronic acumulatori
FR Testeur de batterie électronique
IT Tester elettronico per batterie
ES Comprobador electrónico de baterías
CN 电池检测仪



YATO
YT-83113

 6/48

EN Digital battery tester
PL Elektroniczny tester akumulatorów
DE Elektronischer Batterietester
RU Электронный тестер аккумуляторов
CZ Digitální tester autobaterií
HU Elektronikus akkumulátor teszter
RO Tester electronic acumulatori
FR Testeur de batterie électronique
IT Tester elettronico per batterie
ES Comprobador electrónico de baterías
CN 电池检测仪



YATO
YT-83114

 56

EN OBD2 multilingual scan tool
PL Tester diagnostyczny OBD2
DE OBD2-Diagnosegerät
RU Диагностический тестер OBD2
CZ Diagnostický tester OBD2
HU OBD2 hibakód olvasó teszter
RO Tester diagnoza auto OBD2
FR Appareil de diagnostic OBD2
IT Strumento diagnostico OBD2
ES Comprobador de diagnóstico OBD2
CN 多语言汽车读码卡



YATO
YT-72977

 10/60

EN OBD2 multilingual scan tool
PL Tester diagnostyczny OBD2
DE OBD2-Diagnosegerät
RU Диагностический тестер OBD2
CZ Diagnostický tester OBD2
HU OBD2 hibakód olvasó teszter
RO Tester diagnoza auto OBD2
FR Appareil de diagnostic OBD2
IT Strumento diagnostico OBD2
ES Comprobador de diagnóstico OBD2
CN 多语言汽车读码卡



YATO
YT-72978

 40

EN Injector tester scan tool
PL Elektroniczny tester wtryskiwaczy silników benzynowych
DE Elektronisches Benzin-Einspritzdüsen-Prüfgerät
RU Электронный тестер для инжекторов бензинового двигателя
CZ Elektronický tester trysky benzinového motoru
HU Elektromos teszter benzinmotor befecskendezőhöz
RO Tester scanare injectoare
FR Testeur électronique d'injecteurs de moteurs à essence
IT Tester elettronico per iniettori per motori a benzina
ES Probador electrónico para inyectores de motores de gasolina
CN 汽车喷油器测试仪



YATO
YT-72960

 8/48

EN Refractometer
PL Refraktometr
DE Refraktometer
RU Рефрактометр
CZ Refraktometr
HU Fagyálló fokoló
RO Refractometrul
FR Réfractomètre
IT Rifrattometro
ES Refractometro
CN 冰点仪



YATO
YT-06722

 25

- EN Auto retract electric cable reel
- PL Przedłużacz elektryczny na zwijaku automatycznym
- DE Elektro-Kabelaufroller mit automatischem Einzug
- RU Электрический удлинитель на автоматическом барабане
- CZ Elektrický prodlužovací kabel na automatickém navijáku
- HU Elektromos hosszabbító automatikus csévével
- RO Prelungitor electric retractabil
- FR Câble de rallonge électrique sur enrouleur automatique
- IT Prolunga elettrica con avvolgicavo automatico
- ES Prolongador eléctrico en enrollador automático
- CN 电卷管器



10 A ~250 V	CABLE H05VV-F KABEL	3G 1.5 mm ²	E
E/F	IP34	AUTO REWIND AUTOMATISCHES ZWINGEN	EASILY MOUNT EATWY MONTAZ
		x4 ANCHORS KOTWY	

P_{max} = 2500 W coiled
 P_{max} = 2500 W uncoiled
 P_{max} = 2500 W zwinięty
 P_{max} = 2500 W rozwinięty

YATO	L [m]	
YT-81220	10	4
YT-81221	20	2

- EN Chain block
- PL Wyciągarka łańcuchowa
- DE Kettenzug Flaschenzug
- RU Таль цепная
- CZ Zvedák řetězový
- HU Láncos csigasor emelő
- RO Scripete cu lant
- FR Treuil à chaîne
- IT Paranco a catena
- ES Cabría de cadena
- CN 三角手拉葫芦



3m

YATO	Max. load capacity / Maks. obciążenie [kg]	
YT-58950	500	1
YT-58951	1000	1
YT-58953	2000	1
YT-58954	3000	1
YT-58955	5000	1

- EN Rope winch
- PL Wyciągarka linowa
- DE Handseilwinde
- RU Канатная лебедка
- CZ Lanové vyťahovací zařízení
- HU Drótköteles csőrő
- RO Troliu cu cablu orizontal
- FR Treuil à corde
- IT Paranco a corda
- ES Cabría de cuerdas
- CN 绳索拉紧器



1000 daN 3m

YATO	Rope length / Długość liny [m]	Rope diameter / Średnica liny [mm]	
YT-5911	3	5	6

- EN Rope winch
- PL Wyciągarka linowa
- DE Handseilwinde
- RU Канатная лебедка
- CZ Lanové vyťahovací zařízení
- HU Drótköteles csőrő
- RO Troliu cu cablu orizontal
- FR Treuil à corde
- IT Paranco a corda
- ES Cabría de cuerdas
- CN 绳索拉紧器



1300 daN 3m

YATO	Rope length / Długość liny [m]	Rope diameter / Średnica liny [mm]	
YT-5913	3	5	6

- EN Rope winch
- PL Wyciągarka linowa
- DE Handseilwinde
- RU Канатная лебедка
- CZ Lanové vyťahovací zařízení
- HU Drótköteles csőrő
- RO Troliu cu cablu orizontal
- FR Treuil à corde
- IT Paranco a corda
- ES Cabría de cuerdas
- CN 绳索拉紧器



1500 daN 3m

YATO	Rope length / Długość liny [m]	Rope diameter / Średnica liny [mm]	
YT-5914	3	6	3

EN Transmission jack
PL Podnośnik skrzyni biegów
DE Hydraulische Getriebeheber
RU Домкрат для коробки передач
CZ Pojízdný zvedák motorů a převodovek
HU Sebességváltó emelő tartó
RO Cric cutii de viteza
FR Levage des moteurs et des boîtes de vitesses
IT Sollevatore scatola del cambio
ES Motor de transmisión telescópica
CN 坡道



max **500 kg**
1900 1100 mm
PRECISION VALVE
PRECYZYJNY ZAWÓR

EN Transmission jack
PL Podnośnik skrzyni biegów
DE Hydraulische Getriebeheber
RU Домкрат для коробки передач
CZ Pojízdný zvedák motorů a převodovek
HU Sebességváltó emelő tartó
RO Cric cutii de viteza
FR Levage des moteurs et des boîtes de vitesses
IT Sollevatore scatola del cambio
ES Motor de transmisión telescópica
CN 运送顶



max **500 kg**
1945 1140 mm
PRECISION VALVE
PRECYZYJNY ZAWÓR

YATO

YT-55601



1

YATO

YT-55600



1

EN Parts washer
PL Myjka warsztatowa
DE Teilwaschgerät
RU Стенд для очистки деталей
CZ Mýcí stůl na součástky
HU Alkatrészmosó
RO Cuva pt. spalat piese
FR Fontaine de nettoyage pièces
IT Idropulitrice per officina
ES Lavadora piezas mecánicas
CN 零件清洗机



230V~
50Hz

720x480
x260
mm

880
mm

80 L

10
l/min

FOR SOLVENT
WATER BASED
DO PLYNŃW
NA BAZIE WODY



EN Sandblasting cabinet
PL Piaskarka kabinowa
DE Sandstrahlkabine
RU Пескоструйная камера
CZ Pískovací box
HU Homokszóró kabin
RO Cabina de sablat
FR Cabine de sablage
IT Sabbiatrica a cabina
ES Cabina de chorro de arena
CN 喷砂机

230V~
50Hz

0.82
MPa

90 L

585x490
x490
mm

STANDARD



$L_{pA} = 93,5 \pm 3,0$ dB; $L_{wA} = 95,0 \pm 3,0$ dB; $a_{pA} = < 2,5$ m/s²

YATO

YT-55808



1

YATO

YT-55840



1

EN Nozzle for sandblaster cabinet
PL Dysze ceramiczne do piaskarki kabinowej
DE Keramikdüsen für Sandstrahlkabine
RU Керамические насадки для пескоструйной камеры
CZ Keramické trysky pro kabinový pískovací stroj
HU Kerámia fúvókák homokszóró kabinhoz
RO Duze pt. aparat de sablat
FR Buses en céramique pour cabine de sablage
IT Ugelli ceramicci per sabbiatrica a cabina
ES Boquillas de protección para cabinas de chorro de arena
CN 四件套喷嘴

4
PCS

4, 5,
6, 7
mm



For YT-55840
Dla YT-55840

YATO

Ø [mm]



YT-55844

4, 5, 6, 7

20/200

EN Protective films for sandblasting cabinet
PL Folie ochronne do piaskarki kabinowej
DE Schutzfolien für Sandstrahlkabine
RU Защитные пленки для пескоструйной камеры
CZ Ochranná fólie průzoru pro pískovací box
HU Védőfóliák a homokszóróhoz
RO Folie protecție pt. cabina de sablat
FR Film de protection pour cabine de sablage
IT Pellicola protettiva per cabina sabbiatrica
ES Películas de protección para cabinas de chorro de arena
CN 四片装保护片

4
PCS

410x300
mm



For YT-55840
Dla YT-55840

YATO

[mm]



YT-55845

410x300

50/100

EN Gloves for sandblasting cabinet
PL Rękawice do piaskarki kabinowej
DE Handschuhe für Sandstrahlkabine
RU Перчатки для пескоструйной камеры
CZ Rukavice do pískovacích boxů
HU Homokfúvó szekrényhez kesztyű
RO Manusi pt. cabina de sablat
FR Gants pour cabine de sablage
IT Guanti per cabina sabbiatrica
ES Guantes para cabinas de chorro de arena
CN 手套



For YT-55840
Dla YT-55840

YATO

YT-55846



25

EN Shop crane
 PL Żuraw warsztatowy
 DE Werkstattkran
 RU Кран подкатной гидравлический
 CZ Hydraulický jeřáb
 HU Motorkiemelő zsiráf

RO Girafa pt. scos motor
 FR Grue d'atelier
 IT Gru idraulica
 ES Grúa hidráulica para motores
 CN 吊机



1000
kg

6x  STEEL STAL



EN Shop crane
 PL Żuraw warsztatowy
 DE Werkstattkran
 RU Кран подкатной гидравлический
 CZ Hydraulický jeřáb
 HU Motorkiemelő zsiráf

RO Girafa pt. scos motor
 FR Grue d'atelier
 IT Gru idraulica
 ES Grúa hidráulica para motores
 CN 吊机



2000
kg

6x  STEEL STAL





YATO  **YT-55556**  1

YATO  **YT-55557**  1

EN Shop press
 PL Prasa hydrauliczna
 DE Hydraulische Werkstattpresse
 RU Гидравлический пресс
 CZ Hydraulický lis
 HU Hidraulikus prés

RO Presa hidraulic
 FR Presse hydraulique
 IT Pressa idraulica
 ES Prensa de hidráulica
 CN 压力机

12t

695
0
mm

400
mm



YATO  **YT-55580**  1

EN Shop press
 PL Prasa hydrauliczna
 DE Hydraulische Werkstattpresse
 RU Гидравлический пресс
 CZ Hydraulický lis
 HU Hidraulikus prés

RO Presa hidraulic
 FR Presse hydraulique
 IT Pressa idraulica
 ES Prensa de hidráulica
 CN 压力机

20t

695
0
mm

490
mm



YATO  **YT-55581**  1

EN Shop press
 PL Prasa hydrauliczna
 DE Hydraulische Werkstattpresse
 RU Гидравлический пресс
 CZ Hydraulický lis
 HU Hidraulikus prés

RO Presa hidraulic
 FR Presse hydraulique
 IT Pressa idraulica
 ES Prensa de hidráulica
 CN 压力机

30t

795
0
mm

520
mm



YATO  **YT-55582**  1

- EN Engine bar with support arm
- PL Belka z poprzeczką do podwieszania silnika
- DE Motorbrücke mit Tragarm
- RU Балка с перекладиной для подвески двигателя
- CZ Nosník s příčkou pro zavěšení motoru
- HU Motorfelfüggesztő gerenda
- RO Suport ridicare motor
- FR Poutre de support moteur avec barre transversale
- IT Ponte per motori con traversa
- ES Barra de soporte del motor con travesía
- CN 引擎支架





90-160 cm  max 320 kg 

YATO 
YT-55567  1

- EN Engine suspension beam
- PL Belka do podwieszenia silnika
- DE Aufnahmevorrichtung des Motors
- RU Балка для вывешивания двигателя
- CZ Nosník k zavěšení motoru
- HU Motorfelfüggesztő gerenda
- RO Grindă pt. suspendarea motorului
- FR Poutre de suspension de moteur
- IT Fascio sospensione del motore
- ES La viga para suspender el motor
- CN 引擎支架



150 cm  max 500 kg 

YATO 
YT-55568  1

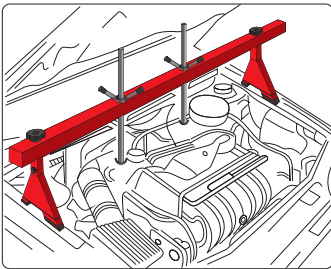

- EN Crane crossbeam
- PL Traverso do żurawia
- DE Traverse zum Kran
- RU Траверса для крана
- CZ Jířábová traverza
- HU Traverz a zsiráf emelőhöz
- RO Traversă pt. macara
- FR Balancier pour grue d'atelier
- IT Traversa per gru
- ES Viga transversal para grua
- CN 平衡器

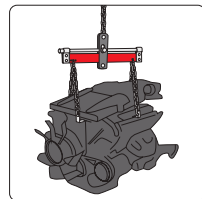



315 mm

max  680 kg



YATO 
YT-55565  1

- EN Engine stand
- PL Stojak do silnika
- DE Motorständer
- RU Стойка для ремонта двигателя
- CZ Stojan na motor
- HU Motorszerelő állvány
- RO Suport pt. motor
- FR Support moteur
- IT Cavalletto per motore
- ES Soporte de motor
- CN 发动机支架

max  450 kg  0-360°

4x  STEEL 



YATO 
YT-55570  1

EN Self locking nuts assortment
 PL Zestaw nakrętek metrycznych z zabezpieczeniem
 DE Sortiment Muttern metrisch mit Sicherheit
 RU Набор гаек самоконтращихся, с нейлоновой вставкой
 CZ Šestihranné matice s bezpečností
 HU Nuts metrikus menet biztonságási

RO Set piulițe autoblocante
 FR Hex écrou set avec la sécurité
 IT Set di autobloccanti metrica dadi
 ES Porcas rosca métrica con a seguridad
 CN 螺母组套

146
PCS

MIX

METRIC
METRYCZNY

INTERNAL
SECURITY
WENIETRZNE
ZABEZPIECZENIE



M4, M5, M6, M8, M10, M12

YATO YT-06774 5/20

EN Metric nuts assortment
 PL Zestaw nakrętek metrycznych
 DE Sortiment Muttern metrisch
 RU Набор гаек
 CZ Šestihranné matice
 HU Nuts metrikus menet

RO Set piulițe
 FR Hex écrou set
 IT Set di metrica dadi
 ES Porcas rosca métrica
 CN 螺母组套

300
PCS

MIX

METRIC
METRYCZNY

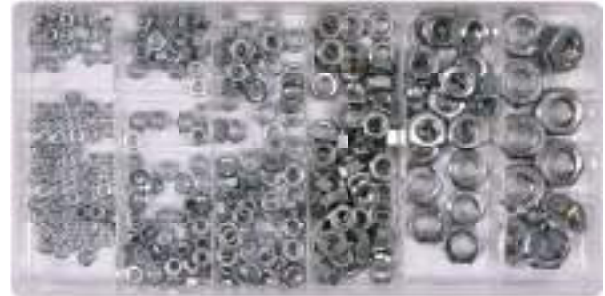

M3, M4, M5, M6, M8, M10

YATO YT-06772 5/20

EN Stainless steel nuts assortment
 PL Zestaw nakrętek metrycznych nierdzewnych
 DE Sortiment Muttern metrisch rostfrei
 RU Набор гаек шестигранных нержавеющей
 CZ Nerezové oceli šestihranné matice
 HU Nuts metrikus menet rozsdamentes

RO Set piulițe inox
 FR Hex écrou set inoxydable
 IT Set di acciaio inossidabile metrica dadi
 ES Rosca métrica tuercas inoxidable
 CN 螺母

300
PCS

MIX

METRIC
METRYCZNY

SS
STAINLESS STEEL
STAL NIERDZEWNA



M3, M4, M5, M6, M8, M10

YATO YT-06773 5/20

EN Hex nut with top assortment
 PL Zestaw nakrętek metrycznych kolpakowych
 DE Sortiment Muttern metrisch geschlossen
 RU Набор гаек колпачковых
 CZ Šestihranné matice zavřeno
 HU Nuts metrikus menet zárt

RO Set piulițe închise
 FR Hex écrou set fermé
 IT Set di dadi campana-metrica
 ES Rosca métrica tuercas cerrado
 CN 螺母

150
PCS

MIX

METRIC
METRYCZNY



M3, M4, M5, M6, M8, M10

YATO YT-06775 5/20

EN Metric wing nut assortment
 PL Zestaw nakrętek motylkowych
 DE Sortiment Flügelmuttern
 RU Набор гаек типа «барашек»
 CZ Křídlaté matice lisované
 HU Szárnyas anya

RO Set piulițe flutire
 FR Assortiment d'écrous papillon
 IT Set di metrica dadi
 ES Tuercas con orejas
 CN 蝶形螺母组套

150
PCS

MIX

METRIC
METRYCZNY



M4, M5, M6, M8, M10

YATO YT-06776 25

EN Aluminium washer set
 PL Zestaw podkładek aluminiowych
 DE Aluminium Dichttring Sortiment
 RU Набор алюминиевых шайб
 CZ Sada hliníkových podložek
 HU Réz alátét készlet

RO Set saibe aluminiu
 FR Assortiment de joints en aluminium
 IT Set di rondelle in alluminio
 ES Juego de cuñas de aluminio
 CN 铝垫片

300
PCS

MIX

METRIC
METRYCZNY



5x9x1.0 mm, 8x14x1.5 mm, 12x16x1.0 mm, 14x20x1.5 mm, 18x24x1.5 mm, 22x29x1.5 mm, 6x10x1.0 mm, 9x14x1.0 mm, 12x16x1.5 mm, 14x20x2.0 mm, 20x24.5x1.5 mm, 24x29x1.5 mm, 6x12x1.0 mm, 10x14x1.0 mm, 12x18x1.5 mm, 16x20x1.5 mm, 20x24.5x0.8 mm, 24x32x2.0 mm, 8x12x1.0 mm, 10x14x1.5 mm, 13x18x1.0 mm, 16x22x1.5 mm, 19x26x2.0 mm, 26x34x2.0 mm, 8x14x1.0 mm, 10x16x1.0 mm, 14x18x1.5 mm, 18x22x1.5 mm, 22x27x1.0 mm, 28x36x2.0 mm (x10 PCS)

YATO YT-06865 5/20

EN Aluminium washer set
PL Zestaw podkładek aluminiowych
DE Aluminium Dichttring Sortiment
RU Набор алюминиевых шайб
CZ Sada hliníkových podložek
HU Réz alátét készlet
RO Set saibe aluminiu
FR Assortiment de joints en aluminium
IT Set di rondelle in alluminio
ES Juego de cuñas de aluminio
CN 铝垫片

450
PCS

MIX

METRIC
METRYCZNY

AI



10x6x1.0 mm (40 PCS), 12x6x1.2 mm (40 PCS), 12x8x1.0 mm (40 PCS), 14x8x1.0 mm (40 PCS), 14x10x1.0 mm (40 PCS), 16x10x1.0 mm (40 PCS), 16x12x1.5 mm (20 PCS), 18x12x1.5 mm (20 PCS), 18x14x1.5 mm (20 PCS), 20x14x1.5 mm (20 PCS), 20x16x1.5 mm (20 PCS), 22x16x1.5 mm (20 PCS), 22x18x1.5 mm (20 PCS), 24x18x1.5 mm (20 PCS), 26x20x1.5 mm (20 PCS), 27x22x1.5 mm (10 PCS), 29x22x1.5 mm (10 PCS), 29x24x2.0 mm (10 PCS)

YATO

YT-068652



24

EN Drain plug gasket assortment
PL Zestaw podkładek do korków spustowych
DE Unterlegscheiben-Set für Ablassschrauben
RU Комплект шайб для сливных пробок
CZ Sada podložek pro vypouštění zátky
HU Leeresztöcsavar alátétkészlet

RO Set garnituri pt. scurgere
FR Rondelles de bouchon de vidange
IT Kit di rondelle per tappi di scarico
ES Juego de arandelas para tapones de descarga
CN 油底垫圈

120
PCS

MIX

NYLON

FIBER
WŁÓKNO

STEEL
STAL

AI

Cu

NBR



12x24.7x2 mm, 13.6x24.7x2 mm; Steel+NBR; 13x19x2.3 mm, 16x26x2.3 mm, 18x22x2.3 mm, 19x27x2.3 mm, 24x29x2.3 mm, 14.5x24x2 mm, 13x24x1.5 mm, 12x22x1.5 mm, 14x19.5x1.5 mm; Nylon; 12x22x1.5 mm, 18x28x2 mm, 20x27x1.5 mm, 13x22x2 mm, 14x20x1.5 mm; Fibre / Włókno; 13x18x1.2 mm, 16x22x1.5 mm, 20x26x2.5 mm, 14x20x1.3 mm; Cu; 14x24x2 mm; AI; 12x18x2 mm; Cu crush / Cu dmuchana; 12x20x2mm, 14x21x2.5mm; NBR; (x5 PCS)

YATO

YT-068641



12

EN Copper washer set
PL Zestaw podkładek miedzianych
DE Kupfer Dichttring Sortiment
RU Набор медных колец
CZ Podložky měděné těsnící
HU Réz tömítés készlet

RO Saibe din cupru
FR Patins en cuivre
IT Set di spessori
ES Arandelas de cobre
CN 紫铜垫片

220
PCS

MIX

SOFT MATERIAL
MIEKKI MATERIAL

Cu



4x8x1 mm, 5x9x1 mm, 6x10x1 mm, 6x12x1 mm (x25 PCS); 8x12x1 mm, 8x14x1 mm, 10x14x1 mm, 10x16x1 mm, 12x16x1.5 mm, 12x18x1.5 mm, 14x18x1.5 mm, 14x20x1.5 mm, 16x20x1.5 mm, 18x24x1.5 mm, 20x26x1.5 mm, 22x27x1.5 mm (x10 PCS)

YATO

YT-068721



24

EN Copper crush washer set
PL Zestaw podkładek miedzianych dmuchanych
DE Satz geblasener Kupfer-Passplatten
RU Комплект медных шайб
CZ Sada foukaných měděných podložek
HU Réz alátét készlet

RO Set saibe cupru
FR Jeu de rondelles en cuivre
IT Set di rondelle di rame soffiate
ES Conjunto de arandelas de cobre para tapón cárter
CN 铜环圈

95
PCS

MIX

Cu



8.4x12x1.8 mm (10 PCS), 10.4x15.8x2.0 mm (15 PCS), 12.4x17.8x2.2 mm (15 PCS), 14.4x19.8x2.2 mm (20 PCS), 16.4x21.8x2.0 mm (20 PCS), 18.2x23.8x2.2 mm (10 PCS), 20.2x25.8x2.2 mm (5 PCS)

YATO

YT-068713



24

EN Copper washer set
PL Zestaw podkładek miedzianych
DE Kupfer Dichttring Sortiment
RU Набор медных колец
CZ Podložky měděné těsnící
HU Réz tömítés készlet

RO Saibe din cupru
FR Patins en cuivre
IT Set di spessori
ES Arandelas de cobre
CN 紫铜垫片

150
PCS

MIX

Cu



5x10x1.0 mm, 6x10x1.0 mm, 7x10x1.0 mm, 8x11x1.0 mm, 10x16x1.0 mm, 10.5x17x1.5 mm, 11x17x1.5 mm, 14x18x1.0 mm, 12x20x1.5 mm, 12.5x20x1.5 mm, 14x20x1.5 mm, 15x20x2.0 mm, 16x22x2.0 mm, 16.5x24x2.0 mm, 17.5x24x2.0 mm (x10 PCS)

YATO

YT-06871



5/20

EN Copper washer set
PL Zestaw podkładek miedzianych
DE Kupfer Dichttring Sortiment
RU Набор медных колец
CZ Podložky měděné těsnící
HU Réz tömítés készlet

RO Saibe din cupru
FR Patins en cuivre
IT Set di spessori
ES Arandelas de cobre
CN 紫铜垫片

300
PCS

MIX

METRIC
METRYCZNY

Cu



5x9x1.0 mm, 8x14x1.5 mm, 12x16x1.0 mm, 14x20x1.5 mm, 18x24x1.5 mm, 22x29x1.5 mm, 6x10x1.0 mm, 9x14x1.0 mm, 12x16x1.5 mm, 14x20x2.0 mm, 20x24.5x1.5 mm, 24x29x1.5 mm, 6x12x1.0 mm, 10x14x1.0 mm, 12x18x1.5 mm, 16x20x1.5 mm, 20x24.5x0.8 mm, 24x32x2.0 mm, 8x12x1.0 mm, 10x14x1.5 mm, 13x18x1.0 mm, 16x22x1.5 mm, 19x26x2.0 mm, 26x34x2.0 mm, 8x14x1.0 mm, 10x16x1.0 mm, 14x18x1.5 mm, 18x22x1.5 mm, 22x27x1.0 mm, 28x36x2.0 mm (x10 PCS)

YATO

YT-06872



5/20

EN Copper washer set
 PL Zestaw podkładek miedzianych
 DE Kupfer Dichttring Sortiment
 RU Набор медных колец
 CZ Podložky měděné těsnící
 HU Réz tömítés készlet

RO Saibe din cupru
 FR Patins en cuivre
 IT Set di spessori
 ES Arandelas de cobre
 CN 紫铜垫片

580
PCS

MIX

Cu



4x8x1 mm, 4x9x1 mm, 7x10x1 mm, 8x12x1 mm, 6x12x1 mm, 8x14x1 mm, 10x16x1 mm, 11x17x1 mm, 10.5x17x1 mm, 12x16x1 mm (x30 PCS); 8x16x1 mm, 13x18x1 mm, 14x18x1 mm, 12x19x1 mm, 14x20x1 mm, 16x20x1 mm (x20 PCS); 17x21x1 mm, 17x23x1 mm, 18x22x1 mm, 18x24x1 mm (x15 PCS); 19x26x1 mm, 22x26x1 mm, 24x29x1 mm, 20x28x1 mm, 22x29x1 mm, 26x31x1 mm, 24x32x1 mm, 27x32x1 mm, 26x34x1 mm, 30x36x1 mm (x10 PCS)

YATO

YT-068711 20

EN Copper gasket & oil drain plug assortment
 PL Zestaw podkładek miedzianych i korków spustowych
 DE Ölablassschraube Kupfer Schrauben und O-Ringe
 RU Набор медных шайб и сливных пробок поддона двигателя
 CZ Sada měděných podložek a zátek pro olejové výpustě
 HU Olajteknő csavar és rézaláték készlet
 RO Set busoane baie ulei
 FR Boulons de carter d'huile & assortiment bagues
 IT Set di rondelle in rame a spine
 ES Tornillos y juntas para tapon de carter
 CN 油封

534
PCS

MIX

Cu



6 mm (50 PCS), 8 mm (50 PCS), 10 mm (50 PCS), 12 mm (50 PCS), 13 mm (50 PCS), 14 mm (50 PCS), 15 mm (50 PCS), 16 mm (50 PCS), 18 mm (50 PCS), 20 mm (50 PCS); M8x1.0 (5 PCS), M10x1.0 (5 PCS), M12x1.5 (5 PCS), M14x1.5 (5 PCS), M16x1.5 (3 PCS), M18x1.5 (3 PCS), M20x1.5 (3 PCS); G1/4 (5 PCS)

YATO

YT-06864 10

EN Aluminum gasket and oil drain plug assortment
 PL Zestaw podkładek aluminiowych i korków spustowych
 DE Alu-Unterlegscheiben- und Ölablassschrauben-Satz
 RU Набор алюминиевых подкладок и пробок
 CZ Sada hliníkových podložek a vypouštěcích zátek
 HU Alumínium alátét és leeresztőcsavar készlet
 RO Set garnituri al. si busoane baie ulei
 FR Jeu de rondelles et de bouchons de vidange en aluminium
 IT Kit di rondelle in alluminio e tappi di scarico
 ES Juego de arandelas de aluminio y tapones de descarga
 CN 油封

534
PCS

MIX

Al



6 mm (50 PCS), 8 mm (50 PCS), 10 mm (50 PCS), 12 mm (50 PCS), 13 mm (50 PCS), 14 mm (50 PCS), 15 mm (50 PCS), 16 mm (50 PCS), 18 mm (50 PCS), 20 mm (50 PCS); M10 (5 PCS), M12 (5 PCS), M13 (5 PCS), M14 (5 PCS), M15 (5 PCS), M16 (3 PCS), M18 (3 PCS), M20 (3 PCS)

YATO

YT-06862 12

EN Oil seal washer assortment
 PL Zestaw podkładek metalowo-gumowych
 DE Satz Metall- und Gummischeiden
 RU Набор металлорезиновых шайб
 CZ Sada podložek kov-guma
 HU Fém-gumi alátétkészlet

RO Set șaibe simeringuri
 FR Jeu de rondelles en métal et en caoutchouc
 IT Kit di rondelle in metallo et gomma
 ES Juego de arandelas metal goma
 CN 橡胶复合垫片

90
PCS

MIX

NBR70



M10x1.9 mm (20 PCS), M12x1.9 mm (20 PCS), M14x1.9 mm (20 PCS), M16x1.9 mm (10 PCS), M18x1.9 mm (5 PCS), M20x1.9 mm (5 PCS), M22x1.9 mm (5 PCS), M24x1.9 mm (5 PCS)

YATO

YT-068581 24

EN Oil seal washer assortment
 PL Zestaw podkładek metalowo-gumowych
 DE Satz Metall- und Gummischeiden
 RU Набор металлорезиновых шайб
 CZ Sada podložek kov-guma
 HU Fém-gumi alátétkészlet

RO Set șaibe simeringuri
 FR Jeu de rondelles en métal et en caoutchouc
 IT Kit di rondelle in metallo et gomma
 ES Juego de arandelas metal goma
 CN 橡胶复合垫片

150
PCS

MIX

NBR70



M6x1.0 mm (10 PCS), M8x1.9 mm (10 PCS), M10x1.9 mm (10 PCS), M12x1.9 mm (20 PCS), M14x1.9 mm (20 PCS), M16x1.9 mm (20 PCS), M18x1.9 mm (20 PCS), M20x1.9 mm (20 PCS), M22x1.9 mm (10 PCS), M24x1.9 mm (10 PCS)

YATO

YT-068582 24

EN Bodywork nuts & screws assortment
 PL Zestaw wkrętów i podkładek do karoserii
 DE Sortiment Karosseriemuttern mit Schrauben
 RU Набор саморезов и металлических клипс для кузовных работ
 CZ Tělo matice a šroub kit
 HU Karosszéria csavar és anya készlet

RO Set asamblare clema, holsuruburi
 FR Assortiment de vis et d'écrous cage
 IT Set viti e rondelle al corpo
 ES Body kit tornillo
 CN 螺丝组套

170
PCS

MIX



M3, M4, M5, M6;
 M3x8 mm, M4x16 mm, M5x12 mm, M6x20 mm

YATO

YT-06780 5/20

EN Clevis pin assortment
PL Zestaw sworzni z libem i otworem
DE Bolzen mit Kopf
RU Набор штифтов с отверстиями под шплинт
CZ Čepy s hlavou
HU Csapszeget kit

RO Set bolturi pt. securizare
FR Axe de chape
IT Set di perni con testa e il foro
ES Kit de pasador de horquilla
CN 销柱

60
PCS

∅
5-12
mm

MIX 



 5x25 mm, 6x25 mm, 6x30 mm, 6x40 mm, 6x45 mm, 6x50 mm, 6x60 mm, 6x65 mm, 8x25 mm, 8x30 mm, 8x40 mm, 8x45 mm, 8x50 mm, 8x60 mm, 8x65 mm, 8x70 mm, 10x25 mm, 10x40 mm, 10x50 mm, 12x40 mm, 12x50 mm

YATO  
YT-06786 4/16

EN Spring assortment
PL Zestaw sprężynek
DE Schraubenfeder Sortiment
RU Набор пружинок оцинкованных
CZ Sada pružin
HU Rugó készlet

RO Arcuri tensiune
FR Assortiment ressorts
IT Set di molle
ES Caja surtido de de resortes
CN 弹簧组套

200
PCS

MIX 



4.0x79.5 mm (12 PCS), 4.5x44.5 mm (8 PCS), 5.0x20.5 mm (10 PCS), 5.5x17.5 mm (10 PCS), 5.5x25.5 mm (10 PCS), 5.5x38.0 mm (10 PCS), 6.5x10.0 mm (10 PCS), 6.5x22.0 mm (10 PCS), 7.0x12.5 mm (10 PCS), 7.0x19.0 mm (10 PCS), 7.0x38.0 mm (10 PCS), 7.0x51.0 mm (12 PCS), 8.0x28.5 mm (8 PCS), 8.0x31.5 mm (10 PCS), 8.0x44.5 mm (12 PCS), 8.5x36.5 mm (10 PCS), 8.5x47.0 mm (12 PCS), 9.0x35.0 mm (8 PCS), 9.5x16.0 mm (6 PCS), 9.5x19.0 mm (12 PCS)

YATO  
YT-06875 5/20

EN Hitch pin assortment set
PL Zestaw zawleczek sprężystych
DE Federsplinte Sortiment
RU Набор шплинтов с фиксацией
CZ Pružinové závlačky
HU Rugós csap

RO Set sigurante securizare
FR Assortiment goupilles beta
IT Set di spine elastiche
ES Pasadores surtido beta
CN R型销

150
PCS

6
SIZES
ROZMIAR





 2.0x33 mm, 2.0x40 mm, 2.4x31 mm, 2.8x42 mm, 3.5x45 mm, 4.0x75 mm

YATO  
YT-06883 6/24

EN Grease nipple set
PL Zestaw smarowniczek
DE Schmiernippel
RU Набор масленок
CZ Sady mazacích hlavic
HU Zsírógomb (zsírözéfej) készlet

RO Set gresoare metalice
FR Set de graisseurs métriques
IT Set grasso capezzoli
ES Engrasador
CN 黄油嘴组套

110
PCS

METRIC
METRYCZNY 



M6x1 (60 PCS), M6x1 45° (5 PCS), M6x1 90° (5 PCS), M8x1 (10 PCS), M8x1 45° (5 PCS), M8x1 90° (5 PCS), M10x1 (10 PCS), M10x1 45° (5 PCS), M10x1 90° (5 PCS)

YATO  
YT-06888 5/20

EN Aluminium rivet assortment
PL Zestaw aluminiowych nitów zrywalnych
DE Aluminium Blindnieten Sortiment
RU Набор закленок
CZ Sada hliníkové nity
HU Csöves alumínium szegecsek

RO Set popniture
FR Rivets tubulaires en aluminium
IT Set di rivetto alluminio
ES Remaches tubulares de aluminio
CN 铆钉

400
PCS

MIX 

AI 



 2, 4, 3, 2, 4, 0, 4, 8 mm

YATO  
YT-36420 5/20

EN Splint pin assortment
PL Zestaw zawleczek prostych
DE Splinte Sortiment
RU Набор шплинтов
CZ Set závlačky
HU Sasszeg készlet

RO Cuie spintecate mici
FR Goupilles - goupille fendue
IT Set di perni
ES Dividir cotter pinos
CN 开口销

555
PCS

MIX 



 1.6x25 mm, 2.4x25 mm, 2.4x38 mm, 3.2x32 mm, 3.2x50 mm, 4.0x64 mm

YATO  
YT-06873 5/10

EN Splint pin assortment
 PL Zestaw zawleczek prostych
 DE Splinte Sortiment
 RU Набор шплинтов
 CZ Set závlačky
 HU Saszeg készlet

RO Cuie spintecate mici
 FR Goupilles - goupille fendue
 IT Set di perni
 ES Dividir cotter pinos
 CN 开口销组套

1000
 PCS
 MIX



1.5x25 mm, 2.4x25 mm, 2.4x38 mm, 3.0x32 mm, 3.0x50 mm, 4.0x60 mm

YATO
 YT-06885 6/12

EN E-ring circlips assortment
 PL Zestaw zawleczek typu „E”
 DE E-Sicherungsringe Sortiment
 RU Набор Э-образных стопорных колец
 CZ Otevření pojistný kroužek
 HU „E” kiip választék készlet

RO Set inele de siguranta tip „E”
 FR „E” clip assortment kit
 IT Set di spine tipo „E”
 ES E-ring anillo de retención variedad
 CN 卡簧

300
 PCS
 1.5-22
 mm



1.5 mm, 3 mm, 5 mm, 6 mm, 10 mm, 12 mm, 15 mm, 19 mm, 22 mm

YATO
 YT-06884 25

EN Metal tiller tin pin assortment
 PL Zestaw zawleczek i sworzni z lbem i otworami
 DE Set Splinte und Bolzen mit Kopf und Löchern
 RU Набор шплинтов и болтов с головкой и отверстиями
 CZ Sada závlaček a šroubů s hlavou a otvory
 HU Saszeg és fejes, nyílásos csaszeg készlet

RO Set bolturi cu sigurante
 FR Jeu de goupilles et d'axes avec têtes et des trous
 IT Kit di copiglie e perni con testa e fori
 ES Juego de pasadores y pernos con cabeza y aberturas
 CN 八孔销

56
 PCS
 8-13
 mm
 MIX



8x50 mm (5 PCS), 9.5x50 mm (15 PCS), 11x64 mm (5 PCS), 13x50 mm (3 PCS), Pins / Zawleccki: 2x30 mm (5 PCS), 2.5x40 mm (15 PCS), 2.5x40 mm (5 PCS), 3x44 mm (3 PCS)

YATO
 YT-06874 20

EN Axle wave washer assortment
 PL Zestaw zabezpieczeń osiowych sprężystych
 DE Axialer Federschutzsatz
 RU Замок осевой пружинный
 CZ Sada axiálních pružinových závlaček
 HU Rugós tengelybiztosító gyűrű

RO Set saibe axe
 FR Jeu de protections axiaux à ressorts
 IT Kit di protezioni assiali a molla
 ES Juego de sujeciones rápidas elásticas para ejes
 CN 轴承夹片

260
 PCS
 65Mn



M3x10 mm (30 PCS), M4x11.5 mm (30 PCS), M5x14 mm (40 PCS), M6x16 mm (50 PCS), M8x18 mm (50 PCS), M10x20.5 mm (40 PCS), M12x26 mm (20 PCS)

YATO
 YT-06860 24

EN Linch-pins assortment
 PL Zestaw zawleczek z kółkiem
 DE Klappsplint Sortiment
 RU Набор шплинтов с кольцом
 CZ Kolik pojistný
 HU Rugos biztositoszeg készlet

RO Set pini pt. securizare
 FR Assortiment goupille clip
 IT Set di perni dalla ruota
 ES Pasador clip
 CN 弹性销组套

50
 PCS
 MIX



Ø 4.5x36 mm, Ø 6.0x45 mm, Ø 8.0x45 mm, Ø 11.0x45 mm

YATO
 YT-06787 6/12

EN Single ear hose clamp assortment
 PL Zestaw obejm zaciskowych z uchem
 DE 1-Ohr-Schellensatz
 RU Зажимы для шлангов с ушком
 CZ Jednoho ucha hadicové svorky
 HU Fűles szorítóbilincс készlet

RO Coliere metalice pt. furtun
 FR Jeu de colliers de serrage à oreille
 IT Set di fascette di fissaggio con orecchio
 ES Juego de abrazaderas de una oreja
 CN 卡箍套裝

170
 PCS
 MIX
 SS304
 STAINLESS STEEL
 STAL NIERDZEWNA



5.8-7 mm (20 PCS), 7.3-9 mm (20 PCS), 8.8-10.5 mm (20 PCS), 10.8-13.3 mm (20 PCS), 12-14.5 mm (20 PCS), 12.3-14.8 mm (20 PCS), 14.5-17 mm (20 PCS), 16-19.2 mm (15 PCS), 17.8-21 mm (15 PCS)

YATO
 YT-067842 24

EN Hose clamp assortment
PL Zestaw obejm ślimakowych
DE Schlauchschelle Sortiment
RU Набор хомутов
CZ Spony stahovac na hadice sada
HU Tömélbilincs csőszerelés szett

RO Coliere furtun
FR Colliers de serrage universels
IT Fascetta assortimento
ES Manguera helicoidal instalación de tuberías abrazadera conjunto
CN 喉箍

26
PCS

16-40
mm

MIX



16, 22, 25, 28, 35, 40 mm

YATO
YT-06782 5/20

EN Steel and rubber hose clamps
PL Zestaw opasek zaciskowych metalowo-gumowych
DE Gummierter Schlauchschellen Sortiment
RU Хомуты сантехнические
CZ Kabelové přichytky s gumou
HU Gumbetétes szorítóbilincs készlet

RO Coliere de furtun din otel si cauciuc
FR Colliers de serrage en métal et caoutchouc
IT Set di fascette di fissaggio di metallo e gomma
ES Abrazaderas con goma
CN 单耳卡箍套装

18
PCS

MIX

GALVANIZED
STEEL
STAL
GALWANIZOWANA



6 mm (8 PCS), 8 mm (4 PCS), 10 mm (2 PCS), 13 mm (2 PCS), 16 mm (2 PCS)

YATO
YT-067833 54

EN Double ear hose clamp assortment
PL Zestaw obejm zaciskowych z uszami
DE 2-Ohr-Schellensatz
RU Набор хомутов с проушинами
CZ Dvojitě ucho hadicové svorky
HU Fűlés szorítókészlet

RO Set cleme furtun
FR Jeu de serre-câbles à oreilles
IT Set di fascette di fissaggio con orecchie
ES Set de abrazaderas con orejetas
CN 双耳卡箍套装

175
PCS

MIX

GALVANIZED
STEEL
STAL
OCYNKOWANA



5-7 mm (25 PCS), 7-9 mm (25 PCS), 9-11 mm (25 PCS), 11-13 mm (20 PCS), 13-15 mm (20 PCS), 15-18 mm (20 PCS), 17-20 mm (15 PCS), 20-23 mm (15 PCS), 23-27 mm (10 PCS)

YATO
YT-06784 10

EN Hose clamp assortment
PL Zestaw obejm skręcanych do przewodów
DE Schlauchschellen-Set
RU Набор винтовых зажимов для кабелей
CZ Sada šroubovaných svorek do hadic
HU Vezetékbilincs készlet

RO Set coliere pt. furtun
FR Jeu de supports à visser pour conducteurs
IT Kit di clip fermacavi
ES Juego de abrazaderas atornillables para cables
CN 喉箍

30
PCS

MIX

6-16
mm



6-8 mm (7 PCS), 7-9 mm (7 PCS), 8-10 mm (5 PCS), 9-11 mm (5 PCS), 10-12 mm (3 PCS), 14-16 mm (3 PCS)

YATO
YT-06783 24

EN Steel and rubber hose clamps
PL Zestaw opasek zaciskowych metalowo-gumowych
DE Gummierter Schlauchschellen Sortiment
RU Хомуты сантехнические
CZ Kabelové přichytky s gumou
HU Gumbetétes szorítóbilincs készlet

RO Coliere de furtun din otel si cauciuc
FR Colliers de serrage en métal et caoutchouc
IT Set di fascette di fissaggio di metallo e gomma
ES Abrazaderas con goma
CN 单耳卡箍套装

52
PCS

MIX

SS304
STAINLESS STEEL
STAL NERDZAWNA



6 mm (12 PCS), 8 mm (10 PCS), 10 mm (10 PCS), 13 mm (8 PCS), 16 mm (8 PCS), 19 mm (4 PCS)

YATO
YT-067834 22

EN External / internal circlip assortment
PL Zestaw pierścieni Segera
DE Seeger-Sicherungsringe
RU Набор стопорных колец
CZ Sada vnitřní / vnější kroužky
HU Seeger gyűrű készlet

RO Set sigurante tip inel alezaj
FR Set de bagues Seeger
IT Set di anelli Seeger
ES Set de anillos Seeger
CN 卡簧

225
PCS

MIX





Internal / Wewnętrzne: Ø 11, 13, 14, 16, 19, 20 mm; External / Zewnętrzne: Ø 6, 8, 9, 11, 13, 14, 16, 19, 20, 22, 25, 32 mm

YATO
YT-06882 5/20

EN External circlip assortment
 PL Zestaw pierścieni Segera zewnętrznych
 DE Aussen-Seegerring Sortiment
 RU Набор стопорных колец
 CZ Sada pojistné kroužky
 HU Külső seeger-gyűrű készlet

RO Set sigurante tip inel alezaj
 FR Set de bagues Seeger
 IT Set di anelli Seeger
 ES Set de anillos Seeger
 CN 外置挡圈

300
PCS

Ø 3, 4, 5, 6, 8, 9, 11, 12, 13, 14, 15, 19, 20, 22, 25, 26, 28, 32 mm

YATO 

YT-06880  5/20

EN Feather key assortment
 PL Zestaw klinów do kół pasowych
 DE Keileset für Riemenscheiben
 RU Комплект клиньев для шкивов
 CZ Sada klínů pro vodící klady
 HU Szíjártásra ékkészlet

RO Set pene
 FR Jeu de cales pour poulies
 IT Set di linguette per pulegge
 ES Juego de cuñas de polea
 CN 平键

60
PCS

MIX



3x3x20 mm (4 PCS), 3x3x25 mm (4 PCS), 8x10x30 mm (5 PCS), 5x5x20 mm (5 PCS), 8x7x30 mm (5 PCS), 5x5x25 mm (5 PCS), 8x7x40 mm (5 PCS), 5x5x30 mm (5 PCS), 6x6x20 mm (5 PCS), 10x8x40 mm (5 PCS), 6x6x30 mm (5 PCS), 6x6x40 mm (5 PCS), 8x12x40 mm (2 PCS)

YATO 

YT-06793  24

EN Steel ball assortment
 PL Zestaw kulek stalowych
 DE Stahlkugeln-Set
 RU Набор стальных шариков
 CZ Sada ocelových kuliček
 HU Acél golyókészlet

RO Set bile pt. rulmenti
 FR Jeu de billes en acier
 IT Set di sfere d'acciaio
 ES Juego de bolas de acero
 CN 轴承钢珠组套

470
PCS

MIX

BEARING
 STEEL
 STAL
 ŁOŻYSKOWA

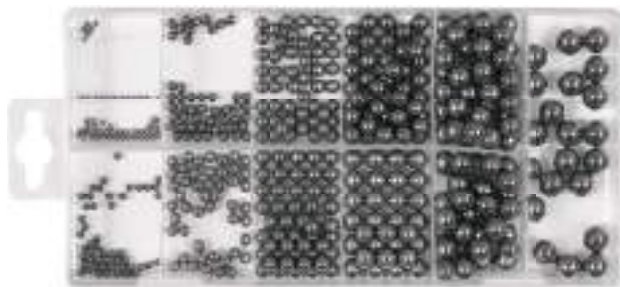
3/32" (2.4 mm, 50 PCS), 1/8" (3.2 mm, 50 PCS), 5/32" (4.0 mm, 50 PCS), 3/16" (4.8 mm, 50 PCS), 7/32" (5.6 mm, 50 PCS), 1/4" (6.3 mm, 50 PCS), 9/32" (7.1 mm, 50 PCS), 5/16" (7.9 mm, 30 PCS), 11/32" (8.7 mm, 50 PCS), 3/8" (9.5 mm, 20 PCS), 13/32" (10.3 mm, 20 PCS)



YATO 

YT-06680  5/20

EN Internal circlip assortment
 PL Zestaw pierścieni Segera wewnętrznych
 DE Innen-Seegerring Sortiment
 RU Набор стопорных колец
 CZ Sada pojistné kroužky
 HU Belső seeger-gyűrű készlet

RO Set sigurante tip inel alezaj
 FR Set de bagues Seeger
 IT Set di anelli Seeger
 ES Set de anillos Seeger
 CN 内置挡圈

300
PCS

Ø 3, 4, 5, 6, 8, 9, 11, 12, 13, 14, 15, 19, 20, 22, 25, 26, 28, 32 mm

YATO 

YT-06881  5/20

EN Feather keys assortment
 PL Zestaw klinów półokrągłych
 DE Sortiment Federkeile
 RU Шпонки полукруглые
 CZ Sada klínů polokruhových
 HU Ives hornyok biztosítására

RO Set pene disc pt. imbinari arbore
 FR Aspérule clés assortiment
 IT Set di cunei semicirculari
 ES Surtido de chavetas media luna
 CN 键销组套

80
PCS

MIX



3.0x5.0x13 mm, 3.0x6.5x16 mm, 4.0x5.0x13 mm, 4.0x6.5x16 mm, 4.0x7.5x19 mm, 5.0x7.5x19 mm, 5.0x9.0x22 mm, 6.0x9.0x22 mm

YATO 

YT-06790  5/20

EN Socket head set screw assortment metric
 PL Zestaw śrub imbusowych bez łba
 DE Sortiment Madenschrauben, metrisch
 RU Набор винтов установочных с плоским концом
 CZ Šroub stavěcí, plochý konec, bez úpravy
 HU Set menetes sasszegekkel

RO Set splituri fi letate
 FR Set clavettes de vis
 IT Set di viti esagonali senza testa
 ES Conjunto de tornillo chavelas
 CN 螺钉组套

160
PCS

MIX

METRIC
 METRYCZNY



3x5 mm, 4x5 mm, 5x6 mm, 6x6 mm, 6x6 mm F, 6x10 mm, 8x10 mm, 8x10 mm F, 8x12 mm, 10x10 mm, 10x10 mm F, 10x12 mm

YATO 

YT-06777  5/20

EN Rubber grommet assortment
PL Zestaw przelotek gumowych
DE Gummi-Durchgangs-Tullen Sortiment
RU Набор резиновых втулок
CZ Gumové průchočka
HU Gumi grommet készlet

RO Presetupa cauciuc pt. cablu
FR Coffret passe-cloison caoutchouc
IT Gommino angello
ES Caja surtido de pasamuros de goma
CN 墊圈組套

180
PCS

MIX

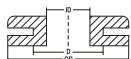

6.3 mm (D=6.3 mm, ID=3.0 mm, OD=8.0 mm; 40 PCS), 7.9 mm (D=7.9 mm, ID=5.0 mm, OD=10.0 mm; 40 PCS), 9.5 mm (D=9.5 mm, ID=6.0 mm, OD=13.0 mm; 40 PCS), 11 mm (D=11.0 mm, ID=9.0 mm, OD=15.0 mm; 25 PCS), 12.7 mm (D=12.7 mm, ID=11.0 mm, OD=15.0 mm; 20 PCS), 15.8 mm (D=15.8 mm, ID=12.0 mm, OD=19.0 mm; 5 PCS), 22 mm (D=22.0 mm, ID=15.0 mm, OD=26.0 mm; 5 PCS), 25.4 mm (D=25.4 mm, ID=17.0 mm, OD=32.0 mm; 5 PCS)

YATO

YT-06878



5/20

EN O-ring assortment
PL Zestaw O-ringów gumowych
DE O-Ring Sortiment
RU Набор резиновых прокладок
CZ Sada gumových o-kroužků
HU O gyűrű készlet

RO Garnituri din cauciuc
FR Set d'o-rings en caoutchouc
IT Set guarnizioni O-ring
ES Kit de junta tórica
CN O型圈組套

225
PCS

HEAT
RESISTANT
TEMPERATURE-
CORPORNE



3x1 mm (20 PCS), 4x1 mm (20 PCS), 4.5x2 mm (20 PCS), 5x2 mm (20 PCS), 6x2 mm (20 PCS), 6x2.5 mm (20 PCS), 6x3 mm (20 PCS), 7x2 mm (20 PCS), 8x2 mm (20 PCS), 9x2 mm (5 PCS), 10x2 mm (5 PCS), 12x3 mm (5 PCS), 13x3 mm (5 PCS), 14x2.5 mm (5 PCS), 17x2.5 mm (5 PCS), 18x4 mm (5 PCS), 20x2 mm (5 PCS), 22x2 mm (5 PCS)

YATO

YT-06877



5/20

EN O-Rings assortment for air conditioning
PL Zestaw O-ringów do klimatyzacji
DE O-Ring für Klimaanlage
RU Комплект прокладок для кондиционера
CZ Gumový kroužek set klimatizace
HU Gumi gyűrű készlet légkondicionálós

RO Inele pt. aer condiționat
FR Cercle en caoutchouc boîte de kit combinaison
IT O-Ring assortmento per l'aria condizionata
ES Kit de junta tórica
CN O型圈組套

270
PCS

MIX

HNBR



Ø 5.29x1.78 mm (20 PCS), Ø 6.07x1.78 mm (20 PCS), Ø 6.8x1.9 mm (20 PCS), Ø 7.65x1.78 mm (20 PCS), Ø 7.8x1.9 mm (20 PCS), Ø 8x2 mm (20 PCS), Ø 8.8x1.9 mm (20 PCS), Ø 10.82x1.78 mm (15 PCS), Ø 10.77x2.62 mm (15 PCS), Ø 11x2 mm (15 PCS), Ø 12x2 mm (15 PCS), Ø 13.9x1.8 mm (10 PCS), Ø 13.95x2.62 mm (10 PCS), Ø 10x2 mm (10 PCS), Ø 15x2 mm (10 PCS), Ø 17x2 mm (10 PCS), Ø 17.17x1.78 mm (10 PCS), Ø 17.04x3.53 mm (10 PCS)

YATO

YT-06879



6/24

EN Roll pin assortment
PL Zestaw kołków sprężystych
DE Hohlspannstifte Spannstifte Sortiment
RU Набор штифтов с пружиной
CZ Pružné válcové kolíky se štérbínou
HU Rugalmas hengeres csapok a nyílásba

RO Set splinturi elastice
FR Ressorts à rouleaux
IT Perno del rullo assortimento
ES Acero pasador elástico
CN 彈性銷

315
PCS

MIX



1.5x5 mm, 1.5x8 mm, 1.5x20 mm, 2x6 mm, 2x12 mm, 2x25 mm, 2.5x16 mm, 2.5x25 mm, 2.5x30 mm, 3x16 mm, 3x25 mm, 3x30 mm, 4x16 mm, 4x25 mm, 4x40 mm, 5x16 mm, 5x25 mm, 5x30 mm, 5.5x16 mm, 5.5x30 mm, 5.5x45 mm, 6x16 mm, 6x30 mm, 6x45 mm, 8x20 mm, 8x40 mm, 8x50 mm, 10x20 mm, 10x40 mm, 10x50 mm

YATO

YT-06785



5/20

EN O-Rings assortment for air conditioning
PL Zestaw O-ringów do klimatyzacji
DE O-Ring für Klimaanlage
RU Комплект прокладок для кондиционера
CZ Gumový kroužek set klimatizace
HU Gumi gyűrű készlet légkondicionálós

RO Inele pt. aer condiționat
FR Cercle en caoutchouc boîte de kit combinaison
IT O-Ring assortmento per l'aria condizionata
ES Kit círculo caucho combinación caja
CN 氯化丁晴密封圈

225
PCS

MIX

HNBR



3x1 mm (20 PCS), 4x1 mm (20 PCS), 4.5x2 mm (20 PCS), 5x2 mm (20 PCS), 6x2 mm (20 PCS), 6x2.5 mm (20 PCS), 6x3 mm (20 PCS), 7x2 mm (20 PCS), 8x2 mm (20 PCS), 9x2 mm (5 PCS), 10x2 mm (5 PCS), 12x3 mm (5 PCS), 13x3 mm (5 PCS), 14x2.5 mm (5 PCS), 17x2.5 mm (5 PCS), 18x4 mm (5 PCS), 20x2 mm (5 PCS), 22x2 mm (5 PCS)

YATO

YT-068791



5/20

EN O-ring assortment
PL Zestaw O-ringów gumowych
DE O-Ring Sortiment
RU Набор резиновых прокладок
CZ Sada gumových o-kroužků
HU O gyűrű készlet

RO Garnituri din cauciuc
FR Set d'o-rings en caoutchouc
IT Set guarnizioni O-ring
ES Kit de junta tórica
CN O型圈

419
PCS

MIX

NBR

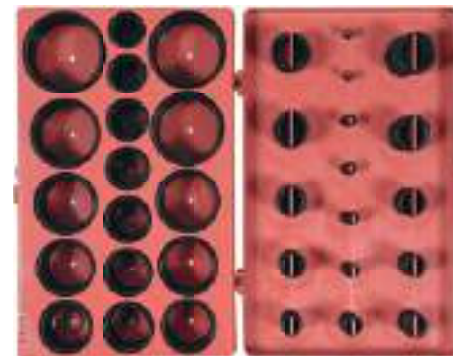

3x1.5 mm, 4.4x2 mm, 5x2 mm, 7x1.5 mm, 10x1.5 mm, 10x2.5 mm, 11x2.5 mm, 13x1.5 mm, 13x2.5 mm, 14x2.5 mm, 16x2.5 mm, 18x2.5 mm, 19x2.5 mm, 21x2.5 mm, 22x2.5 mm, 18x3.5 mm, 20x3.5 mm, 22x3.5 mm, 23.5x3.5 mm, 25x3.5 mm, 26.5x3.5 mm, 28x3.5 mm, 30x3.5 mm, 31x3.5 mm, 33x3.5 mm, 34.5x3.5 mm, 36x3.5 mm, 38x3.5 mm, 41x3.5 mm, 44x3.5 mm, 47x3.5 mm, 50x3.5 mm

YATO

YT-06876



5/20

EN Electrical clip assortment
 PL Zestaw złącz elektrycznych - krokodyliki
 DE Krokodil-Klemmen-Koriment
 RU Набор разъемов - крокодил
 CZ Terminal alligator krokodil přichytek
 HU Krokodil csipesz készlet

RO Sortiment cleme crocodil
 FR Assortiment pinces crocodile
 IT Set di pemi per misure e prove
 ES Crocodile clip
 CN 夹头组套

28
PCS

MIX



50, 55, 60, 65, 70, 80 mm

YATO
YT-06870

5/20

EN Terminal assortment
 PL Zestaw złącz elektrycznych
 DE Kabelschuh-Set
 RU Набор электрических клемм
 CZ Sada elektrických konektorů
 HU Elektromos csatlakozókészlet

RO Set papuci auto
 FR Jeu de cosses de câbles
 IT Kit di connettori elettrici
 ES Juego de conectores eléctricos
 CN 接线端子

250
PCS

MIX



Connector blue male / Złącze niebieskie męskie: 6.4 mm (1.5-2.5mm; 50 PCS), Connector blue female / Złącze niebieskie żeńskie: 6.4 mm (1.5-2.5 mm; 50 PCS), Connector red male / Złącze czerwone męskie: 6.4 mm (0.5-1.5 mm; 50 PCS), Connector red female / Złącze czerwone żeńskie: 6.4 mm (0.5-1.5 mm; 50 PCS), Connector tube red / Złącze rurowe czerwone: (0.5-1.5 mm; 25 PCS), Connector tube blue / Złącze rurowe niebieskie: (0.5-1.5 mm; 25 PCS)

YATO
YT-06891

60

EN Terminal assortment
 PL Zestaw złącz elektrycznych
 DE Kabelschuh-Set
 RU Набор электрических клемм
 CZ Sada elektrických konektorů
 HU Elektromos csatlakozókészlet

RO Set papuci auto
 FR Jeu de cosses de câbles
 IT Kit di connettori elettrici
 ES Juego de conectores eléctricos
 CN 接线端子

360
PCS

MIX



⊖ Ø5 mm - 2 mm2 (30 PCS), Ø6 mm - 2 mm2 (20 PCS), Ø9.5 mm - 2 mm2 (20 PCS), Ø5 mm - 5.5 mm2 (20 PCS), Ø6 mm - 5.5 mm2 (15 PCS), Ø9.5 mm - 5.5 mm2 (15 PCS); ⊖ 2 mm2 (25 PCS); ⊖ 2 mm2 (35 PCS); ⊖ 2 mm2 (10 PCS); ⊖ 1.25 mm2 (40 PCS), 2 mm2 (30 PCS), 5.5 mm2 (15 PCS); ⊖ 2 mm2 (35 PCS); ⊖ Ø5 mm - 2 mm2 (30 PCS), Ø5 mm - 5.5 mm2 (20 PCS);

YATO
YT-06890

12

EN Terminal assortment
 PL Zestaw złącz elektrycznych
 DE Kabelschuh-Set
 RU Набор электрических клемм
 CZ Sada elektrických konektorů
 HU Elektromos csatlakozókészlet

RO Set papuci auto
 FR Jeu de cosses de câbles
 IT Kit di connettori elettrici
 ES Juego de conectores eléctricos
 CN 接线端子

160
PCS

MIX



⊖ Ø4 mm (8 PCS), Ø4 mm (10 PCS), Ø5 mm (4 PCS), Ø5 mm (10 PCS), Ø6 mm (10 PCS), Ø8 mm (4 PCS), Ø10 mm (4 PCS); ⊖ 0.25-1.5 mm2 (12 PCS), 1.5-2.5 mm2 (18 PCS), 4-6 mm2 (12 PCS); ⊖ Ø4 mm (10 PCS); ⊖ 1.5-2.5 mm2 (10 PCS); ⊖ 1.5-2.5 mm2 (10 PCS), 4-6 mm2 (5 PCS); ⊖ 1.5-2.5 mm2 (10 PCS), 4-6 mm2 (5 PCS); ⊖ 0.25-1.5 mm2 (4 PCS), 1.5-2.5 mm2 (4 PCS)

YATO
YT-06891

24

EN Terminal assortment
 PL Zestaw złącz elektrycznych
 DE Kabelschuh-Set
 RU Набор электрических клемм
 CZ Sada elektrických konektorů
 HU Elektromos csatlakozókészlet

RO Set papuci auto
 FR Jeu de cosses de câbles
 IT Kit di connettori elettrici
 ES Juego de conectores eléctricos
 CN 接线端子

240
PCS

MIX



Connector red female / Złącze czerwone żeńskie: 6.4 mm (0.5-1.5 mm; 20 PCS), Connector red full female / Złącze czerwone pełne żeńskie: 4.8 mm (0.5-1.5 mm; 20 PCS), Connector red male / Złącze czerwone męskie: 4.8 mm (0.5-1.5 mm; 20 PCS), Connector red male male / Złącze czerwone męsko-męskie: 6.4 mm (0.5-1.5 mm; 40 PCS), Connector blue female / Złącze niebieskie żeńskie: 6.4 mm (1.5-2.5 mm; 20 PCS), Connector red full female / Złącze czerwone pełne żeńskie: 6.4 mm (0.5-1.5 mm; 20 PCS), Connector blue full female / Złącze niebieskie pełne żeńskie: 6.4 mm (1.5-2.5 mm; 20 PCS), Connector blue male male / Złącze niebieskie męsko-męskie: 6.4 mm (1.5-2.5 mm; 40 PCS), Connector blue male / Złącze niebieskie męskie: 4.8 mm (1.5-2.4 mm; 20 PCS), Connector blue female / Złącze niebieskie żeńskie: 4.8 mm (1.5-2.5 mm; 20 PCS)

YATO
YT-068912

60

EN Terminal assortment
 PL Zestaw złącz elektrycznych
 DE Kabelschuh-Set
 RU Набор электрических клемм
 CZ Sada elektrických konektorů
 HU Elektromos csatlakozókészlet

RO Set papuci auto
 FR Jeu de cosses de câbles
 IT Kit di connettori elettrici
 ES Juego de conectores eléctricos
 CN 接线端子

450
PCS

MIX



Connector female / Złącze żeńskie: 2.8 mm, 4.8 mm, 6.4 mm (x50 PCS); Connector male / Złącze męskie: 2.8 mm, 4.8 mm, 6.4 mm (x50 PCS); Connector with hole / Złącze z oczkiem: Ø3.2 mm, Ø5.2 mm, Ø8.2 mm (x50 PCS)

YATO
YT-068683

24

EN Terminal assortment
PL Zestaw złączy elektrycznych
DE Kabelschuh-Set
RU Набор электрических клемм
CZ Sada elektrických konektorů
HU Elektromos csatlakozókészlet

RO Set papuci auto
FR Jeu de cosses de câbles
IT Kit di connettori elettrici
ES Juego de conectores eléctricos
CN 接线端子

600
PCS

MIX

BRASS
MOSIADZ



EN Terminal assortment
PL Zestaw złączy elektrycznych
DE Kabelschuh-Set
RU Набор электрических клемм
CZ Sada elektrických konektorů
HU Elektromos csatlakozókészlet

RO Set papuci auto
FR Jeu de cosses de câbles
IT Kit di connettori elettrici
ES Juego de conectores eléctricos
CN 接线端子

600
PCS

MIX

BRASS
MOSIADZ



Connector female / Złącze żeńskie: 2.8 mm, 4.8 mm, 6.4 mm (x100 PCS); Connector male / Złącze męskie: 2.8 mm, 4.8 mm, 6.4 mm (x100 PCS)

YATO  **YT-068684**  24



PBDD 1-250, PBDD 2-250, PBDD 5-250, FDFD 5-250, RV 5.5-4, RV 5.5-5, RV 5.5-6 (x10 PCS); E1008 red / czerwone, E1508 red / czerwone, E2508 blue / niebieskie (x50 PCS); TE1008 red / czerwone, TE1508 red / czerwone, TE2510 red / czerwone, MDD 1-250, MDD 2-250 (x20 PCS); MDD 5-250, BV 5.5, FDD 5-250 (x10 PCS); FDFD 1-250, FDFD 2-250, RV 1.25-5, RV 2-5, BV 1.25, BV 2 (x15 PCS); RV 1.25-3, RV 1.25-4, RV 2-3, RV 2-4 (x30 PCS); FDD 1-250, FDD 2-250 (x20 PCS)

YATO  **YT-068913**  20

EN Insulated ferrules assortment
PL Zestaw końcówek i konektorów kablowych
DE Kabelschuh- und Verbinder-Set
RU Набор кабельных наконечников и коннекторов
CZ Sada kabelových koncovek a konektorů
HU Végződések és csatlakozókészlet

RO Set conectori
FR Jeu de cosses de câbles
IT Set di terminali e connettori per cavi
ES Set de puntas y conectores de cable
CN 欧式接线端子

685
PCS

MIX



EN Terminal assortment
PL Zestaw złączy elektrycznych
DE Kabelschuh-Set
RU Набор электрических клемм
CZ Sada elektrických konektorů
HU Elektromos csatlakozókészlet

RO Set papuci auto
FR Jeu de cosses de câbles
IT Kit di connettori elettrici
ES Juego de conectores eléctricos
CN 接线端子

750
PCS

MIX

BRASS
MOSIADZ



0.5 mm (50 PCS), 0.75 mm (50 PCS), 1 mm (100 PCS), 1.5 mm (250 PCS), 2.5 mm (150 PCS), 4 mm (50 PCS), 6 mm (25 PCS), 10 mm (10 PCS)

YATO  **YT-06895**  5/20



Connector female / Złącze żeńskie: 2.8 mm, 4.8 mm, 6.4 mm (x100 PCS); Connector male / Złącze męskie: 2.8 mm, 4.8 mm, 6.4 mm (x100 PCS); Connector with hole / Złącze z oczkiem: Ø3.2 mm, Ø5.2 mm, Ø6.2 mm, Ø8.2 mm, Ø10.5 mm (x30 PCS)

YATO  **YT-068685**  24

EN Crimp bootlace ferrules assortment
PL Zestaw końcówek kablowych
DE Aderendhülsen Set
RU Набор кабельных наконечников
CZ Sada kabelových koncovek
HU Kábelcsatlakozókészlet

RO Kit cepete sertizat cabluri fara izolare
FR Jeu de cosses de câbles
IT Set di terminali
ES Juego casquillos de cable
CN 接线端子

65
PCS

MIX

BRASS
MOSIADZ



EN Crimp bootlace ferrules assortment
PL Zestaw końcówek kablowych
DE Aderendhülsen Set
RU Набор кабельных наконечников
CZ Sada kabelových koncovek
HU Kábelcsatlakozókészlet

RO Kit cepete sertizat cabluri fara izolare
FR Jeu de cosses de câbles
IT Set di terminali
ES Juego casquillos de cable
CN 接线端子

1000
PCS

MIX

BRASS
MOSIADZ



SC6-6 (15 PCS), SC6-8 (10 PCS), SC10-6 (10 PCS), SC10-8 (10 PCS), SC16-6 (5 PCS), SC16-8 (5 PCS), SC25-6 (5 PCS), SC25-8 (5 PCS)

YATO  **YT-068915**  100



0.5 mm (ferrule length / długość okucia: 6 mm), 0.75 mm (ferrule length / długość okucia: 6 mm), 1 mm (ferrule length / długość okucia: 6 mm), 1.5 mm (ferrule length / długość okucia: 7 mm), 2.5 mm (ferrule length / długość okucia: 7 mm) (x200 PCS)

YATO  **YT-06896**  100

- EN Insulated ferrules assortment
 PL Zestaw końcówek i konektorów kablowych
 DE Kabelschuh- und Verbinder-Set
 RU Набор кабельных наконечников и коннекторов
 CZ Sada kabelových koncovek a konektorů
 HU Végződések és csatlakozókészlet
- RO Set conectori
 FR Jeu de coses de câbles
 IT Set di terminali e connettori per cavi
 ES Set de puntas y conectores de cable
 CN 欧式接线端子

1200
PCS

MIX



- EN Crimping tool and terminals set
 PL Zestaw złączy elektrycznych z zaciskarką
 DE Kabelschuh-Set mit Crimpzange
 RU Набор изолированных наконечников с пресс-клещами
 CZ Sada elektrických konektorů s kleštěmi
 HU Elektromos csatlakozókészlet krímelő fogóval
 RO Set sertizat conectori izoati
 FR Jeu de coses de câbles avec pince à sertir
 IT Kit di connettori elettrici con pinze
 ES Juego de conectores eléctricos con crimpadora
 CN 冷压工具组套

551
PCS

0.5-6.0
mm²



MIX



E1012 red / czerwone (25 PCS), E6012 green / zielone (25 PCS), E1008 red / czerwone (200 PCS), E2508 blue / niebieskie (250 PCS), E4010 grey / szare (50 PCS), E1508 black / czarne (250 PCS), E0508 white / białe (200 PCS), E7508 grey / szare (200 PCS)

YATO	
YT-068914	20



- 0.5-1.5 mm² (90 PCS), 1.5-2.5 mm² (90 PCS), 2.5-3.5 mm² (30 PCS);
 0.5-1.5 mm² (70 PCS), 1.5-2.5 mm² (70 PCS), 2.5-3.5 mm² (30 PCS);
 0.5-1.5 mm² (30 PCS), 1.5-2.5 mm² (30 PCS);
 0.5-1.5 mm² (30 PCS), 1.5-2.5 mm² (30 PCS)

YATO		mm ²		AWG	
YT-068920		0.5-6		22-10	10

- EN Terminal connectors
 PL Zestaw szybkozłączy elektrycznych
 DE Kabelschuhe schnellkupplung kabelklemme
 RU Набор экспресс-клемм
 CZ Rychlopojčky elektrických konektorů
 HU Gyors csatlakozó auto
- RO Conector rapid pt. auto
 FR Connecteur rapide
 IT Connettori terminali
 ES Conector rapido electrico
 CN 连接片组套

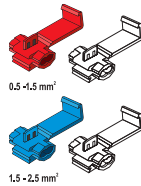

50
PCS

MIX



0.5-1.5 mm² (25 PCS), 1.5-2.5 mm² (25 PCS)

YATO	
YT-06868	5/20

- EN Heat-shrink tubing set
 PL Zestaw koszulek termokurczliwych
 DE Schrumpfschlauch-Set
 RU Набор термоусадочных трубок
 CZ Sada smršňovacích bužírek
 HU Zsugorcső készlet
- RO Set tuburi termocontractabile
 FR Jeu de gaines thermorétractables
 IT Kit guaine termorestringenti
 ES Kit de tubos termorretráctiles
 CN 热收缩管

100
PCS

max °C
125



Ø1.5x100 mm (30 PCS), Ø2.5x100 mm (30 PCS), Ø4x100 mm (20 PCS), Ø6x100 mm (10 PCS), Ø10x100 mm (6 PCS), Ø13x100 mm (4 PCS)

YATO	
YT-068661	24

- EN Heat-shrink tubing set
 PL Zestaw koszulek termokurczliwych
 DE Schrumpfschlauch-Set
 RU Набор термоусадочных трубок
 CZ Sada smršňovacích bužírek
 HU Zsugorcső készlet
- RO Set tuburi termocontractabile
 FR Jeu de gaines thermorétractables
 IT Kit guaine termorestringenti
 ES Kit de tubos termorretráctiles
 CN 热收缩管

100
PCS

MIX

max °C
125



Ø1.5x100 mm (30 PCS), Ø2.5x100 mm (30 PCS), Ø4x100 mm (20 PCS), Ø6x100 mm (10 PCS), Ø10x100 mm (6 PCS), Ø13x100 mm (4 PCS)

YATO	
YT-068667	24

- EN Heat-shrink tubing set
 PL Zestaw koszulek termokurczliwych
 DE Schrumpfschlauch-Set
 RU Набор термоусадочных трубок
 CZ Sada smršňovacích bužírek
 HU Zsugorcső készlet
- RO Set tuburi termocontractabile
 FR Jeu de gaines thermorétractables
 IT Kit guaine termorestringenti
 ES Kit de tubos termorretráctiles
 CN 热收缩管

127
PCS

MIX

max °C
125

max
600V



Ø2x40 mm, Ø2.5x40 mm, Ø3.5x40 mm, Ø5x40 mm, Ø7x80 mm, Ø10x80 mm, Ø13x85 mm

YATO	
YT-06866	5/20

EN Heat-shrink tubing set
PL Zestaw koszulek termokurczliwych
DE Schrumpfschlauch-Set
RU Набор термоусадочных трубок
CZ Sada smršťovacích bužírek
HU Zsugorcső készlet

RO Set tuburi termocontractabile
FR Jeu de gaines thermorétractables
IT Kit guaine termorestringenti
ES Kit de tubos termorretráctiles
CN 热收缩管

128
PCS

MIX

max°C
125



Ø2.5x8 mm (40 PCS), Ø3.5x80 mm (32 PCS), Ø5x80 mm (24 PCS), Ø7x80 mm (16 PCS), Ø10x80 mm (8 PCS), Ø13x80 mm (8 PCS)

YATO
YT-068668 24

EN Heat-shrink tubing with glue set
PL Zestaw koszulek termokurczliwych z klejem
DE Schrumpfschlauch-Set mit Kleber
RU Набор термоусадочных трубок с клеем
CZ Sada smršťovacích bužírek s lepidlem
HU Ragasztós zsugorcső készlet

RO Set tub termocontractabil cu lipici
FR Jeu de gaines thermorétractables avec adhésif
IT Kit guaine termorestringenti con adesivo
ES Kit de tubos termorretráctiles adhesivos
CN 带胶热缩套管

270
PCS

MIX

max°C
125



Ø1.6x45 mm (70 PCS), Ø2.4x45 mm (80 PCS), Ø3.2x45 mm (80 PCS), Ø4.8x90 mm (20 PCS), Ø6.3x90 mm (12 PCS), Ø9.5x90 mm (8 PCS)

YATO
YT-068671 60

EN Heat shrink solder sleeve
PL Koszulka termokurczliwa z cyną
DE Wärmeschumpfende Verbinder mit Zinn
RU Термоусадочная гильза с оловом
CZ Smršťovací trubička s cínem
HU Hőre zsugorodó hüvely ónnal
RO Manson pt. lipit cu aer cald
FR Gaine thermorétractable avec étain
IT Guaine termorestringenti con stagno
ES Tubo termorretráctil con estaño
CN 免压热缩中接焊锡端子

30
PCS

0.25
x0.34
mm²

105
°C



YATO
YT-81440 Cross-sectional area / Przekrój przewodu 0.25-0.34 mm² / 24~22 AWG 25/1500

EN Heat-shrink tubing set
PL Zestaw koszulek termokurczliwych
DE Schrumpfschlauch-Set
RU Набор термоусадочных трубок
CZ Sada smršťovacích bužírek
HU Zsugorcső készlet

RO Set tuburi termocontractabile
FR Jeu de gaines thermorétractables
IT Kit guaine termorestringenti
ES Kit de tubos termorretráctiles
CN 热收缩管

171
PCS

MIX

max°C
125



Ø2x30 mm (100 PCS), Ø4x60 mm (10 PCS), Ø4.5x60 mm (10 PCS), Ø5x60 mm (8 PCS), Ø6x60 mm (6 PCS), Ø8x90 mm (11 PCS), Ø9x90 mm (11 PCS), Ø12x90 mm (7 PCS), Ø18x90 mm (7 PCS), Ø10x100 mm (1 PCS)

YATO
YT-06867 24

EN Heat-shrink tubing with glue set
PL Zestaw koszulek termokurczliwych z klejem
DE Schrumpfschlauch-Set mit Kleber
RU Набор термоусадочных трубок с клеем
CZ Sada smršťovacích bužírek s lepidlem
HU Ragasztós zsugorcső készlet

RO Set tub termocontractabil cu lipici
FR Jeu de gaines thermorétractables avec adhésif
IT Kit guaine termorestringenti con adesivo
ES Kit de tubos termorretráctiles adhesivos
CN 带胶热缩套管

530
PCS

MIX

max°C
125



Ø1.5x45 mm (80 PCS), Ø2x45 mm (160 PCS), Ø3x45 mm (60 PCS), Ø4x45 mm (100 PCS), Ø5x45 mm (30 PCS), 6x45 mm (20 PCS), Ø6x45 mm (20 PCS), Ø10x45 mm (60 PCS)

YATO
YT-068672 60

EN Heat shrink solder sleeve
PL Koszulka termokurczliwa z cyną
DE Wärmeschumpfende Verbinder mit Zinn
RU Термоусадочная гильза с оловом
CZ Smršťovací trubička s cínem
HU Hőre zsugorodó hüvely ónnal
RO Manson pt. lipit cu aer cald
FR Gaine thermorétractable avec étain
IT Guaine termorestringenti con stagno
ES Tubo termorretráctil con estaño
CN 免压热缩中接焊锡端子

100
PCS

0.25
x0.34
mm²

105
°C



YATO
YT-81451 Cross-sectional area / Przekrój przewodu 0.25-0.34 mm² / 24~22 AWG 558

EN Heat shrink solder sleeve
 PL Koszulka termokurczliwa z cyną
 DE Wärmeschrumpfende Verbinder mit Zinn
 RU Термоусадочная гильза с оловом
 CZ Smršťovací trubička s cínem
 HU Hőre zsugorodó hüvely ónnal
 RO Manson pt. lipit cu aer cald
 FR Gaine thermorétractable avec étain
 IT Guaine termorestringenti con stagno
 ES Tubo termorretráctil con estaño
 CN 免压热缩中接焊锡端子

30 PCS 0.5 x1.5 mm² 105 °C

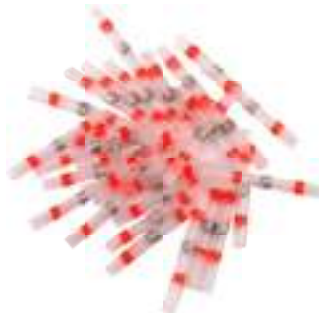

EN Heat shrink solder sleeve
 PL Koszulka termokurczliwa z cyną
 DE Wärmeschrumpfende Verbinder mit Zinn
 RU Термоусадочная гильза с оловом
 CZ Smršťovací trubička s cínem
 HU Hőre zsugorodó hüvely ónnal
 RO Manson pt. lipit cu aer cald
 FR Gaine thermorétractable avec étain
 IT Guaine termorestringenti con stagno
 ES Tubo termorretráctil con estaño
 CN 免压热缩中接焊锡端子

100 PCS 0.5 x1.5 mm² 105 °C

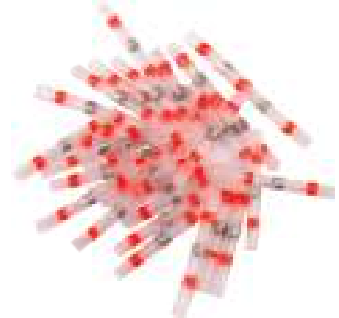

YATO	Cross-sectional area / Przekrój przewodu	
YT-81441	0.5-1.5 mm ² / 18~16 AWG	15/900

YATO	Cross-sectional area / Przekrój przewodu	
YT-81452	0.5-1.5 mm ² / 20~16 AWG	378

EN Heat shrink solder sleeve
 PL Koszulka termokurczliwa z cyną
 DE Wärmeschrumpfende Verbinder mit Zinn
 RU Термоусадочная гильза с оловом
 CZ Smršťovací trubička s cínem
 HU Hőre zsugorodó hüvely ónnal
 RO Manson pt. lipit cu aer cald
 FR Gaine thermorétractable avec étain
 IT Guaine termorestringenti con stagno
 ES Tubo termorretráctil con estaño
 CN 免压热缩中接焊锡端子

30 PCS 1.5 x2.5 mm² 105 °C



EN Heat shrink solder sleeve
 PL Koszulka termokurczliwa z cyną
 DE Wärmeschrumpfende Verbinder mit Zinn
 RU Термоусадочная гильза с оловом
 CZ Smršťovací trubička s cínem
 HU Hőre zsugorodó hüvely ónnal
 RO Manson pt. lipit cu aer cald
 FR Gaine thermorétractable avec étain
 IT Guaine termorestringenti con stagno
 ES Tubo termorretráctil con estaño
 CN 免压热缩中接焊锡端子

100 PCS 1.5 x2.5 mm² 105 °C



YATO	Cross-sectional area / Przekrój przewodu	
YT-81442	1.5-2.5 mm ² / 16~14 AWG	5/300

YATO	Cross-sectional area / Przekrój przewodu	
YT-81453	1.5-2.5 mm ² / 16~14 AWG	130

EN Heat shrink solder sleeve
 PL Koszulka termokurczliwa z cyną
 DE Wärmeschrumpfende Verbinder mit Zinn
 RU Термоусадочная гильза с оловом
 CZ Smršťovací trubička s cínem
 HU Hőre zsugorodó hüvely ónnal
 RO Manson pt. lipit cu aer cald
 FR Gaine thermorétractable avec étain
 IT Guaine termorestringenti con stagno
 ES Tubo termorretráctil con estaño
 CN 免压热缩中接焊锡端子

20 PCS 4.0 x6.0 mm² 105 °C



EN Heat shrink solder sleeve
 PL Koszulka termokurczliwa z cyną
 DE Wärmeschrumpfende Verbinder mit Zinn
 RU Термоусадочная гильза с оловом
 CZ Smršťovací trubička s cínem
 HU Hőre zsugorodó hüvely ónnal
 RO Manson pt. lipit cu aer cald
 FR Gaine thermorétractable avec étain
 IT Guaine termorestringenti con stagno
 ES Tubo termorretráctil con estaño
 CN 免压热缩中接焊锡端子

100 PCS 4.0 x6.0 mm² 105 °C



YATO	Cross-sectional area / Przekrój przewodu	
YT-81443	4-6 mm ² / 12~10 AWG	5/300

YATO	Cross-sectional area / Przekrój przewodu	
YT-81454	4-6 mm ² / 12~10 AWG	100

EN Heat shrink solder sleeve set
 PL Zestaw koszulek termokurczliwych z cyną
 DE Satz wärmeschrumpfender Verbinder mit Zinn
 RU Комплект термоусадочных гильз с оловом
 CZ Sada smršťovacích trubiček s cínem
 HU Hőre zsugorodó hüvelykészlet ónnal

RO Set mansoane lipit cu aer cald
 FR Jeu de gaines thermorétractables avec étain
 IT Set di guaine termorestringenti con stagno
 ES Conjunto de tubos termorretráctiles con estaño
 CN 免压热缩中接焊锡端子

100 PCS

0.25 x6.0 mm²

105 °C



YATO	Cross-sectional area / Przekrój przewodu	
YT-81450	0.25-6 mm ² / 26~10 AWG	150

EN Heat shrink solder sleeve set
 PL Zestaw koszulek termokurczliwych z cyną
 DE Satz wärmeschrumpfender Verbinder mit Zinn
 RU Комплект термоусадочных гильз с оловом
 CZ Sada smršťovacích trubiček s cínem
 HU Hőre zsugorodó hüvelykészlet ónnal
 RO Set mansoane lipit cu aer cald
 FR Jeu de gaines thermorétractables avec étain
 IT Set di guaine termorestringenti con stagno
 ES Kit de capas termorretrácteis com estanho
 CN 免压热缩中接焊锡管

220 PCS 0.25 x6.0 mm² 105 °C



YATO	Cross-sectional area / Przekrój przewodu	
YT-81460	0.25-6 mm ² / 24~10 AWG	60

- EN Heat shrink butt connectors set
PL Zestaw zaciskanych koszulek termokurczliwych
DE Satz gewellte Schrumpfhüllen
RU Набор обжимных термоусадочных трубок
CZ Sada upínacích teplém smrštitelných bužirek
HU Szigetelt toldóhüvely készlet
RO Set de conectori termocontractabili
FR Jeu de manchons thermorétractables sertis
IT Set di giunti termorestringenti con stagno
ES Juego de tubos termorretráctiles
CN 防水热缩端子

200
PCS

0.5
x6.0
mm²



0.5-1.5 mm² (90 PCS), 1.5-2.5 mm² (90 PCS), 4.0-6.0 mm² (20 PCS)

YATO	Cross-sectional area / Przekrój przewodu	
YT-81461	0.5-6 mm ² / 20~10 AWG	60

- EN Back probe kit
PL Zestaw przewodów i końcówek pomiarowych
DE Messleitungen und -endstücke
RU Набор кабелей и измерительных наконечников
CZ Sada měřících vodičů a koncovek
HU Vezeték és mérőfej készlet
- RO Trusa de sondă spată
FR Kit de cordons et de fiches de test
IT Set di cavi e terminali di misura
ES Juego de cables y puntas de medición
CN 万用表

20
PCS

0-30V
A.C.

0-30V
D.C.



YATO	
YT-73079	24

- EN Car fuse assortment
PL Zestaw bezpieczników
DE KFZ-Sicherungs-Set
RU Набор предохранителей
CZ Sada pojistek
HU Biztosítékkészlet
- RO Set sigurante
FR Ensemble de fusible
IT Kit di fusibili lamellari
ES Conjunto de fusibles
CN 保险插片

92
PCS

STANDARD

FUSE
PULLER
ŚCIĄGACZ
BEZPIECZNIKÓW



5 A, 10 A, 15 A, 20 A, 25 A, 30 A (x15 PCS); tester 6-24 V

YATO	
YT-83142	24

- EN Car fuse assortment
PL Zestaw bezpieczników
DE KFZ-Sicherungs-Set
RU Набор предохранителей
CZ Sada pojistek
HU Biztosítékkészlet
- RO Set sigurante
FR Ensemble de fusible
IT Kit di fusibili lamellari
ES Conjunto de fusibles
CN 保险插片

100
PCS

MINI



7.5 A (10 PCS), 10 A (20 PCS), 15 A (20 PCS), 20 A (20 PCS), 25 A (20 PCS), 30 A (10 PCS)

YATO	
YT-83145	12/60

- EN Supersal connectors wiring assortment
PL Zestaw złączy elektrycznych hermetycznych
DE Hermetischer Elektrostecker Satz
RU Набор герметичных электрических разъемов
CZ Sada hermetických elektrických svorek
HU Hermetikus elektromos csatlakozókészlet
- RO Mufe auto
FR Jeu de connecteurs électriques hermétiques
IT Kit di connettori elettrici a tenuta stagna
ES Set de herméticos conectores eléctricos
CN 低压电源线束快速接头

424
PCS

HERMETIC
HERMETYCZNE

1-6
PIN

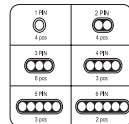

YATO	
YT-06869	6/12

- EN Car fuse assortment
PL Zestaw bezpieczników
DE KFZ-Sicherungs-Set
RU Набор предохранителей
CZ Sada pojistek
HU Biztosítékkészlet
- RO Set sigurante
FR Ensemble de fusible
IT Kit di fusibili lamellari
ES Conjunto de fusibles
CN 保险插片

24
PCS

MAXI



20 A, 30 A, 40 A, 50 A, 60 A, 70 A, 80 A, 100 A (x3 PCS)

YATO	
YT-83140	24

- EN Car fuse assortment
PL Zestaw bezpieczników
DE KFZ-Sicherungs-Set
RU Набор предохранителей
CZ Sada pojistek
HU Biztosítékkészlet
- RO Set sigurante
FR Ensemble de fusible
IT Kit di fusibili lamellari
ES Conjunto de fusibles
CN 保险插片

97
PCS

STANDARD

FUSE
PULLER
ŚCIĄGACZ
BEZPIECZNIKÓW



3 A, 5 A, 7.5 A, 10 A, 15 A, 20 A, 25 A, 30 A (x12 PCS)

YATO	
YT-83141	24

- EN Car fuse assortment
PL Zestaw bezpieczników
DE KFZ-Sicherungs-Set
RU Набор предохранителей
CZ Sada pojistek
HU Biztosítékkészlet
- RO Set sigurante
FR Ensemble de fusible
IT Kit di fusibili lamellari
ES Conjunto de fusibles
CN 120汽车保险片

120
PCS

MINI



5 A, 10 A, 15 A, 20 A, 25 A, 30 A (x20 PCS)

YATO	
YT-83146	12

EN Car fuse assortment
 PL Zestaw bezpieczników
 DE KFZ-Sicherungs-Set
 RU Набор предохранителей
 CZ Sada pojistek
 HU Biztosítékkészlet

RO Set sigurante
 FR Ensemble de fusible
 IT Kit di fusibili lamellari
 ES Conjunto de fusibles
 CN 保险插片



88
PCS

STANDARD

MAXI

MINI

Mini: 3 A, 5 A, 7.5 A, 10 A, 15 A, 20 A, 25 A, 30 A (x5 PCS); standard: 3 A, 5 A, 7.5 A, 10 A, 15 A, 20 A, 25 A, 30 A (x5 PCS); max: 20 A, 30 A, 40 A, 50 A, 60 A, 70 A, 80 A, 100 A

YATO

YT-83147 24

EN Car fuse assortment
 PL Zestaw bezpieczników
 DE KFZ-Sicherungs-Set
 RU Набор предохранителей
 CZ Sada pojistek
 HU Biztosítékkészlet

RO Set sigurante
 FR Ensemble de fusible
 IT Kit di fusibili lamellari
 ES Conjunto de fusibles
 CN 保险插片



301
PCS

STANDARD

MINI

FUSE PULLER
SCHNAPPCZ
BEZPECZNIKOW

Mini: 2 A (6 PCS), 3 A (6 PCS), 5 A (12 PCS), 7.5 A (10 PCS), 10 A (28 PCS), 15 A (24 PCS), 20 A (22 PCS), 25 A (10 PCS), 30 A (14 PCS), 35 A (6 PCS), 40 A (12 PCS); standard: 2 A (6 PCS), 3 A (6 PCS), 5 A (12 PCS), 7.5 A (10 PCS), 10 A (28 PCS), 15 A (24 PCS), 20 A (22 PCS), 25 A (10 PCS), 30 A (14 PCS), 35 A (6 PCS), 40 A (12 PCS); clip

YATO

YT-83148 20

EN Car fuse assortment
 PL Zestaw bezpieczników
 DE KFZ-Sicherungs-Set
 RU Набор предохранителей
 CZ Sada pojistek
 HU Biztosítékkészlet

RO Set sigurante
 FR Ensemble de fusible
 IT Kit di fusibili lamellari
 ES Conjunto de fusibles
 CN 120汽车保险片



120
PCS

STANDARD

5 A, 10 A, 15 A, 20 A, 25 A, 30 A (x20 PCS)

YATO

YT-83144 12

EN Car fuse assortment
 PL Zestaw bezpieczników
 DE KFZ-Sicherungs-Set
 RU Набор предохранителей
 CZ Sada pojistek
 HU Biztosítékkészlet

RO Set sigurante
 FR Ensemble de fusible
 IT Kit di fusibili lamellari
 ES Conjunto de fusibles
 CN 保险插片



121
PCS

MINI

FUSE PULLER
SCHNAPPCZ
BEZPECZNIKOW

5 A, 10 A, 15 A, 20 A, 25 A, 30 A (x20 PCS)

YATO

YT-83143 24

EN Glass fuse assortment
 PL Zestaw bezpieczników szklanych
 DE Glas-Sicherungssatz
 RU Набор стеклянных предохранителей
 CZ Sada sklených pojistek
 HU Üvegbiztosíték készlet

RO Set sigurante sticla
 FR Ensemble de fusibles en verre
 IT Set di fusibili in vetro
 ES Set de fusibles de vidrio
 CN 玻璃管保险丝



120
PCS

6x30
mm

GLASS
SZKLO

5 A, 10 A, 15 A, 20 A, 25 A, 30 A (x20 PCS)

YATO

YT-83130 5/20

EN Trim clips assortment
 PL Komplet spinek samochodowych
 DE Befestigungs-Clip-Satz
 RU Набор автомобильного крепежа
 CZ Sada příchytek čalounění
 HU Kötőelemek szegecsek
 RO Clip de plastic asortat
 FR Ensembles de clips en plastique auto
 IT Set di clip per auto
 ES Clip de plástico surtido
 CN 塑料卡扣



360
PCS

18
TYPES
TYPY

Toyota, Lexus

YATO

YT-06650 20

EN Trim clips assortment
 PL Komplet spinek samochodowych
 DE Befestigungs-Clip-Satz
 RU Набор автомобильного крепежа
 CZ Sada příchytek čalounění
 HU Kötőelemek szegecsek
 RO Clip de plastic asortat
 FR Ensembles de clips en plastique auto
 IT Set di clip per auto
 ES Clip de plástico surtido
 CN 塑料卡扣



300
PCS

6
TYPES
TYPY

Renault

YATO

YT-06651 20

EN Trim clips assortment
 PL Komplet spinek samochodowych
 DE Befestigungs-Clip-Satz
 RU Набор автомобильного крепежа
 CZ Sada příchytek čalounění
 HU Kötőelemek szegecsek
 RO Clip de plastic asortat
 FR Ensembles de clips en plastique auto
 IT Set di clip per auto
 ES Clip de plástico surtido
 CN 塑料卡扣



300
PCS

6
TYPES
TYPY

Opel

YATO

YT-06652 20

EN Trim clips assortment
PL Komplet spinek samochodowych
DE Befestigungs-Clip-Satz
RU Набор автомобильного крепежа
CZ Sada přichytek čalounění
HU Kötőelemek szegecsek
RO Clip de plastic asortat
FR Ensembles de clips en plastique auto
IT Set di clip per auto
ES Clip de plástico surtido
CN 塑料卡扣

345
PCS

12
TYPES
TYPY

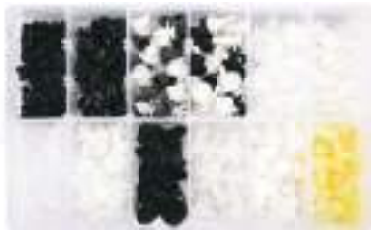

Peugeot

YATO

YT-06653

20

EN Trim clips assortment
PL Komplet spinek samochodowych
DE Befestigungs-Clip-Satz
RU Набор автомобильного крепежа
CZ Sada přichytek čalounění
HU Kötőelemek szegecsek
RO Clip de plastic asortat
FR Ensembles de clips en plastique auto
IT Set di clip per auto
ES Clip de plástico surtido
CN 塑料卡扣

350
PCS

12
TYPES
TYPY



Volvo

YATO

YT-06655

20

EN Trim clips assortment
PL Komplet spinek samochodowych
DE Befestigungs-Clip-Satz
RU Набор автомобильного крепежа
CZ Sada přichytek čalounění
HU Kötőelemek szegecsek
RO Clip de plastic asortat
FR Ensembles de clips en plastique auto
IT Set di clip per auto
ES Clip de plástico surtido
CN 塑料卡扣

408
PCS

18
TYPES
TYPY

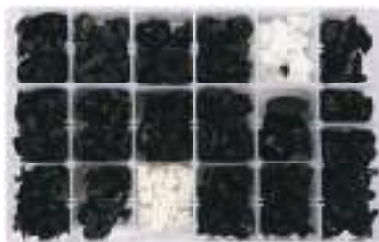

Nissan

YATO

YT-06657

20

EN Trim clips assortment
PL Komplet spinek samochodowych
DE Befestigungs-Clip-Satz
RU Набор автомобильного крепежа
CZ Sada přichytek čalounění
HU Kötőelemek szegecsek
RO Clip de plastic asortat
FR Ensembles de clips en plastique auto
IT Set di clip per auto
ES Clip de plástico surtido
CN 塑料卡扣

370
PCS

12
TYPES
TYPY



Mitsubishi

YATO

YT-06659

20

EN Trim clips assortment
PL Komplet spinek samochodowych
DE Befestigungs-Clip-Satz
RU Набор автомобильного крепежа
CZ Sada přichytek čalounění
HU Kötőelemek szegecsek
RO Clip de plastic asortat
FR Ensembles de clips en plastique auto
IT Set di clip per auto
ES Clip de plástico surtido
CN 塑料卡扣

308
PCS

12
TYPES
TYPY



Fiat

YATO

YT-06654

20

EN Trim clips assortment
PL Komplet spinek samochodowych
DE Befestigungs-Clip-Satz
RU Набор автомобильного крепежа
CZ Sada přichytek čalounění
HU Kötőelemek szegecsek
RO Clip de plastic asortat
FR Ensembles de clips en plastique auto
IT Set di clip per auto
ES Clip de plástico surtido
CN 塑料卡扣

418
PCS

18
TYPES
TYPY



Honda

YATO

YT-06656

20

EN Trim clips assortment
PL Komplet spinek samochodowych
DE Befestigungs-Clip-Satz
RU Набор автомобильного крепежа
CZ Sada přichytek čalounění
HU Kötőelemek szegecsek
RO Clip de plastic asortat
FR Ensembles de clips en plastique auto
IT Set di clip per auto
ES Clip de plástico surtido
CN 塑料卡扣

475
PCS

18
TYPES
TYPY



Mazda

YATO

YT-06658

20

EN Trim clips assortment
PL Komplet spinek samochodowych
DE Befestigungs-Clip-Satz
RU Набор автомобильного крепежа
CZ Sada přichytek čalounění
HU Kötőelemek szegecsek
RO Clip de plastic asortat
FR Ensembles de clips en plastique auto
IT Set di clip per auto
ES Clip de plástico surtido
CN 塑料卡扣

415
PCS

18
TYPES
TYPY



Ford

YATO

YT-06660

20

Memo

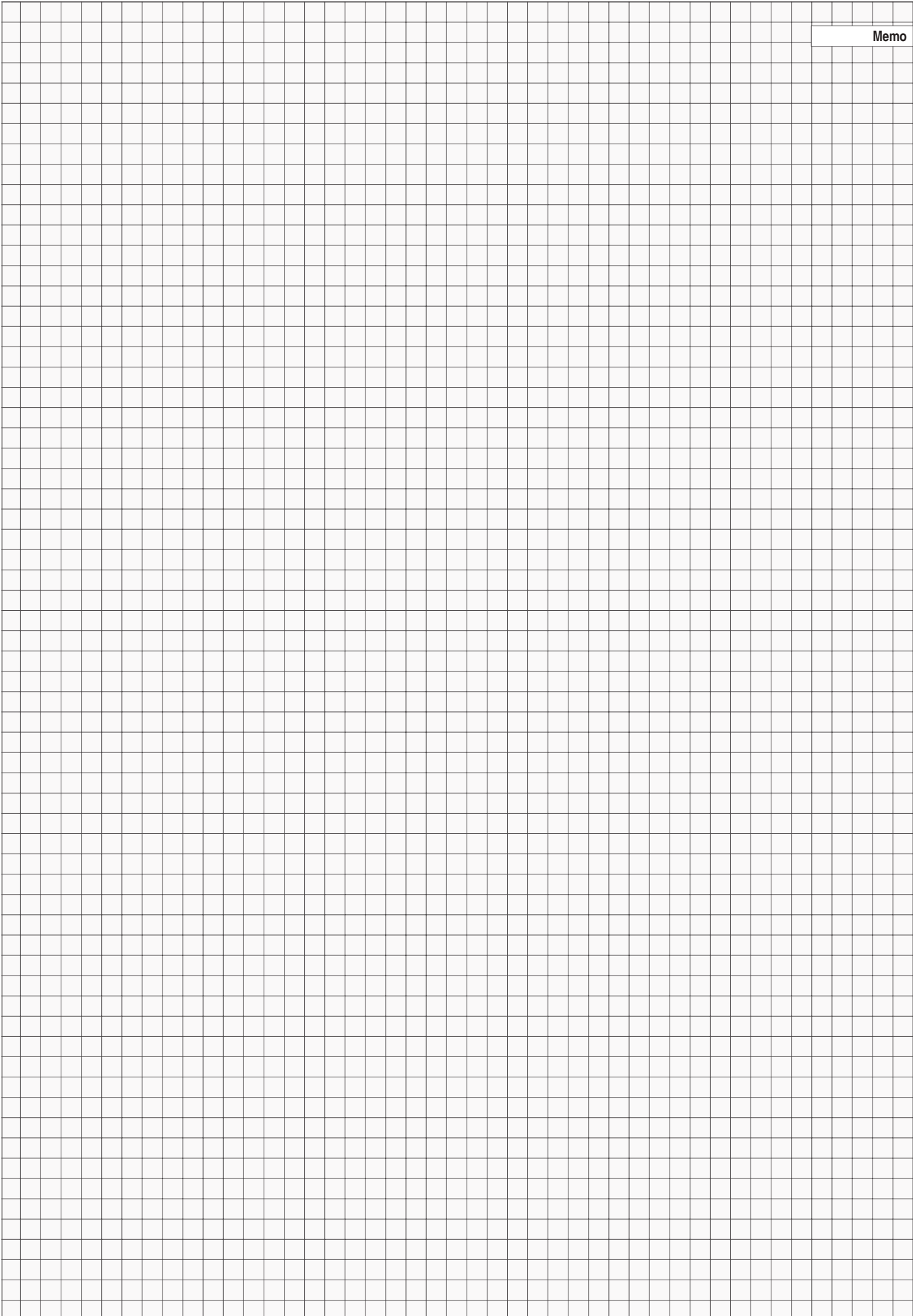

17

Welding equipment & accessories
Narzędzia spawalnicze i akcesoria



Welding helmets & accessories
Przyłbice spawalnicze i akcesoria

490-491



Combination edge setters & hole punch pliers
Dziurkarko-felcarki

492



Welding workbenches
Stoliki spawalnicze

492



Magnetic holders
Wsporniki magnetyczne

492-495



Spot weld cutter sets
Zestawy rozwiertaków do zgrzewów

492



- EN Auto-darkening welding helmet
- PL Przyłbica spawalnicza samościemniająca
- DE Schweissmaske, selbstverdunkelnd
- RU Маска сварщика с автозатемнением
- CZ Svářečská kukla samostmívací
- HU Őnmagától sötétedő hegesztőpajzs
- RO Mască de sudură auto-intunecare
- FR Masque de soudage
- IT Oscuramento casco di saldatura
- ES Casco auto-oscurecedor para soldadura
- CN 焊帽



DIN 9-13	SHADE SCIEŃNIANIE	DIN 4	OPTICAL CLASS KLASA OPTYCZNA	98x43 mm	4 ARC SENSOR CZUJNIKI ŁUKU	1/25000s REACTION TIME CZAS REAKCJI	SENSITIVITY CZUŁOŚĆ	0.1-1.0s	DELAY OPÓZNIENIE
FILTER TEST TEST FILTRA	DIN 16 UV/IR	SOLAR CELL OGNiWO SŁONECZNE	2x CR2450	LOW BATTERY ALARM WSKAZNIK POZIOMU BATERII	4-POINT HEADGEAR WIEŻBA 4-PUNKTOWA	AUTO ON / OFF AUTO WŁ. WYŁ.	°C +5	MIG/MAG MMA/TIG	GRINDING SZLIFOWANIE
									CUTTING CIĘCIE

4 POINT HEADGEAR WIEŻBA 4 PUNKTOWA
Lock into a detent when lifted
Blokada w pozycji podniesionej

2-point crown strap adjustment to rise or lower the helmet
2 punktowa regulacja wysokości

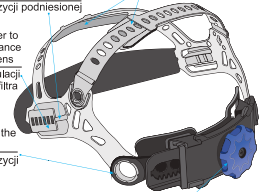

3 position slider to adjust the distance from eyes to lens
3 pozycje regulacji odległości od filtra

Regulation at the occipital area
Regulacja pozycji potylicznej

Ratchet with soft rubber grip to adjust size without removing the helmet
Regulacji obwodu za pomocą systemu grzechotkowego

- In accordance with standard EN 379
- Optical class: 1/1/1/1
- Cover lens YT-73924 included
- Zgodność z normą EN 379
- Klasa optyczna: 1/1/1/1
- W zestawie szybki ochronne YT-73924

Grinding Function: YES Funkcja szlifowania: TAK	Solar cell filter power supply during welding Ogniwio słoneczne zasila filtry podczas spawania	Arc Sensor: 4 Liczba czujników łuku: 4	Sensitivity Control Regulacja czułości
Shade Control: external, variable Regulacja przyciemnienia: zewnętrzna, płynna regulacja	Viewing Area: 98x43 mm Obszar pola widzenia: 98x43 mm	UV/IR Protection Ochrona przed promieniowaniem UV/IR	The rate of dimming Szybkość ściemniania 0.3 - 1.0 ms

YATO
YT-73921 6

- EN Auto-darkening welding helmet
- PL Przyłbica spawalnicza samościemniająca
- DE Schweissmaske, selbstverdunkelnd
- RU Маска сварщика с автозатемнением
- CZ Svářečská kukla samostmívací
- HU Őnmagától sötétedő hegesztőpajzs
- RO Mască de sudură auto-intunecare
- FR Masque de soudage
- IT Oscuramento casco di saldatura
- ES Casco auto-oscurecedor para soldadura
- CN 焊帽

TRUE COLOR	DIN 5-8/9-13	SHADE SCIEŃNIANIE	DIN 4	OPTICAL CLASS KLASA OPTYCZNA	100x68 mm
4 ARC SENSOR CZUJNIKI ŁUKU	1/25000s REACTION TIME CZAS REAKCJI	SENSITIVITY CZUŁOŚĆ	0.2-1.0s	DELAY OPÓZNIENIE	FILTER TEST TEST FILTRA
DIN 16 UV/IR	SOLAR CELL OGNiWO SŁONECZNE	1x CR2450	USB CHARGING ŁADOWANIE	LOW BATTERY ALARM WSKAZNIK POZIOMU BATERII	4-POINT HEADGEAR WIEŻBA 4-PUNKTOWA
					MIG/MAG MMA/TIG
					GRINDING AND WELDING SZLIFOWANIE I SPAWANIE
					CUTTING CIĘCIE

- In accordance with standard EN 379
- Optical class: 1/1/1/1
- Zgodność z normą EN 379
- Klasa optyczna: 1/1/1/1

- EN Auto-darkening welding helmet
- PL Przyłbica spawalnicza samościemniająca
- DE Schweissmaske, selbstverdunkelnd
- RU Маска сварщика с автозатемнением
- CZ Svářečská kukla samostmívací
- HU Őnmagától sötétedő hegesztőpajzs
- RO Mască de sudură auto-intunecare
- FR Masque de soudage
- IT Oscuramento casco di saldatura
- ES Casco auto-oscurecedor para soldadura
- CN 焊帽

TRUE COLOR	DIN 5-9/9-13	SHADE SCIEŃNIANIE	DIN 4	OPTICAL CLASS KLASA OPTYCZNA	100x97 mm
4 ARC SENSOR CZUJNIKI ŁUKU	1/25000s REACTION TIME CZAS REAKCJI	SENSITIVITY CZUŁOŚĆ	0.2-1.0s	DELAY OPÓZNIENIE	FILTER TEST TEST FILTRA
DIN 16 UV/IR	SOLAR CELL OGNiWO SŁONECZNE	1x CR2450	LOW BATTERY ALARM WSKAZNIK POZIOMU BATERII	4-POINT HEADGEAR WIEŻBA 4-PUNKTOWA	MIG/MAG MMA/TIG
					GRINDING AND WELDING SZLIFOWANIE I SPAWANIE
					CUTTING CIĘCIE

- In accordance with standard EN 379
- Optical class: 1/1/1/1
- Zgodność z normą EN 379
- Klasa optyczna: 1/1/1/1



YATO
YT-73930 6

YATO
YT-73932 6

EN Auto-darkening welding helmet
PL Przyłbica spawalnicza samościemniająca
DE Schweissmaske, selbstverdunkelnd
RU Маска сварщика с автозатемнением
CZ Svářečská kukla samostmívací
HU Őnmgától sötétedő hegesztőpajzs
RO Mască de sudură auto-intunecare
FR Masque de soudage
IT Oscuramento casco di saldatura
ES Casco auto-obscurecedor para soldadura
CN 焊帽

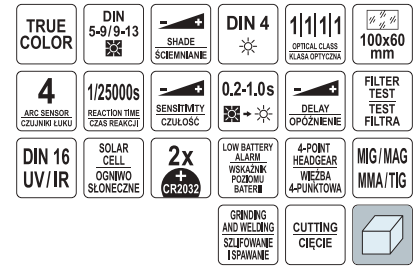

• In accordance with standard EN 379
• Optical class: 1/1/1/1
• Zgodność z normą EN 379
• Klasa optyczna: 1/1/1/1



EN Front cover lens
PL Szybka ochronna do przyłbicy samościemniającej
DE Außerschutzglas
RU Стекло защитное наружное
CZ Přední krycí sklíčko
HU Külső védőlemez
RO Protecția exterioră de plastic
FR Verres de protection
IT Lente per casco da saldatura
ES Cubierta de la lente de soldadura
CN 焊帽镜片



For YT-73930
Dla YT-73930
TYPE EN 166:2001 F



EN Front cover lens
PL Szybka ochronna do przyłbicy samościemniającej
DE Außerschutzglas
RU Стекло защитное наружное
CZ Přední krycí sklíčko
HU Külső védőlemez
RO Protecția exterioră de plastic
FR Verres de protection
IT Lente per casco da saldatura
ES Cubierta de la lente de soldadura
CN 焊帽镜片

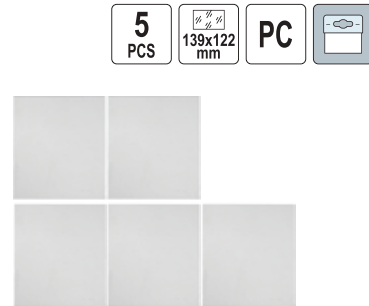

For YT-73932
Dla YT-73932
TYPE EN 166:2001 F



EN Front cover lens
PL Szybka ochronna do przyłbicy samościemniającej
DE Außerschutzglas
RU Стекло защитное наружное
CZ Přední krycí sklíčko
HU Külső védőlemez
RO Protecția exterioră de plastic
FR Verres de protection
IT Lente per casco da saldatura
ES Cubierta de la lente de soldadura
CN 焊帽镜片

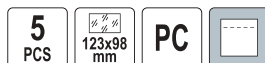

For YT-73921
Dla YT-73921
TYPE FC-11 EN 166:2001 B



EN Front cover lens
PL Szybka ochronna do przyłbicy samościemniającej
DE Außerschutzglas
RU Стекло защитное наружное
CZ Přední krycí sklíčko
HU Külső védőlemez
RO Protecția exterioră de plastic
FR Verres de protection
IT Lente per casco da saldatura
ES Cubierta de la lente de soldadura
CN 焊帽镜片

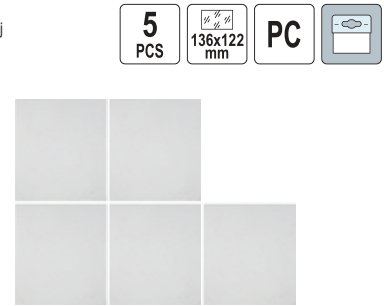

For YT-73934
Dla YT-73934
TYPE EN 166:2001 F



EN Front cover lens
PL Szybka ochronna do przyłbicy samościemniającej
DE Außerschutzglas
RU Стекло защитное наружное
CZ Přední krycí sklíčko
HU Külső védőlemez
RO Protecția exterioră de plastic
FR Verres de protection
IT Lente per casco da saldatura
ES Cubierta de la lente de soldadura
CN 焊帽镜片



For YT-73925, YT-73926, 74484
Dla YT-73925, YT-73926, 74484
TYPE EN 166:2001 F

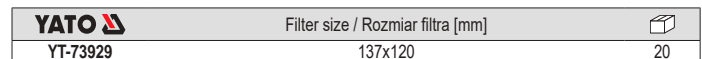

EN Welding workbench
 PL Stolik spawalniczy składany
 DE Schweißstisch zusammenklappbar
 RU Складной сварочный стол
 CZ Svářečský stůlk skládaný
 HU Összecsukható hegesztőasztal
 RO Banc de lucru pt. sudura
 FR Table de soudage pliante
 IT Banco per saldatura pieghevole
 ES Mesa de soldadura plegable
 CN 焊接工作台





660x590
x830 mm
max 150 kg



YATO Dimensions / Wymiary [mm] 
 YT-08950 660x590x830 1

EN Spot weld cutter & drill bit set
 PL Zestaw rozwiertaków do zgrzewów punktowych
 DE Schweisspunktbohrer Set Schweißpunktfäser
 RU Набор для высверливания точечной сварки
 CZ Sada na odvrtání bodových svárů
 HU Hegesztőpont maró készlet
 RO Set de freze pt. suduri în puncte
 FR Jeu de fraises pour points de soudage
 IT Set di alesatori per punti di saldatura
 ES Juego de puntos de soldadura de la fresa
 CN 电焊钻



9 PCS

 10 mm

 8 mm

HSS

YATO 
 YT-28920 10/60

EN Spot weld cutter & drill bit set
 PL Zestaw rozwiertaków do zgrzewów punktowych
 DE Schweisspunktbohrer Set Schweißpunktfäser
 RU Набор для высверливания точечной сварки
 CZ Sada na odvrtání bodových svárů
 HU Hegesztőpont maró készlet
 RO Set de freze pt. suduri în puncte
 FR Jeu de fraises pour points de soudage
 IT Set di alesatori per punti di saldatura
 ES Juego de puntos de soldadura de la fresa
 CN 电焊钻



9 PCS

 8 mm

 10 mm



YATO 
 YT-28919 10/60

EN Spot weld drill bits set
 PL Zestaw wiertel do zgrzewów punktowych
 DE Schweisspunkt-Fräasersatz
 RU Набор сверл для точечной сварки
 CZ Frézy pro bodové sváry
 HU Ponthegesztés lefűró készlet
 RO Set burghie pt. puncte de sudură
 FR Forets à dépointer les points soudure
 IT Set di alesatori per punti di saldatura
 ES Juego de brocas para puntos de soldadura
 CN 点焊钻



Ø 6.5, 8, 10 mm

3 PCS 
 COBALT COATED
POKRYTE
KOBALTEM

YATO Ø [mm] 
 YT-28921 6.5, 8, 10 50

EN Combination edge setter / hole punch pliers
 PL Dziurkarko-felcarka
 DE Kombinierte Absetzange Lochzange
 RU Дырокол, кромкогиб
 CZ Falcovačka a děrovačka
 HU Lyukasztó peremező fogó

RO Cleste pt. fasonat si gaurit tabla
 FR Pince spéciale perforatrice carrosserie
 IT Combinazione: bordo setter / pinza perforare
 ES Solapadora y ponchadora manual
 CN 折边打孔钳



EN Adjustable angle welding magnet
 PL Wspomnik magnetyczny spawalniczy regulowany
 DE Verstellbarer Magnet-Werkstückhalter
 RU Регулируемый магнит заварки угла
 CZ Plohoovací magnetický držák ke svařování
 HU Állítható, mágneses, hegesztő támasz

RO Dispozitiv magnetic reglabil pt. sudura
 FR Support magnétique de soudure
 IT Supporto della saldatura magnetico
 ES Soporte magnético de soldadura, ajustable
 CN 焊接磁铁



 360°





 360°

YATO Lifting capacity / Udźwig [kg] Dimensions / Wymiary [mm] 
 YT-0862 2x22.5 85x65x22 6

13 mm

 22 mm 20 mm



YATO 
 YT-21582 10

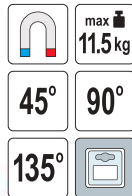

EN Magnetic welding holder
PL Kątownik magnetyczny spawalniczy
DE Magnet-Werkstückhalter
RU Магнитная струбцина заварки
CZ Magnetický úhelník ke svařování
HU Mágneses, hegesztő szögvas
RO Dispozitiv magnetic fixare pt. sudura
FR Support magnétique de soudure
IT Angolo magnetico da saldatura
ES Escuadra magnética de soldadura
CN 焊接磁铁



YATO 	Lifting capacity / Udźwig [kg]	Dimensions / Wymiary [mm]	
YT-0863	11.5	82x120x13	6/48

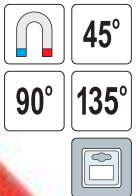

EN Magnetic welding holder
PL Kątownik magnetyczny spawalniczy
DE Magnet-Werkstückhalter
RU Магнитная струбцина заварки
CZ Magnetický úhelník ke svařování
HU Mágneses, hegesztő szögvas
RO Dispozitiv magnetic fixare pt. sudura
FR Support magnétique de soudure
IT Angolo magnetico da saldatura
ES Escuadra magnética de soldadura
CN 焊接磁铁

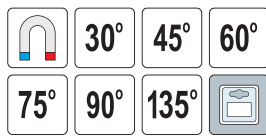

YATO 	Lifting capacity / Udźwig [kg]	Hole diameter / Średnica otworu [mm]	Dimensions / Wymiary [mm]	
YT-0864	22.5	18	102x155x17	6/30
YT-0865	34	46	122x190x25	6/18

EN Magnetic welding holder
PL Kątownik magnetyczny spawalniczy
DE Magnet-Werkstückhalter
RU Магнитная струбцина заварки
CZ Magnetický úhelník ke svařování
HU Mágneses, hegesztő szögvas
RO Dispozitiv magnetic fixare pt. sudura
FR Support magnétique de soudure
IT Triangolo magnetico da saldatura con interruttore
ES Escuadra magnética de soldadura
CN 焊接磁铁



YATO 	Lifting capacity / Udźwig [kg]	Dimensions / Wymiary [mm]	
YT-0866	11.5	64x95x14	6/24
YT-0867	34	111x136x24	6/18

EN Mini welding magnet holder set
PL Zestaw spawalniczych kątowników magnetycznych mini
DE Mini-Magnetschweißwinkel-Set
RU Набор сварочных магнитных угловых профилей мини
CZ Sada svařovacích magnetických úhelníků mini
HU Mini mágneses hegesztési derékszög készlet
RO Set minimagneti pt. sudura
FR Kit de cornières magnétiques de soudage mini
IT Set di posizionatori magnetici mini per saldatura
ES Juego de escuadras de soldadura magnéticas mini
CN 迷你磁性电焊架

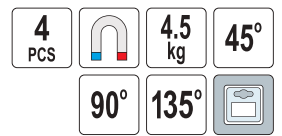

YATO 	Lifting capacity / Udźwig [kg]	Dimensions / Wymiary [mm]	
YT-08677	4.5	43x72x12	12/36

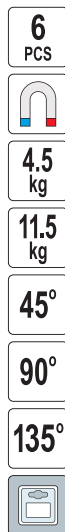

EN Welding magnet holder set
PL Zestaw spawalniczych kątowników magnetycznych
DE Magnetschweißwinkel-Set
RU Набор сварочных магнитных угловых профилей
CZ Sada svařovacích magnetických úhelníků
HU Mágneses hegesztési derékszög készlet
RO Set magneti pt. sudura
FR Kit de cornières magnétiques de soudage
IT Set di posizionatori magnetici per saldatura
ES Juego de escuadras de soldadura magnéticas
CN 磁性电焊架

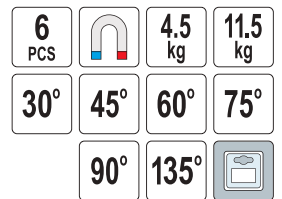
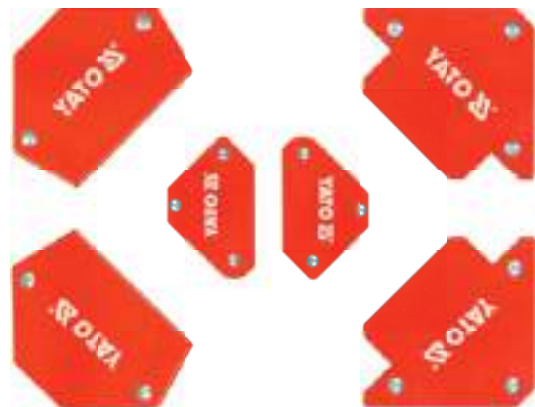

YATO 	Lifting capacity / Udźwig [kg]	Dimensions / Wymiary [mm]	
YT-08678	4.5, 11.5	43x72x12, 82x118x14	6/18

EN Welding magnet holder set
PL Zestaw spawalniczych kątowników magnetycznych
DE Magnetschweißwinkel-Set
RU Набор сварочных магнитных угловых профилей
CZ Sada svařovacích magnetických úhelníků
HU Mágneses hegesztési derékszög készlet
RO Set magneti pt. sudura
FR Kit de cornières magnétiques de soudage
IT Set di posizionatori magnetici per saldatura
ES Juego de escuadras de soldadura magnéticas
CN 焊接定位器套装



YATO 	Lifting capacity / Udźwig [kg]	Dimensions / Wymiary [mm]	
YT-08679	4.5, 11.5	43x72x12, 68x102x14, 82x118x14	10

- EN Magnetic welding holder set
- PL Zestaw magnetycznych uchwytów spawalniczych
- DE Magnetschweißhalter-Set
- RU Комплект магнитных сварочных ручек
- CZ Sada magnetických svařovacích úchytů
- HU Mágneses hegesztő tartó készlet
- RO Set suporti magnetici sudura
- FR Kit positionneur magnétique de soudure
- IT Kit di pinze magnetiche per saldatura
- ES Set de portaelectrodos magnéticos
- CN 焊接磁铁

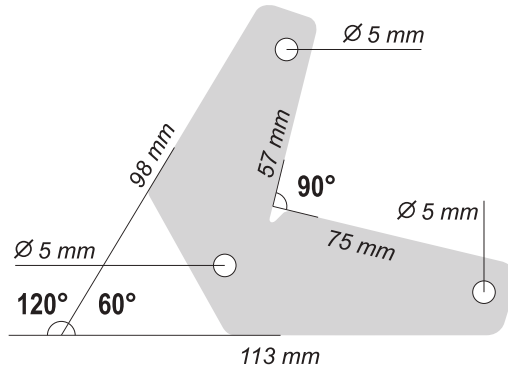

2
PCS 

60° 90°

120° 

YATO 	Lifting capacity / Udźwig [kg]	Size / Rozmiar [mm]	
YT-08721	10	98x113	6/24

- EN Magnetic welding holder set
- PL Zestaw magnetycznych uchwytów spawalniczych
- DE Magnetschweißhalter-Set
- RU Комплект магнитных сварочных ручек
- CZ Sada magnetických svařovacích úchytů
- HU Mágneses hegesztő tartó készlet
- RO Set suporti magnetici sudura
- FR Kit positionneur magnétique de soudure
- IT Kit di pinze magnetiche per saldatura
- ES Set de portaelectrodos magnéticos
- CN 焊接磁铁

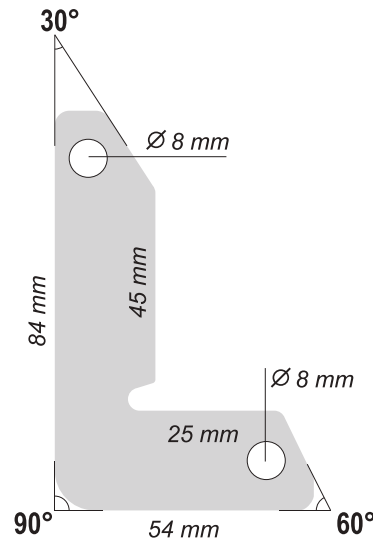
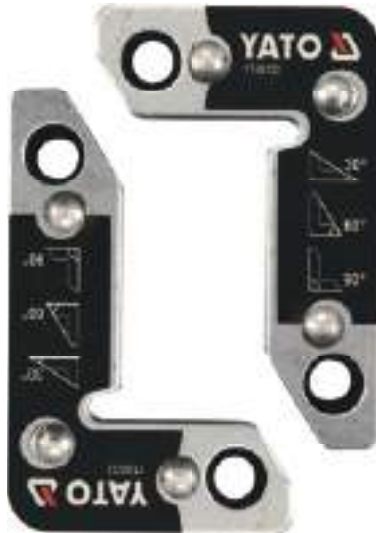

2
PCS 

30°

60° 90° 

YATO 	Lifting capacity / Udźwig [kg]	Size / Rozmiar [mm]	
YT-08722	25	54x84	10/40

- EN Magnetic welding holder set
- PL Zestaw magnetycznych uchwytów spawalniczych
- DE Magnetschweißhalter-Set
- RU Комплект магнитных сварочных ручек
- CZ Sada magnetických svařovacích úchytů
- HU Mágneses hegesztő tartó készlet
- RO Set suporti magnetici sudura
- FR Kit positionneur magnétique de soudure
- IT Kit di pinze magnetiche per saldatura
- ES Set de portaelectrodos magnéticos
- CN 焊接磁铁

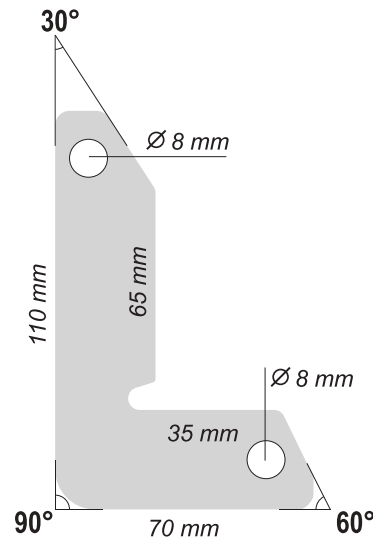

2
PCS 

30°

60°

90° 

YATO 	Lifting capacity / Udźwig [kg]	Size / Rozmiar [mm]	
YT-08723	32	70x110	8/32

- EN Magnetic welding ground
- PL Spawalniczy zacisk uziemiający
- DE Schweißerdungsklemme
- RU Сварочный зажим заземляющий
- CZ Svařovací svorka zemnicí
- HU Földelő csatlakozó hegesztőhöz
- RO Suport sudura magnetic
- FR Pince de masse pour soudure
- IT Morsetti di terra per saldatura
- ES Pinza de tierra para soldadura
- CN 磁性焊接接地夹



YT-08625



6/24

- EN MIG torch magnetic holder
- PL Podstawa magnetyczna do uchwytu MIG
- DE Magnetsockel für MIG-Halter
- RU Магнитная подставка для держателя MIG
- CZ Magnetický podstavec k držáku MIG
- HU Mágneses alátét MIG fogantyúhoz
- RO Suport magnetic pt. lampa MIG
- FR Base magnétique pour le support MIG
- IT Supporto per pistola MIG con base magnetica
- ES Base magnética para el soporte MIG
- CN 焊枪支架



- EN TIG torch magnetic holder
- PL Podstawa magnetyczna do uchwytu TIG
- DE Magnetsockel für TIG-Halter
- RU Магнитная подставка для держателя TIG
- CZ Magnetický podstavec k držáku TIG
- HU Mágneses alátét TIG fogantyúhoz
- RO Suport magnetic pt. lampa TIG
- FR Base magnétique pour le support TIG
- IT Supporto per pistola TIG con base magnetica
- ES Base magnética para el soporte TIG
- CN 氩弧焊焊枪支架



YT-08710



12



YT-08711



















12

Memo

18

**Power & gasoline tools
Elektronarzędzia
i narzędzia spalinowe**





<p>Cordless tools Narzędzia akumulatorowe</p> <p style="text-align: right;">499-510</p> 	<p>Concrete vibrator sets & accessories Wibratory do betonu i akcesoria</p> <p style="text-align: right;">520</p> 
<p>Gasoline construction tools Budowlane narzędzia spalinowe</p> <p style="text-align: right;">511</p> 	<p>Paint & mortar mixers Mieszarki do zapraw i farb</p> <p style="text-align: right;">521</p> 
<p>Straight grinders Szlifierki proste</p> <p style="text-align: right;">511</p> 	<p>Circular saws & accessories Pilarki tarczowe i akcesoria</p> <p style="text-align: right;">521</p> 
<p>Angle grinders & accessories Szlifierki kątowe i akcesoria</p> <p style="text-align: right;">511-515</p> 	<p>Miter saws Ukośnice</p> <p style="text-align: right;">522-523</p> 
<p>Nibblers & accessories Nożyce do blachy i akcesoria</p> <p style="text-align: right;">515</p> 	<p>Bench tools Elektronarzędzia stołowe</p> <p style="text-align: right;">523</p> 
<p>Wall chasers Bruzdownice</p> <p style="text-align: right;">515</p> 	<p>Jig saws Wyrzynarki</p> <p style="text-align: right;">523</p> 
<p>Concrete cutters Przecinarki do betonu</p> <p style="text-align: right;">515</p> 	<p>Planers Strugi</p> <p style="text-align: right;">524</p> 
<p>Tile cutters Przecinarki do ceramiki</p> <p style="text-align: right;">516</p> 	<p>Routers Frezarki</p> <p style="text-align: right;">524</p> 
<p>Car polishers Polerki samochodowe</p> <p style="text-align: right;">516</p> 	<p>Belt sanders Szlifierki taśmowe</p> <p style="text-align: right;">525</p> 
<p>Cut-off machines Przecinarki do metalu</p> <p style="text-align: right;">516</p> 	<p>Sabre saws Piły szablaste</p> <p style="text-align: right;">525</p> 
<p>Drilling machines Wiertarki</p> <p style="text-align: right;">516-517</p> 	<p>Orbital sanders Szlifierki mimośrodowe</p> <p style="text-align: right;">525</p> 
<p>Drywall screwdrivers Wkrętarki do regipsów</p> <p style="text-align: right;">518</p> 	<p>Finishing sanders Szlifierki oscylacyjne</p> <p style="text-align: right;">525</p> 
<p>Diamond drills Wiertnice diamentowe</p> <p style="text-align: right;">518</p> 	<p>Burnishing machines & accessories Satyniarki i akcesoria</p> <p style="text-align: right;">525-526</p> 
<p>Rotary hammers Młotowiertarki</p> <p style="text-align: right;">518-519</p> 	<p>Drywall sanders & accessories Szlifierki do gładzi i tynków oraz akcesoria</p> <p style="text-align: right;">526-527</p> 
<p>Demolition hammers Młoty wyburzeniowe</p> <p style="text-align: right;">519</p> 	<p>Painting tools & accessories Narzędzia do malowania i akcesoria</p> <p style="text-align: right;">528-529</p> 

Multi-purpose oscillating tools Wielofunkcyjne narzędzia oscylacyjne	
529	

Vacuum cleaners & accessories Odkurzacze i akcesoria	
530-532	

Wallpaper strippers Parownice do tapet	
532	

Knives Noże	
532	

Hot air guns Opalarki	
533-534	

Blowers Dmuchawy	
534	

Glue guns Pistolety do klejenia	
534	

Generators Generatory	
535	

Heaters Nagrzewnice	
535-536	

Pumps & accessories Pompy i akcesoria	
537-539	

Pressure washers Myjki ciśnieniowe	
539	

Cordless garden tools & accessories Ogrodowe narzędzia akumulatorowe i akcesoria	
540-545	

Cordless pressure washers Akumulatorowe myjki ciśnieniowe	540
Cordless blowers Dmuchawy akumulatorowe	540
Cordless sprayers Spryskiwacze akumulatorowe	540

Cordless grass trimmers & accessories Akumulatorowe wykasarki i akcesoria	541
Cordless pruning shears Sekatory akumulatorowe	542
Cordless grass and shrub shears Akumulatorowe nożyce do trawy i krzewów	542
Cordless hedge trimmers Akumulatorowe nożyce do żywopłotu	542
Cordless chainsaws Akumulatorowe piłarki łańcuchowe	544
Cordless lawn mowers Kosiarki akumulatorowe	545

Electric garden tools Ogrodowe narzędzia elektryczne	
546-548	

Electric grass trimmers Wykasarki elektryczne	546
Electric chainsaws Piłarki elektryczne	546
Electric lawn mowers Kosiarki elektryczne	546
Electric tillers Glebogryzarki elektryczne	547
Electric scarifiers Wertykulatory elektryczne	547
Electric brushes Szczotki elektryczne	547
Electric blowers Dmuchawy elektryczne	547
Accessories Akcesoria	548

Gasoline garden tools & accessories Ogrodowe narzędzia spalinowe i akcesoria	
548-557	

Gasoline sprayers Opryskiwacze spalinowe	548
Gasoline earth augers & accessories Wiertnice glebowe i akcesoria	548
Gasoline chainsaws Piłarki spalinowe	549
Gasoline brushcutters Kosy spalinowe	549
Gasoline tillers Glebogryzarki spalinowe	549
Accessories Akcesoria	550

- EN Cordless precision screwdriver set
PL Precyzyjny wkrętak akumulatorowy z bitami
DE Präzisions-Akkuschrauber mit Bits
RU Прецизионная аккумуляторная отвертка с битами
CZ Přesný aku šroubovák s bity
HU Precíz akkumulátoros csavarozó bifejekkel
RO Set surubelnite electronica
FR Tournevis sans-fil de précision avec embouts
IT Cacciavite a batteria di precisione con punte
ES Atornillador de batería preciso con bits
CN 电动钟表批组套

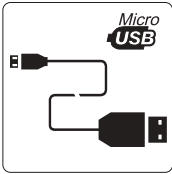

39 PCS 3.6 V 750mAh Li-Ion

− +

⊕ ⊖

⊙ ⊚

CrV LED LIGHT DIODE

Micro USB

- 2.5, 3.0, 3.5, 4.0, 4.5 mm (L=28 mm); CrV;
1.2, 1.6, 2.0, 2.4, 3.0 mm (L=28 mm); CrV;
PH000, PH00, PH0, PH1 x2 (L=28 mm); CrV;
PZ0 x2, PZ1 x2 (L=28 mm); CrV;
T4, T5, T6, T7, T8, T9, T10 (L=28 mm); CrV;
1.5, 2.0, 2.5, 3.0, 4.0 mm (L=28 mm); CrV;
S0, S1, S2, S3 (L=28 mm); CrV;
60 mm; CrV;
120 mm; CrV

$L_{PA} = 45,6 \pm 3,0$ dB; $L_{WA} = 56,6 \pm 3,0$ dB; $a_h = 0,21 \pm 1,5$ m/s²

YATO	[V d.c.]	
YT-27930	3.6	8

- EN Cordless drill/driver
PL Akumulatorowa wiertarko-wkrętarka
DE Akku-Bohrschrauber
RU Аккумуляторная дрель-шуруповерт
CZ Akumulatorový vrtací šroubovák
HU Akkus fúró-csavarozó
RO Mașină de găurit și înșurubat cu acumulator
FR Perceuse-visseuse sans-fil
IT Trapano avvitatore a batteria
ES Taladro atornillador a batería
CN 充电式电钻

12 V Li-Ion 30 Nm 0-400 min⁻¹ 0-1300 min⁻¹

0.8-10mm 2.0 Ah 1h

⚡ 🔁 🔋

- EN Cordless angle grinder
PL Akumulatorowa szlifierka kątowna
DE Akku-Winkelschleifer
RU Аккумуляторная угловая шлифмашина
CZ Akumulatorová úhlová bruska
HU Akkus sarokcsiszoló
RO Polizor unghiular cu acumulator
FR Meuleuse angulaire sans-fil
IT Smerigliatrice angolare a batteria
ES Amoladora angular a batería
CN 充电式角磨

12 V Li-Ion 19500 min⁻¹ 76x10 mm BRUSHLESS MOTOR SILK BEZ-SZCZOTKOWY

🔋

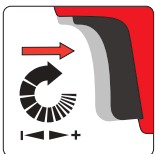

$L_{PA} = 71,50 \pm 5,0$ dB; $L_{WA} = 82,50 \pm 5,0$ dB; $a_h = 2,70 \pm 1,5$ m/s²

YATO	[V d.c.]	
YT-82901	12	5



- Spindle lock for easy blade change
- Blokada wrzeciona dla łatwej wymiany tarczy

$L_{PA} = 68,5 \pm 3,0$ dB; $L_{WA} = 79,5 \pm 3,0$ dB; $a_h = 1,23 \pm 1,5$ m/s²

YATO	[V d.c.]	
YT-82905	12	5

Battery not included
Ohne Akku / Bez akumulatora
Bez ładowarki / Bez aku
Akumulator nekadil
Fără baterie / Sans batterie
Senza batteria / Sin batería
没有电池

EN Cordless ratchet
 PL Grzechotka akumulatorowa
 DE Akku-Ratsche
 RU Аккумуляторные импульсная трещотка
 CZ Akumulátorová ráčna
 HU Akkus ütvecsavarozó

RO Șurubelniță cu impact cu acumulator
 FR Clé à cliquet sans-fil
 IT Cricchetto a batteria
 ES Llave de carraca a batería
 CN 充电式扳手

12V
Li-Ion

3/8"
9.5 mm

45 Nm

0-250 min⁻¹

2.0 Ah

1h

IMPACT FUNCTION
FUNKCJA UDARU



3/8" (9.5 mm): 12, 13, 14, 17 mm;
 1/2" (12.7 mm)

L_{pa} = 78,66 ± 3,0 dB; L_{wa} = 89,66 ± 3,0 dB; a_h = 2,898 ± 1,5 m/s²

YATO	[V d.c.]	
YT-82902	12	10

EN Cordless polisher
 PL Polerka akumulatorowa
 DE Akku-Polierer
 RU Аккумуляторная полировальная машина
 CZ Akumulátorová leštička
 HU Vezeték nélküli polírozó
 RO Aparat polisat cu acumulator
 FR Polisseuse sans-fil
 IT Lucidatrice a batteria
 ES Pulidora a batería
 CN 充电式抛光机

12V
Li-Ion

5/16"
8 mm

0-2800 min⁻¹
0-8300 min⁻¹

80 mm

2.0 Ah

1h



L_{pa} = 78,6 ± 3,0 dB; L_{wa} = 89,6 ± 3,0 dB; a_h = 4,213 ± 1,5 m/s²

YATO	[V d.c.]	
YT-82903	12	5

EN Battery
 PL Akumulator
 DE Akkumulator
 RU Аккумулятор
 CZ Akumulátor
 HU Akkumulátor

RO Acumulatorul
 FR Batterie
 IT Batteria
 ES Bateria
 CN 锂电池包



12V
Li-Ion

2.0 Ah

1h

YATO	[V d.c.]	
YT-82909	12	40

EN Battery
 PL Akumulator
 DE Akkumulator
 RU Аккумулятор
 CZ Akumulátor
 HU Akkumulátor

RO Acumulatorul
 FR Batterie
 IT Batteria
 ES Bateria
 CN 锂电池包



12V
Li-Ion

4.0 Ah

2h

YATO	[V d.c.]	
YT-82910	12	20

EN Battery charger
 PL Ładowarka
 DE Ladegerät
 RU Зарядное устройство
 CZ Nabíječka
 HU Töltő

RO Încărcător
 FR Chargeur
 IT Caricabatteria
 ES Cargador
 CN 充电器



110-240V~
50-60Hz

for 12V
Li-Ion

YATO	[V d.c.]	
YT-82912	12	20

EN Cordless drill/driver
PL Akumulatorowa wiertarko-wkrętarka
DE Akku-Bohrschrauber
RU Аккумуляторная дрель-шурупверт
CZ Akumulátorový vrtací šroubovák
HU Akkus fűrés-csavarozó

RO Mașină de găurit și înșurubat cu acumulator
FR Perceuse-visseuse sans-fil
IT Trapano avvitatore a batteria
ES Taladro atornillador a batería
CN 充电式电钻

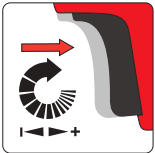

$L_{pa} = 71,0 \pm 3,0$ dB; $L_{wa} = 82,0 \pm 3,0$ dB; $a_n = 3,0 \pm 1,5$ m/s²

18V
Li-Ion

YATO [V d.c.]	Battery capacity / Pojemność akumulatora [mAh]	⚡ [h]	Battery quantity / Liczba akumulatorów w zestawie	📦
YT-82780	18 2000	1	1	5
YT-82781	18 -	-	brak	5

EN Cordless drill/driver
PL Akumulatorowa wiertarko-wkrętarka
DE Akku-Bohrschrauber
RU Аккумуляторная дрель-шурупверт
CZ Akumulátorový vrtací šroubovák
HU Akkus fűrés-csavarozó

RO Mașină de găurit și înșurubat cu acumulator
FR Perceuse-visseuse sans-fil
IT Trapano avvitatore a batteria
ES Taladro atornillador a batería
CN 充电式电钻

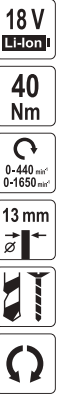

MABUCHI MOTOR SILNIK

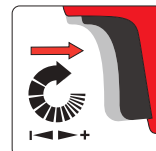

18V
Li-Ion

$L_{pa} = 71,0 \pm 3,0$ dB; $L_{wa} = 82,0 \pm 3,0$ dB; $a_n = 3,0 \pm 1,5$ m/s²

YATO [V d.c.]	Battery capacity / Pojemność akumulatora [mAh]	⚡ [h]	Battery quantity / Liczba akumulatorów w zestawie	📦
YT-82784	18 3000	1.5	2	4
YT-82782	18 2000	1	1	4
YT-82783	18 -	-	brak	5

EN Cordless impact drill/driver
PL Akumulatorowa wiertarko-wkrętarka udarowa
DE Akku-Schlagbohrschrauber
RU Аккумуляторный ударный дрель-шурупверт
CZ Akumulátorový nárazový šroubovák s příklepem
HU Akkus ütvefűrés-csavarozó

RO Mașină de găurit și înșurubat cu percuteție cu acumulator
FR Perceuse-visseuse percussion sans-fil
IT Trapano avvitatore a percussione a batteria
ES Taladro atornillador con percusión a batería
CN 充电式冲击钻

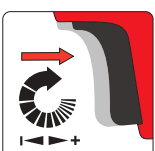
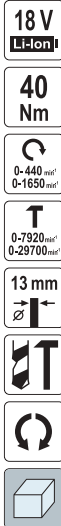

$L_{pa} = 82,0 \pm 3,0$ dB; $L_{wa} = 93,0 \pm 3,0$ dB; $a_n = 3,0 \pm 1,5 / 9,89 \pm 1,5$ m/s²

18V
Li-Ion

YATO [V d.c.]	Battery capacity / Pojemność akumulatora [mAh]	⚡ [h]	Battery quantity / Liczba akumulatorów w zestawie	📦
YT-82786	18 2000	1	1	5
YT-82787	18 -	-	brak	5

EN Cordless impact drill/driver
PL Akumulatorowa wiertarko-wkrętarka udarowa
DE Akku-Schlagbohrschrauber
RU Аккумуляторный ударный дрель-шурупверт
CZ Akumulátorový nárazový šroubovák s příklepem
HU Akkus ütvefűrés-csavarozó

RO Mașină de găurit și înșurubat cu percuteție cu acumulator
FR Perceuse-visseuse percussion sans-fil
IT Trapano avvitatore a percussione a batteria
ES Taladro atornillador con percusión a batería
CN 充电式冲击钻

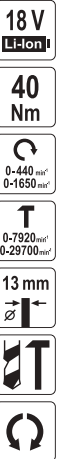

MABUCHI MOTOR SILNIK

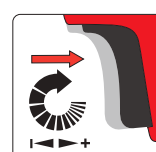

18V
Li-Ion

$L_{pa} = 71,0 \pm 3,0$ dB; $L_{wa} = 82,0 \pm 3,0$ dB; $a_n = 3,0 \pm 1,5 / 9,89 \pm 1,5$ m/s²

YATO [V d.c.]	Battery capacity / Pojemność akumulatora [mAh]	⚡ [h]	Battery quantity / Liczba akumulatorów w zestawie	📦
YT-82788	18 2000	1	1	4
YT-82789	18 -	-	brak	5

EN Brushless cordless drill/driver
 PL Bezszczotkowa wiertarko-wkrętarka akumulatorowa
 DE Bürstenloser Akku-Bohrschrauber
 RU Бесщеточный аккумуляторный дрель-шуруповерт
 CZ Bezkartáčový akumulátorový vrtací šroubovák s příklepem
 HU Akkus fűró-csavarozó szénkefe nélkül
 RO Mașină de găurit și înșurubat cu acumulator fără perii
 FR Perceuse-visseuse sans-fil sans charbon
 IT Trapano avvitatore senza spazzole a batteria
 ES Taladro atornillador a batería sin escobillas
 CN 充电式无刷冲击钻

18V
Li-Ion

42 Nm

0-600 min⁻¹
0-2000 min⁻¹

13 mm

BRUSHLESS MOTOR
SILNIK BEZ SZCZOTKOWY

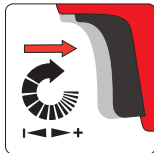

18V
Li-Ion

$L_{pka} = 74,0 \pm 3,0$ dB; $L_{max} = 85,0 \pm 3,0$ dB; $a_n = 3,0 \pm 1,5$ m/s²

YATO [V d.c.]	Battery capacity / Pojemność akumulatora [mAh]	Battery quantity / Liczba akumulatorów w zestawie	Package
YT-82794	18 2000	1	4
YT-82795	18 -	-	brak 5

EN Brushless cordless drill/driver
 PL Bezszczotkowa wiertarko-wkrętarka akumulatorowa
 DE Bürstenloser Akku-Bohrschrauber
 RU Бесщеточный аккумуляторный дрель-шуруповерт
 CZ Bezkartáčový akumulátorový vrtací šroubovák s příklepem
 HU Akkus fűró-csavarozó szénkefe nélkül
 RO Mașină de găurit și înșurubat cu acumulator fără perii
 FR Perceuse-visseuse sans-fil sans charbon
 IT Trapano avvitatore senza spazzole a batteria
 ES Taladro atornillador a batería sin escobillas
 CN 充电式无刷冲击钻

18V
Li-Ion

42 Nm

0-600 min⁻¹
0-2000 min⁻¹

13 mm

BRUSHLESS MOTOR
SILNIK BEZ SZCZOTKOWY

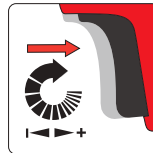

18V
Li-Ion

$L_{pka} = 94,0 \pm 3,0$ dB; $L_{max} = 95,0 \pm 3,0$ dB; $a_n = 3,0 \pm 1,5 / 9,6 \pm 1,5$ m/s²

YATO [V d.c.]	Battery capacity / Pojemność akumulatora [mAh]	Battery quantity / Liczba akumulatorów w zestawie	Package
YT-82796	18 2000	1	4
YT-82797	18 -	-	brak 5

EN Brushless cordless drill/driver
 PL Bezszczotkowa wiertarko-wkrętarka akumulatorowa
 DE Bürstenloser Akku-Bohrschrauber
 RU Бесщеточный аккумуляторный дрель-шуруповерт
 CZ Bezkartáčový akumulátorový vrtací šroubovák s příklepem
 HU Akkus fűró-csavarozó szénkefe nélkül
 RO Mașină de găurit și înșurubat cu acumulator fără perii
 FR Perceuse-visseuse sans-fil sans charbon
 IT Trapano avvitatore senza spazzole a batteria
 ES Taladro atornillador a batería sin escobillas
 CN 充电式无刷冲击钻

18V
Li-Ion

75 Nm

0-500 min⁻¹
0-2100 min⁻¹

13 mm

BRUSHLESS MOTOR
SILNIK BEZ SZCZOTKOWY



18V
Li-Ion

$L_{pka} = 87,0 \pm 5,0$ dB; $L_{max} = 98,0 \pm 5,0$ dB; $a_n = 6,23 \pm 1,5 / 4,37 \pm 1,5$ m/s²

YATO [V d.c.]	Battery capacity / Pojemność akumulatora [mAh]	Battery quantity / Liczba akumulatorów w zestawie	Package
YT-82791	18 3000	1.5	3
YT-82790	18 3000	1.5	4
YT-82792	18 -	-	brak 6

EN Cordless impact screwdriver
 PL Akumulatorowa zakrętkarka udarowa
 DE Akku-Schlagschrauber
 RU Аккумуляторный ударный винтоверт
 CZ Akumulátorový rázový utahovák
 HU Akkus ütvecsavarozó
 RO Șurubelniță cu impact cu acumulator
 FR Boulonneuse sans-fil
 IT Avvitatore a percussione a batteria
 ES Atornillador de impacto a batería
 CN 充电式冲击螺丝批

18V
Li-Ion

1/4" 6.3mm

160 Nm

0-3000 min⁻¹

BRUSHLESS MOTOR
SILNIK BEZ SZCZOTKOWY

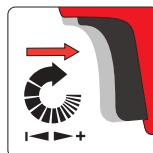

18V
Li-Ion

$L_{pka} = 82,0 \pm 3,0$ dB; $L_{max} = 93,0 \pm 3,0$ dB; $a_n = 8,15 \pm 1,5$ m/s²

YATO [V d.c.]	Battery capacity / Pojemność akumulatora [mAh]	Battery quantity / Liczba akumulatorów w zestawie	Package
YT-82800	18 2000	1	5
YT-82801	18 -	-	brak 5

EN Cordless impact screwdriver
PL Akumulatorowa zakrętkarka udarowa
DE Akku-Schlagschrauber
RU Аккумуляторный ударный гайковёрт
CZ Akumulátorový rázový uťahovák
HU Akkus ütvecsavarozó
RO Şurubelniţă cu impact cu acumulator
FR Boulonreuse sans-fil
IT Avvitatore a percussione a batteria
ES Atornillador de impacto a batería
CN 充电式无刷冲击扳手

18V Li-Ion | 1/2" 12.7mm | 250 Nm | T 0-4400 min⁻¹ | 0-2600 min⁻¹ | 3.0 Ah | 1.5h | LED CHARGE INDICATOR WSKAZNIK NAŁADOWANIA BATERII



18V Li-Ion

$L_{pa} = 86.0 \pm 3.0$ dB; $L_{wa} = 97.0 \pm 3.0$ dB; $a_n = 7.58 \pm 1.5$ m/s²

YATO [V d.c.]	Battery capacity / Pojemność akumulatora [mAh]	Battery quantity / Liczba akumulatorów w zestawie	Package
YT-82802	18 2000	1	4
	-	-	5

EN Cordless impact wrench
PL Akumulatorowy klucz udarowy
DE Akku-Drehschlagschrauber
RU Аккумуляторный ударный гайковёрт
CZ Akumulátorový rázový uťahovák
HU Akkus ütvecsavarozó
RO Şurubelniţă cu impact cu acumulator
FR Boulonreuse sans-fil
IT Chiave a percussione a batteria
ES Atornillador de impacto a batería
CN 充电式冲击扳手

18V Li-Ion | 1/2" 12.7mm | 300 Nm | T 0-2700 min⁻¹ | 0-2200 min⁻¹ | LED CHARGE INDICATOR WSKAZNIK NAŁADOWANIA BATERII

17, 19, 21, 23 mm

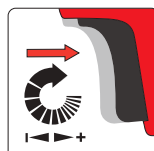

18V Li-Ion

$L_{pa} = 84.0 \pm 3.0$ dB; $L_{wa} = 95.0 \pm 3.0$ dB; $a_n = 9.09 \pm 1.5$ m/s²

YATO [V d.c.]	Battery capacity / Pojemność akumulatora [mAh]	Battery quantity / Liczba akumulatorów w zestawie	Package
YT-82804	18 2000	1	4
YT-82805	18 -	-	5

EN Cordless impact wrench
PL Akumulatorowy klucz udarowy
DE Akku-Drehschlagschrauber
RU Аккумуляторный ударный гайковёрт
CZ Akumulátorový rázový uťahovák
HU Akkus ütvecsavarozó
RO Şurubelniţă cu impact cu acumulator
FR Boulonreuse sans-fil
IT Chiave a percussione a batteria
ES Atornillador de impacto a batería
CN 充电式冲击扳手

18V Li-Ion | 1/2" 12.7mm | 700 Nm | T 0-5000 min⁻¹ | 0-2600 min⁻¹ | BRUSHLESS MOTOR SILNIK BEZ SZCZOTKOWY

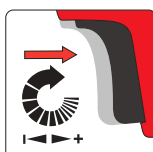

18V Li-Ion

$L_{pa} = 86.0 \pm 3.0$ dB; $L_{wa} = 97.0 \pm 3.0$ dB; $a_n = 7.58 \pm 1.5$ m/s²

YATO [V d.c.]	Battery capacity / Pojemność akumulatora [mAh]	Battery quantity / Liczba akumulatorów w zestawie	Package
YT-82806	18 3000	1.5	3
YT-828061	18 -	-	6

EN Cordless impact wrench
PL Akumulatorowy klucz udarowy
DE Akku-Drehschlagschrauber
RU Аккумуляторный ударный гайковёрт
CZ Akumulátorový rázový uťahovák
HU Akkus ütvecsavarozó
RO Şurubelniţă cu impact cu acumulator
FR Boulonreuse sans-fil
IT Chiave a percussione a batteria
ES Atornillador de impacto a batería
CN 充电式冲击扳手

18V Li-Ion | 3/4" 19mm | 2000 Nm | 0-1200 min⁻¹ 1650 min⁻¹ | T 0-2200 min⁻¹ | BRUSHLESS MOTOR SILNIK BEZ SZCZOTKOWY | LED CHARGE INDICATOR WSKAZNIK NAŁADOWANIA BATERII

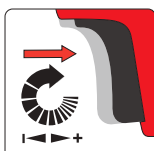
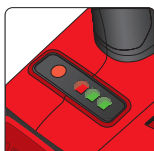

18V Li-Ion

$L_{pa} = 73.0 \pm 5.0$ dB; $L_{wa} = 81.0 \pm 5.0$ dB; $a_n = 9.00 \pm 1.5$ m/s²

YATO [V d.c.]	Battery capacity / Pojemność akumulatora [mAh]	Battery quantity / Liczba akumulatorów w zestawie	Package
YT-828075	18 4000	2	2
YT-828076	18 -	-	4

- EN Cordless screwdriver
- PL Wkręćak akumulatorowy
- DE Akku-Schrauber
- RU Аккумуляторный шурупверт
- CZ Utahovák akumulátorový
- HU Akkumulátoros csavarbehajtó
- RO Șurubelniță cu acumulator
- FR Tournevis sans-fil
- IT Avvitatore a batteria
- ES Herramienta de resistencia para soldar
- CN 充电式螺丝批

3.6 V 1300mAh Li-Ion!	3.0 Nm	230 min ⁻¹	
WARNING AREA LIGHT OSWIELENIE OBSZARU PRACY		LED CHARGE INDICATOR WSKAZNIK NAŁADOWANIA BATERII	

- EN Cordless glue gun
- PL Akumulatorowy pistolet do klejenia
- DE Heissklebepistole
- RU Пистолет для клея
- CZ Pistole na lepení
- HU Ragasztópisztoly
- RO Pistol pt. lipit
- FR Pistolet à colle sans-fil
- IT Pistola colla
- ES Pistola de cola
- CN 充电式胶枪

18 V Li-Ion!	25 g/min	3x Ø 11mm	≥ 60 min
2.0 Ah	1h		



$L_{pA} = 62,0 \pm 3,0$ dB; $L_{wA} = 73,0 \pm 3,0$ dB; $a_n = 0,39 \pm 1,5$ m/s²

YATO	[V d.c.]	
YT-82760	3.6	20



Fitting glue sticks: see chapter 12
Pasujące wkłady klejowe: patrz rozdział 12

18V
Li-Ion!

YATO	[V d.c.]	
YT-82854	18	10

- EN Cordless car air compressor
- PL Akumulatorowy kompresor samochodowy
- DE Akku-Auto-Kompressor
- RU Компрессор автомобильный аккумуляторный
- CZ Akumulátorový automobilový kompresor
- HU Autókompresszor akkumulátoros
- RO Compresor auto cu acumulator
- FR Compresseur de voiture sans-fil
- IT Compresore a batteria per auto
- ES Compresor de coche de batería
- CN 无绳车载空气压缩机

36 V 2x 18V Li-Ion!	8 bar	98 l/min
6L		

- EN Cordless car air compressor
- PL Akumulatorowy kompresor samochodowy
- DE Akku-Auto-Kompressor
- RU Компрессор автомобильный аккумуляторный
- CZ Akumulátorový automobilový kompresor
- HU Autókompresszor akkumulátoros
- RO Compresor auto cu acumulator
- FR Compresseur de voiture sans-fil
- IT Compresore a batteria per auto
- ES Compresor de coche de batería
- CN 无绳车载空气压缩机

18 V Li-Ion!	12V	11 bar
LED LIGHTING OSWIELENIE	LCD BACKLIGHT POSWIELENIE	

- Pressure hose
- Tire inflation gun
- Wąż ciśnieniowy
- Pistolet do pompowania kół



18V
Li-Ion!

$L_{pA} = 80,0 \pm 3,0$ dB; $L_{wA} = 90,7 \pm 3,0$ dB

YATO	[V d.c.]	Battery capacity / Pojemność akumulatora [mAh]	[h]	Battery quantity / Liczba akumulatorów w zestawie	
YT-23241	36 (18 x2)	3000	1.5	2	1
YT-23242	36 (18 x2)	-	-	brak	1



18V
Li-Ion!

$L_{pA} = 71,2 \pm 3,0$ dB; $L_{wA} = 82,2 \pm 3,0$ dB; $a_n = 9,75 \pm 1,5$ m/s²

YATO	[V d.c.]	Battery capacity / Pojemność akumulatora [mAh]	[h]	Battery quantity / Liczba akumulatorów w zestawie	
YT-23247	18	3000	1.5	1	4
YT-23248	18	-	-	brak	4

EN Cordless inflator
PL Pompka akumulatorowa
DE Akku-Luftpumpe
RU Аккумуляторный насос
CZ Čerpadlo baterie
HU Akkumulátor szivattyú
RO Bateria pompei
FR Pompe à air sans-fil
IT Pompa a batteria
ES Bomba de batería
CN 充电式充气泵



18V Li-Ion
1.0 MPa
14 l/min
50 cm



18V
Li-Ion

$L_{pA} = 77,1 \pm 3,0$ dB; $L_{wA} = 85,1 \pm 3,0$ dB; $a_h = 2,33 \pm 1,5$ m/s²

YATO [V d.c.]	Battery capacity / Pojemność akumulatora [mAh]	⚡ [h]	Battery quantity / Liczba akumulatorów w zestawie	📦
YT-82894	18 2000	1	1	5
YT-82895	18 -	-	brak	5

EN Cordless grease gun
PL Smarownica akumulatorowa
DE Akku-Fettpresse
RU Шприц для смазки аккумуляторный
CZ Akumulátorový mazací lis
HU Akku zsíröz prés
RO Pistol de gresat cu acumulator
FR Pistolet graisseur sans-fil
IT Lubrificatore a batteria
ES Lubricador de batería
CN 无绳黄油枪

18V Li-Ion
62 MPa
284 g/min
76 cm
LED LIGHTING



18V
Li-Ion

$L_{pA} = 76,0 \pm 3,0$ dB; $L_{wA} = 86,0 \pm 3,0$ dB; $a_h = 0,5 \pm 1,5$ m/s²

YATO [V d.c.]	Battery capacity / Pojemność akumulatora [mAh]	⚡ [h]	Battery quantity / Liczba akumulatorów w zestawie	📦
YT-07020	18 3000	1.5	1	2
YT-07021	18 -	-	brak	2

EN Cordless stirrer
PL Mieszarka akumulatorowa
DE Akku-Rührwerk
RU Аккумуляторная мешалка
CZ Akumulátorové míchadlo
HU Akkus keverőgép
RO Agitator cu acumulator
FR Malaxeur sans-fil
IT Miscelatore a batteria
ES Citador de batería
CN 充电式搅拌机



18V
Li-Ion

$L_{pA} = 79,0 \pm 3,0$ dB; $L_{wA} = 90,0 \pm 3,0$ dB; $a_h = 4,76 \pm 1,5$ m/s²

YATO [V d.c.]	Battery capacity / Pojemność akumulatora [mAh]	⚡ [h]	Battery quantity / Liczba akumulatorów w zestawie	📦
YT-82880	18 2000	1	1	2
YT-82881	18 -	-	brak	2

EN Cordless caulking gun
PL Akumulatorowy wyciskacz do mas
DE Akku-Kartuschenpistole
RU Аккумуляторный пистолет для герметика
CZ Akumulátorová těsnicí pistole
HU Akkus kinyomó vázas masszázshoz
RO Pistol pt. etansare
FR Pistolet a feutrer sans-fil
IT Pistola applicatrice a batteria
ES Pistola para masilla a batería
CN 充电式填缝枪

18V Li-Ion
2000 N
0.5-8 mm/s
225mm



18V
Li-Ion

$L_{pA} = 80,0 \pm 3,0$ dB; $L_{wA} = 91,0 \pm 3,0$ dB; $a_h = 1,68 \pm 1,5$ m/s²

YATO [V d.c.]	Battery capacity / Pojemność akumulatora [mAh]	⚡ [h]	Battery quantity / Liczba akumulatorów w zestawie	📦
YT-82888	18 4000	2	1	5
YT-82889	18 -	-	brak	5

EN Cordless spray gun
PL Akumulatorowy pistolet malarski
DE Akkubetriebene Farbspritzpistole
RU Аккумуляторный покрасочный пистолет
CZ Akumulátorová malířská pistole
HU Akkumulátoros festékszór
RO Pistol de vopsit cu acumulator
FR Pistolet à peinture sans-fil
IT Pistola a batteria per verniciare
ES Pistola para pintar a batería
CN 充电式喷枪

18V Li-Ion
2.2 mm
1 l/min

1000 ml
4.0 Ah

2h



18V
Li-Ion

$L_{pA} = 72,1 \pm 3,0$ dB; $L_{wA} = 83,1 \pm 3,0$ dB; $a_h = 0,203 \pm 1,5$ m/s²

YATO [V d.c.]	📦
YT-82765	18 4

18V Li-Ion
0-650 min⁻¹
M14

18

18V
Li-Ion

EN Cordless circular saw
 PL Akumulatorowa pilarka tarczowa
 DE Akku-Handkreissäge
 RU Аккумуляторная циркулярная пила
 CZ Akumulátorová okružní pila
 HU Akkus körfűrész
 RO Ferăstrău circular cu acumulator
 FR Scie circulaire sans-fil
 IT Sega circolare a batteria
 ES Sierra circular a batería
 CN 充电式电圆锯

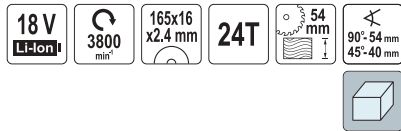

Fitting blades: see chapter 10
 Pasujące tarcze: patrz rozdział 10

$L_{pa} = 85,0 \pm 3,0$ dB; $L_{wa} = 96,0 \pm 3,0$ dB; $a_h = 5,33 \pm 1,5$ m/s²

18V
Li-Ion

YATO	[V d.c.]	Battery capacity / Pojemność akumulatora [mAh]	⚡ [h]	Battery quantity / Liczba akumulatorów w zestawie	📦
YT-82810	18	2000	1	1	2
YT-82811	18	-	-	brak	2

EN Cordless sabre saw
 PL Akumulatorowa pila szablata
 DE Akku-Säbelsäge
 RU Аккумуляторная сабельная пила
 CZ Akumulátorová pila ocaska
 HU Akkus szablyafűrész
 RO Ferăstrău sabie cu acumulator
 FR Scie sabre sans-fil
 IT Sega a gattuccio a batteria
 ES Sierra sable de batería
 CN 充电式往复锯



Fitting blades: see chapter 10
 Pasujące brzeszczyły: patrz rozdział 10

$L_{pa} = 81,0 \pm 3,0$ dB; $L_{wa} = 92,0 \pm 3,0$ dB; $a_h = 7,5 \pm 1,5 / 8,3 \pm 1,5$ m/s²

18V
Li-Ion

YATO	[V d.c.]	Battery capacity / Pojemność akumulatora [mAh]	⚡ [h]	Battery quantity / Liczba akumulatorów w zestawie	📦
YT-82814	18	2000	1	1	4
YT-82815	18	-	-	brak	4

EN Cordless multi-purpose oscillating tool
 PL Akumulatorowe wielofunkcyjne narzędzie oscylacyjne
 DE Akku-Multifunktionswerkzeug
 RU Аккумуляторный многофункциональный инструмент
 CZ Akumulátorová multifunkční pila
 HU Akkus multifunkcionális vágószerszám
 RO Mașină multifuncțională cu acumulator
 FR Découpeur-ponceur multifonctions sans-fil
 IT Utensile oscillante multifunzione a batteria
 ES Multiherramienta a batería
 CN 充电式摆动铲



18V
Li-Ion

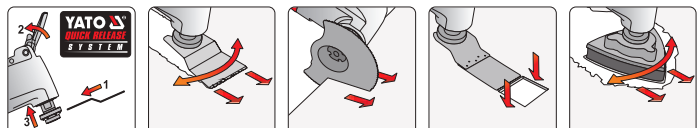

YATO	[V d.c.]	Battery capacity / Pojemność akumulatora [mAh]	⚡ [h]	Battery quantity / Liczba akumulatorów w zestawie	📦
YT-82818	18	2000	1	1	4
YT-82819	18	-	-	brak	4

$L_{pa} = 77,0 \pm 3,0$ dB; $L_{wa} = 88,0 \pm 3,0$ dB; $a_h = 4,68 \pm 1,5$ m/s²

EN Cordless jig saw
PL Akumulatorowa wyrzynarka
DE Akku-Stichsäge
RU Аккумуляторная лобковая пила
CZ Akumulátorová přimočará pila
HU Akkus szűrőfűrész
RO Ferăstrău vertical cu acumulator
FR Scie sauteuse sans-fil
IT Seghetto alternativo a batteria
ES Sierra de calar a batería
CN 充电式曲线锯



18V
Li-Ion

$L_{pa} = 76,0 \pm 3,0$ dB; $L_{wa} = 87,0 \pm 3,0$ dB; $a_n = 6,28 \pm 1,5 / 5,78 \pm 1,5$ m/s²

YATO	[V d.c.]	Battery capacity / Pojemność akumulatora [mAh]	⚡ [h]	Battery quantity / Liczba akumulatorów w zestawie	📦
YT-82822	18	2000	1	1	4
YT-82823	18	-	-	brak	5

EN Cordless band saw
PL Akumulatorowa pila taśmowa
DE Akku-Bandsäge
RU Аккумуляторная ленточная пила
CZ Akumulátorová pásová pila
HU Akkus szalagfűrész
RO Fierastrău cu banda cu acumulator
FR Scie à ruban sans-fil
IT Sega a nastro a batteria
ES Sierra de cinta a batería
CN 充电式带锯

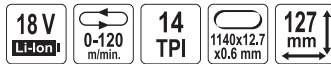

18V
Li-Ion

$L_{pa} = 82,0 \pm 3,0$ dB; $L_{wa} = 93,0 \pm 3,0$ dB; $a_n = 5,14 \pm 1,5 / 4,65 \pm 1,5$ m/s²

YATO	[V d.c.]	Battery capacity / Pojemność akumulatora [mAh]	⚡ [h]	Battery quantity / Liczba akumulatorów w zestawie	📦
YT-82187	18	4000	3	1	2
YT-82188	18	-	-	brak	2

EN Cordless angle grinder
PL Akumulatorowa szlifierka kątowa
DE Akku-Winkelschleifer
RU Аккумуляторная угловая шлифмашина
CZ Akumulátorová úhlová bruska
HU Akkus sarokcsiszoló
RO Polizor unghiular cu acumulator
FR Meuleuse angulaire sans-fil
IT Smerigliatrice angolare a batteria
ES Amoladora angular a batería
CN 充电式角磨



18V
Li-Ion

$L_{pa} = 88,0 \pm 3,0$ dB; $L_{wa} = 99,0 \pm 3,0$ dB; $a_n = 4,9 \pm 1,5$ m/s²

YATO	[V d.c.]	Battery capacity / Pojemność akumulatora [mAh]	⚡ [h]	Battery quantity / Liczba akumulatorów w zestawie	📦
YT-82828	18	3000	1.5	2	4
YT-82826	18	2000	1	1	4
YT-82827	18	-	-	brak	6

EN Cordless riveter
PL Nitownica akumulatorowa
DE Akku-Blindnietpistole
RU Аккумуляторный заклепочник
CZ Akumulátorová nýtovačka
HU Akkus popszegecsűző
RO Sculă de nituire cu acumulator
FR Riveteuse sans-fil
IT Rivettatrice a batteria
ES Remachadora a batería
CN 充电式铆钉枪



18V
Li-Ion

$L_{pa} = 81,0 \pm 3,0$ dB; $L_{wa} = 92,0 \pm 3,0$ dB; $a_n = 3,94 \pm 1,5$ m/s²

YATO	[V d.c.]	Battery capacity / Pojemność akumulatora [mAh]	⚡ [h]	Battery quantity / Liczba akumulatorów w zestawie	📦
YT-82955	18	3000	1.5	1	4
YT-82956	18	-	-	brak	6

EN Cordless straight grinder
PL Akumulatorowa szlifierka prosta
DE Akku-Geradschleifer
RU Аккумуляторная прямая шлифмашина
CZ Akumulátorová přímá bruska
HU Akkus egyenes csiszoló
RO Polizor drept cu acumulator
FR Meuleuse droite sans-fil
IT Smerigliatrice diritta a batteria
ES Amoladora recta a batería
CN 锂电直磨机



18V
Li-Ion

$L_{pa} = 78,0 \pm 3,0$ dB; $L_{wa} = 89,0 \pm 3,0$ dB; $a_n = 2,47 \pm 1,5$ m/s²

YATO	[V d.c.]	📦
YT-82824	18	10

EN Cordless angle grinder
PL Akumulatorowa szlifierka kątowa
DE Akku-Winkelschleifer
RU Аккумуляторная угловая шлифмашина
CZ Akumulátorová úhlová bruska
HU Akkus sarokcsiszoló
RO Polizor unghiular cu acumulator
FR Meuleuse angulaire sans-fil
IT Smerigliatrice angolare a batteria
ES Amoladora angular a batería
CN 充电式角磨



18V
Li-Ion

$L_{pa} = 89,0 \pm 3,0$ dB; $L_{wa} = 97,0 \pm 3,0$ dB; $a_n = 7,28 \pm 1,5$ m/s²

YATO	[V d.c.]	Battery capacity / Pojemność akumulatora [mAh]	⚡ [h]	Battery quantity / Liczba akumulatorów w zestawie	📦
YT-828295	18	4000	2	2	4
YT-828294	18	4000	2	1	6
YT-828293	18	-	-	brak	8

- EN Cordless grinders kit
- PL Zestaw szlifierek akumulatorowych
- DE Akku-Schleifgeräte-Set
- RU Набор аккумуляторных шлифовальных машин
- CZ Sada akumulátorových brusek
- HU Akkumulátoros csiszológép készlet
- RO Set polizoare cu acumulator
- FR Jeu de meuleuses sans-fil
- IT Kit di smerigliatrici a batteria
- ES Juego de amoladoras a batería
- CN 锂电角磨-直磨机套装

18V Li-Ion | 8000-26000 min⁻¹ | 6 mm | max ∅ 25 mm | ∅ 125 mm | 3000-8500 min⁻¹ | M14 | 4.0 Ah | 2h | SOFT START MIEKKI START | BRUSHLESS MOTOR SILNIK BEZ SZCZOTKOWY



18V Li-Ion

$L_{pa} = 78,0 \pm 3,0$ dB; $L_{wa} = 89,0 \pm 3,0$ dB; $a_h = 2,47 \pm 1,5$ m/s² (Straight grinder / Szlifierka prosta);
 $L_{pa} = 89,0 \pm 3,0$ dB; $L_{wa} = 97,0 \pm 3,0$ dB; $a_h = 7,28 \pm 1,5$ m/s² (Angle grinder / Szlifierka kątowa)

- EN Cordless polisher
- PL Polerka akumulatorowa
- DE Akku-Polierer
- RU Аккумуляторная полировальная машина
- CZ Akumulátorová leštička
- HU Vezeték nélküli polírozó
- RO Aparat polisat cu acumulator
- FR Polisseuse sans-fil
- IT Lucidatrice a batteria
- ES Pulidora a batería
- CN 充电式抛光机

18V Li-Ion | 2100-5000 min⁻¹ | 125 mm | M8 | DUAL ACTION RUCH ORBITALNY | SOFT START MIEKKI START | SPEED REGULATOR REGULACJA PRĘDKOŚCI | BRUSHLESS MOTOR SILNIK BEZ SZCZOTKOWY



$L_{pa} = 75,0 \pm 3,0$ dB; $L_{wa} = 86,0 \pm 3,0$ dB; $a_h = 4,56 \pm 1,5$ m/s²

18V Li-Ion

YATO	[V d.c.]	Battery capacity / Pojemność akumulatora [mAh]	⏱ [h]	Battery quantity / Liczba akumulatorów w zestawie	
YT-82924	18	4000	3	1	6
YT-82925	18	-	-	brak	6

- EN Cordless random orbital sander
- PL Szlifierka oscylacyjna akumulatorowa
- DE Akku-Schwingschleifer
- RU Аккумуляторная шлифовальная машина
- CZ Akumulátorová bruska
- HU Akkumulátoros csiszoló
- RO Șlefuitor cu acumulator
- FR Ponceuse vibrante sans-fil
- IT Levigatrice orbitale a batteria
- ES Lijadora orbital inalámbrica
- CN 充电式砂光机

18V Li-Ion | 0-12000 min⁻¹ | 2.0 mm | ∅ 125 mm



Battery not included
 Ohne Akku / Bez akumulatora
 Bez Gamapeu / Bez aku
 Akkumulátor nélkül
 Fără baterie / Sans batterie
 Senza batteria / Sin batería
 没有电池

Fitting sand papers: see chapter 10
 Pasujące papiery ściernie: patrz rozdział 10

$L_{pa} = 73,7 \pm 3,0$ dB; $L_{wa} = 84,7 \pm 3,0$ dB; $a_h = 7,0 \pm 1,5$ m/s²

YATO	[V d.c.]	
YT-82753	18	4

- EN Cordless orbital sander
- PL Szlifierka oscylacyjna akumulatorowa
- DE Akku-Schwingschleifer
- RU Аккумуляторная шлифовальная машина
- CZ Akumulátorová bruska
- HU Akkumulátoros csiszoló
- RO Șlefuitor cu acumulator
- FR Ponceuse vibrante sans-fil
- IT Levigatrice orbitale a batteria
- ES Lijadora orbital inalámbrica
- CN 充电式砂光机

18V Li-Ion | 13000 min⁻¹ | 2.0 mm | 90x187 mm



Battery not included
 Ohne Akku / Bez akumulatora
 Bez Gamapeu / Bez aku
 Akkumulátor nélkül
 Fără baterie / Sans batterie
 Senza batteria / Sin batería
 没有电池

Fitting sand papers: see chapter 10
 Pasujące papiery ściernie: patrz rozdział 10

$L_{pa} = 77,8 \pm 3,0$ dB; $L_{wa} = 88,8 \pm 3,0$ dB; $a_h = 5,45 \pm 1,5$ m/s²

YATO	[V d.c.]	
YT-82751	18	4

- EN Cordless orbital sander
- PL Szlifierka oscylacyjna akumulatorowa
- DE Akku-Schwingschleifer
- RU Аккумуляторная шлифовальная машина
- CZ Akumulátorová bruska
- HU Akkumulátoros csiszoló
- RO Șlefuitor cu acumulator
- FR Ponceuse vibrante sans-fil
- IT Levigatrice orbitale a batteria
- ES Lijadora orbital inalámbrica
- CN 充电式砂光机

18V Li-Ion | 11000 min⁻¹ | 2.0 mm | 84x184 mm



Battery not included
 Ohne Akku / Bez akumulatora
 Bez Gamapeu / Bez aku
 Akkumulátor nélkül
 Fără baterie / Sans batterie
 Senza batteria / Sin batería
 没有电池

$L_{pa} = 69,6 \pm 3,0$ dB; $L_{wa} = 80,6 \pm 3,0$ dB; $a_h = 7,34 \pm 1,5$ m/s²

YATO	[V d.c.]	
YT-82755	18	4

EN Cordless polisher
PL Polerka akumulatorowa
DE Akku-Polierer
RU Аккумуляторная полировальная машина
CZ Akumulátorová leštička
HU Vezeték nélküli polírozó
RO Aparat de slefuit cu acumulator
FR Polisseuse sans-fil
IT Lucidatrice a batteria
ES Pulidora a batería
CN 充电式抛光机



18V Li-Ion	1500-5000 min ⁻¹	150 mm	M8	DUAL ACTION RUCH ORBITALNY
16 mm	3.0 Ah	1.5h	SOFT START MIĘKKI START	SPEED REGULATOR REGULACJA PRĘDKOŚCI
BRUSHLESS MOTOR SIŁNIK BEZ- SZCZOTKOWY				

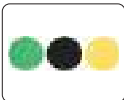

18V
Li-Ion

$L_{pa} = 88,0 \pm 3,0$ dB; $L_{wa} = 99,0 \pm 3,0$ dB; $a_n = 15,540 \pm 1,5 / 18,859 \pm 1,5$ m/s²

YATO	[V d.c.]	
YT-82920	18	4

EN Cordless rotary hammer
PL Akumulatorowa młotowiertarka
DE Akku-Bohrhammer
RU Аккумуляторный перфоратор
CZ Akumulátorové vrtací kladivo
HU Akkus fűrókalapács
RO Ciocan rotopercutor cu acumulator
FR Marteau-perforateur rotatif sans-fil
IT Martello rotativo a batteria
ES Martillo perforador a batería
CN 充电式电锤

18V Li-Ion	SDS PLUS	0-1850 min ⁻¹	T 0-4800 mm ²
2.0J	18 mm	3.0 Ah	1.5h



18V
Li-Ion

$L_{pa} = 95,6 \pm 3,0$; $L_{wa} = 104,0 \pm 3,0$ dB; $a_n = 5,677 \pm 1,5 / 6,334 \pm 1,5$ m/s²

YATO	[V d.c.]	
YT-82770	18	3

EN Cordless polisher
PL Polerka akumulatorowa
DE Akku-Polierer
RU Аккумуляторная полировальная машина
CZ Akumulátorová leštička
HU Vezeték nélküli polírozó
RO Aparat polisat cu acumulator
FR Polisseuse sans-fil
IT Lucidatrice a batteria
ES Pulidora a batería
CN 充电式抛光机

18V Li-Ion	2500 min ⁻¹	254 mm	BRUSHLESS MOTOR SIŁNIK BEZ- SZCZOTKOWY
DUAL ACTION RUCH ORBITALNY	6.0 mm		



18V
Li-Ion

$L_{pa} = 81,0 \pm 3,0$ dB; $L_{wa} = 92,0 \pm 3,0$ dB; $a_n = 7,73 \pm 1,5$ m/s²

YATO	[V d.c.]	
YT-82922	18	4

EN Cordless rotary hammer
PL Akumulatorowa młotowiertarka
DE Akku-Bohrhammer
RU Аккумуляторный перфоратор
CZ Akumulátorové vrtací kladivo
HU Akkus fűrókalapács
RO Ciocan rotopercutor cu acumulator
FR Marteau-perforateur rotatif sans-fil
IT Martello rotativo a batteria
ES Martillo perforador a batería
CN 充电式电锤

18V Li-Ion	SDS PLUS	0-1000 min ⁻¹	T 0-5000 mm ²
2.4J	24 mm		



Battery not included
Ohne Akku / Bez akumulatora
Bez baterije / Bez aku
Akumulator nekil
Fără baterie / Sans batterie
Senza batteria / Sin bateria
没有电池

18V
Li-Ion

$L_{pa} = 89,0 \pm 3,0 / 89,0 \pm 3,0$ dB; $L_{wa} = 100,0 \pm 3,0 / 100,0 \pm 3,0$ dB; $a_n = 13,286 \pm 1,5 / 9,473 \pm 1,5$ m/s²

YATO	[V d.c.]	
YT-82772	18	4

EN Cordless drywall sander
 PL Akumulatorowa szlifierka do gipsu
 DE Akku-Gipsschleifer
 RU Аккумуляторная шлифовальная машина для гипса
 CZ Akumulátorová sádrová bruska
 HU Akkus falcsiszoló
 RO Slefuitor perete cu acumulator
 FR Ponceuse murale sans-fil
 IT Levigatrice per muro a batteria
 ES Lijadora de pared a batería
 CN 充电式无刷打磨机

- Vacuum self suction system integrated
- Adapter diameters: 35, 47 mm
- Included 6 pcs sand paper: P60, P80, P120, P150, P180, P240
- Wbudowany system odśysania pyłu
- Średnice adaptera: 35, 47 mm
- W zestawie 6 szt. papieru ściernego: P60, P80, P120, P150, P180, P240

18V
Li-Ion

18V
Li-Ion

600-1200
min

225
mm

M6

BRUSHLESS
MOTOR
SIŁNIK BEZ
SZCZOTKOWY



Fitting abrasive discs: see chapter 10
 Pasujące krążki ściernie: patrz rozdział 10

$L_{pa} = 87,0 \pm 3,0$ dB; $L_{wa} = 95,0 \pm 3,0$ dB; $q_n = 3,18 \pm 1,5$ m/s²

YATO	[V d.c.]	Battery capacity / Pojemność akumulatora [mAh]	⊕ [h]	Battery quantity / Liczba akumulatorów w zestawie	
YT-82360	18	4000	3	1	2
YT-82361	18	-	-	brak	2

EN Cordless vacuum cleaner
 PL Odkurzacz akumulatorowy
 DE Akku-Staubsauger
 RU Аккумуляторный пылесос
 CZ Akumulátorový vysavač
 HU Akkus szivattyú
 RO Pompa bateriei
 FR Aspirateur sans-fil
 IT Aspirapolvere a batteria
 ES Aspirador a batería
 CN 充电式吸尘器



18V
Li-Ion

3.8
kPa

0.5L

BAGLESS
BEZ
WROTKOWY

Battery not included
 Ohne Akku / Bez akumulatora
 Bez baterije / Bez aku
 Akumulator nélkül
 Fără baterie / Sans batterie
 Senza batteria / Sin baterie
 没有电池

18V
Li-Ion

YATO	[V d.c.]				
YT-85680	18			4	

EN Cordless hybrid air fan
 PL Akumulatorowy wentylator hybrydowy
 DE Akku-Ventilator
 RU Аккумуляторный вентилятор гибридный
 CZ Bateriový ventilátor
 HU Akumulátoros ventilátor
 RO Ventilator cu acumulator
 FR Ventilateur sans-fil
 IT Ventilatore ibrido a batteria
 ES Ventilador a batería
 CN 充电式风扇

18V
Li-Ion

18V
Li-Ion

100-240V~
50/60Hz

HYBRID
HYBRIDOWY

1700
min

2600
min

230
mm

360°



Battery not included
 Ohne Akku / Bez akumulatora
 Bez baterije / Bez aku
 Akumulator nélkül
 Fără baterie / Sans batterie
 Senza batteria / Sin baterie
 没有电池

YATO	[V d.c.]	
YT-82933	18	2

EN Cordless worksite radio
 PL Akumulatorowe radio budowlane
 DE Akku-Baustellenradio
 RU Аккумуляторное строительное радио
 CZ Akumulátorové rádio na stavbu
 HU Akkus építkezési rádió
 RO Radio pt. atelier cu acumulator
 FR Radio d'atelier sans-fil
 IT Radio da officina a batteria
 ES Radio de obra a batería
 CN 蓝牙收音机

18V
Li-Ion

220-240V~
50/60Hz

3W

36h

FM
87.5-108
MHz

AM
522-1710
kHz

x10 FM
x10 AM
PROGRAMMING
PROGRAMOWANIE

LCD
BACKLIGHT
PODSWIETLENIE

USB



Battery not included
 Ohne Akku / Bez akumulatora
 Bez baterije / Bez aku
 Akumulator nélkül
 Fără baterie / Sans batterie
 Senza batteria / Sin baterie
 没有电池

18V
Li-Ion

YATO	[V d.c.]	
YT-82940	18	8

EN Cordless transfer pump for oil and water
 PL Akumulatorowa pompa do oleju i wody
 DE Akku-Pumpe
 RU Аккумуляторный перекачивающий насос
 CZ Akumulátorové čerpadlo
 HU Akkus szivattyú
 RO Pompa bateriei
 FR Pompe à batterie
 IT Pompa a batteria per olio e acqua
 ES Bomba de batería
 CN 无绳水&机油泵

18V
Li-Ion

380
W

3/4"
19mm

1800
l/h

22m

9m

IPX4

FOR WATER
AND OIL
DO WODY
I OLEJU



18V
Li-Ion

YATO	[V d.c.]	Battery capacity / Pojemność akumulatora [mAh]	⊕ [h]	Battery quantity / Liczba akumulatorów w zestawie	
YT-85290	18	3000	1.5	1	2
YT-85291	18	-	-	brak	2

EN Power cutter
PL Przecinarka spalinowa
DE Trennschleifer
RU Бензиновый бензорез
CZ Rozbrušovací pila
HU Beton- és fémdaraboló

RO Motodebitator
FR Découpeuse
IT Troncatrice con motore a combustione interna
ES La cortadora
CN 汽油切割机

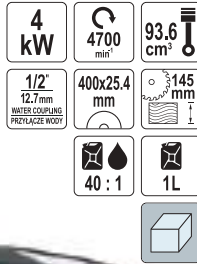

Disc not included
Tarczy nie dołączono

$L_{pa} = 93,35 \pm 2,5 / 107,95 \pm 2,5$ dB; $L_{wa} = 112,33 \pm 2,5 / 115,5 \pm 2,5$ dB;
 $a_n = 6,99 \pm 1,5 / 7,79 \pm 1,5 / 10,26 \pm 1,5 / 9,77 \pm 1,5$ m/s²

YATO	[kW]	
YT-84820	4	1

EN Petrol rotary hammer
PL Spalinowy młot udarowo-obrotowy
DE Benzin Bohr- und Meißelhammer
RU Бензиновый перфоратор
CZ Benzinové kombinované kladivo
HU Benzines forgó bontókalapács
RO Ciocan rotativ cu benzină
FR Marteau rotatif essence
IT Martello combinato perforatore demolitore a benzina
ES Martillo giratorio a gasolina
CN 汽油电锤

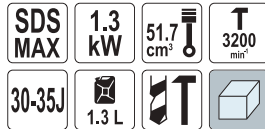

$L_{pa} = 84,0 \pm 3,0$ dB; $L_{wa} = 105,0$ dB; $a_n = 10,76 \pm 1,5 / 18,39 \pm 1,5$ m/s²

YATO	[kW]	[KM]
YT-82138	1.3	1.74

EN Angle grinder
PL Szlifierka kątowa
DE Winkelschleifmaschine
RU Углошлифовальная машина
CZ Úhlová bruska
HU Sarokcsiszoló

RO Polizor unghiular
FR Meuleuse d'angle
IT Smerigliatrice angolare
ES Lijadera de angulo
CN 角磨



$L_{pa} = 87,3 \pm 3,0$ dB; $L_{wa} = 98,3 \pm 3,0$ dB; $a_n = 3,378 \pm 1,5 / 4,746 \pm 1,5$ m/s²

YATO	[W]	
YT-82097	850	6

EN Petrol demolition hammer
PL Spalinowy młot wyburzeniowy
DE Benzin-Abbruchhammer
RU Бензиновый отбойный молоток
CZ Benzinové bourací kladivo
HU Benzines bontókalapács
RO Ciocan demolator cu benzină
FR Marteau piqueur essence
IT Martello demolitore a scoppio
ES Martillo demoleador a gasolina
CN 汽油电镐

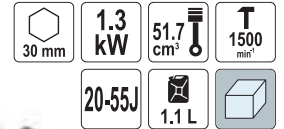

$L_{pa} = 83,0 \pm 3,0$ dB; $L_{wa} = 104,0$ dB; $a_n = 31,87 \pm 1,5 / 31,10 \pm 1,5$ m/s²

YATO	[kW]	[KM]
YT-82007	1.3	1.74

EN Straight grinder
PL Szlifierka prosta
DE Geradschleifer
RU Прямая шлифмашина
CZ Příčná bruska
HU Egyenes csiszoló

RO Polizor drept
FR Meuleuse droite
IT Smerigliatrice diritta
ES Amoladora recta
CN 直磨机



$L_{pa} = 75,0 \pm 3,0$ dB; $L_{wa} = 85,0 \pm 3,0$ dB; $a_n = 2,5 \pm 1,5$ m/s²

YATO	[W]	
YT-82080	750	8

EN Angle grinder
PL Szlifierka kątowa
DE Winkelschleifmaschine
RU Углошлифовальная машина
CZ Úhlová bruska
HU Sarokcsiszoló

RO Polizor unghiular
FR Meuleuse d'angle
IT Smerigliatrice angolare
ES Lijadera de angulo
CN 角磨



$L_{pa} = 79,0 \pm 3,0$ dB; $L_{wa} = 90,0 \pm 3,0$ dB; $a_n = 3,98 \pm 1,5$ m/s²

YATO	[W]	
YT-82100	1100	6

EN Angle grinder
 PL Szlifierka kątowa
 DE Winkelschleifmaschine
 RU Углошлифовальная машина
 CZ Úhlová bruska
 HU Sarokcsiszoló

RO Polizor unghiular
 FR Meuleuse d'angle
 IT Smerigliatrice angolare
 ES Lijadera de angulo
 CN 角磨



230-240V-50Hz	1100 W	3000-2000 min ⁻¹
125 mm	M14	SPEED REGULATOR REGULĂTORIA VITEI (FREKVENCII)
SOFT START MIEKKI START	3 m	



Fitting discs: see chapter 10
 Pasujące tarcze: patrz rozdział 10

$L_{pa} = 87,3 \pm 3,0$ dB; $L_{wa} = 95,3 \pm 3,0$ dB; $a_h = 6,743 \pm 1,5$ m/s²

YATO	[W]	
YT-82101	1100	8

EN Angle grinder
 PL Szlifierka kątowa
 DE Winkelschleifmaschine
 RU Углошлифовальная машина
 CZ Úhlová bruska
 HU Sarokcsiszoló

RO Polizor unghiular
 FR Meuleuse d'angle
 IT Smerigliatrice angolare
 ES Lijadera de angulo
 CN 角磨

230-240V-50Hz	1400 W	3000-2000 min ⁻¹
125 mm	M14	3 m
SOFT START MIEKKI START		



$L_{pa} = 89,3 \pm 3,0$ dB; $L_{wa} = 100,3 \pm 3,0$ dB; $a_h = 6,95 \pm 1,5$ m/s²

YATO	[W]	
YT-82099	1400	6

EN Angle grinder
 PL Szlifierka kątowa
 DE Winkelschleifmaschine
 RU Углошлифовальная машина
 CZ Úhlová bruska
 HU Sarokcsiszoló
 RO Polizor unghiular
 FR Meuleuse d'angle
 IT Smerigliatrice angolare
 ES Lijadera de angulo
 CN 角磨



230-240V-50Hz	1700 W	2850-10500 min ⁻¹	125 mm
M14	3 m		



$L_{pa} = 97,0 \pm 3,0$ dB; $L_{wa} = 105,0 \pm 3,0$ dB; $a_h = 4,5 \pm 1,5 / 6,0 \pm 1,5 / 2,8 \pm 1,5$ m/s²

YATO	[W]	
YT-821024	1700	6

EN Angle grinder
 PL Szlifierka kątowa
 DE Winkelschleifmaschine
 RU Углошлифовальная машина
 CZ Úhlová bruska
 HU Sarokcsiszoló

RO Polizor unghiular
 FR Meuleuse d'angle
 IT Smerigliatrice angolare
 ES Lijadera de angulo
 CN 角磨

230-240V-50Hz	1400 W	3000-2000 min ⁻¹
125 mm	M14	3 m



$L_{pa} = 89,3 \pm 3,0$ dB; $L_{wa} = 100,3 \pm 3,0$ dB; $a_h = 6,95 \pm 1,5$ m/s²

YATO	[W]	
YT-82098	1400	6

EN Angle grinder
 PL Szlifierka kątowa
 DE Winkelschleifmaschine
 RU Углошлифовальная машина
 CZ Úhlová bruska
 HU Sarokcsiszoló
 RO Polizor unghiular
 FR Meuleuse d'angle
 IT Smerigliatrice angolare
 ES Lijadera de angulo
 CN 角磨

230-240V-50Hz	1700 W	10500 min ⁻¹	125 mm
M14	SOFT START MIEKKI START	3 m	



$L_{pa} = 97,0 \pm 3,0$ dB; $L_{wa} = 105,0 \pm 3,0$ dB; $a_h = 4,5 \pm 1,5 / 6,0 \pm 1,5 / 2,8 \pm 1,5$ m/s²

YATO	[W]	
YT-821023	1700	6

EN Angle grinder
 PL Szlifierka kątowa
 DE Winkelschleifmaschine
 RU Углошлифовальная машина
 CZ Úhlová bruska
 HU Sarokcsiszoló

RO Polizor unghiular
 FR Meuleuse d'angle
 IT Smerigliatrice angolare
 ES Lijadera de angulo
 CN 角磨

220-240V-50Hz	2000 W	8500 min ⁻¹	125 mm
180 mm	M14	3 m	



$L_{pa} = 92,5 \pm 3,0$ dB; $L_{wa} = 103,5 \pm 3,0$ dB; $a_h = 7,03 \pm 1,5$ m/s²

YATO	[W]	
YT-82104	2000	4

EN Angle grinder
PL Szlifierka kątowa
DE Winkelschleifmaschine
RU Углошлифовальная машина
CZ Úhlová bruska
HU Sarokcsiszoló

RO Polizor unghiular
FR Meuleuse d'angle
IT Smerigliatrice angolare
ES Lijadera de ángulo
CN 角磨

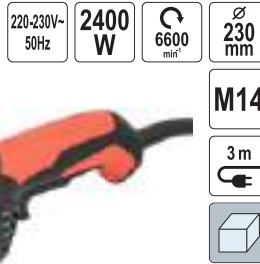

$L_{pa} = 91,9 \pm 3,0$ dB; $L_{ma} = 102,9 \pm 3,0$ dB; $a_p = 7,448 \pm 1,5 / 5,2 \pm 1,5$ m/s²

YATO	[W]	[Cube icon]
YT-82105	2400	2

EN Angle grinder
PL Szlifierka kątowa
DE Winkelschleifmaschine
RU Углошлифовальная машина
CZ Úhlová bruska
HU Sarokcsiszoló

RO Polizor unghiular
FR Meuleuse d'angle
IT Smerigliatrice angolare
ES Lijadera de ángulo
CN 角磨

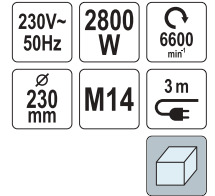

$L_{pa} = 91,8 \pm 3,0$ dB; $L_{ma} = 102,8 \pm 3,0$ dB; $a_p = 4,478 \pm 1,5 / 4,956 \pm 1,5$ m/s²

YATO	[W]	[Cube icon]
YT-82110	2800	2

EN Drill stand
PL Statyw do wiertarki
DE Bohrmaschinen-Ständer
RU Стойка для дрели
CZ Stativ do vrtačky
HU Fúróállvány
RO Suport masina de gaurit
FR Support de forage
IT Supporto per trapano
ES Soporte para taladro
CN 电钻支架



YATO	H [mm]	[Cube icon]
YT-82970	500	3

EN Drill stand
PL Statyw do wiertarki
DE Bohrmaschinen-Ständer
RU Стойка для дрели
CZ Stativ do vrtačky
HU Fúróállvány
RO Suport masina de gaurit
FR Support de forage
IT Supporto per trapano
ES Soporte para taladro
CN 电钻支架



YATO	H [mm]	[Cube icon]
YT-82971	400	6

EN Angle grinder stand
PL Statyw do szlifierki kątowej
DE Winkelschleif-Trennständer
RU Стойка для угловой шлифовальной машины
CZ Stojan pro úhlovou brusku
HU Állvány sarokcsiszolóhoz
RO Suport pt. polizor unghiular
FR Support pour meuleuse d'angle
IT Supporto per smerigliatrice angolare
ES Soporte para lijadora de ángulo
CN 角磨支架



YATO	[Cube icon]
YT-82972	4

EN Universal guide rail with clamps
PL Prowadnica uniwersalna ze ściskami
DE Universal-Führungsschiene mit Zwingen
RU Шина направляющая универсальная с зажимами
CZ Univerzální vodící lišta se svorkami
HU Univerzális vezetősin szorítóelemekkel
RO Sina de ghidare universală cu cleme
FR Rail de guidage universel avec pinces
IT Guida universale con morsetti
ES Carril de guía universal con pinzas
CN 电圆锯用导轨组套



YATO	L [mm]	[Cube icon]
YT-36990	1500	5

EN Dust extractor
 PL Osłona przeciwpylowa
 DE Staubabsaugung
 RU Системные принадлежности
 CZ Odsavač prachu
 HU Tapadó porszívó adapter
 RO Sistem de aspirare a prafului
 FR Le dispositif d'aspiration pour de perçage
 IT Adattatore aspirazione polvere
 ES Sistema de aspiración de polvo
 CN 吸尘座



max Ø
16 mm

Ø
26-39 mm



EN Dust extractor
 PL Osłona przeciwpylowa
 DE Staubabsaugung
 RU Системные принадлежности
 CZ Odsavač prachu
 HU Tapadó porszívó adapter
 RO Sistem de aspirare a prafului
 FR Le dispositif d'aspiration pour de perçage
 IT Adattatore aspirazione polvere
 ES Sistema de aspiración de polvo
 CN 吸尘座



max Ø **70 mm**

Ø **26-39 mm**



For YT-6045, YT-60374, YT-43979
 Dla YT-6045, YT-60374, YT-43979

YATO 

YT-82980  40

YATO 

YT-82982  30

EN Dust extractor
 PL Osłona przeciwpylowa
 DE Staubabsaugung
 RU Системные принадлежности
 CZ Odsavač prachu
 HU Tapadó porszívó adapter
 RO Sistem de aspirare a prafului
 FR Le dispositif d'aspiration pour de perçage
 IT Adattatore aspirazione polvere
 ES Sistema de aspiración de polvo
 CN 吸尘座

max Ø **90 mm**

Ø **26-39 mm**



For YT-6046, YT-60375, YT-43981
 Dla YT-6046, YT-60375, YT-43981

YATO 

YT-82984  18

EN Dust extractor
 PL Osłona przeciwpylowa
 DE Staubabsaugung
 RU Системные принадлежности
 CZ Odsavač prachu
 HU Tapadó porszívó adapter
 RO Sistem de aspirare a prafului
 FR Le dispositif d'aspiration pour de perçage
 IT Cuffia aspirazione polvere
 ES Sistema de aspiración de polvo
 CN 吸尘座

Ø **125 mm**

Ø **28-36 mm**

Ø **32 mm**

M14



For YT-82098, YT-82099, YT-60470
 Dla YT-82098, YT-82099

YATO 

YT-82986  12

EN Dust extractor
 PL Osłona przeciwpylowa
 DE Staubabsaugung
 RU Системные принадлежности
 CZ Odsavač prachu
 HU Tapadó porszívó adapter
 RO Sistem de aspirare a prafului
 FR Le dispositif d'aspiration pour de perçage
 IT Cuffia aspirazione polvere
 ES Sistema de aspiración de polvo
 CN 吸尘座

Ø **230 mm**

Ø **28-36 mm**

max Ø **28 mm**

5-30 mm

M14



For YT-82098, YT-82099, YT-56961
 Dla YT-82098, YT-82099, YT-56961

YATO 

YT-82988  10

EN Dust extractor
 PL Osłona przeciwpylowa
 DE Staubabsaugung
 RU Системные принадлежности
 CZ Odsavač prachu
 HU Tapadó porszívó adapter
 RO Sistem de aspirare a prafului
 FR Le dispositif d'aspiration pour de perçage
 IT Cuffia aspirazione polvere
 ES Sistema de aspiración de polvo
 CN 吸尘座

Ø **230 mm**

Ø **50-65 mm**

max Ø **60 mm**

M14



For YT-82110, YT-59965
 Dla YT-82110, YT-59965

YATO 

YT-82990  4

EN Dust extractor
 PL Osłona przeciwpylowa
 DE Staubabsaugung
 RU Системные принадлежности
 CZ Odsavač prachu
 HU Tapadó porszívó adapter
 RO Sistem de aspirare a prafului
 FR Le dispositif d'aspiration pour de perçage
 IT Cuffia aspirazione polvere
 ES Sistema de aspiración de polvo
 CN 吸尘座

max Ø **125 mm**

Ø **28-36 mm**

max Ø **32 mm**

M14



For YT-82094, YT-82097, YT-82100, YT-82101
 Dla YT-82094, YT-82097, YT-82100, YT-82101

YATO 

YT-82992  20

EN Dust extractor
 PL Osłona przeciwpylowa
 DE Staubabsaugung
 RU Системные принадлежности
 CZ Odsavač prachu
 HU Tapadó porszívó adapter
 RO Sistem de aspirare a prafului
 FR Le dispositif d'aspiration pour de perçage
 IT Cuffia aspirazione polvere
 ES Sistema de aspiración de polvo
 CN 吸尘座

CONCRETE BETON

WOOD DREWNO

Ø **125 mm**

Ø **28-36 mm**

Ø **115 mm**

M14



For YT-82098, YT-82101, YT-60470
 Fitting blades: YT-60322, YT-83265
 Dla YT-82098, YT-82101
 Pasujące tarcze: YT-60322, YT-83265

YATO 

YT-82994  30

- EN Slider for grinding tiles
PL Przystawka do szlifowania płytek pod kątem
DE Kantenschleifaufsatz für handgeführte Gehrungsschnitte
RU Насадка для резки плитки под углом
CZ Nástavec na broušení dlaždic pod úhlem
HU Sarokcsiszoló tartozék gérvágásokhoz
RO Ghidaj pt. tesirea plăcii ceramice
FR Accessoire pour meuleuse d'angle pour coupes d'onglet
IT Adattatore per smussatura di piastrelle
ES Adaptador para cortar azulejos en ángulo
CN 切割支架



YATO		
YT-82985		10

- EN Electric nibbler
PL Nożyce elektryczne do blachy
DE Elektrische Blechscherer
RU Листовые ножницы по металлу
CZ Elektrický prostřihovač plechu
HU Elektromos lemezvágó olló
RO Foarfeca electrica pt. taiat tabla
FR Cisaille électrique pour tôle
IT Cesoia elettrica per lamiera
ES Punzonadora eléctrica para chapa
CN 电冲剪

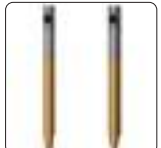

TWO BLADES IN SET
DWA OSTRZA W KOMPLEKIE

$L_{pa} = 88,0 \pm 3,0$; $L_{wa} = 99,0 \pm 3,0$; $a_h = 11,57 \pm 1,5 \text{ m/s}^2$

YATO	[W]	
YT-82395	600	5

- EN Spare nibbler blade
PL Ostrze do nożyc elektrycznych
DE Ersatzmesser für elektrische Blechscherer
RU Запасное лезвие для электрических ножниц
CZ Razník do prostřihovače plechu
HU Tartalék penge ollóhoz
RO Lama rezerva pt. foarfeca electrica tabla
FR Lame pour cisailles électriques
IT Lama di ricambio per cesoia elettrica
ES Cuchilla para punzonadora eléctrica
CN 冲针

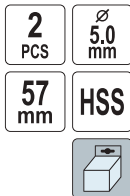

For YT-82395
Dla YT-82395

YATO	Ø [mm]	
YT-82396	5	500

- EN Wall chaser
PL Bruzdownica
DE Mauernutfräse
RU Штроборез стеновой
CZ Drážkovací fréza do zdiva
HU Falhoronymarógép
RO Circular manual pt. piatra
FR Rainreuse à béton
IT Scanalatrice
ES Máquina de ranurado de pared
CN 开槽机

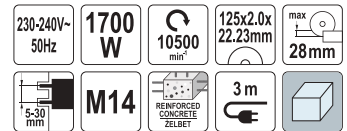

For YT-59962
Dla YT-59962

$L_{pa} = 93,0 \pm 3,0 \text{ dB}$; $L_{wa} = 105,0 \pm 3,0 \text{ dB}$; $a_h = 2,8 \pm 1,5 \text{ m/s}^2$

YATO	[W]	
YT-82015	1700	4

- EN Concrete cutter
PL Przecinarka do betonu
DE Betonschneider
RU Электрическая отрезная машина по бетону
CZ Rezačka betonu
HU Betonvágó
RO Drujbă de beton
FR Decoupeuse beton
IT Troncatrice per cemento
ES Cortador de hormigón
CN 混凝土切割机

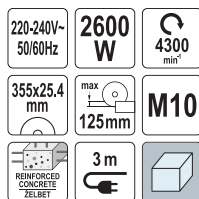

$L_{pa} = 99,0 \pm 3,0 \text{ dB}$; $L_{wa} = 110,0 \pm 3,0 \text{ dB}$; $a_h = 8,22 \pm 1,5 \text{ m/s}^2$

YATO	[W]	
YT-82158	2600	1

- EN Wet stone polisher
PL Polerka do kamienia na mokro
DE Nass-Steinpolierer
RU Воздушно-мокрый полировщик для камня
CZ Leštička na kámen za mokra
HU Vizes köcsiszoló
RO Slefuitor umed piatra
FR Polisseuse à pierre humide
IT Lucidatrice per pietra a umido
ES Pulidora para piedra en mojado
CN 水磨机

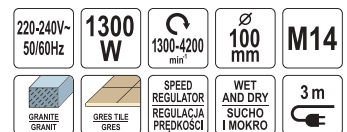

$L_{pa} = 85,0 \pm 3,0 \text{ dB}$; $L_{wa} = 93,0 \pm 3,0 \text{ dB}$; $a_h = 5,58 \pm 1,5 \text{ m/s}^2$

YATO	[W]	
YT-82161	1300	6

EN Electric tile cutter
 PL Przecinarka do glazury
 DE Fliesenscheider
 RU Плиткорез электрический
 CZ Elektrická pila na dlažbu
 HU Elektromos csempévo gép
 RO Aparat electric pt. taiat faianta
 FR Scie carrelage
 IT Tagliapiastrelle
 ES Cortadora de gres
 CN 云石机

220-230V-50Hz
1400 W
 12000 min⁻¹
 125 mm
 125x22.2 x1.6 mm
 WET AND DRY SUCHO I MOKRO
 3 m
 CIRCUIT BREAKER WYŁĄCZNIK ROZKŁADOWY



$L_{pa} = 102,6 \pm 3,0$ dB; $L_{wa} = 113,6 \pm 3,0$ dB; $a_h = 5,753 \pm 1,5$ m/s²

YATO	[W]	
YT-82159	1400	4

EN Car polisher
 PL Polerka samochodowa
 DE Autopoliermaschine
 RU Полировальная машина
 CZ Leštíčka na automobily
 HU Gépkocsi polírozógép
 RO Masina de lustruit automobile
 FR Polisseur de voiture
 IT Levigatrice per auto
 ES Maquina para pulir coches
 CN 偏心抛光机



220-240V-50Hz
720 W
 2100-5000 min⁻¹
 150 mm
 M8
 5 m



$L_{pa} = 85,0 \pm 3,0$ dB; $L_{wa} = 96,0 \pm 3,0$ dB; $a_h = 5,56 \pm 1,5$ m/s²

YATO	[W]	
YT-82200	720	4

EN Car polisher
 PL Przecinarka ściernicowa do metalu
 DE Autopoliermaschine
 RU Полировальная машина
 CZ Leštíčka na automobily
 HU Gépkocsi polírozógép
 RO Masina de lustruit automobile
 FR Polisseur de voiture
 IT Levigatrice per auto
 ES Maquina para pulir coches
 CN 磨光器



220-240V-50Hz
1400 W
 600-3500 min⁻¹
 180 mm
 M14
 5 m



$L_{pa} = 89,5 \pm 3,0$ dB; $L_{wa} = 100,5 \pm 3,0$ dB; $a_h = 1,489 \pm 1,5 / 1,785 \pm 1,5$ m/s²

YATO	[W]	
YT-82196	1400	2

EN Grinding wheel cutter for metal
 PL Przecinarka ściernicowa do metalu
 DE Trennschleifer für Metall
 RU Абразивно-отрезной станок по металлу
 CZ Rozbrušovací pila na kovy
 HU Gyorsdaraboló fémhez
 RO Ferăstrău abraziv pt. metal
 FR Scie a métaux
 IT Trapano a percussione
 ES Cortador abrasivo para metales
 CN 型材切割机



200°C



$L_{pa} = 95,8 \pm 3,0$ dB; $L_{wa} = 108,8 \pm 3,0$ dB

YATO	[W]	
YT-82181	2450	1

EN Band saw
 PL Pila taśmowa
 DE Bandsäge
 RU Ленточная пила
 CZ Pásová pila
 HU Szalagfűrész
 RO Fierăstrău cu banda
 FR Scie à ruban
 IT Sega a nastro
 ES Sierra de cinta
 CN 带锯

220-240V-50Hz
1100 W
 0,7-2,4 m/s
 14 TPI
 1140x12,7 x0,6 mm
 127 mm
 3 m



$L_{pa} = 89,0 \pm 3,0$ dB; $L_{wa} = 100,0 \pm 3,0$ dB; $a_h = 6,62 \pm 1,5 / 6,08 \pm 1,5$ m/s²

YATO	[W]	
YT-82185	1100	1

EN Impact drill
 PL Wiertarka udarowa
 DE Schlagbohrmaschine
 RU Ударная дрель
 CZ Příkladová vrtačka
 HU Útvérő

RO Bormașină cu percucie
 FR Perceuse à percussion
 IT Trapano a percussione
 ES Taladro de percusión
 CN 冲击钻

220-240V-50Hz
710 W
 0-2800 min⁻¹
 0-44800 min⁻¹
 25 mm
 13 mm
 13 mm
 3 m



$L_{pa} = 80,0 \pm 3,0$ dB; $L_{wa} = 91,0 \pm 3,0$ dB; $a_h = 2,95 \pm 1,5 / 8,46 \pm 1,5$ m/s²

YATO	[W]	
YT-82034	710	5

EN Impact drill
PL Wiertarka udarowa
DE Schlagbohrmaschine
RU Ударная дрель
CZ Přiklepová vrtačka
HU Ütvefűró

RO Bormașină cu percúție
FR Perceuse à percussion
IT Trapano a percussione
ES Taladro de percusión
CN 冲击钻

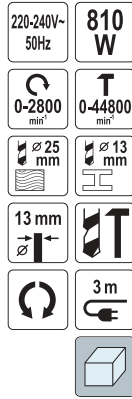

$L_{PA} = 87,0 \pm 3,0$ dB; $L_{WA} = 98,0 \pm 3,0$ dB; $a_h = 2,29 \pm 1,5 / 8,5 \pm 1,5$ m/s²

YATO	[W]	5
YT-82036	810	

EN Impact drill
PL Wiertarka udarowa
DE Schlagbohrmaschine
RU Ударная дрель
CZ Přiklepová vrtačka
HU Ütvefűró

RO Bormașină cu percúție
FR Perceuse à percussion
IT Trapano a percussione
ES Taladro de percusión
CN 冲击钻



$L_{PA} = 89,0 \pm 3,0$ dB; $L_{WA} = 100,0 \pm 3,0$ dB; $a_h = 2,39 \pm 1,5 / 8,78 \pm 1,5$ m/s²

YATO	[W]	5
YT-82037	850	

EN Impact drill
PL Wiertarka udarowa
DE Schlagbohrmaschine
RU Ударная дрель
CZ Přiklepová vrtačka
HU Ütvefűró

RO Bormașină cu percúție
FR Perceuse à percussion
IT Trapano a percussione
ES Taladro de percusión
CN 冲击钻

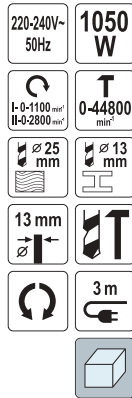

$L_{PA} = 97,0 \pm 3,0$ dB; $L_{WA} = 108,0 \pm 3,0$ dB; $a_h = 2,85 \pm 1,5 / 10,1 \pm 1,5$ m/s²

YATO	[W]	5
YT-82044	1050	

EN Impact drill
PL Wiertarka udarowa
DE Schlagbohrmaschine
RU Ударная дрель
CZ Přiklepová vrtačka
HU Ütvefűró

RO Bormașină cu percúție
FR Perceuse à percussion
IT Trapano a percussione
ES Taladro de percusión
CN 冲击钻

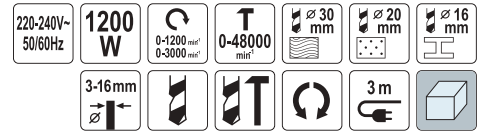

$L_{PA} = 82,0 \pm 5,0$ dB; $L_{WA} = 93,0 \pm 5,0$ dB; $a_h = 12,2 \pm 1,5 / 2,2 \pm 1,5$ m/s²

YATO	[W]	5
YT-82045	1200	

EN Electric drill/driver
PL Wiertarko-wkrętarzka sieciowa
DE Netz-Bohrschrauber
RU Сетевая дрель-шуруповерт
CZ Elektrický vrtací šroubovák
HU Hálózati fűró-csavarozó

RO Mașină de găurit și înșurubat (bormasina) electrică
FR Foret électrique
IT Trapano avvitatore elettrico
ES Taladro atornillador eléctrico
CN 扭力钻



$L_{PA} = 83,1 \pm 3,0$ dB; $L_{WA} = 94,1 \pm 3,0$ dB; $a_h = 3,32 \pm 1,5$ m/s²

YATO	[W]	6
YT-82060	300	

EN Electric drill/driver
PL Wiertarko-wkrętarzka sieciowa
DE Netz-Bohrschrauber
RU Сетевая дрель-шуруповерт
CZ Elektrický vrtací šroubovák
HU Hálózati fűró-csavarozó

RO Mașină de găurit și înșurubat (bormasina) electrică
FR Foret électrique
IT Trapano avvitatore elettrico
ES Taladro atornillador eléctrico
CN 扭力钻

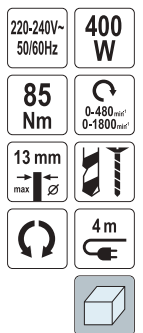

$L_{PA} = 88,0 \pm 5,0$ dB; $L_{WA} = 99,0 \pm 5,0$ dB; $a_h = 6,57 \pm 1,5$ m/s²

YATO	[W]	8
YT-82063	400	

EN Drywall screwdriver
PL Wkrętarka elektryczna
DE Trockenbauschrauber
RU Сетевой шуруповёрт
CZ Sádrotkartonářský šroubovák
HU Gipszkarton csavarzó

RO Şurubelniţă pt. gips-carton
FR Visseuse spécial plaquiste
IT Avvitatore elettrico
ES Atornilladores para construcción en seco
CN 墙板螺丝刀

230-240V~50Hz

550 W

0-5500 min⁻¹

1/4" 6.3 mm

25-55 x3.5 mm

3 m



$L_{pa} = 81,9 \pm 3,0$ dB; $L_{wa} = 92,9 \pm 3,0$ dB; $a_n = 0,53 \pm 1,5$ m/s²

YATO	[W]	
YT-82071	550	5

EN Diamond drill
PL Wiertnica diamentowa
DE Diamantbohrmaschine
RU Дрель алмазного сверления
CZ Diamantová vrtačka
HU Gyémántfűrőgép
RO Maşină de găurit cu diamant
FR Appareil de forage diamant
IT Perforatrice diamantata
ES Taladradora de diamante
CN 水钻

RO Şurubelniţă pt. gips-carton
FR Visseuse spécial plaquiste
IT Avvitatore elettrico
ES Atornilladores para construcción en seco
CN 墙板螺丝刀

230V~50Hz

2800 W

700 min⁻¹

∅ 300 mm

1 1/4" 32 mm

1/4" 6.3 mm WATER COUPLING PREPLACED WOOD

REINFORCED CONCRETE ZELBET



Fitting core drill bits: see chapter 10
Fitting water tank: YT-86211

Pasujące wiertła koronowe: patrz rozdział 10
Pasująca hydronetka: YT-86211

$L_{pa} = 92,4 \pm 3,0$ dB; $L_{wa} = 105,4 \pm 3,0$ dB

YATO	[W]	
YT-81983	2800	1

EN Rotary hammer
PL Młotowiertarka
DE Bohrhammer
RU Перфоратор
CZ Vrtací kladivo
HU Fűrőkalapács

RO Ciocan rotopercutor
FR Marteau perforateur
IT Martello rotativo
ES Martillo perforador
CN 电锤

230V~50Hz

SDS PLUS

1100 W

850 min⁻¹

T 5000 min⁻¹

5.0 J

∅ 32 mm

3 m

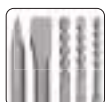
$L_{pa} = 95,0 \pm 3,0$ dB; $L_{wa} = 106,0 \pm 3,0$ dB; $a_n = 14,65 \pm 1,5 / 12,77 \pm 1,5$ m/s²

YATO	[W]	
YT-82123	1100	2

EN Diamond drill
PL Wiertnica diamentowa
DE Diamantbohrmaschine
RU Дрель алмазного сверления
CZ Diamantová vrtačka
HU Gyémántfűrőgép

RO Maşină de găurit cu diamant
FR Appareil de forage diamant
IT Perforatrice diamantata
ES Taladradora de diamante
CN 水钻

230V~50Hz

2200 W

1200 min⁻¹

∅ 180 mm

1 1/4" 32 mm

1/4" 6.3 mm WATER COUPLING PREPLACED WOOD

REINFORCED CONCRETE ZELBET



Fitting core drill bits: see chapter 10
Fitting water tank: YT-86211

Pasujące wiertła koronowe: patrz rozdział 10
Pasująca hydronetka: YT-86211

$L_{pa} = 90,0 \pm 3,0$ dB; $L_{wa} = 103,0 \pm 3,0$ dB; $a_n = 2,90 \pm 1,5$ m/s²

YATO	[W]	
YT-81980	2200	1

EN Rotary hammer
PL Młotowiertarka
DE Bohrhammer
RU Перфоратор
CZ Vrtací kladivo
HU Fűrőkalapács

RO Ciocan rotopercutor
FR Marteau perforateur
IT Martello rotativo
ES Martillo perforador
CN 电锤

220-240V~50Hz

SDS PLUS

850 W

0-1300 min⁻¹

T 0-5100 min⁻¹

3.3 J

∅ 30 mm

∅ 32 mm

∅ 13 mm

3 m



$L_{pa} = 92,3 \pm 3,0$ dB; $L_{wa} = 103,3 \pm 3,0$ dB; $a_n = 11,964 \pm 1,5 / 10,037 \pm 1,5$ m/s²

YATO	[W]	
YT-82122	850	3

EN Rotary hammer
PL Młotowiertarka
DE Bohrhammer
RU Перфоратор
CZ Vrtací kladivo
HU Fűrőkalapács

RO Ciocan rotopercutor
FR Marteau perforateur
IT Martello rotativo
ES Martillo perforador
CN 电锤

220-240V~50Hz

SDS PLUS

1100 W

0-900 min⁻¹

T 4300 min⁻¹

4.5 J

∅ 28 mm

SPEED REGULATOR REGULACIJA PREDKOSCI

3 m



$L_{pa} = 95,0 \pm 3,0$ dB; $L_{wa} = 109,0 \pm 3,0$; $a_n = 15,91 \pm 1,5 / 12,97 \pm 1,5$ m/s²

YATO	[W]	
YT-82118	1100	2

EN Rotary hammer
PL Młotowiertarka
DE Bohrhammer
RU Перфоратор
CZ Vrtací kladivo
HU Fúrókalapács

RO Ciocan rotopercutor
FR Marteau perforateur
IT Martello rotativo
ES Martillo perforador
CN 电锤



230V~50Hz
SDS PLUS
1500 W
800 min⁻¹
3900 min⁻¹
5.0 J
∅ 32 mm
2 m

$L_{pa} = 94,6 \pm 3,0$ dB; $L_{wa} = 105,6 \pm 3,0$ dB; $a_h = 19,167 \pm 1,5 / 13,314 \pm 1,5$ m/s²

YATO	[W]	
YT-82127	1500	2

EN Rotary hammer
PL Młotowiertarka
DE Bohrhammer
RU Перфоратор
CZ Vrtací kladivo
HU Fúrókalapács

RO Ciocan rotopercutor
FR Marteau perforateur
IT Martello rotativo
ES Martillo perforador
CN 电锤

230V~50Hz
SDS MAX
1600 W
175-350 min⁻¹
1150-2350 min⁻¹
25 J
∅ 52 mm



$L_{pa} = 96,1 \pm 3,0$ dB; $L_{wa} = 107,1 \pm 3,0$ dB; $a_h = 22,31 \pm 1,5 / 20,91 \pm 1,5$ m/s²

YATO	[W]	
YT-82135	1600	1

EN Demolition hammer
PL Młot wyburzeniowy
DE Abbruchhammer
RU Отбойный молоток
CZ Bourací kladivo
HU Bontókalapács
RO Ciocan demolator
FR Brise-béton
IT Martello demolitore
ES Martillo de demolición
CN 电镐

230V~50Hz
1600 W
1900 min⁻¹
65 J
OIL COOLING
CHŁODZENIE OLEJEM
x2
3 m



• Switch lock for continuous operation
• Blokada włącznika do pracy ciągłej

$L_{pa} = 94,0 \pm 3,0$ dB; $L_{wa} = 105,0 \pm 3,0$ dB; $a_h = 14,59 \pm 1,5$ m/s²

YATO	[W]	
YT-82001	1600	1

EN Rotary hammer
PL Młotowiertarka
DE Bohrhammer
RU Перфоратор
CZ Vrtací kladivo
HU Fúrókalapács

RO Ciocan rotopercutor
FR Marteau perforateur
IT Martello rotativo
ES Martillo perforador
CN 电锤



220-240V~50Hz
SDS MAX
1300 W
300-540 min⁻¹
2900 min⁻¹
20 J
∅ 150 mm
∅ 50 mm



$L_{pa} = 95,0 \pm 3,0$ dB; $L_{wa} = 106,0 \pm 3,0$ dB; $a_h = 20,93 \pm 1,5 / 23,19 \pm 1,5$ m/s²

YATO	[W]	
YT-82131	1300	2

EN Chiselling hammer
PL Młot dłutujący
DE Schlaghammer
RU Отбойный молоток
CZ Sekací kladivo
HU Vésőkalapács
RO Ciocan demolator
FR Marteau-piqueur
IT Martello demolitore
ES Martillo de percusión
CN 电镐

220-240V~50Hz
SDS MAX
1150 W
4850 min⁻¹
15 J
4,8 kg
2,5 m



$L_{pa} = 83,5 \pm 3,0$ dB; $L_{wa} = 97,5 \pm 2,4$ dB; $a_h = 15,546 \pm 1,5$ m/s²

YATO	[W]	
YT-82133	1150	2

EN Demolition hammer
PL Młot wyburzeniowy
DE Abbruchhammer
RU Отбойный молоток
CZ Bourací kladivo
HU Bontókalapács
RO Ciocan demolator
FR Brise-béton
IT Martello demolitore
ES Martillo demoledor
CN 电镐

230V~50Hz
1600 W
1900 min⁻¹
70 J
OIL COOLING
CHŁODZENIE OLEJEM
x2



• Switch lock for continuous operation
• Blokada włącznika do pracy ciągłej

$L_{pa} = 91,3 \pm 3,0$ dB; $L_{wa} = 100,4 \pm 2,42$ dB; $a_h = 14,59 \pm 1,5$ m/s²

YATO	[W]	
YT-82002	1600	1

- EN Concrete vibrator (motor and poker shaft)
- PL Wibrator do betonu (napęd i buława)
- DE Betonrüttler (Antrieb und Rüttelflasche)
- RU Глубинный вибратор для бетона (вал + наконечник)
- CZ Ponočný vibrátor (pohon i hadice)
- HU Betonvibrátor (meghajtás és tömlő)
- RO Vibrator beton (motor si lance)
- FR Vibreur à béton (moteur et arbre à tôle)
- IT Vibratore per calcestruzzo (motore e sonda)
- ES Vibrador de hormigón (motor y cabezal)
- CN 混凝土振动器

230V~50Hz 1200 W 5000 min⁻¹

∅ 35 mm 3.5 m



$L_{pA} = <70 \text{ dB}$; $L_{wA} = <85 \text{ dB}$; $a_h = <2,5 \text{ m/s}^2$

YATO	[W]	
YT-82600	1200	1

- EN Cordless concrete vibrator (motor and poker shaft)
- PL Akumulatorowy wibrator do betonu (napęd i buława)
- DE Akku-Betonrüttler (Antrieb und Rüttelflasche)
- RU Аккумуляторный глубинный вибратор для бетона (вал + наконечник)
- CZ Akumulátorový ponočný vibrátor (pohon i hadice)
- HU Akkumulátoros betonvibrátor (meghajtás és tömlő)
- RO Vibrator beton cu acumulator (motor si lance)
- FR Vibreur à béton sans-fil (moteur et arbre à tôle)
- IT Vibratore per calcestruzzo a batteria (motore e sonda)
- ES Vibrador de hormigón a batería (motor y cabezal)
- CN 充电式混凝土振动器

18 V 3100 min⁻¹ 12500 min⁻¹

1.2 m ∅ 25 mm



Battery not included
 Ohne Akku / Bez akumulatora
 Без аккумулятора / Bez aku
 Akkumulátor nélkül
 Fără baterie / Sans batterie
 Senza batteria / Sin batería
 没有电池

$L_{pA} = 63,0 \pm 3,0 \text{ dB}$; $L_{wA} = 74,0 \pm 3,0 \text{ dB}$; $a_h = 3,2 \pm 1,5 \text{ m/s}^2$

YATO	[V d.c.]	
YT-82604	18	4

- EN Concrete vibrator (motor and poker shaft)
- PL Wibrator do betonu (napęd i buława)
- DE Betonrüttler (Antrieb und Rüttelflasche)
- RU Глубинный вибратор для бетона (вал + наконечник)
- CZ Ponočný vibrátor (pohon i hadice)
- HU Betonvibrátor (meghajtás és tömlő)
- RO Vibrator beton (motor si lance)
- FR Vibreur à béton (moteur et arbre à tôle)
- IT Vibratore per calcestruzzo (motore e sonda)
- ES Vibrador de hormigón (motor y cabezal)
- CN 混凝土振动器

230V~50Hz 2300 W

4000 min⁻¹ ∅ 35 mm

4 m



$L_{pA} = <70 \text{ dB}$; $L_{wA} = <85 \text{ dB}$; $a_h = <2,5 \text{ m/s}^2$

YATO	[W]	
YT-82601	2300	1

- EN Poker shaft
- PL Wąż do wibrowania betonu
- DE Rüttelflasche
- RU Вал гибкий для вибратора бетона
- CZ Hadice k ponočnému vibrátoru
- HU Betonvibrátor tömlő
- RO Lance pt. vibrator beton
- FR Tuyau de vibration pour béton
- IT Testa per vibratore per calcestruzzo
- ES Cabezal de vibrador de hormigón
- CN 振动棒

∅ 35 mm 3 m



For YT-82600
 Dla YT-82600

YATO	L [m]	
YT-82595	3	1

- EN Poker shaft
- PL Wąż do wibrowania betonu
- DE Rüttelflasche
- RU Вал гибкий для вибратора бетона
- CZ Hadice k ponočnému vibrátoru
- HU Betonvibrátor tömlő
- RO Lance pt. vibrator beton
- FR Tuyau de vibration pour béton
- IT Testa per vibratore per calcestruzzo
- ES Cabezal de vibrador de hormigón
- CN 振动棒

∅ 35 mm 4 m



For YT-82601
 Dla YT-82601

YATO	L [m]	
YT-82596	4	1

- EN Poker shaft
- PL Wąż do wibrowania betonu
- DE Rüttelflasche
- RU Вал гибкий для вибратора бетона
- CZ Hadice k ponočnému vibrátoru
- HU Betonvibrátor tömlő
- RO Lance pt. vibrator beton
- FR Tuyau de vibration pour béton
- IT Testa per vibratore per calcestruzzo
- ES Cabezal de vibrador de hormigón
- CN 振动棒

∅ 25 mm 1.2 m



For YT-82604
 Dla YT-82604

YATO	L [m]	
YT-82597	1.2	4

EN Electric paddle mixer
PL Mieszarka do zapraw
DE Mörtelmischgerät
RU Электрическая мешалка для минометов
CZ Míchadlo na maltu
HU Habarcskeverő
RO Malaxor pt. mortar
FR Mélangeur a mortier
IT Trapano miscelatore
ES Mezcladora de mortero
CN 手持式搅拌机

220-240V~50/60Hz **1600 W** 180-480^{max} / 300-750^{min} 160 mm 140L **M14**



$L_{pa} = 87,0 \pm 3,0$ dB; $L_{wa} = 98,0 \pm 3,0$ dB; $a_n = 5,23 \pm 1,5$ m/s²

YATO	[W]	
YT-82607	1600	2

EN Plunge saw
PL Zagłębiarka
DE Tauchsäge
RU Погружная пила
CZ Ponorná pila
HU Merülőfűrészhez
RO Ferăstrău circular
FR Scie plongeante
IT Sega circolare a tuffo
ES Sierra circular de incisión
CN 轨道锯

220-230V~50Hz **1300 W**

2000-5000 min⁻¹ 165x20 x2.4 mm

90°/55mm
45°/38mm
CUTTING DEPTH
GLEBKOSCIĘCENIA



$L_{pa} = 89,0 \pm 3,0$ dB; $L_{wa} = 100,0 \pm 3,0$ dB; $a_n = 1,4 \pm 1,5$ m/s²

YATO	[W]	
YT-82168	1300	2

EN Guide rail for plunge saw
PL Prowadnica do zagłębiarki
DE Führungsschiene für Tauchsäge
RU Направляющая шина для погружной пилы
CZ Vodičí lišta pro ponornou pílu
HU Vezetősín merülőfűrészhez

RO Sina de ghidare pt. ferăstrău circular
FR Rail de guidage pour scie plongeante
IT Guida per seghe circolari
ES Carril de guía para sierra de incisión
CN 导轨

1400 mm **AI**

POSSIBILITY OF COMBINATION
MOŻLIWOŚĆ ŁĄCZENIA



For YT-82168
Dla YT-82168

YATO	L [mm]	
YT-82169	1400	5

EN Circular saw
PL Pilarka elektryczna
DE Handkreissäge
RU Дисковая пила
CZ Ručna kružna pila
HU Kézi körfűrész
RO Fierăstrău circular de mana
FR Scie circulaire
IT Sega circolare
ES Sierra circular
CN 台锯

220-240V~50Hz **1500 W** 4800 185x20 x2.8 mm **24T**

65 mm 90°-65 mm 45°-45 mm 3 m



Fitting blades: see chapter 10
Pasujące tarcze: patrz rozdział 10

$L_{pa} = 95,1 \pm 3,0$ dB; $L_{wa} = 106,1 \pm 3,0$ dB; $a_n = 2,86 \pm 1,5$ m/s²

YATO	[W]	
YT-82152	1500	2

EN Electric paddle mixer
PL Mieszarka do zapraw
DE Mörtelmischgerät
RU Электрическая мешалка для минометов
CZ Míchadlo na maltu
HU Habarcskeverő
RO Malaxor pt. mortar
FR Mélangeur a mortier
IT Trapano miscelatore
ES Mezcladora de mortero
CN 低速钻

220-230V~50/60Hz **1200 W**

0-1000 min⁻¹ max 130 mm

3-16 mm 40 mm

16 mm

3 m



• Screwdriving: max T40 x 400 mm

• Wkręcanie: maks. T40 x 400 mm

$L_{pa} = 71,63 \pm 3,0$ dB; $L_{wa} = 82,63 \pm 3,0$ dB; $a_n = 3,148 \pm 1,5$ m/s²

YATO	[W]	
YT-82055	1200	4

EN Circular saw
PL Pilarka elektryczna
DE Handkreissäge
RU Дисковая пила
CZ Ručna kružna pila
HU Kézi körfűrész
RO Ferăstrău circular de mana
FR Tronçonneuse
IT Sega circolare
ES Sierra circular
CN 电圆锯

220-240V~50Hz **1500 W** 5500 185x20 x2.8 mm

24T 63 mm 90°-63 mm 45°-44 mm

3 m



Fitting blades: see chapter 10
Pasujące tarcze: patrz rozdział 10

$L_{pa} = 95,0 \pm 3,0$ dB; $L_{wa} = 106,0 \pm 3,0$ dB; $a_n = 3,526 \pm 1,5 / 2,905 \pm 1,5$ m/s²

YATO	[W]	
YT-82151	1500	2

EN Circular saw
PL Pilarka elektryczna
DE Handkreissäge
RU Дисковая пила
CZ Ručna kružna pila
HU Kézi körfűrész
RO Fierăstrău circular de mana
FR Scie circulaire
IT Sega circolare
ES Sierra circular
CN 台锯

220-240V~50Hz **2800 W** 4800 235x25.4 x3.0 mm **24T**

85 mm 90°-85 mm 45°-60 mm HIGH CUTTING RANGE DUBY ZAKRES CIĘCIA

3 m



Fitting blades: see chapter 10
Pasujące tarcze: patrz rozdział 10

$L_{pa} = 99,0 \pm 3,0$ dB; $L_{wa} = 110,0 \pm 3,0$ dB; $a_n = 1,847 \pm 1,5$ m/s²

YATO	[W]	
YT-82154	2800	2

EN Cordless miter saw
 PL Ukośnica akumulatorowa
 DE Akku-Paneelsäge
 RU Аккумуляторная торцовочная пила
 CZ Akumulátorová pokosová píla se základzem
 HU Akkus sines gérvágó
 RO Ferăstrău circular staționar cu acumulator
 FR Scie à onglet sans-fil
 IT Sega angolare a batteria
 ES Ingletadora telescópica a batería
 CN 充电式斜切锯

18 V Li-Ion	3600 min ⁻¹	185x30 x1.8 mm	40T
90°/51mm CUTTING DEPTH OLEBNOSČ CIEKA	90°/203mm CUTTING LENGTH DLUŽOSČ CIEKA	II CLASS / KLASA	



18V
Li-Ion!

Fitting blades: see chapter 10
 Pasujące tarcze: patrz rozdział 10

L_{pa} = 83,14 ± 3,0 dB; L_{wa} = 96,14 ± 3,0 dB

YATO [V d.c.]	Battery capacity / Pojemność akumulatora [mAh]	⚡ [h]	Battery quantity / Liczba akumulatorów w zestawie	
YT-82816	18 4000	2	1	1
YT-82817	18 -	-	brak	1

EN Miter saw
 PL Ukośnica
 DE Paneelsäge
 RU Панельная пила
 CZ Pokosová píla se základzem
 HU Sines gérvágó
 RO Ferăstrău circular staționar
 FR Scie à onglet radiale
 IT Sega angolare taglio leghe
 ES Ingletadora telescópica
 CN 斜切锯

220-240V~ 50Hz	1800 W	255x25.4 x1.4 mm	36T
 METAL	2500 min ⁻¹	90°/5mm CUTTING DEPTH OLEBNOSČ CIEKA	90°/305mm CUTTING LENGTH DLUŽOSČ CIEKA
 WOOD DREWNO	3800 min ⁻¹	90°/70mm CUTTING DEPTH OLEBNOSČ CIEKA	90°/305mm CUTTING LENGTH DLUŽOSČ CIEKA
II CLASS / KLASA	3 m		



Fitting blades: see chapter 10
 Pasujące tarcze: patrz rozdział 10

L_{pa} = 93,0 ± 3,0 dB; L_{wa} = 105,0 ± 3,0 dB

YATO [W]	
YT-82174 1800	1

EN Miter saw
 PL Ukośnica
 DE Paneelsäge
 RU Панельная пила
 CZ Pokosová píla se základzem
 HU Sines gérvágó
 RO Ferăstrău circular staționar
 FR Scie à onglet radiale
 IT Sega angolare taglio leghe
 ES Ingletadora telescópica
 CN 斜切锯

220-240V~ 50Hz	1500 W	4500 min ⁻¹	185x20 x2.8 mm
24T	90°/210mm CUTTING DEPTH OLEBNOSČ CIEKA	90°/60mm CUTTING LENGTH DLUŽOSČ CIEKA	II CLASS / KLASA
3 m			



Fitting blades: see chapter 10
 Pasujące tarcze: patrz rozdział 10

L_{pa} = 93,6 ± 3,0 dB; L_{wa} = 106,6 ± 3,0 dB

YATO [W]	
YT-82172 1500	1

EN Miter saw
 PL Ukośnica
 DE Paneelsäge
 RU Панельная пила
 CZ Pokosová píla se základzem
 HU Sines gérvágó

RO Ferăstrău circular staționar
 FR Scie à onglet radiale
 IT Sega angolare taglio leghe
 ES Ingletadora telescópica
 CN 斜切锯

220-240V~ 50Hz	1800 W	5000 min ⁻¹	255x30 x2.8 mm
24T	90°/70mm CUTTING DEPTH OLEBNOSČ CIEKA	90°/305mm CUTTING LENGTH DLUŽOSČ CIEKA	II CLASS / KLASA
3 m			



Fitting blades: see chapter 10
 Pasujące tarcze: patrz rozdział 10

L_{pa} = 94,3 ± 3,0 dB; L_{wa} = 107,3 ± 3,0 dB

YATO [W]	
YT-82173 1800	1

EN Miter saw
PL Ukośnica
DE Paneelsäge
RU Панельная пила
CZ Pokosová pila se zákluzem
HU Sínes gérvágó

RO Ferăstrău circular staționar
FR Scie à onglet radiale
IT Sega angolare taglio leghe
ES Ingletadora telescópica
CN 斜切锯



Fitting blades: see chapter 10
Pasujące tarcze: patrz rozdział 10

$L_{pa} = 90,7 \pm 3,0$ dB; $L_{wa} = 103,7 \pm 3,0$ dB

YATO	[W]	
YT-82175	1800	1

EN Jig saw
PL Wyrzynarka
DE Stichsäge
RU Электрический лобзик
CZ Přímočará pila
HU Szűrőfűrész
RO Ferăstrău pt. traforaj
FR Scie sauteuse
IT Seghetto alternativo
ES Sierra de calar
CN 曲线锯

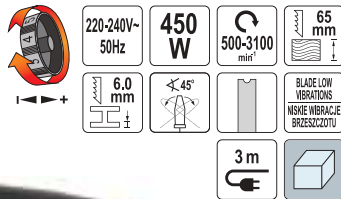

$L_{pa} = 86,0 \pm 3,0$ dB; $L_{wa} = 97,0 \pm 3,0$ dB; $a_h = 8,27 \pm 1,5 / 10,65 \pm 1,5$ m/s²

YATO	[W]	
YT-82274	450	8

EN Electric table saw
PL Piłarka stołowa do drewna
DE Tischkreissäge für Holz
RU Настольной пила для древесины
CZ Stolní pila do dřeva
HU Asztali körfűrész fűző
RO Ferestrău circular pt. lemn
FR Scie sur table
IT Sega circolare da banco
ES Máquina cortadora para madera
CN 台锯



Fitting blades: see chapter 10
Pasujące tarcze: patrz rozdział 10

$L_{pa} = 91,0 \pm 3,0$ dB; $L_{wa} = 104,0 \pm 3,0$ dB

YATO	[W]	
YT-82165	1800	1

EN Jig saw
PL Wyrzynarka
DE Stichsäge
RU Электрический лобзик
CZ Přímočará pila
HU Szűrőfűrész
RO Ferăstrău pt. traforaj
FR Scie sauteuse
IT Seghetto alternativo
ES Sierra de calar
CN 曲线锯

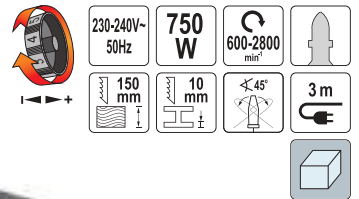

$L_{pa} = 89,0 \pm 3,0$ dB; $L_{wa} = 100,0 \pm 3,0$ dB; $a_h = 8,87 \pm 1,5 / 5,51 \pm 1,5$ m/s²

YATO	[W]	
YT-82267	750	4

EN Cordless planer
 PL Strug akumulatorowy
 DE Akku-Hobel
 RU Аккумуляторный рубанок
 CZ Akumulátorový hoblík
 HU Akkus gyalu
 RO Rindea electrica cu acumulator
 FR Robot sans-fil
 IT Piaalla a batteria
 ES Garlopa a batería
 CN 锂电电刨

18V
Li-Ion

15000
min⁻¹

0-2
mm

82 mm

BRUSHLESS
MOTOR
SIŁNIK BEZ
SZCZOTKOWY



Battery not included
 Ohne Akku / Bez akumulatora
 Bez ładowarki / Bez aku
 Akumulator nečludí
 Fără baterie / Sans batterie
 Senza batteria / Sin batería
 没有电池

18V
Li-Ion

$L_{pa} = 84,0 \pm 3,0$ dB; $L_{wa} = 95,0 \pm 3,0$ dB; $a_n = 5,22 \pm 1,5$ m/s²

YATO	[V d.c.]	
YT-82192	18	6

EN Electric planer
 PL Strug elektryczny
 DE Elektrohobel
 RU Электрорубанок
 CZ Elektrický hoblík
 HU Elektromos gyalu

230V~
50Hz

810
W

16500
min⁻¹

0-3
mm

max 11 mm

82 mm

3 m



$L_{pa} = 87,0 \pm 3,0$ dB; $L_{wa} = 98,0 \pm 3,0$ dB; $a_n = 7,68 \pm 1,5$ m/s²

YATO	[W]	
YT-82141	810	6

EN Electric planer
 PL Strug elektryczny
 DE Elektrohobel
 RU Электрорубанок
 CZ Elektrický hoblík
 HU Elektro

RO Rindea electrica
 FR Robot
 IT Piaalla elettrica
 ES Garlopa electrica
 CN 电刨

230-240V~
50Hz

1300
W

16000
min⁻¹

0-3,5
mm

110mm

3 m



$L_{pa} = 84,0 \pm 3,0$ dB; $L_{wa} = 95,0 \pm 3,0$ dB; $a_n = 7,11 \pm 1,5$ m/s²

YATO	[W]	
YT-82144	1300	2

EN Cordless router
 PL Akumulatorowa frezarka górnoprzecionowa
 DE Akku-Oberfräse
 RU Аккумуляторная фрезерная машина
 CZ Akumulátorová horní frézka
 HU Akkus felsőmaró
 RO Mașină de frezat cu acumulator
 FR Défonceuse sans-fil
 IT Fresatrice verticale a batteria
 ES Fresadora de superficie a batería
 CN 电木铣

3 in 1
3 w 1

18V
Li-Ion

8000-26000
min⁻¹

6, 8 mm

max 55 mm

SOFT
START
MIEKKI
START

BRUSHLESS
MOTOR
SIŁNIK BEZ
SZCZOTKOWY



18V
Li-Ion

Battery not included
 Ohne Akku / Bez akumulatora
 Bez ładowarki / Bez aku
 Akumulator nečludí
 Fără baterie / Sans batterie
 Senza batteria / Sin batería
 没有电池

- Planer
- Straight grinder
- Edge trimmer
- Frezarka
- Szliferka prosta
- Frezarka krawędziowa

$L_{pa} = 78,0 \pm 3,0$ dB; $L_{wa} = 89,0 \pm 3,0$ dB; $a_n = 2,47 \pm 1,5$ m/s²

YATO	[V d.c.]	
YT-82194	18	6

EN Router
 PL Frezarka górnoprzecionowa
 DE Oberfräse
 RU Вертикальная фрезерная машина
 CZ Horní frézka
 HU Felsőmaró
 RO Mașină de frezat
 FR Défonceuse
 IT Fresatrice verticale
 ES Fresadora de superficie
 CN 电木铣

220-240V~
50Hz

710
W

13000-33000
min⁻¹

6, 8 mm

SOFT
START
MIEKKI
START



$L_{pa} = 92,0 \pm 3,0$ dB; $L_{wa} = 102,0 \pm 3,0$ dB; $a_n = 2,388 \pm 1,5$ m/s²

YATO	[W]	
YT-82390	710	4

EN Router
 PL Frezarka górnoprzecionowa
 DE Oberfräse
 RU Вертикальная фрезерная машина
 CZ Horní frézka
 HU Felsőmaró

RO Mașină de frezat
 FR Défonceuse
 IT Fresatrice verticale
 ES Fresadora de superficie
 CN 电木铣

220-240V~
50Hz

2100
W

8,12 mm

8000-23500
min⁻¹

max 55 mm

3 m



Fitting router bits: see chapter 10
 Pasujące frezy: patrz rozdział 10

$L_{pa} = 94,0 \pm 3,0$ dB; $L_{wa} = 105,0 \pm 3,0$ dB; $a_n = 3,41 \pm 1,5$ m/s²

YATO	[W]	
YT-82380	2100	2

EN Belt sander
PL Szlifierka taśmowa
DE Bandschleifer
RU Ленточная шлифмашина
CZ Pásová bruska
HU Szalagsziszológép

RO Sac rumegus
FR Ponceuse à bande
IT Levigatrice a nastro
ES Máquina de pulir de banda
CN 砂带机

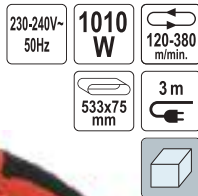

Fitting abrasive bands: see chapter 10
Pasujące paski ściernic: patrz rozdział 10

$L_{pa} = 90,0 \pm 3,0$ dB; $L_{wa} = 101,0 \pm 3,0$ dB; $a_n = 5,1 \pm 1,5$ m/s²

YATO	[W]	
YT-82240	1010	4

EN Orbital sander
PL Szlifierka mimośrodowa
DE Exzentrische Schleifmaschine
RU Экцентриковая шлифовальная машина
CZ Excentrická bruska
HU Excenter csiszoló
RO Polizor cu excentric
FR Ponceuse orbitale
IT Smerigliatrice eccentrica
ES Pulidor excentrico
CN 砂光机

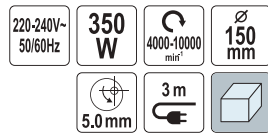

$L_{pa} = 80,0 \pm 3,0$ dB; $L_{wa} = 91,0 \pm 3,0$ dB; $a_n = 3,7 \pm 1,5$ m/s²

YATO	[W]	
YT-82206	350	6

EN Finishing sander
PL Szlifierka oscylacyjna
DE Schwingschleifer
RU Виброшлифмашина
CZ Oscilační bruska
HU Vibrációs csiszológép

RO Polizor oscilant
FR Ponceuse vibrante
IT Levigatrici orbitali
ES Lijadora de oscilación
CN 打磨机



$L_{pa} = 82,0 \pm 3,0$ dB; $L_{wa} = 93,0 \pm 3,0$ dB; $a_n = 5,4 \pm 1,5$ m/s²

YATO	[W]	
YT-82230	260	4

EN Sabre saw
PL Piła szablasta
DE Säbelsäge
RU Сабельная пила
CZ Pila ocaska
HU Szablyafűrész

RO Ferăstrău electric
FR Scie sabre
IT Sega a gattuccio
ES Sierra de sable
CN 往复锯

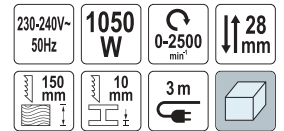

$L_{pa} = 92,2 \pm 3,0$ dB; $L_{wa} = 103,2 \pm 3,0$ dB; $a_n = 25,65 \pm 1,5$ m/s²

YATO	[W]	
YT-82281	1050	4

EN Orbital sander
PL Szlifierka mimośrodowa
DE Exzentrische Schleifmaschine
RU Экцентриковая шлифовальная машина
CZ Excentrická bruska
HU Excenter csiszoló
RO Polizor cu excentric
FR Ponceuse orbitale
IT Smerigliatrice eccentrica
ES Pulidor excentrico
CN 砂光机



$L_{pa} = 82,0 \pm 3,0$ dB; $L_{wa} = 90,0 \pm 3,0$ dB; $a_n = 12,5 \pm 1,5$ m/s²

YATO	[W]	
YT-82207	450	6

EN Burnishing machine
PL Satyniarka
DE Satiniermaschine
RU Универсальная барабанная шлифмашина
CZ Saténovací bruska
HU Palástsciszoló
RO Mașină de lustruit
FR Ponceuse à tambour
IT Satinatrice
ES Satinadora
CN 拉丝抛光机



• Included wheel drums: nylon and steel wire
• W zestawie szczotki: nylonowa i drucziana

$L_{pa} = 88,0 \pm 3,0$ dB; $L_{wa} = 99,0 \pm 3,0$ dB; $a_n = 8,85 \pm 1,5$ m/s²



YATO	[W]	
YT-81953	1300	2

EN Wheel drum for burnishing machine
 PL Szczotka do satyniarki
 DE Rundbürste für Satiniermaschine
 RU Щетка для барабанной шлифмашины
 CZ Válec do saténovací brusky
 HU Palástcsiszoló kefe
 RO Butuc pt. masina de lustruit
 FR Brosse pour ponceuse à tambour
 IT Spazzola per satinatrice
 ES Rodillo abrasivo para satinadora
 CN 拉丝轮



• For removing paint coatings from wooden surfaces, e.g. creased patio boards
 • Do usuwania powłok malarskich z powierzchni drewnianych, np. desek tarasowych ryflowanych

For YT-81953
 Dla YT-81953

YATO 	
YT-81954	20

EN Wheel drum for burnishing machine
 PL Szczotka do satyniarki
 DE Rundbürste für Satiniermaschine
 RU Щетка для барабанной шлифмашины
 CZ Válec do saténovací brusky
 HU Palástcsiszoló kefe
 RO Butuc pt. masina de lustruit
 FR Brosse pour ponceuse à tambour
 IT Spazzola per satinatrice
 ES Rodillo abrasivo para satinadora
 CN 拉丝轮



• For removing rust and paint
 • Do usuwania rdzy i powłok malarskich

For YT-81953
 Dla YT-81953

YATO 	
YT-81955	20

EN Drywall sander
 PL Szlifierka do tynków
 DE Wandschleifer
 RU Шлифмашина
 CZ Brůska muriva
 HU Kézi csiszoló fal

RO De perete manual slefuitor
 FR Ponceuse a platre filaire
 IT Levigatrice per intonaco
 ES Lijadora virutex pared manual
 CN 多功能打磨机

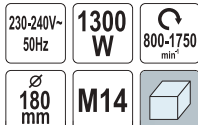

Fitting sand papers: see chapter 10
 Pasujące papiery ściernie: patrz rozdział 10

$L_{pa} = 97,0 \pm 3,0$ dB; $L_{max} = 108,0 \pm 3,0$ dB; $a_n = 8,96 \pm 1,5 / 13,04 \pm 1,5$ m/s²



• Concrete grinding
 • Plaster sanding
 • Szlifowanie betonu
 • Szlifowanie gipsu

YATO 	[W]	
YT-82341	1300	2

EN Drywall sander
 PL Szlifierka do tynków
 DE Wandschleifer
 RU Шлифмашина
 CZ Brůska muriva
 HU Kézi csiszoló fal

RO De perete manual slefuitor
 FR Ponceuse a platre filaire
 IT Levigatrice per intonaco
 ES Lijadora virutex pared manual
 CN 干墙打磨机



• Vacuum self suction system integrated
 • Wbudowany system odsysania pyłu
 Fitting sand papers: see chapter 10
 Pasujące papiery ściernie: patrz rozdział 10



$L_{pa} = 85,0 \pm 3,0$ dB; $L_{max} = 96,0 \pm 3,0$ dB; $a_n = 4,83 \pm 1,5$ m/s²

YATO 	[W]	
YT-82340	1220	2

EN Plaster smoothing and rendering machine
 PL Zacieraczka do tynków gipsowych i cementowych
 DE Putzglättmaschine für Gips- und Zementputz
 RU Машина для затирки штукатурки
 CZ Hladíčka na sádrové a cementové omítky
 HU Vakolalsimító gép
 RO Masina de netezire tencuiei
 FR Truelle électrique pour enduit de plâtre et de ciment
 IT Frattazzatrice per intonaci a base di gesso e intonaci cementizi
 ES Lijadora de yeso y hormigón
 CN 旋转电动抹子



$L_{pa} = 88,6 \pm 3,0$ dB; $L_{max} = 99,6 \pm 3,0$ dB; $a_n = 1,528 \pm 1,5$ m/s²

YATO 	[W]	
YT-82330	750	2

EN Drywall sander
PL Szlifierka na wysięgniku do ścian
DE Wandschleifmaschine mit Ausleger
RU Шлифовальная машина для стен
CZ Bruska na stěny s ramenem
HU Hosszúszerű falcsiszoló
RO Polizor cu brat pt. pereti
FR Ponceuse pour cloison sèche
IT Levigatrice telescopica per muri
ES Pulidor para paredes en un brazo
CN 干墙打磨机



- Vacuum self suction system integrated
- Wbudowany system odsysania pyłu



Fitting sand papers: see chapter 10
Pasujące papiery ściernie: patrz rozdział 10

$L_{pa} = 88,0 \pm 3,0$ dB; $L_{wa} = 99,0 \pm 3,0$ dB; $a_h = 3,48 \pm 1,5 / 3,51 \pm 1,5$ m/s²

YATO	[W]	
YT-82350	710	2

EN Drywall sander
PL Szlifierka na wysięgniku do ścian
DE Wandschleifmaschine mit Ausleger
RU Шлифовальная машина для стен
CZ Bruska na stěny s ramenem
HU Hosszúszerű falcsiszoló
RO Polizor cu brat pt. pereti
FR Ponceuse pour cloison sèche
IT Levigatrice telescopica per muri
ES Pulidor para paredes en un brazo
CN 干墙打磨机



- Vacuum self suction system integrated
- Wbudowany system odsysania pyłu



Fitting abrasive discs: see chapter 10
Pasujące krążki ściernie: patrz rozdział 10

$L_{pa} = 86,0 \pm 3,0$ dB; $L_{wa} = 97,0 \pm 3,0$ dB; $a_h = 7,91 \pm 1,5$ m/s²

YATO	[W]	
YT-82355	820	2

EN Extension pole for plaster smoothing machine
PL Przedłużka do zacieraczki
DE Teleskopstange für Putzglättmaschine
RU Телескопический удлинитель для затирочной машины
CZ Tyč prodlužovací pro hladičku na omítky
HU Vakolatsítmító hosszabbító
RO Prelungitor pt. mașina de netezit tencuieli
FR Extension pour truelle électrique
IT Prolunga per frattazzatrice
ES Extensión para lijadora
CN 延长杆

80-150
cm

TELESCOPIC
HANDLE
USCIVIT
TELESCOPOVY

ALUMINIUM
HIGH QUALITY
PROFILE
ALUMINIUM
PROFIL WYSOKEJ
JAKOŚCI



For YT-82330
Dla YT-82330

YATO	L [mm]	
YT-82332	800-1500	10

EN Disc for smoothing render and cement floors
PL Dysk do zacierania tynków cementowych i posadzek
DE Kellenscheibe für Zementputz und Fußbodenkellen
RU Диск для затирочной машины
CZ Kotouč pro stěrkování cementových omítek a podlah
HU Cementvakolat és aljzalsítmító tárcsa
RO Disc pt. netezirea tencuielilor și a pardoselilor de ciment
FR Plaque de truelle rotative pour enduits de ciment et sols
IT Disco frattazzatrice per intonaci cementizi e pavimentazioni
ES Disco de lija para cemento y suelos
CN 铁盘

375
mm

STEEL
STAL



For YT-82330
Dla YT-82330

YATO	Ø [mm]	
YT-82333	375	8

EN Sand paper for plaster smoothing machine
PL Papier ścierny do zacieraczki
DE Schleifpapier für Putzglättmaschine
RU Наждачная бумага для затирочной машины
CZ Brusný papír pro hladičku na omítky
HU Csiszolópapír vakolatsítmítóhoz
RO Hârtie abrazivă pt. mașina de netezire a tencuielii
FR Papier abrasif pour truelle électrique
IT Carta vetrata per frattazzatrice
ES Papel abrasivo para lijadora
CN 砂纸

5
PCS

P24

400
mm

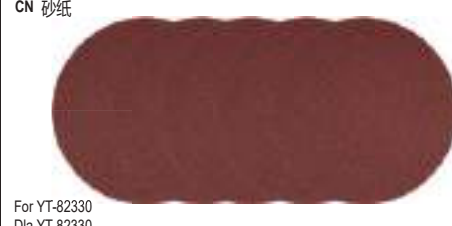

For YT-82330
Dla YT-82330

YATO	Grit / Ziarnistość	Ø [mm]	
YT-82334	P24	400	20

EN Disc for smoothing sand and cement render
PL Dysk do zacierania tynków cementowo-wapiennych
DE Kelle zum Glätten von Zement-Kalk-Putz
RU Диск для затирочной машины
CZ Kotouč pro stěrkování cemento-vápenných omítek
HU Mész-cement vakolatsítmító tárcsa
RO Disc pt. netezirea tencuielii de nisip și ciment
FR Plaque de truelle rotative pour enduit chaux-ciment
IT Disco frattazzatrice per intonaci calce-cemento
ES Disco de lija para cemento y cal
CN 塑料盘

375
mm

PVC



For YT-82330
Dla YT-82330

YATO	Ø [mm]	
YT-82335	375	20

EN Hook and loop fastener disc for sponge and sand paper
PL Dysk z rzepem do gąbki i papieru ściernego
DE Kletttscheibe für Schwamm und Schleifpapier
RU Диск на липучке для губки и наждачной бумаги
CZ Kotouč se suchým zipem pro houby a brusný papír
HU Tépőzáras rögzítőtárcsa szivacsos és csiszolópapírhoz
RO Disc de fixare pt. burete și șmirghel
FR Disque velcro pour éponge et papier de verre
IT Disco con velcro per spugna e carta vetrata
ES Disco con velcro para esponja y papel abrasivo
CN 底盘

375
mm

PVC



For YT-82330
Dla YT-82330

YATO	Ø [mm]	
YT-82336	375	15

EN Sponge disc for rendering gypsum walls
PL Dysk gąbkowy do zacierania tynków gipsowych
DE Schwammsscheibe zum Glätten von Gipsputz
RU Диск губчатый для затирочной машины
CZ Hubkový kotouč pro stěrkování sádrových omítek
HU Szivacos tárcsa gipszvakolat simításhoz
RO Disc burete pt. finisarea pereților din gips
FR Disque éponge pour enduits de gypse
IT Disco spugna frattazzatrice per intonaci a base di gesso
ES Disco de esponja para yeso
CN 清洁海绵盘

390
mm



For YT-82330
Dla YT-82330

YATO	Ø [mm]	
YT-82337	390	56

EN Electric spray gun
 PL Elektryczny pistolet malarski
 DE Elektro Farbspritzpistole
 RU Электрический пульверизатор
 CZ Elektrická pistole malířská
 HU Elektromos festékszoro pisztolyé
 RO Pistol de vopsit - electric
 FR Pistolet à peinture électrique
 IT Pistola elettrica per verniciare
 ES Pistola de pintar electric
 CN 电动喷枪



230V~50Hz **500 W**
 1.8 mm **0.4 l/min**
 1000 ml

$L_{pa} = 102,0 \pm 3,0$ dB; $L_{wa} = 113,0 \pm 3,0$ dB; $a_n = 2,12 \pm 1,5$ m/s²

YATO	[W]	
YT-82550	500	4

EN Airless paint sprayer
 PL Agregat malarski
 DE Farbsprüngerät
 RU Краскопульты
 CZ Stříkací zařízení
 HU Festékszóró rendszer
 RO Pompa vopsit airless
 FR Pistolet à peinture
 IT Unità di verniciatura
 ES Bomba de piston para spray de pintura airless
 CN 高压无气喷涂机



230V~50Hz **480 W**
 22.7 MPa AIRLESS BEZ-POWETRZNY
 15 m

• For wall paints
 • Do farb ściennych

$L_{pa} = 73,9 \pm 3,0$ dB; $L_{wa} = 81,0 \pm 3,0$ dB; $a_n = \leq 2,5$ m/s²

YATO	[W]	
YT-82562	480	1

EN HVLP paint sprayer
 PL Agregat malarski HVLP
 DE HVLP-Aggregat für Farbspritzen
 RU Краскопульт HVLP для распыления краски
 CZ Malířský postřikovač HVLP
 HU Festékszóró rendszer HVLP
 RO Pompa vopsit HVLP
 FR Agrégat de peinture par pulvérisation HVLP
 IT Unità di verniciatura HVLP
 ES Bomba de piston para spray de pintura HVLP
 CN 拉杆式喷枪



220-230V~50/60Hz **1380 W**
 800 ml **HVLP**
 5 m TELESCOPIC HANDLE UCHWYT TELESKOPOWY
 EASY CLEAN ŁATWE CZYSZCZENIE 3 m

• For wall paints
 • Do farb ściennych

$L_{pa} = 85,2 \pm 3,0$ dB; $L_{wa} = 96,2 \pm 3,0$ dB; $a_n = < 1,5$ m/s²

YATO	[W]	
YT-82555	1380	2

EN Electric spray gun
 PL Elektryczny pistolet malarski
 DE Elektro Farbspritzpistole
 RU Электрический пульверизатор
 CZ Elektrická pistole malířská
 HU Elektromos festékszoro pisztolyé
 RO Pistol electric de vopsit
 FR Pistolet a peinture électrique
 IT Pistola elettrica per verniciare
 ES Pistola de pintar electric
 CN 电动喷枪



220-240V~50Hz **600 W**
 2.6 mm **1.0 l/min**
 1000 ml

$L_{pa} = 80,4 \pm 3,0$ dB; $L_{wa} = 91,4 \pm 3,0$ dB; $a_n = 0,67 \pm 1,5$ m/s²

YATO	[W]	
YT-82553	600	6

EN Airless paint sprayer
 PL Agregat malarski
 DE Farbsprüngerät
 RU Краскопульты
 CZ Stříkací zařízení
 HU Festékszóró rendszer

RO Pompa vopsit airless
 FR Pistolet à peinture
 IT Unità di verniciatura
 ES Bomba de piston para spray de pintura airless
 CN 高压无气喷涂机



220-240V~50Hz **650 W**
 1.1 l/min **20.7 MPa**
 310 mm AIRLESS BEZ-POWETRZNY
 250 mm
 7.5 m

• For wall paints
 • Do farb ściennych

$L_{pa} = 93,3 \pm 3,0$ dB; $L_{wa} = 104,3 \pm 3,0$ dB; $a_n = \leq 2,5$ m/s²

YATO	[W]	
YT-82560	650	1

EN Nozzle
 PL Dysza
 DE Duese
 RU Корно
 CZ Třyska
 HU Szórófej
 RO Duză
 FR Buse pour pistolet à peinture
 IT Ugello regolabile per verniciatura
 ES Boquilla
 CN 喷嘴柱

5 PCS **513** **515** **517** **519** **521**



For YT-82560, YT-82562
 Dla YT-82560, YT-82562

YATO	
YT-82563	20

EN Nozzle
 PL Dysza
 DE Duese
 RU Корно
 CZ Třyska
 HU Szórófej
 RO Duză
 FR Buse pour pistolet à peinture
 IT Ugello regolabile per verniciatura
 ES Boquilla
 CN 喷嘴柱

3 PCS **517**



For YT-82560, YT-82562
 Dla YT-82560, YT-82562

YATO	
YT-82564	20

EN Pressure hose for paint
PL Wąż ciśnieniowy do farby
DE Schlauch für Farbe
RU Шланг высокого давления
CZ Střikací hadice
HU Permetező tömlő
RO Furtun de presiune
FR Tuyau de pulvérisation
IT Tubo flessibile di pressione per verniciatura
ES Manguera de rociado
CN 高压输漆管

83 MPa max. 65°C 15 m



For YT-82562
Dla YT-82562

YATO	
YT-82565	5

EN Airless spray gun extension
PL Przedłużka do pistoletu natryskowego
DE Sprühpistole Erweiterung
RU Удлинитель для пистолета-распылителя
CZ Prodlužovák pro postřikovací pistoli
HU Toldósár szórópisztolyhoz
RO Prelungitor pistol airless
FR Extension de pistolet de pulvérisation de peinture
IT Prolunga per pistola a spruzzo
ES Extensión de pistola pulverizadora de pintura
CN 延长杆

3 PCS 300 mm 450 mm 600 mm AI



YATO	L [mm]	
YT-82567	300, 450, 600	10

EN Multi-purpose oscillating tool
PL Wielofunkcyjne narzędzie oscylacyjne
DE Multifunktionales Oszillationswerkzeug
RU Многофункциональный инструмент
CZ Multifunkční oscilační nářadí
HU Multifunkciós rezgő szerszám

RO Unealtă multifuncțională oscilantă
FR Outil multifonctions oscillant
IT Oscillante strumento multifunzione
ES Herramienta oscilatoria multiusos
CN 多功能锯

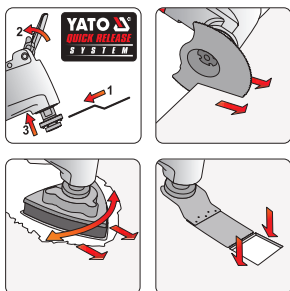

230-240V~50Hz 300 W
1500-22000 min⁻¹ 2m

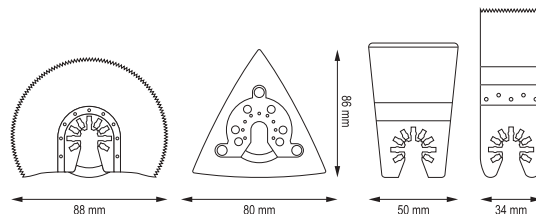

$L_{PA} = 89,2 \pm 3,0$ dB; $L_{WA} = 100,2 \pm 3,0$ dB; $a_n = 4,464 \pm 1,5$ m/s²

YATO	[W]	
YT-82220	300	4

EN Multi-purpose oscillating tool
PL Wielofunkcyjne narzędzie oscylacyjne
DE Multifunktionales Oszillationswerkzeug
RU Многофункциональный инструмент
CZ Multifunkční oscilační nářadí
HU Multifunkciós rezgő szerszám

RO Unealtă multifuncțională oscilantă
FR Outil multifonctions oscillant
IT Oscillante strumento multifunzione
ES Herramienta oscilatoria multiusos
CN 多功能锯

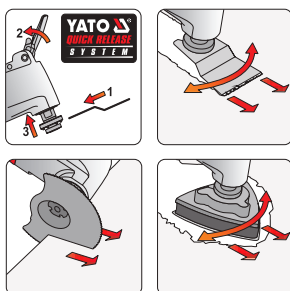

230-240V~50Hz 500 W
8000-16000 min⁻¹

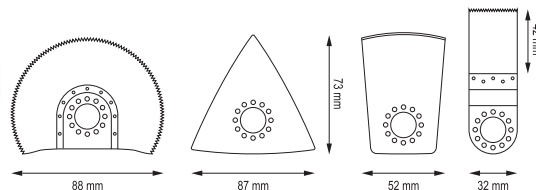

$L_{PA} = 106,4 \pm 3,0$ dB; $L_{WA} = 117,4 \pm 3,0$ dB; $a_n = 12,71 \pm 1,5$ m/s²

YATO	[W]	
YT-82223	500	5



For YT-82560, YT-82562
Dla YT-82560, YT-82562

YATO	
YT-82566	20

EN Airless spray gun extension
PL Przedłużka do pistoletu natryskowego
DE Sprühpistole Erweiterung
RU Удлинитель для пистолета-распылителя
CZ Prodlužovák pro postřikovací pistoli
HU Toldósár szórópisztolyhoz
RO Prelungitor pistol airless
FR Extension de pistolet de pulvérisation de peinture
IT Prolunga per pistola a spruzzo
ES Extensión de pistola pulverizadora de pintura
CN 延长杆

2 PCS 1000 mm 1800 mm AI





YATO	L [mm]	
YT-82568	1000, 1800	25

• Additional vacuum system
• Opcjonalny system odsysania

EN Industrial vacuum cleaner
 PL Odkurzacz przemysłowy
 DE Industriesauger
 RU Пылосос промышленный
 CZ Průmyslový vysavač
 HU Ipari porszívó
 RO Aspirator industrial
 FR Aspirateur eau et poussières
 IT Aspirapolvere industriale
 ES Aspirador industrial
 CN 吸尘器

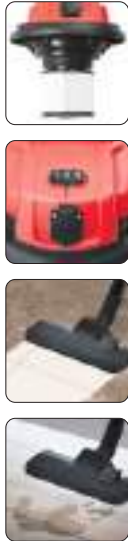
220-240V~50/60Hz **1400 W** **18 kPa** **20 L** **WET AND DRY SUCHO I MOKRO** **2000 W**
IPX4 **4.5 m** 



YATO 	[W]	
YT-85700	1400	1

EN Industrial vacuum cleaner
 PL Odkurzacz przemysłowy
 DE Industriesauger
 RU Пылосос промышленный
 CZ Průmyslový vysavač
 HU Ipari porszívó
 RO Aspirator industrial
 FR Aspirateur eau et poussières
 IT Aspirapolvere industriale
 ES Aspirador industrial
 CN 吸尘器

220-240V~50/60Hz **1400 W** **18 kPa** **30 L** **WET AND DRY SUCHO I MOKRO** **2000 W**
IPX4 **4.5 m** 



YATO 	[W]	
YT-85701	1400	1

EN Industrial vacuum cleaner
 PL Odkurzacz przemysłowy
 DE Industriesauger
 RU Пылосос промышленный
 CZ Průmyslový vysavač
 HU Ipari porszívó
 RO Aspirator industrial
 FR Aspirateur eau et poussières
 IT Aspirapolvere industriale
 ES Aspirador industrial
 CN 吸尘器

220-240V~50/60Hz **2400 W** **18 kPa** **70 L** **WET AND DRY SUCHO I MOKRO** **ADJUSTABLE POWER REGULACJA MOCY**
IPX4 **6 m** 



YATO 	[W]	
YT-85710	2400	1

EN Industrial vacuum cleaner
 PL Odkurzacz przemysłowy
 DE Industriesauger
 RU Пылосос промышленный
 CZ Průmyslový vysavač
 HU Ipari porszívó
 RO Aspirator industrial
 FR Aspirateur eau et poussières
 IT Aspirapolvere industriale
 ES Aspirador industrial
 CN 多功能吸尘器

220-240V~50/60Hz **1600 W** **18 kPa** **30 L** **WET AND DRY SUCHO I MOKRO** **BLOW FUNCTION FUNKCJA DMUCHAWY**
2000 W **IPX4** **5 m** 



YATO 	[W]	
YT-85715	1600	1

EN Industrial vacuum cleaner
PL Odkurzacz przemysłowy
DE Industriesauger
RU Пылесос промышленный
CZ Průmyslový vysavač
HU Ipari porzsívó
RO Aspirator industrial
FR Aspirateur eau et poussières
IT Aspirapolvere industriale
ES Aspirador industrial
CN 吸尘器

220-240V~
50-60Hz

1600
W

30 L

HEPA

2000 W

IPX4

7.5 m

- Self cleaning filter
- HEPA filter
- Automatyyczny otrząsacz filtra
- Filtr HEPA



YATO	[W]	
YT-85716	1600 / 3600	1

EN Synthetic vacuum bags
PL Worek do odkurzacza syntetyczny
DE Staubsaugerbeutel, synthetisch
RU Синтетический мешок для пылесоса
CZ Sáčky do vysavačů syntetické
HU Szintetikus porzsák
RO Sac sintetic pt. aspirator
FR Sac synthétique pour aspirateur
IT Sacchetti sintetici per aspirapolvere
ES Bolsas sintéticas para aspiradoras
CN 合成吸尘器袋



3
PCS

YATO	For / Dla	
YT-85730	YT-85710	20
YT-85731	YT-85701	20
YT-85733	78874	20
YT-85735	YT-85700, 78872	24

EN Synthetic vacuum bag
PL Worek do odkurzacza syntetyczny
DE Staubsaugerbeutel, synthetisch
RU Синтетический мешок для пылесоса
CZ Syntetický sáček do vysavače
HU Szintetikus porzsák
RO Sac sintetic pt. aspirator
FR Sac synthétique pour aspirateur
IT Sacchetto per aspirapolvere sintetico
ES Bolsa sintética para aspiradora
CN 合成吸尘器袋



1
PC

For YT-85715
Dla YT-85715

YATO	
YT-85741	100

EN Multifunctional vacuum cleaner for pond
PL Odkurzacz wielofunkcyjny do oczka wodnego
DE Multifunktions-Teichsauger
RU Водный пылесос для пруда
CZ Multifunkční vysavač do vodního očka
HU Többfunkciós vízszívó porzsívó
RO Aspirator multifuncțional pt. iazuri
FR Aspirateur multifonction pour étangs
IT Aspirapolvere multifunzione per laghetti artificiali
ES Aspiradora multiuso para estanques
CN 水池吸尘器

220-240V~
50/60Hz

1400
W

18
kPa

30 L

WET
AND DRY
SUCHO
I MOKRO

BLOW
FUNCTION
FUNKCJA
DMUCHAWY

IPX4

4.5 m

- Wet and dry floor nozzle (width: 30 cm)
- Round brush (rotating head)
- Crevice nozzle
- Nozzle for cleaning pond
- Long hose (430 cm)
- Drainage hose (200 cm)
- Plastic tubes (4 PCS)
- Pond debris bag
- Cloth filter
- Sponge filter

- Dysza podłogowa do odkurzania na suchu i mokro (szerokość: 30 cm)
- Szczotka okrągła (obracana głowica)
- Dysza szczelinowa
- Dysza do czyszczenia oczka wodnego
- Długi wąż (430 cm)
- Wąż drenazowy (200 cm)
- Rury z tworzywa sztucznego (4 szt.)
- Torba na zanieczyszczenia
- Filtr materiałowy
- Filtr piankowy



YATO	[W]	
YT-85720	1400	1

EN Synthetic vacuum bag
PL Worek do odkurzacza syntetyczny
DE Staubsaugerbeutel, synthetisch
RU Синтетический мешок для пылесоса
CZ Syntetický sáček do vysavače
HU Szintetikus porzsák
RO Sac sintetic pt. aspirator
FR Sac synthétique pour aspirateur
IT Sacchetto per aspirapolvere sintetico
ES Bolsa sintética para aspiradora
CN 合成吸尘器袋



1
PC

For YT-85715
Dla YT-85715

YATO	
YT-85740	100

EN Synthetic vacuum bag
PL Worek do odkurzacza syntetyczny
DE Staubsaugerbeutel, synthetisch
RU Синтетический мешок для пылесоса
CZ Syntetický sáček do vysavače
HU Szintetikus porzsák
RO Sac sintetic pt. aspirator
FR Sac synthétique pour aspirateur
IT Sacchetto per aspirapolvere sintetico
ES Bolsa sintética para aspiradora
CN 合成吸尘器袋



1
PC

For YT-85716
Dla YT-85716

YATO	
YT-85744	100

EN Paper vacuum bags
 PL Worki do odkurzacza papierowe
 DE Staubsaugerbeutel, papier
 RU Бумажные пылесборники
 CZ Sáčky do vysavačů papírové
 HU Papír porzsák
 RO Sac hartie pt aspirator
 FR Sacs en papier pour aspirateur
 IT Sacchetti di carta per aspirapolvere
 ES Bolsas de papel para aspiradoras
 CN 纸质吸尘器袋



YATO	For / Dla	
YT-85732	YT-85701, 78874	24
YT-85736	YT-85700, 78872	24

EN Sponge filter and cloth filter
 PL Filtr piankowy i filtr materiałowy
 DE Schaumstoff- und Gewebefilter
 RU Тканевый фильтр
 CZ Pěnový filtr a látkový filtr
 HU Habszűrő és szövet szűrő
 RO Filtru de burete și filtru de pânză
 FR Filtre en mousse et en tissu
 IT Filtro in schiuma e filtro in tessuto
 ES Filtro de espuma y filtro de tela
 CN 尘袋&过滤海绵套装



For YT-85720
 Dla YT-85720

YATO	
YT-85750	20

EN Vacuum filter
 PL Filtr do odkurzacza
 DE Staubsaugerfilter
 RU Фильтр для пылесоса
 CZ Filtr do vysavače
 HU Porszívó szűrő
 RO Filtru aspirator
 FR Filtre pour aspirateur
 IT Filtro per aspirapolvere
 ES Filtro para aspiradoras
 CN 吸尘器过滤器



For YT-85715
 Dla YT-85715

YATO	
YT-85743	100

EN Wall paper stripper
 PL Parownica do usuwania tapet
 DE Dampftapetenblöser
 RU Паровой аппарат для снятия обоев
 CZ Parní odstraňovač tapet
 HU Tapétaeltávolító

RO Aparat de dezlipit tapet
 FR Décolleuse à papiers peints
 IT Vaporizzatore per la rimozione di carta da parati
 ES Separador de fondos de pantalla
 CN 剥墙纸机



YATO	[W]	
YT-82320	2000	4

EN Vacuum filter
 PL Filtr do odkurzacza
 DE Staubsaugerfilter
 RU Фильтр для пылесоса
 CZ Filtr do vysavače
 HU Porszívó szűrő
 RO Filtru aspirator
 FR Filtre pour aspirateur
 IT Filtro per aspirapolvere
 ES Filtro para aspiradoras
 CN 吸尘器过滤器



YATO	For / Dla	
YT-85738	YT-85700, YT-85701	1
YT-85739	YT-85710	1

EN Vacuum filter
 PL Filtr do odkurzacza
 DE Staubsaugerfilter
 RU Фильтр для пылесоса
 CZ Filtr do vysavače
 HU Porszívó szűrő
 RO Filtru aspirator
 FR Filtre pour aspirateur
 IT Filtro per aspirapolvere
 ES Filtro para aspiradoras
 CN 吸尘器过滤器



HEPA



For YT-85715
 Dla YT-85715

YATO	
YT-85742	100

EN Vacuum filter
 PL Filtr do odkurzacza
 DE Staubsaugerfilter
 RU Фильтр для пылесоса
 CZ Filtr do vysavače
 HU Porszívó szűrő
 RO Filtru aspirator
 FR Filtre pour aspirateur
 IT Filtro per aspirapolvere
 ES Filtro para aspiradoras
 CN 吸尘器过滤器



HEPA

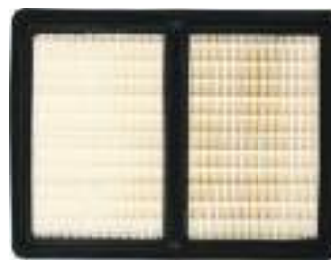

For YT-85716
 Dla YT-85716

YATO	
YT-85745	22

EN Hot knife for polystyrene foam
 PL Nóż termiczny do styropianu
 DE Thermmesser für Styropor
 RU Термомож для пенопласта
 CZ Termický nůž na polystyrén
 HU Polisztrólvágó hőkés

RO Cuțit termic pt. polistiren
 FR Couteau thermique pour polystyrène
 IT Coltello a caldo per taglio polistirolo
 ES Cuchillo térmico para poliestireno
 CN 热切割刀

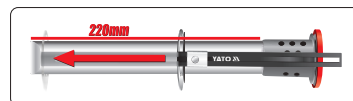
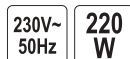

YATO	[W]	Max. cutting length / Maks. długość cięcia [mm]	
YT-82190	220	220	10

EN Cordless heat gun
PL Opalarka akumulatorowa
DE Akku-Heissluftgebläse
RU Фен технический аккумуляторный
CZ Akumulátorová opalovací pistole
HU Akkus hőlégfúvó
RO Pistol aer cald cu acumulator
FR Décapeur thermique sans-fil
IT Pistola termica a batteria
ES Pistola de calor a batería
CN 热风枪



18 V
Li-Ion
550 °C
100 l/min

Battery not included
Onze Akku / Bez akumulatora
Bez baterije / Bez aku
Akumulator nêkûl
Fără baterie / Sans batterie
Senza batteria / Sin bateria
没有电池

18V
Li-Ion

YATO	[V d.c.]	
YT-82285	18	10

EN Hot air gun
PL Opalarka
DE Heissluftpistole
RU Строительный фен
CZ Opalovací stroj
HU Hőlégfúvó

RO Fion pt. ars vopsea
FR Décapeur thermique
IT Pistola termica
ES Secadora
CN 热风枪



230-240V~
50Hz
2000 W
550 °C
500 l/min

YATO	[W]	
YT-82288	2000	10

EN Hot air gun with accessories
PL Opalarka z akcesoriami
DE Heissluftpistole
RU Строительный фен в наборе
CZ Opalovací stroj s příslušenstvím
HU Hőlégfúvó tartozékokkal

RO Fion cu accesorii pt. ars vopsea
FR Décapeur thermique avec accessoires
IT Pistola termica con accessori
ES Secadora con accesorios
CN 热风枪

230-240V~
50Hz
2000 W
550 °C
500 l/min



YATO	[W]	
YT-82291	2000	5

EN Hot air gun with accessories
PL Opalarka z akcesoriami
DE Heissluftpistole
RU Строительный фен в наборе
CZ Opalovací stroj s příslušenstvím
HU Hőlégfúvó tartozékokkal

RO Fion cu accesorii pt. ars vopsea
FR Décapeur thermique avec accessoires
IT Pistola termica con accessori
ES Secadora con accesorios
CN 热风枪

230-240V~
50Hz
2000 W
550 °C
500 l/min
LED



YATO	[W]	
YT-82292	2000	5

EN Hot air gun with accessories
PL Opalarka z akcesoriami
DE Heissluftpistole
RU Строительный фен в наборе
CZ Opalovací stroj s příslušenstvím
HU Hőlégfúvó tartozékokkal

RO Fion cu accesorii pt. ars vopsea
FR Décapeur thermique avec accessoires
IT Pistola termica con accessori
ES Secadora con accesorios
CN 热风枪

230-240V~
50Hz
2000 W
600 °C
500 l/min
LCD



YATO	[W]	
YT-82293	2000	5

EN Hot air gun with accessories
PL Opalarka z akcesoriami
DE Heissluftpistole
RU Строительный фен в наборе
CZ Opalovací stroj s příslušenstvím
HU Hőlégfúvó tartozékokkal
RO Fion cu accesorii pt. ars vopsea
FR Décapeur thermique avec accessoires
IT Pistola termica con accessori
ES Secadora con accesorios
CN 热风枪

220-240V~
50Hz
2000 W
450/600 °C
250-500 l/min
1.8 m



YATO	[W]	
YT-82294	2000	5

EN Hot air gun with accessories
 PL Opalarka z akcesoriami
 DE Heissluftpistole
 RU Строительный фен в наборе
 CZ Opalovací stroj s příslušenstvím
 HU Hőlégfúvó tartozékokkal
 RO Fion cu accesorii pt. ars vopseaua
 FR Décapeur thermique avec accessoires
 IT Pistola termica con accessori
 ES Secadora con accesorios
 CN 热风枪

220-240V~50Hz
2000 W
 50-600 °C
 250-500 l/min
 TEMPERATURE REGULATION REGULACJA TEMPERATURY
 1.8 m



YATO	[W]	
YT-82295	2000	5

EN Hot air gun accessories set
 PL Zestaw akcesoriów do opalarki
 DE Heißluftpistolen-Zubehörsatz
 RU Набор принадлежностей для строительного фена
 CZ Sada příslušenství pro horkovzdušnou pistoli
 HU Hőlégfúvó tartozékcsészlet
 RO Set accesorii pt. pistol aer cald
 FR Accessoires de décapeur thermique
 IT Set di accessori per pistola termica
 ES Juego de accesorios para pistola de aire caliente
 CN 喷嘴五件套

5 PCS



For YT-82294, YT-82295, YT-82296
 Dla YT-82294, YT-82295, YT-82296

YATO		
YT-82301		50

EN Electric glue gun
 PL Pistolet do klejenia
 DE Heissklebepistole
 RU Пистолет для клея
 CZ Pistole na lepení
 HU Ragasztópisztoly
 RO Pistol pt. lipit
 FR Pistolet à colle
 IT Pistola colla
 ES Pistola de cola
 CN 热胶枪

230-240V~50Hz
30(450) W
 100-200 °C
 3-5 min
 20 g/min
 11 mm
 1.5 m



Fitting glue sticks: see chapter 12
 Pasujące wkłady klejowe: patrz rozdział 12

YATO	[W]	Ø [mm]	[g/min]	
YT-82403	30 (450)	11	20	6

EN Blower
 PL Dmuchawa
 DE Gebläse
 RU Воздуходувка сетевая
 CZ Zahradní fukar
 HU Légfúvó
 RO Sulfiantă
 FR Souffleur
 IT Soffiatore
 ES Soplador
 CN 吹吸机



$L_{pA} = 82,1 \pm 2,5$ dB; $L_{wA} = 95,0 \pm 2,5$ dB; $ah = 2,994 \pm 1,5$ m/s²



220-240V~50/60Hz
600 W
 6000-16000 min²
 4 m³/min
 SUCTION FUNCTION FUNKCJA ZASYSANIA
 BLOW FUNCTION FUNKCJA DUCHAWY
 2 m



YATO	[W]	
YT-85170	600	4

EN Electric glue gun
 PL Pistolet do klejenia
 DE Heissklebepistole
 RU Пистолет для клея
 CZ Pistole na lepení
 HU Ragasztópisztoly
 RO Pistol pt. lipit
 FR Pistolet à colle
 IT Pistola colla
 ES Pistola de cola
 CN 热胶枪

230V~50Hz
35(400) W
 150-200 °C
 3-6 min
 15 g/min
 2x
 Ø 11 mm

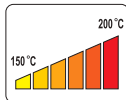

Fitting glue sticks: see chapter 12
 Pasujące wkłady klejowe: patrz rozdział 12

YATO	[W]	Ø [mm]	[g/min]	
YT-82401	35 (400)	11	15	12/24

EN Electric glue gun
 PL Pistolet do klejenia
 DE Heissklebepistole
 RU Пистолет для клея
 CZ Pistole na lepení
 HU Ragasztópisztoly
 RO Pistol pt. lipit
 FR Pistolet à colle
 IT Pistola colla
 ES Pistola de cola
 CN 热胶枪

230V~50Hz
20(80) W
 180-200 °C
 3-5 min
 15 g/min
 3x
 Ø 11 mm



Fitting glue sticks: see chapter 12
 Pasujące wkłady klejowe: patrz rozdział 12

YATO	[W]	Ø [mm]	[g/min]	
YT-82402	20 (80)	11	15	12/48

EN Gasoline generator
PL Generator prądowórczy
DE Stromgenerator
RU Генератор тока
CZ Generátor vytvářející proud
HU Áramfejlesztő generátorhoz

RO Generator de curent
FR Groupe électrogène
IT Generatore di corrente
ES Generador de corriente
CN 发电机



$L_{pa} = 72,7 \pm 2,03$ dB; $L_{wa} = 92,2 \pm 2,03$ dB

YATO
YT-85451 1

EN Gasoline generator
PL Generator prądowórczy
DE Stromgenerator
RU Генератор тока
CZ Generátor vytvářející proud
HU Áramfejlesztő generátorhoz

RO Generator de curent
FR Groupe électrogène
IT Generatore di corrente
ES Generador de corriente
CN 发电机



$L_{pa} = 73,6 \pm 2,0$ dB; $L_{wa} = 93,2 \pm 2,0$ dB

YATO
YT-85453 1

EN Gasoline generator
PL Generator prądowórczy
DE Stromgenerator
RU Генератор тока
CZ Generátor vytvářející proud
HU Áramfejlesztő generátorhoz

RO Generator de curent
FR Groupe électrogène
IT Generatore di corrente
ES Generador de corriente
CN 发电机



$L_{pa} = 75,0 \pm 2,62$ dB; $L_{wa} = 93,7 \pm 2,62$ dB

YATO
YT-85460 1

EN Inverter generator
PL Generator prądowórczy inwerterowy
DE Stromgenerator
RU Генератор тока
CZ Generátor vytvářející proud
HU Áramfejlesztő generátorhoz

RO Generator de curent
FR Générateur à essence
IT Generatore di corrente
ES Generador de corriente
CN 逆变发电机

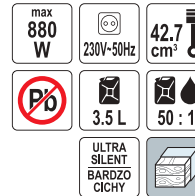

**ULTRA SILENT
BARDOZO
CICHY**
8.5 kg

$L_{pa} = 70,46 \pm 0$ dB; $L_{wa} = 90,46 \pm 0$ dB

YATO
YT-85481 1

EN Electric heater
PL Nagrzewnica elektryczna
DE Elektrisches Heizgerät
RU Электрический обогреватель
CZ Elektrický ohřivač
HU Elektromos hőlégfűvő
RO Incalzitör electric
FR Chauffage électrique
IT Riscaldatore elettrico
ES Calentador eléctrico
CN 用电取暖器

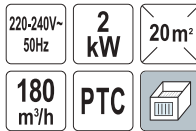

YATO [W] 2000 8

EN Electric heater
PL Nagrzewnica elektryczna
DE Elektrisches Heizgerät
RU Электрический обогреватель
CZ Elektrický ohřivač
HU Elektromos hőlégfűvő
RO Incalzitör electric
FR Chauffage électrique
IT Riscaldatore elettrico
ES Calentador eléctrico
CN 用电取暖器

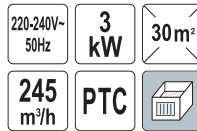

YATO [W] 3000 1

EN Electric heater
PL Nagrzewnica elektryczna
DE Elektrisches Heizgerät
RU Электрический обогреватель
CZ Elektrický ohřivač
HU Elektromos hőlégfűvő
RO Incalzitör electric
FR Chauffage électrique
IT Riscaldatore elettrico
ES Calentador eléctrico
CN 用电取暖器

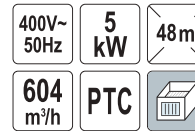

YATO [W] 5000 1

EN Electric heater
 PL Nagrzewnica elektryczna
 DE Elektrisches Heizgerät
 RU Электрический обогреватель
 CZ Elektrický ohřivač
 HU Elektromos hőlégfűvő
 RO Incalzitör electric
 FR Chauffage électrique
 IT Riscaldatore elettrico
 ES Calentador eléctrico
 CN 用电取暖器



220-240V~50Hz **3 kW** 30m² 322 m³/h PTC 

YATO 	[W]	
YT-99720	3000	1

EN Gas fired heater
 PL Nagrzewnica gazowa
 DE Gasheizgerät
 RU Газовый обогреватель
 CZ Plynový ohřivač
 HU Gáztüzelésű hőlégfűvő
 RO Incalzitör pe gaz
 FR Chauffage à gaz
 IT Riscaldatore a gas
 ES Calentador de aire por gas
 CN 燃气取暖器

220-240V~50Hz **15 kW** 70 MPa 320 m³/h 



YATO 	[kW]	
YT-99730*	15	1

EN Gas fired heater
 PL Nagrzewnica gazowa
 DE Gasheizgerät
 RU Газовый обогреватель
 CZ Plynový ohřivač
 HU Gáztüzelésű hőlégfűvő
 RO Incalzitör pe gaz
 FR Chauffage à gaz
 IT Riscaldatore a gas
 ES Calentador de aire por gas
 CN 燃气取暖器

220-240V~50Hz **30 kW** 70 MPa 650 m³/h 



YATO 	[kW]	
YT-99733*	30	1

EN Direct oil fired heater
 PL Nagrzewnica olejowa
 DE Ölheizgerät
 RU Масляный обогреватель
 CZ Olejový ohřivač
 HU Olajfűtés
 RO Incalzitör cu ulei
 FR Chauffage à huile
 IT Riscaldatore a olio
 ES Calentador de aire aceite
 CN 燃油取暖器



220-240V~50Hz **30 kW** 750 m³/h 2.4 kg/h 38 L 

YATO 	[kW]	
YT-99740*	30	1

EN Direct oil fired heater
 PL Nagrzewnica olejowa
 DE Ölheizgerät
 RU Масляный обогреватель
 CZ Olejový ohřivač
 HU Olajfűtés
 RO Incalzitör cu ulei
 FR Chauffage à huile
 IT Riscaldatore a olio
 ES Calentador de aire aceite
 CN 燃油取暖器



220-240V~50Hz **50 kW** 1100 m³/h 4.0 kg/h 50 L 

YATO 	[kW]	
YT-99743*	50	1

EN Gasoline water pump
PL Pompa spalinowa
DE Pumpe mit verbrennungsmotor
RU Бензонасос
CZ Čerpadlo se spalovacím motorem
HU Robbanómotoros szivattyú
RO Pompa cu motor cu ardere internă
FR Pompe à eau à essence
IT Motopompa
ES Bomba de combustion
CN 汽油抽水

4.0 kW	3600 min ⁻¹	208 cm ³
50 mm	Q max 500 l/min	Q max 30 m ³ /h
25 m	8 m	3.6 L

EN Gasoline water pump
PL Pompa spalinowa
DE Pumpe mit verbrennungsmotor
RU Бензонасос
CZ Čerpadlo se spalovacím motorem
HU Robbanómotoros szivattyú
RO Pompa cu motor cu ardere internă
FR Pompe à eau à essence
IT Motopompa
ES Bomba de combustion
CN 汽油抽水

4.0 kW	3600 min ⁻¹	208 cm ³
80 mm	Q max 800 l/min	Q max 50 m ³ /h
20 m	8 m	3.6 L

EN Gasoline water pump
PL Pompa spalinowa
DE Pumpe mit verbrennungsmotor
RU Бензонасос
CZ Čerpadlo se spalovacím motorem
HU Robbanómotoros szivattyú
RO Pompa cu motor cu ardere internă
FR Pompe à eau à essence
IT Motopompa
ES Bomba de combustion
CN 汽油抽水

4.0 kW	3600 min ⁻¹	208 cm ³
100 mm	Q max 1300 l/min	Q max 78 m ³ /h
20 m	8 m	3.6 L



$L_{pA} = 82,1 \pm 3,0$ dB; $L_{wA} = 95,4 \pm 3,0$ dB

YATO
YT-85401 1



$L_{pA} = 81,9 \pm 3,0$ dB; $L_{wA} = 95,0 \pm 3,0$ dB

YATO
YT-85402 1



$L_{pA} = 81,9 \pm 3,0$ dB; $L_{wA} = 94,9 \pm 3,0$ dB

YATO
YT-85403 1

EN Submersible pump for dirty water and wastewater
PL Pompa zatapialna do wody brudnej i ścieków
DE Tauchpumpe für Schmutzwasser
RU Погружной насос для грязной воды
CZ Ponorné čerpadlo pro odpadní vody
HU Búvárszivattyú szennyvíz
RO Pompă submersibilă pt. apă uzată
FR Pompe submersible pour eaux usees
IT Pompa sommersa per acque reflue
ES Bomba sumergible para aguas residuales
CN 污水切割泵

230V~50Hz	400 W
Q max 12000 l/h	



Δ	Q [l/h]
3	12000
4	9000
5	6000
6	3000
7	1500
7.5	500

YATO [W] [l/h] H max. [m] 1
YT-85349 400 12000 7.5 1

EN Submersible pump for dirty water and wastewater
PL Pompa zatapialna do wody brudnej i ścieków
DE Tauchpumpe für Schmutzwasser
RU Погружной насос для грязной воды
CZ Ponorné čerpadlo pro odpadní vody
HU Búvárszivattyú szennyvíz
RO Pompă submersibilă pt. apă uzată
FR Pompe submersible pour eaux usees
IT Pompa sommersa per acque reflue
ES Bomba sumergible para aguas residuales
CN 污水切割泵

230V~50Hz	750 W
Q max 16000 l/h	



Δ	Q [l/h]
0	16000
1	15000
2	14000
3	13500
4	12500
5	11500
6	11000
7	10500
8	9500
9	8000
10	5500
11	3500
12	2000
13	500

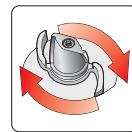

YATO [W] [l/h] H max. [m] 1
YT-85350 750 16000 13 1

EN Dirty water submersible pump
PL Pompa zatapialna do wody brudnej
DE Tauchpumpe für Schmutzwasser
RU Погружной насос для грязной воды
CZ Ponorné čerpadlo pro špinavú vodu
HU Búvárszivattyú
RO Pompă submersibilă pt. apă murdara
FR Pompe submersible pour eaux polluées
IT Pompa sommersa per acque reflue
ES Bomba sumergible para agua sucia
CN 清污两用潜水泵

220-240V~50Hz	400 W
Q max 11000 l/h	



Δ	Q [l/h]
0	11000
1	10500
2	10000
3	9500
4	9000
5	8000
6	7000
7	6000
8	5000
9	4000
10	3000
11	2000
12	1000



YATO [W] [l/h] H max. [m] 4
YT-85330 400 11000 5.8 4

EN Deep well pump
PL Pompa głębinowa
DE Tiefbrunnenpumpe
RU Глубинный насос
CZ Čerpadlo do vrtaných studní
HU Búvárszivattyú
RO Pompă submersibilă
FR Pompe de puits profond
IT Pompa sommergibile
ES Bomba agua sumergible
CN 深井泵

230V~50Hz	370 W
Q max 5400 l/min	
20 m	



YATO [W] [l/h] 1
YT-85300 370 5400 1

EN Deep well pump
 PL Pompa głębinowa
 DE Tiefbrunnenpumpe
 RU Глубинный насос
 CZ Čerpadlo do vrtaných studní
 HU Búvárszivattyú
 RO Pompa submersibilă
 FR Pompe de puits profond
 IT Pompa sommergibile
 ES Bomba agua sumergible
 CN 深井泵



230V~50Hz **550 W**
 Q max 6000 l/h 20m



YATO	[W]	[l/h]	
YT-85301	550	6000	1

EN Dirty water submersible pump
 PL Pompa zatopialna do wody brudnej
 DE Tauchpumpe für Schmutzwasser
 RU Погружной насос для грязной воды
 CZ Ponorné čerpadlo pro špinavou vodu
 HU Búvárszivattyú
 RO Pompa submersibilă pt. apă murdara
 FR Pompe submersible pour eaux polluées
 IT Pompa sommersa per acque reflue
 ES Bomba sumergible para agua sucia
 CN 清污两用潜水泵



220-240V~50Hz **900 W**
 Q max 18000 l/h

Δ	Q [l/h]
0	18000
1	17000
2	16000
3	15000
4	14000
5	12000
6	11000
7	10000
8	8000
9	7000
10	6000
11	5000
12	4000
13	3000
14	2000
15	100



YATO	[W]	[l/h]	H max. [m]	
YT-85333	900	18000	8.9	4

EN Dirty water submersible pump
 PL Pompa zatopialna do wody brudnej
 DE Tauchpumpe für Schmutzwasser
 RU Погружной насос для грязной воды
 CZ Ponorné čerpadlo pro špinavou vodu
 HU Búvárszivattyú
 RO Pompa submersibilă pt. apă murdara
 FR Pompe submersible pour eaux polluées
 IT Pompa sommersa per acque reflue
 ES Bomba sumergible para agua sucia
 CN 不锈钢潜水泵 (内置式开关)



230V~50Hz **750 W**
 Q max 11000 l/h

Δ	Q [l/h]
0	11000
1	10500
2	10000
3	9500
4	9000
5	8500
6	8000
7	7500
8	7000
9	6500
10	6000
11	5000
12	4000
13	3000
14	2000
15	1000

YATO	[W]	[l/h]	H max. [m]	
YT-85341	750	11000	8.5	3

EN Dirty water submersible pump
 PL Pompa zatopialna do wody brudnej
 DE Tauchpumpe für Schmutzwasser
 RU Погружной насос для грязной воды
 CZ Ponorné čerpadlo pro špinavou vodu
 HU Búvárszivattyú
 RO Pompa submersibilă pt. apă murdara
 FR Pompe submersible pour eaux polluées
 IT Pompa sommersa per acque reflue
 ES Bomba sumergible para aguas sucias
 CN 不锈钢潜水泵 (浮球开关)



230V~50Hz **1100 W** **Q max 17000 l/h**

Δ	Q [l/h]
0	17000
1	16500
2	16000
3	15000
4	14000
5	13000
6	12000
7	11000
8	10000
9	9000
10	8000
11	7000
12	6000
13	5000
14	4000
15	3000
16	2000
17	1000

YATO	[W]	[l/h]	H max. [m]	
YT-85343	1100	17000	10	3

EN Brass straight connection
 PL Króciec mosiężny do pomp
 DE Messingstutzen für Pumpen
 RU Латунный патрубок для насосов
 CZ Mosazná přípojka pro čerpadla
 HU Sárgaréz csatlakozó szivattyúkhöz
 RO Conector alama
 FR Raccord de pompe en laiton
 IT Raccordo in ottone per pompe
 ES Conector de latón para bombas
 CN 铜接头

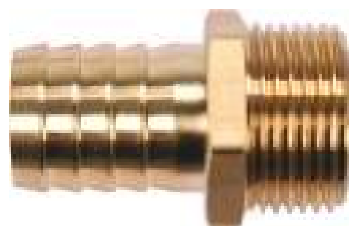

1" 25mm BRASS MOSIADZ

YATO	
YT-85395	10/80

EN Drill pump
 PL Pompka na wiertarkę
 DE Bohrerpumpe
 RU Насос для дрели
 CZ Čerpadlo na vrtačku
 HU Szivattyú fúróra
 RO Pompa de foraj
 FR Pompe pour perceuse
 IT Pompa per trapano
 ES Bomba para taladradora
 CN 手转泵



Q max 2.4 m³/h **3.0m** **3400 min⁻¹(max)** **8 mm**

YATO	
YT-89000	6/60

- EN Nylon head jet pump
- PL Pompa ogrodowa z głowicą nylonową
- DE Gartenpumpe
- RU Огородный насос
- CZ Zahradní čerpadlo
- HU Kerti szivattyúhoz
- RO Pompa de apa
- FR Bomba de jardin con cabeza nylon
- IT Pompa da giardino
- ES Pompe a eau de surface
- CN 花园泵 (含电子压力开关)



230V~
50Hz
600 W
Q max
3100 l/h

$L_{pa} = 69,43 \pm 1,49$ dB; $L_{wa} = 82,35 \pm 1,49$ dB

YATO	[W]	[l/h]	H max. [m]	
YT-85360	600	3100	35	1

- EN Hydrophore
- PL Hydrofor
- DE Hauswasserwerk
- RU Гидрофор
- CZ Vodárna domácí
- HU Hydrovor
- RO Hidrofor
- FR Groupe de surpression
- IT Idroforo
- ES Grupo de presión
- CN 花园泵



230V~
50Hz
1200 W
1" / 25mm
4000 l/min
50m
max °C 35
19L
IPX4
INOX

$L_{pa} = 69,43 \pm 1,49$ dB; $L_{wa} = 82,35 \pm 1,49$ dB

YATO	[W]	[l/h]	H max. [m]	
YT-85370	1200	4000	50	1

- EN Cordless submersible garden pump
- PL Akumulatorowa pompa ogrodowa zatapialna
- DE Akku-Garten-Tauchpumpe
- RU Аккумуляторный садовый насос
- CZ Akumulátorové zahradní čerpadlo
- HU Akkumulátoros kertiről szivattyú
- RO Pompă de grădină submersibilă fără fir
- FR Pompe de jardin submersible sans-fil
- IT Pompa sommersa da giardino a batteria
- ES Bomba de batería sumergible para jardín
- CN 充电式潜水泵



18 V
Li-Ion
2 bar
2500 l/h
max °C 35
20m
1.5m
IPX8

Battery not included
Ohne Akku / Bez akumulatora
Bez baterije / Bez aku
Akkumulátor nélkül
Fără baterie / Sans batterie
Senza batteria / Sin battery
没有电池

$L_{pa} < 70$ dB

YATO	[V d.c.]	
YT-85281	18	4

- EN Cordless barrel pump
- PL Akumulatorowa pompa do deszczówki
- DE Akku-Regenfasspumpe
- RU Аккумуляторный насос для дождевой воды
- CZ Akumulátorové čerpadlo na dešťovou vodu
- HU Akkumulátoros esővíz szivattyú
- RO Pompă de butoi fără fir
- FR Pompe à eau de pluie sans-fil
- IT Pompa per acqua piovana a batteria
- ES Bomba de batería para tanques de agua de precipitación
- CN 充电式潜水泵



18 V
Li-Ion
2 bar
2000 l/h
max °C 35
21m
1.5m
IPX8

Battery not included
Ohne Akku / Bez akumulatora
Bez baterije / Bez aku
Akkumulátor nélkül
Fără baterie / Sans batterie
Senza batteria / Sin battery
没有电池

$L_{pa} < 70$ dB

YATO	[V d.c.]	
YT-85283	18	4

- EN High pressure washer
- PL Myjka ciśnieniowa
- DE Hochdruckreiniger
- RU Мойка высокого давления
- CZ Tlakový mycí stroj
- HU Vízszóró
- RO Instrument cu presiune pt. spălat
- FR Nettoyeur haute pression
- IT Idropulitrice
- ES Lavadora de presión
- CN 高压清洗机

$L_{pa} = 77,3 \pm 3,0$ dB;
 $L_{wa} = 84,3 \pm 3,0$ dB;
 $a_n = 2,08 \pm 1,5$ m/s²



230-240V~
50Hz
1500 W
12 MPa (max.)
8.0 MPa
5 l/min
IPX5

YATO	[W]	
YT-85910	1500	1

- EN High pressure washer
- PL Myjka ciśnieniowa
- DE Hochdruckreiniger
- RU Мойка высокого давления
- CZ Tlakový mycí stroj
- HU Vízszóró
- RO Instrument cu presiune pt. spălat
- FR Nettoyeur haute pression
- IT Idropulitrice
- ES Lavadora de presión
- CN 高压清洗机

$L_{pa} = 85,8 \pm 3,0$ dB;
 $L_{wa} = 95,39 \pm 3,0$ dB;
 $a_n = 2,64$ m/s²



220-240V~
50Hz
2000 W
15 MPa (max.)
10 MPa
6 l/min
IPX5

YATO	[W]	
YT-85915	2000	1

EN Cordless pressure washer
 PL Akumulatorowa myjka ciśnieniowa
 DE Akku-Hochdruckreiniger
 RU Аккумуляторная мойка высокого давления
 CZ Bateriový tlakový čistič
 HU Akkumulátoros mosó
 RO Aparat de spălat
 cu presine cu acumulator
 FR Nettoyeur à haute pression sans-fil
 IT Idropulitrice a batteria
 ES Limpiadora a vapor a batería
 CN 高压清洗机

18 V
Li-Ion!

IN (max.)
0.5 MPa

OUT
2.3 MPa

6 m

SUCTION FUNCTION
FUNKCJA ZASYSANIA



Battery not included
 Ohne Akku / Bez akumulatora
 Eez Gamapeu / Bez aku
 Akkumulátor nélkül
 Fără baterie / Sans batterie
 Senza batteria / Sin batería
 没有电池

18V
Li-Ion!

YATO	[V d.c.]	
YT-85930	18	6

EN Cordless leaf vacuum / blower
 PL Akumulatorowy odkurzacz / dmuchawa do liści
 DE Akku-Laubsauger / Laubbläser
 RU Аккумуляторная воздуходувка-пылесос
 CZ Akumulatorový vysavač / odfučovač listí
 HU Akkumulátoros lombszívó / lombfúvó
 RO Sulfanta / aspirator cu acumulator
 FR Aspirateur-souffleur de feuilles sans-fil
 IT Aspiratore / soffiatore per foglie senza fili
 ES Aspiradora / soplador de hojas de batería
 CN 锂电无刷吹吸机

2in1
36 V
2x 18 V
Li-Ion!

6000-12500
min¹

8
m³/min

45 L



- Leaves compress volume function 8:1
- Blowing air speed: 230 km/h
- Funkcja zmniejszania objętości liści 8:1
- Prędkość wydmuchiwanego powietrza: 230 km/h

Battery not included
 Ohne Akku / Bez akumulatora
 Eez Gamapeu / Bez aku
 Akkumulátor nélkül
 Fără baterie / Sans batterie
 Senza batteria / Sin batería
 没有电池

18V
Li-Ion!

$L_{pA} = 80,5 \pm 3,0$ dB; $L_{wA} = 92,7 \pm 3,0$ dB; $a_h = 2,37 \pm 1,5$ m/s²

YATO	[V d.c.]	
YT-85175	36 (18 x2)	1

EN Cordless leaf blower
 PL Akumulatorowa dmuchawa do liści
 DE Akku-Laubbläser
 RU Аккумуляторная воздуходувка
 CZ Akumulatorový odfučovač listí
 HU Akkumulátoros lombfúvó
 RO Sulfanta cu acumulator
 FR Souffleur de feuilles sans-fil
 IT Soffiatore per foglie senza fili
 ES Soplador de hojas de batería
 CN 吹风机

18 V
Li-Ion!

13000
min¹
16000
min¹

400-570
m³/h

100-126
km/h

TURBO



$L_{pA} = 76,3 \pm 3,0$ dB; $L_{wA} = 90,9 \pm 2,67$ dB; $a_h = 0,49 \pm 1,5$ m/s²

YATO	[V d.c.]	Battery capacity / Pojemność akumulatora [mAh]	⚡ [h]	Battery quantity / Liczba akumulatorów w zestawie	
YT-85176	18	4000	2	1	4
YT-85177	18	-	-	brak	4

EN Cordless leaf blower
 PL Akumulatorowa dmuchawa do liści
 DE Akku-Laubbläser
 RU Аккумуляторная воздуходувка
 CZ Akumulatorový odfučovač listí
 HU Akkumulátoros lombfúvó
 RO Sulfanta cu acumulator
 FR Souffleur de feuilles sans-fil
 IT Soffiatore per foglie senza fili
 ES Soplador de hojas de batería
 CN 吹风机

36 V
2x 18 V
Li-Ion!

19000
min¹

900
m³/h

200
km/h

TURBO

SOFT GRIP
MIEKKI
UCHWYT



$L_{pA} = 76,3 \pm 3,0$ dB; $L_{wA} = 90,9 \pm 2,67$ dB; $a_h = 0,49 \pm 2,67$ m/s²

YATO	[V d.c.]	
YT-85179	36 (18 x2)	2

Battery not included
 Ohne Akku / Bez akumulatora
 Eez Gamapeu / Bez aku
 Akkumulátor nélkül
 Fără baterie / Sans batterie
 Senza batteria / Sin batería
 没有电池

18V
Li-Ion!

EN Cordless backpack sprayer
 PL Akumulatorowy opryskiwacz plecakowy
 DE Akku-Drucksprüher
 RU Аккумуляторный ранцевый опрыскиватель
 CZ Aku postřikovač
 HU Akkumulátoros hátí permetező
 RO Pulverizator cu acumulator
 FR Pulvérisateur à batterie
 IT Pompa irroratrice a spalla a batteria
 ES Pulverizador de mochila a batería
 CN 充电式喷雾器

2in1
2w1

18 V
Li-Ion!

12 L

≤1.5
l/min

max
7 m



- Water tank
- Sprayer
- Hydronetka
- Opryskiwacz

Battery not included
 Ohne Akku / Bez akumulatora
 Eez Gamapeu / Bez aku
 Akkumulátor nélkül
 Fără baterie / Sans batterie
 Senza batteria / Sin batería
 没有电池

18V
Li-Ion!

$L_{pA} = 60,0 \pm 3,0$ dB; $L_{wA} = 70,0 \pm 3,0$ dB; $a_h = 0,74 \pm 1,5$ m/s²

YATO	[V d.c.]	
YT-86211	18	1

EN Battery sprayer with solar panel
 PL Opryskiwacz akumulatorowo-solarny
 DE Solar-Akku-Sprüngerät
 RU Оприскиватель аккумуляторный на солнечной батарее
 CZ Postřikovač bateriového solární
 HU Akkumulátoros-napelemes permetező
 RO Vermorel cu alimentare solara
 FR Pulvérisateur à batterie et à dos solaire
 IT Pompa irroratrice a batteria e ad energia solare
 ES Pulverizador solar a batería
 CN 电动太阳能喷雾器

12 V

0.15-0.4 MPa

3.1
l/min

16 L

8.0
Ah

PP

SS
STAINLESS STEEL
STAL NIERDZEWNA



YATO	[V d.c.]	
YT-86220	12	1

EN Cordless telescopic pole saw
PL Akumulatorowa okrzyszawka na wysięgniku
DE Akku-Teleskop-Hochentaster
RU Аккумуляторный телескопический высоторез
CZ Akumulátorová teleskopická vyvětřovací pila
HU Akkus magassági ágfavágó fűrész
RO Ferăstrăie cu lanț cu telescop cu acumulator
FR Elagueuse sur perche télescopique sans-fil
IT Decespugliatore telescopico a batteria
ES Sierra de pértiga telescópica a batería
CN 充电式高枝锯

18V
Li-Ion



$L_{pa} = 78,2 \pm 3,0$ dB; $L_{wa} = 91,2 \pm 2,36$ dB; $a_n = 2,109 \pm 1,5$ m/s²

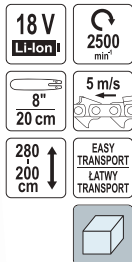

YATO	[V d.c.]	Battery capacity / Pojemność akumulatora [mAh]	⚡ [h]	Battery quantity / Liczba akumulatorów w zestawie	
YT-82836	18	2000	1	1	2
YT-82837	18	-	-	brak	2

EN Pole saw
PL Okrzyszawka na wysięgniku
DE Teleskop-Hochentaster
RU Телескопический высоторез
CZ Teleskopická vyvětřovací pila
HU Magassági ágfavágó fűrész
RO Ferăstrăie cu lanț cu telescop
FR Elagueuse sur perche télescopique
IT Decespugliatore telescopico
ES Sierra de pértiga telescópica
CN 高枝锯



$L_{pa} = 88,7 \pm 3,0$; $L_{wa} = 100,3 \pm 3,0$; $a_n = 1,353 \pm 1,5 / 2,134 \pm 1,5$ m/s²

YATO	[W]	
YT-84800	710	2

EN Cordless grass trimmer
PL Akumulatorowa podkaszarka do trawy
DE Akku-Rasentrimmer
RU Аккумуляторный триммер
CZ Akumulátorová strunová sekačka
HU Akkus szegélynyíró
RO Trimmer de gazon cu acumulator
FR Débroussaillouse sans-fil
IT Tagliabordi a batteria
ES Desbrozadora a batería
CN 充电式打草机



Battery not included
Obrno Akku / Bez akumulatora
Bez bateriepiu / Bez aku
Akumulator năilăi
Fără baterie / Senza baterie
Senza batteria / Sin batería
没有电池

18V
Li-Ion

YATO	[V d.c.]	
YT-85015	18	4

EN Cordless garden multi tool
PL Akumulatorowe wielofunkcyjne narzędzie ogrodowe
DE Akku-Garten-Multifunktionsgerät
RU Многофункциональный аккумуляторный садовый инструмент
CZ Akumulátorové multifunkční zahradní nářadí
HU Többfunkciós akkumulátoros kerti szerszám
RO Unealta multifunctionala de gradina cu acumulator
FR Outil multifonction de jardin sans-fil
IT Utensile multifunzione da giardinaggio a batteria
ES Herramienta de jardín multifuncional a batería
CN 园林多功能机

18V
Li-Ion



$L_{pa} = 74,5 \pm 3,0$ dB; $L_{wa} = 89,6 \pm 3,0$ dB; $a_n = 1,446 \pm 1,5$ m/s² (Hedge trimmer / Nożyce do żywoplotu);
 $L_{pa} = 74,5 \pm 3,0$ dB; $L_{wa} = 88,0 \pm 3,0$ dB; $a_n = 1,190 \pm 1,5$ m/s² (Pruner / Okrzyszawka)

YATO	[V d.c.]	Battery capacity / Pojemność akumulatora [mAh]	⚡ [h]	Battery quantity / Liczba akumulatorów w zestawie	
YT-828390	18	2000	1	1	2
YT-828391	18	-	-	brak	2

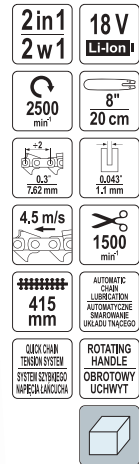

EN Cordless grass trimmer
PL Akumulatorowa podkaszarka do trawy
DE Akku-Rasentrimmer
RU Аккумуляторный триммер
CZ Akumulátorová strunová sekačka
HU Akkus szegélynyíró
RO Trimmer de gazon cu acumulator
FR Débroussaillouse sans-fil
IT Tagliabordi a batteria
ES Desbrozadora a batería
CN 充电式打草机

18V
Li-Ion



$L_{pa} = 85,0 \pm 3,0$ dB; $L_{wa} = 93,0 \pm 3,0$ dB; $a_n = 2,5 \pm 1,5$ m/s²

YATO	[V d.c.]	Battery capacity / Pojemność akumulatora [mAh]	⚡ [h]	Battery quantity / Liczba akumulatorów w zestawie	
YT-82830	18	2000	1	1	2
YT-82831	18	-	-	brak	2

EN Nylon blades
PL Nożyki nylonowe
DE Nylonmesser Set
RU Сменные ножи для триммера
CZ Náhradní nože pro využínače
HU Nylon kések
RO Lame din nailon
FR Lames en nylon
IT Piedi di nylon
ES Cuchillas de nylon
CN 尼龙打草刀片

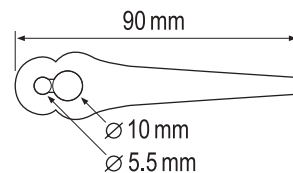

20
PCS

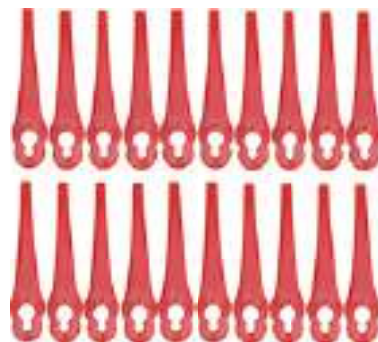

For YT-85015
Dla YT-85015

YATO		
YT-85016		250

EN Cordless brushcutter
 PL Kosa akumulatorowa
 DE Akku-Motorsense
 RU Аккумуляторная коса
 CZ Akumulátorový křovinořez
 HU Akkus fűkasza
 RO Motocoasa cu acumulator
 FR Débroussaillouse sans-fil
 IT Decesupugliatore a batteria
 ES Motoguadaña a batería
 CN 充电式打草机

36 V
2x 18V
Li-Ion

5800
min¹

255x25.4
mm

340
mm

1.6 mm
3 m

BRUSHLESS
MOTOR
SIŁNIK BEZ-
SZCZOTKOWY



Battery not included
 Ohne Akku / Bez akumulatora
 Bez baterii / Bez aku
 Akumulátor nélkül
 Fără baterie / Sans batterie
 Senza batteria / Sin batería
 没有电池

18V
Li-Ion

$L_{pa} = 79,1 \pm 3,0 / 83,0 \pm 3,0$ dB; $L_{wa} = 88,4 \pm 2,31 / 92,5 \pm 1,92$ dB; $a_h = 1,35 \pm 1,5 / 1,11 \pm 1,5$ m/s²

YATO	[V d.c.]	
YT-85010	36 (18 x2)	1

EN Cordless pruning shears
 PL Akumulatorowy sekatör
 DE Akku-Astscherer
 RU Секатор аккумуляторный
 CZ Akumulátorové zahradní nůžky
 HU Akkumulátoros metszőolló
 RO Foarfeca de tăiat cu acumulator
 FR Sécateur électrique sans-fil
 IT Cesoia da potatura a batteria
 ES Tijeras de poda eléctricas a batería
 CN 充电式无刷园林剪

18 V
Li-Ion

30 mm

SK5

BRUSHLESS
MOTOR
SIŁNIK BEZ-
SZCZOTKOWY

OVERHEATING
PROTECTION
ZABEZPIECZENIE
PRZEZGRZANIE

SOFT
GRIP
MIĘKKI
UCHWYT



18V
Li-Ion

$L_{pa} = 67,0 \pm 3,0$ dB; $L_{wa} = 78,0 \pm 3,0$ dB; $a_h = 1,5 \pm 1,5$ m/s²

YATO	[V d.c.]	Battery capacity / Pojemność akumulatora [mAh]	⚡ [h]	Battery quantity / Liczba akumulatorów w zestawie	
YT-828377	18	2000	1	1	8
YT-828378	18	-	-	brak	10

EN Cutting blade for pruning shears
 PL Ostrze tnące do sekatora
 DE Ersatzklinge für Gartenschere
 RU Лезвие сменное для секатора
 CZ Nůž do zahradních nůžek
 HU Metszőollóhoz tartálék penge
 RO Lama rezerva pt. foarfeca crengi
 FR Lame de rechange pour sécateurs
 IT Lama di ricambio per cesoie
 ES Hoja de recambio para podadera
 CN 园林剪刀片

SK5



For YT-828377, YT-828378
 Dla YT-828377, YT-828378

YATO	
YT-828375	300

EN Cordless grass and shrub shears
 PL Akumulatorowe nożyce do trawy i krzewów
 DE Akku Gras- und Strauchschere
 RU Аккумуляторные ножницы для травы и кустов
 CZ Akumulátorové nůžky na trávu a keře
 HU Akkumulátoros fű- és bokornyíró
 RO Trimmer cu acumulator pt. iarba si gard viu
 FR Cisaille à gazon et taille-buissons sans-fil
 IT Cesoia per erba e arbusti a batteria
 ES Tijeras a batería para hierba y arbustos
 CN 修枝剪草机



18 V
Li-Ion

2in1

1200
min¹

200
mm

100mm

8 mm

SK5

18V
Li-Ion

YATO	[V d.c.]	Battery capacity / Pojemność akumulatora [mAh]	⚡ [h]	Battery quantity / Liczba akumulatorów w zestawie	
YT-828355	18	2000	1	1	8
YT-828356	18	-	-	brak	8

EN Cordless hedge trimmer
 PL Akumulatorowe nożyce do żywoplotu
 DE Akku-Heckenschere
 RU Аккумуляторный кусторез
 CZ Akumulátorové nůžky na živý plot
 HU Akkus sövényvágó
 RO Foarfeca de tăiat gard viu cu acumulator
 FR Taille-haie sans-fil
 IT Tagliasiepi a batteria
 ES Cortasetos inalámbrico
 CN 锂电绿篱机



18 V
Li-Ion

1550
min¹

450
mm

16 mm

ROTATING
HANDLE
OBROTOWY
UCHWYT

SOFT
GRIP
MIĘKKI
UCHWYT

18V
Li-Ion

$L_{pa} = 84,4 \pm 3,0$ dB; $L_{wa} = 92,0 \pm 3,0$ dB; $a_h = 2,27 \pm 1,5$ m/s²

YATO	[V d.c.]	Battery capacity / Pojemność akumulatora [mAh]	⚡ [h]	Battery quantity / Liczba akumulatorów w zestawie	
YT-828331	18	2000	1	1	2
YT-828332	18	-	-	brak	2

EN Cordless hedge trimmer
PL Akumulatorowe nożyce do żywoplotu
DE Akku-Heckenschere
RU Аккумуляторный кусторез
CZ Akumulátorové nůžky na živý plot
HU Akkus sövényvágó
RO Foarfeca de tăiat gard viu cu acumulator
FR Taille-haie sans-fil
IT Tagliasiepi a batteria
ES Cortasetos inalámbrico
CN 锂电绿篱机

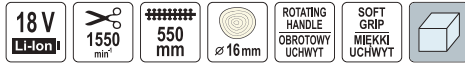

18V
Li-Ion

$L_{PA} = 84,4 \pm 3,0$ dB; $L_{WA} = 92,0 \pm 3,0$ dB; $a_n = 2,27 \pm 1,5$ m/s²

YATO [V d.c.]	Battery capacity / Pojemność akumulatora [mAh]	⚡ [h]	Battery quantity / Liczba akumulatorów w zestawie	📦
YT-828333	18 2000	1	1	2
YT-828334	18 -	-	brak	2

EN Cordless hedge trimmer
PL Akumulatorowe nożyce do żywoplotu
DE Akku-Heckenschere
RU Аккумуляторный кусторез
CZ Akumulátorové nůžky na živý plot
HU Akkus sövényvágó
RO Foarfeca de tăiat gard viu cu acumulator
FR Taille-haie sans-fil
IT Tagliasiepi a batteria
ES Cortasetos inalámbrico
CN 锂电绿篱机



18V
Li-Ion

$L_{PA} = 80,0 \pm 3,0$ dB; $L_{WA} = 87,0 \pm 3,0$ dB; $a_n = 3,5 \pm 1,5$ m/s²

YATO [V d.c.]	Battery capacity / Pojemność akumulatora [mAh]	⚡ [h]	Battery quantity / Liczba akumulatorów w zestawie	📦
YT-82832	18 2000	1	1	2
YT-82833	18 -	-	brak	2

EN Electric hedge trimmer
PL Elektryczne nożyce do żywoplotu
DE Elektrische Heckenschere
RU Электрический кусторез
CZ Elektrické nůžky na živý plot
HU Elektromos sövényvágó olló
RO Foarfeca electrica pt. gard viu
FR Taille-haie électrique
IT Tagliasiepi elettrico
ES Cortasetos electrico
CN 篱笆剪



$L_{PA} = 91,0 \pm 3,0$ dB(A); $L_{WA} = 98,9 \pm 3,0$ dB(A); $a_n = 3,344 \pm 1,5 / 4,308 \pm 1,5$ m/s²

YATO [W]	📦
YT-84770	4

EN Cordless hedge trimmer
PL Akumulatorowe nożyce do żywoplotu
DE Akku-Heckenschere
RU Аккумуляторный кусторез
CZ Akumulátorové nůžky na živý plot
HU Akkus sövényvágó
RO Foarfeca de tăiat gard viu cu acumulator
FR Taille-haie sans-fil
IT Tagliasiepi a batteria
ES Cortasetos inalámbrico
CN 锂电绿篱机



18V
Li-Ion

$L_{PA} = 82,7 \pm 3,0$ dB; $L_{WA} = 90,5 \pm 2,02$ dB; $a_n = 4,08 \pm 1,5 / 3,09 \pm 1,5$ m/s²

YATO [V d.c.]	📦
YT-828353	36 (18 x 2) 2

EN Cordless hedge trimmer
PL Akumulatorowe nożyce do żywoplotu
DE Akku-Teleskop-Heckenschere
RU Аккумуляторный телескопический кусторез
CZ Akumulátorové teleskopické nůžky na živý plot
HU Akkus magassági sövényvágó
RO Foarfeca de tăiat gard viu telescopică cu acumulator
FR Taille-haie télescopique sans-fil
IT Tagliasiepi telescopico a batteria
ES Tijera cortasetos telescópicas a batería
CN 锂电绿篱机



18V
Li-Ion



$L_{PA} = 77,3 \pm 3,0$ dB; $L_{WA} = 88,1 \pm 3,0$ dB; $a_n = 1,5 \pm 1,5$ m/s²

YATO [V d.c.]	Battery capacity / Pojemność akumulatora [mAh]	⚡ [h]	Battery quantity / Liczba akumulatorów w zestawie	📦
YT-82834	18 2000	1	1	2
YT-82835	18 -	-	brak	2

- EN Pole hedge trimmer
- PL Nożyce do żywopłotu na wysięgniku
- DE Teleskop-Heckenschere
- RU Телескопический кусторез
- CZ Teleskopické nůžky na živý plot
- HU Magassági sövénynyágó
- RO Foarfecă de tăiat gard viu telescopică
- FR Taille-haie télescopique
- IT Tagliasiepi telescopico
- ES Tijera cortasetos telescópicas
- CN 高枝绿篱机



- 230-240V~ 50Hz
- 600 W
- 1500 min⁻¹
- 510 mm
- ∅ 20 mm
- 274 / 207 cm
- 65Mn
- HEAD ANGLE ADJUSTMENT REGULACJA KĄTA GŁOWICY
- TELESCOPIC HANDLE UCHWYT TELESKOPOWY
- SOFT GRIP MIEKKI UCHWYT



$L_{pa} = 84,7 \pm 3,0$; $L_{max} = 96,0 \pm 3,0$; $a_n = 2,74 \pm 1,5 / 2,84 \pm 1,5$ m/s²

YATO	[W]	
YT-84790	600	2

- EN Cordless chainsaw
- PL Akumulatorowa pilarka łańcuchowa
- DE Akku-Kettensäge
- RU Аккумуляторная цепная пила
- CZ Akumulátorová řetězová píla
- HU Akkus láncfűrész
- RO Ferăstrău cu lanț cu acumulator
- FR Tronçonneuse sans-fil
- IT Motosega a batteria
- ES Inalámbrico motosierra
- CN 锂电电链锯套装

- 36 V 2x 18V Li-Ion
- 4500 min⁻¹
- 14" 36 cm
- 3/8" 9,52 mm
- 52
- 0,043" 1,1 mm
- 0.17 L
- AUTOMATIC CHAIN LUBRICATION AUTOMATYCZNE SMAROWANIE UKŁADU TŁACZEGO
- QUICK CHAIN TENSION SYSTEM SYSTEM SZYBKIEGO NAPIĘCIA ŁAŃCUCHA



18V Li-Ion

$L_{pa} = 81,9 \pm 3,0$ dB; $L_{max} = 92,8 \pm 2,6$ dB; $a_n = 2,57 \pm 1,5 / 4,92 \pm 1,5$ m/s²

YATO	[V d.c.]	Battery capacity / Pojemność akumulatora [mAh]	⚡ [h]	Battery quantity / Liczba akumulatorów w zestawie	
YT-82812	36 (18 x2)	2000	1	2	2
YT-82813	36 (18 x2)	-	-	brak	2

- EN Cordless mini chainsaw
- PL Akumulatorowa minipilarka łańcuchowa
- DE Mini Akku-Kettensäge
- RU Аккумуляторная цепная мини пила
- CZ Akumulátorová mini řetězová píla
- HU Akkus mini láncfűrész
- RO Mini fierăstrău cu lanț cu acumulator
- FR Mini-tronçonneuse sans-fil
- IT Mini motosega a batteria
- ES Mini motosierra inalámbrica
- CN 充电式无刷单手锯

- 18V Li-Ion
- 4" 10 cm
- 4,8 m/s
- SOFT GRIP MIEKKI UCHWYT
- 26
- 0,043" 1,1 mm



18V Li-Ion

$L_{pa} = 78,0 \pm 3,0$ dB; $L_{max} = 89,0 \pm 3,0$ dB; $a_n = 3,425 \pm 1,5$ m/s²

YATO	[V d.c.]	Battery capacity / Pojemność akumulatora [mAh]	⚡ [h]	Battery quantity / Liczba akumulatorów w zestawie	
YT-828135	18	2000	1	1	4
YT-828136	18	-	-	brak	4

- EN Cordless chainsaw
- PL Akumulatorowa pilarka łańcuchowa
- DE Akku-Kettensäge
- RU Аккумуляторная цепная пила
- CZ Akumulátorová řetězová píla
- HU Akkus láncfűrész
- RO Ferăstrău cu lanț cu acumulator
- FR Tronçonneuse sans-fil
- IT Motosega a batteria
- ES Inalámbrico motosierra
- CN 锂电电链锯套装

- 18V Li-Ion
- 12" 30 cm
- 6,5 m/s
- SOFT GRIP MIEKKI UCHWYT
- 45
- 0,043" 1,1 mm
- AUTOMATIC CHAIN LUBRICATION AUTOMATYCZNE SMAROWANIE UKŁADU TŁACZEGO
- QUICK CHAIN TENSION SYSTEM SYSTEM SZYBKIEGO NAPIĘCIA ŁAŃCUCHA
- DOUBLE BRAKE PODWOJNY HAMULEC



18V Li-Ion

$L_{pa} = 97,0 \pm 3,0$ dB; $L_{max} = 102,0 \pm 2,66$ dB; $a_n = 5,407 \pm 1,5 / 4,137 \pm 1,5$ m/s²

YATO	[V d.c.]	Battery capacity / Pojemność akumulatora [mAh]	⚡ [h]	Battery quantity / Liczba akumulatorów w zestawie	
YT-828137	18	4000	2	1	2
YT-828138	18	-	-	brak	2

- EN Brushless cordless chainsaw
- PL Bezszczotkowa pilarka łańcuchowa akumulatorowa
- DE Bürstenlose Akku-Kettensäge
- RU Бесщеточная аккумуляторная цепная пила
- CZ Akumulátorová bezkartáčová řetězová píla
- HU Szénkefe nélküli akkus láncfűrész
- RO Drujba cu acumulator fara perii
- FR Tronçonneuse sans-fil sans charbon
- IT Motosega a batteria senza spazzole
- ES Motosierra a batería sin escobillas
- CN 锂电链锯

- 36 V 2x 18V Li-Ion
- 8000 min⁻¹
- 16" 40 cm
- 15 m/s
- 0.25 L
- 56
- 0,043" 1,1 mm
- AUTOMATIC CHAIN LUBRICATION AUTOMATYCZNE SMAROWANIE UKŁADU TŁACZEGO
- QUICK CHAIN TENSION SYSTEM SYSTEM SZYBKIEGO NAPIĘCIA ŁAŃCUCHA
- BRUSHLESS MOTOR SILNIK BEZ SZCZOTKOWY
- SOFT GRIP MIEKKI UCHWYT



18V Li-Ion

$L_{pa} = 95,5 \pm 3,0$ dB(A); $L_{max} = 102,4 \pm 2,54$ dB(A); $a_n = 3,25 \pm 1,5 / 5,19 \pm 1,5$ m/s²

YATO	[V d.c.]	Battery capacity / Pojemność akumulatora [mAh]	⚡ [h]	Battery quantity / Liczba akumulatorów w zestawie	
YT-828131	36 (18 x2)	4000	2	2	2
YT-828132	36 (18 x2)	-	-	brak	2

EN Electric chainsaw
PL Elektryczna pilarka łańcuchowa
DE Elektrische Kettensäge
RU Электрическая цепная пила
CZ Elektrická řetězová pila
HU Elektromos láncfűrész
RO Ferăstrău electric cu lanț
FR Tronçonneuse électrique
IT Motosega elettrica
ES Sierra de cadena eléctrica
CN 电链锯



$L_{pa} = 96,0 \pm 3,0$ dB; $L_{wa} = 104,3 \pm 2,64$ dB; $a_n = 5,15 \pm 1,5 / 5,08 \pm 1,5$ m/s²

YATO	[W]	
YT-84868	1600	2

EN Electric chainsaw
PL Elektryczna pilarka łańcuchowa
DE Elektrische Kettensäge
RU Электрическая цепная пила
CZ Elektrická řetězová pila
HU Elektromos láncfűrész
RO Ferăstrău electric cu lanț
FR Tronçonneuse électrique
IT Motosega elettrica
ES Sierra de cadena eléctrica
CN 电链锯

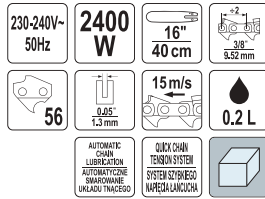

$L_{pa} = 96,5 \pm 3,0$ dB; $L_{wa} = 104,5 \pm 2,36$ dB; $a_n = 6,55 \pm 1,5 / 6,02 \pm 1,5$ m/s²

YATO	[W]	
YT-84872	2400	2

EN Cordless lawn mower
PL Kosiarka akumulatorowa
DE Akku-Rasenmäher
RU Аккумуляторная газонокосилка
CZ Akumulátorová sekačka na trávu
HU Fűnyíró akkumulátoros
RO Masina de tuns iarba cu acumulator
FR Tondeuse sans-fil
IT Rasaerba a batteria
ES Cortacésped de batería
CN 锂电草坪机套装



$L_{pa} = 76,1 \pm 3,0$ dB(A); $L_{wa} = 89,2 \pm 2,31$ dB(A); $a_n = 0,54 \pm 1,5 / 0,68 \pm 1,5$ m/s²

YATO	[V d.c.]	Battery capacity / Pojemność akumulatora [mAh]	⚡ [h]	Battery quantity / Liczba akumulatorów w zestawie	
YT-85222	36 (18 x2)	4000	2	2	1
YT-85223	36 (18 x2)	-	-	brak	1

EN Cordless lawn mower
PL Kosiarka akumulatorowa
DE Akku-Rasenmäher
RU Аккумуляторная газонокосилка
CZ Akumulátorová sekačka na trávu
HU Fűnyíró akkumulátoros
RO Masina de tuns iarba cu acumulator
FR Tondeuse sans-fil
IT Rasaerba a batteria
ES Cortacésped de batería
CN 锂电草坪机套装

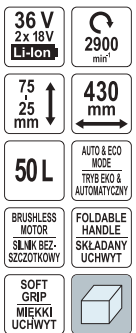

$L_{pa} = 72,8 \pm 3,0$ dB(A); $L_{wa} = 87,1 \pm 2,95$ dB(A); $a_n = 0,34 \pm 1,5 / 0,37 \pm 1,5$ m/s²

YATO	[V d.c.]	Battery capacity / Pojemność akumulatora [mAh]	⚡ [h]	Battery quantity / Liczba akumulatorów w zestawie	
YT-85224	36 (18 x2)	4000	2	2	1
YT-85225	36 (18 x2)	-	-	brak	1

EN Cordless lawn mower
PL Kosiarka akumulatorowa
DE Akku-Rasenmäher
RU Аккумуляторная газонокосилка
CZ Akumulátorová sekačka na trávu
HU Fűnyíró akkumulátoros
RO Masina de tuns iarba cu acumulator
FR Tondeuse sans-fil
IT Rasaerba a batteria
ES Cortacésped de batería
CN 锂电草坪机套装



$L_{pa} = 77,9 \pm 3,0$ dB; $L_{wa} = 90,2 \pm 1,85$ dB; $a_n = 0,5 \pm 1,5$ m/s²

YATO	[V d.c.]	Battery capacity / Pojemność akumulatora [mAh]	⚡ [h]	Battery quantity / Liczba akumulatorów w zestawie	
YT-85220	36 (18 x2)	2000	1	2	1
YT-85221	36 (18 x2)	-	-	brak	1

EN Electric grass trimmer
 PL Podkaszarka elektryczna
 DE Elektro-Rasentrimmer
 RU Электрический триммер
 CZ Elektrická sekačka
 HU Elektromos fűnyíró
 RO Cositoare electrică
 FR Coupe-herbe
 IT Decespugliatore elettrico
 ES Segadora eléctrica
 CN 打草机



230-240V~
50Hz

250 W

12500 min⁻¹

220 mm

1.2 mm

6 m

EN Electric grass trimmer
 PL Podkaszarka elektryczna
 DE Elektro-Rasentrimmer
 RU Электрический триммер
 CZ Elektrická sekačka
 HU Elektromos fűnyíró
 RO Cositoare electrică
 FR Coupe-herbe
 IT Decespugliatore elettrico
 ES Segadora eléctrica
 CN 打草机



230-240V~
50Hz

550 W

10000 min⁻¹

300 mm

1.6 mm

6 m

126
106 cm

2 POSITIONS
POZYCJE

HEAD ANGLE
ADJUSTMENT
REGULACJA
KĄTA GŁOWICY

$L_{PA} = 70,21 \pm 0,88$ dB; $L_{WA} = 90,18 \pm 0,88$ dB; $a_n = 1,853 \pm 1,5 / 2,835 \pm 1,5$ m/s²

$L_{PA} = 73,45 \pm 1,52$ dB; $L_{WA} = 93,17 \pm 1,52$ dB; $a_n = 4,556 \pm 1,5 / 4,306 \pm 1,5$ m/s²

YATO	[W]	
YT-85230	250	12

YATO	[W]	
YT-85234	550	4

EN Electric chainsaw 2 in 1
 PL Elektryczna pilarka łańcuchowa 2 w 1
 DE 2 in 1 elektrische Kettensäge
 RU Электрическая цепная пила 2 в 1
 CZ Elektrická řetězová píla 2 v 1
 HU 2 az 1-ben elektromos láncfűrész
 RO Ferăstrău electric cu lanț 2 in 1
 FR Tronçonneuse électrique 2 en 1
 IT Motosega elettrica 2 in 1
 ES 2 en 1 sierra de cadena eléctrica
 CN 2合1电链锯

2 in 1
2 w 1

230-240V~
50Hz

750 W

40" / 25 cm

12 m/s

170 / 110 cm

40

0.043" / 1.1 mm

QUICK CHAIN
TENSION SYSTEM
SYSTEM SZORÍTÓRÓZS
NÁRÉPILÁNCOLÓZÁS

SOFT GRIP
MIEKKI
UCHWYT



$L_{PA} = 89,5 \pm 3,0$ dB; $L_{WA} = 102,7 \pm 2,47$ dB; $a_n = 2,67 \pm 1,5 / 3,32 \pm 1,5$ m/s²

EN Electric chainsaw
 PL Elektryczna pilarka łańcuchowa
 DE Elektrische Kettensäge
 RU Электрическая цепная пила
 CZ Elektrická řetězová píla
 HU Elektromos láncfűrész
 RO Ferăstrău electric cu lanț
 FR Tronçonneuse électrique
 IT Motosega elettrica
 ES Sierra de cadena eléctrica
 CN 电链锯

230-240V~
50Hz

2000 W

7000 min⁻¹

16" / 40 cm

13 m/s

0.11 L

0.03" / 1.3 mm

AUTOMATIC CHAIN
LUBRICATION
AUTOMATYCZNE
SMAROWANIE
ŁLĄCZKI łańCOWEJ



$L_{PA} = 90,2 \pm 3,0$ dB; $L_{WA} = 103,2 \pm 3,0$ dB; $a_n = 8,393 \pm 1,5 / 6,002 \pm 1,5$ m/s²

YATO	[W]	
YT-84877	750	1

YATO	[W]	
YT-84870	2000	2

EN Electric lawn mower
 PL Kosiarka elektryczna
 DE Elektrischer grasmäher
 RU Электрокосилка
 CZ Elektrická sekačka
 HU Elektromos fűnyíró-gép
 RO Cositoare electrica pt. iarba
 FR Tondeuse à gazon électrique
 IT Rasaerba elettrico
 ES Contracesped
 CN 电动草坪机



230V~
50/60Hz

1300 W

3400 min⁻¹

330 mm

60 / 40 / 20 mm

30 L

140 mm

$L_{PA} = 82,3 \pm 3,0$ dB; $L_{WA} = 93,1 \pm 1,91$ dB; $a_n = 2,72 \pm 1,5$ m/s²

YATO	[W]	
YT-85200	1300	1

EN Electric lawn mower
 PL Kosiarka elektryczna
 DE Elektrischer grasmäher
 RU Электрокосилка
 CZ Elektrická sekačka
 HU Elektromos fűnyíró-gép
 RO Cositoare electrica pt. iarba
 FR Tondeuse à gazon électrique
 IT Rasaerba elettrico
 ES Contracesped
 CN 电动草坪机



230V~
50/60Hz

1800 W

3300 min⁻¹

380 mm

60 / 70 / 40 / 50 / 20 / 30 mm

50 L

160 mm / 200 mm

$L_{PA} = 82,8 \pm 3,0$ dB; $L_{WA} = 93,7 \pm 2,4$ dB; $a_n = 3,15 \pm 1,5$ m/s²

YATO	[W]	
YT-85205	1800	1

EN Electric lawn mower
PL Kosiarka elektryczna
DE Elektrischer grasmäher
RU Электросила
CZ Elektrická sekačka
HU Elektromos fűnyíró-gép
RO Cositoare electrica pt. iarba
FR Tondeuse à gazon électrique
IT Rasaerba elettrico
ES Contracesped
CN 电动草坪机



230V~ 50/60Hz	2000 W
3300 min ⁻¹	430 mm
60 70 40 50 20 30 mm	50 L
160 mm 240 mm	

$L_{pa} = 83,6 \pm 3,0$ dB; $L_{wa} = 94,6 \pm 1,8$ dB; $a_n = 3,45 \pm 1,5$ m/s²

YATO	[W]	
YT-85208	2000	1

EN Electric tiller
PL Glebogryzarka elektryczna
DE Elektro-Bodenhacke
RU Электрический культиватор
CZ Elektrický kultivátor
HU Elektromos kapálógép
RO Motoșapă electrică
FR Motobineuse électrique
IT Motozappa elettrico
ES Motoazada eléctrica
CN 松土机



230-240V~ 50Hz	1500 W
220 mm	450 mm
205 mm	

$L_{pa} = 80,4 \pm 3,0$ dB; $L_{wa} = 91,57 \pm 1,28$ dB; $a_n = 0,968 \pm 1,5 / 0,947 \pm 1,5$ m/s²

YATO	[W]	
YT-84850	1500	1

EN Electric scarifier
PL Wertykulator elektryczny
DE Elektrischer Vertikutierer
RU Электрический скарификатор
CZ Elektrický vertikutátor
HU Elektromos gyomeltávolító kefe
RO Scarificator electric
FR Scarificateur électrique
IT Spazzola elettrica
ES Escarificador eléctrico
CN 电动松土机

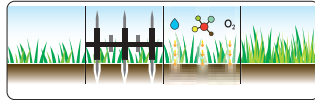

230-240V~ 50Hz	1800 W
3500 min ⁻¹	max 12mm ↓
380 mm	45 L
	INTERCHANGEABLE ROLLERS WYMIENNE WAŁKI
x16	x24

$L_{pa} = 90,2 \pm 3,0$ dB; $L_{wa} = 105,17 \pm 3,0$ dB; $a_n = 1,679 \pm 1,5$ m/s²

YATO	[W]	
YT-84840	1800	1

EN Electric weed sweeper
PL Elektryczna szczotka do chwastów
DE Elektrische Unkrautbürste
RU Электрическая щетка для сорняков
CZ Elektrický kartáč k odstraňování plevelu
HU Elektromos gyomeltávolító kefe
RO Matura electrica pt. buruieni
FR Brosse de désherbage électrique
IT Spazzola elettrica per erbacce
ES Cepillo eléctrico para malas hierbas
CN 电动杂草清洁剂



230-240V~ 50Hz	400 W
1800 min ⁻¹	110 mm
SOFT GRIP MIEKKI UCHWYT	TELESCOPIC HANDLE UCHWYT TELESKOPOWY
ADJUSTABLE ADDITIONAL HANDLE REGULOWANY UCHWYT DODATKOWY	

$L_{pa} = 83,0 \pm 3,0$ dB; $L_{wa} = 91,0 \pm 3,0$ dB; $a_n = 2,2 \pm 1,5$ m/s²

YATO	[W]	
YT-85800	400	6

EN Electric multi-brush
PL Szczotka elektryczna
DE Elektrische Bürste
RU Электрическая щетка
CZ Elektrický kartáč
HU Elektromos kefe
RO Perie electrica
FR Brosse rotative électrique
IT Spazzola elettrica
ES Cepillo eléctrico
CN 电动多功能刷



230-240V~ 50Hz	500 W
750-1300 min ⁻¹	100 mm
SOFT GRIP MIEKKI UCHWYT	TELESCOPIC HANDLE UCHWYT TELESKOPOWY
ADJUSTABLE ADDITIONAL HANDLE REGULOWANY UCHWYT DODATKOWY	

$L_{pa} = 83,7 \pm 3,0$ dB; $L_{wa} = 94,7 \pm 3,0$ dB; $a_n = 3,39 \pm 1,5$ m/s²

YATO	[W]	
YT-85803	500	2

EN Leaf vacuum / blower
PL Odkurzacz / dmuchawa do liści
DE Laubsauger / Laubbläser
RU Воздуходувка-пылесос
CZ Vysavač / odfukovač listí
HU Lombszívó / lombfúvó
RO Sulfanta / aspirator
FR Aspirateur-souffleur de feuilles
IT Aspiratore / soffiatore per foglie
ES Aspiradora / soplador de hojas
CN 电动吹吸机



3 in 1 3 w 1	230-240V~ 50Hz
3000 W	11500-15500 min ⁻¹
10-16 m ³ /min	100-300 km/h
45 L	15:1

- Vacuuming
- Blowing
- Shredding
- Odkurzanie
- Dmuchanie
- Rozdrabnianie

$L_{pa} = 90,8 \pm 3,0$ dB; $L_{wa} = 102,3 \pm 2,1$ dB; $a_n = 2,702 \pm 1,5$ m/s²

YATO	[W]	
YT-85182	3000	1

EN Leaf vacuum / blower
 PL Odkurzacz / dmuchawa do liści
 DE Laubsauger / Laubbläser
 RU Водуходука-пылесос
 CZ Vysavač / odfukovač listí
 HU Lombszívó / lombfúvó
 RO Sufianta / aspirator
 FR Aspirateur-souffleur de feuilles
 IT Aspiratore / soffiatore per foglie
 ES Aspiradora / soplador de hojas
 CN 电动吹吸机

- Vacuuming
- Blowing
- Shredding
- Odkurzanie
- Dmuchanie
- Rozdrabnianie



3 in 1
 3 w 1
 220-240V~
 50Hz
 3500 W
 9000-15000 min⁻¹
 13.2 m³/min
 270 km/h
 35 L

$L_{pA} = 90,2 \pm 3,0$ dB; $L_{wA} = 102,4 \pm 3,0$ dB; $a_n = 4,27 \pm 1,5$ m/s²

YATO	[W]	
YT-85180	3500	1

EN Gasoline backpack sprayer
 PL Opryskiwacz plecakowy spalinowy
 DE Benzin Motorsprüher
 RU Опрыскиватель бензиновый
 CZ Motorový rosič
 HU Benzines permetező
 RO Pulverizatoare pe benzina
 FR Pulvérisateur à essence
 IT Pompa irroratrice a spalla a motore
 ES Pulverizador de gasolina
 CN 汽油喷雾器

2.13 kW
 2.9 KM
 41.5 cm³
 20 L
 17 m³/min
 12 m



$L_{pA} = 99,0 \pm 3,0$ dB; $L_{wA} = 111,0 \pm 3,0$ dB; $a_n = 0,8 \pm 1,5 / 0,9 \pm 1,5$ m/s²

YATO	[kW]	[KM]	
YT-86240	2.13	2.9	1

EN Soil drill bit
 PL Wierćta glebowe
 DE Erdbohrer
 RU Шнек для бензобура
 CZ Půdní vrták
 HU Talajfúró szár
 RO Burghiu pt. pamant
 FR Foret pour tarière
 IT Punta per trivella
 ES Broca ahoyadora
 CN 地钻钻头



YATO	Ø [mm]	L [mm]	
YT-84670	100	785	1
YT-84671	150	785	1
YT-84672	200	785	1

EN Blade for lawn mower
 PL Ostrze do kosiarki
 DE Mähmesser
 RU Нож для косилки
 CZ Nůž do sekačky
 HU Fűnyíró kés
 RO Lama pt. masina tuns iarba
 FR Lame de tondeuse
 IT Lama per tosaerba
 ES Cuchillas de segadoras
 CN 电动割草机刀片

5.5 mm
 9.5 mm

320 mm
 For YT-85200
 Dla YT-85200



YATO	L [mm]	
YT-85160	320	80

380 mm
 For YT-85205
 Dla YT-85205



YATO	L [mm]	
YT-85161	380	50

430 mm
 For YT-85208
 Dla YT-85208



YATO	L [mm]	
YT-85162	430	50

EN Gasoline earth auger
 PL Wiertnica spalinowa
 DE Benzin Erdlochbohrer
 RU Бензобур
 CZ Zemní vrtací stroj benzínový
 HU Benzines talajfúró
 RO Motoburghiu de pamant
 FR Tarière à moteur
 IT Mototrivella a scoppio
 ES Ahoyadora
 CN 地钻

- Tool-free drill exchange
- Balanced and easy to operate
- Beznarzędziowa wymiana wiertel
- Dobrze wyważona i łatwa w obsłudze



1.4 kW

51.2 cm³

320 min⁻¹ (max.)

40 : 1

ANTI-VIBRATION SYSTEM SYSTEM ANTIVIBRACIUNY

50 cm

100 mm

150 mm

200 mm



$L_{pA} = 103,8 \pm 3,00$ dB; $L_{wA} = 107,54 \pm 3,00$ dB; $a_n = 12,469 \pm 1,5$ m/s²

YATO	[kW]	[KM]	
YT-84660	1.4	1.9	1

EN Soil drill bit extension
 PL Przedłużka do wiertła glebowego
 DE Verlängerung für Erdbohrer
 RU Удлинитель шнека для бензобура
 CZ Nástavec pro půdní vrták
 HU Talajfúró szár hosszabbító
 RO Extensie burghiu pt. pamant
 FR Extension pour foret de sol
 IT Prolunga per trivella per terreno
 ES Extensión de broca ahoyadora
 CN 接杆

500 mm



YATO	L [mm]	
YT-84675	500	20

EN Gasoline chainsaw
PL Piłarka spalinowa
DE Motorsäge
RU Бензопила
CZ Motorová pila
HU Benzin láncfűrész
RO Drujba pe benzina
FR Tronçonneuse
IT Motosega a benzina
ES Motosierra de gasolina
CN 油锯



0.75 kW	1.0 KM	25.4 cm ²	8500 min ⁻¹	12" 30 cm	38 9.52 mm
45	0.05 1.3 mm	AUTOMATIC OIL LUBRICATION SYSTEM AUTOMATISCHES SCHMARENANNE (UKLADAO TRACESKO)		0.2 L	40 : 1

$L_{PA} = 95.4 \pm 3.0$ dB; $L_{WA} = 108.4 \pm 3.0$ dB; $a_h = 7.199 \pm 1.5 / 7.492 \pm 1.5$ m/s²

YATO	[kW]	[KM]	L [mm]	
YT-84893	0.75	1	300	2

EN Gasoline chainsaw
PL Piłarka spalinowa
DE Motorsäge
RU Бензопила
CZ Motorová pila
HU Benzin láncfűrész
RO Drujba pe benzina
FR Tronçonneuse
IT Motosega a benzina
ES Motosierra de gasolina
CN 油锯



1.3 kW	1.7 KM	37.2 cm ²	8000 min ⁻¹	14" 36 cm	38 9.52 mm
0.05 1.3 mm	ANTI-VIBRATION SYSTEM SYSTEM ANTI-VIBRACYJNY		0.17 L	40 : 1	

$L_{PA} = 93.35 \pm 1.08$ dB; $L_{WA} = 112.33 \pm 1.08$ dB; $a_h = 5.600 \pm 1.5 / 4.884 \pm 1.5$ m/s²

YATO	[kW]	[KM]	L [mm]	
YT-84895	1.3	1.7	330	1

EN Gasoline chainsaw
PL Piłarka spalinowa
DE Motorsäge
RU Бензопила
CZ Motorová pila
HU Benzin láncfűrész
RO Drujba pe benzina
FR Tronçonneuse
IT Motosega a benzina
ES Motosierra de gasolina
CN 油锯



1.8 kW	2.4 KM	45.1 cm ²	8500 min ⁻¹	16" 40 cm	38 9.52 mm
0.05 1.3 mm	ANTI-VIBRATION SYSTEM SYSTEM ANTI-VIBRACYJNY		0.24 L	40 : 1	

$L_{PA} = 89.69 \pm 1.37$ dB; $L_{WA} = 109.19 \pm 1.37$ dB; $a_h = 5.650 \pm 1.5 / 6.027 \pm 1.5$ m/s²

YATO	[kW]	[KM]	L [mm]	
YT-84901	1.8	2.4	360	1

EN Gasoline chainsaw
PL Piłarka spalinowa
DE Motorsäge
RU Бензопила
CZ Motorová pila
HU Benzin láncfűrész
RO Drujba pe benzina
FR Tronçonneuse
IT Motosega a benzina
ES Motosierra de gasolina
CN 油锯



2.5 kW	3.4 KM	56.5 cm ²	8500 min ⁻¹	20" 50 cm	38 9.52 mm
0.05 1.3 mm	ANTI-VIBRATION SYSTEM SYSTEM ANTI-VIBRACYJNY		0.24 L	40 : 1	

$L_{PA} = 94.59 \pm 1.34$ dB; $L_{WA} = 113.46 \pm 1.34$ dB; $a_h = 7.234 \pm 1.5 / 9.528 \pm 1.5$ m/s²

YATO	[kW]	[KM]	L [mm]	
YT-84910	2.5	3.4	480	1

EN Brushcutter
PL Kosa spalinowa
DE Motorsense
RU Бензокоса
CZ Motorový křovinořez
HU Motoros fűkasza
RO Motocoasa
FR Débroussailluse
IT Decespugliatore a benzina
ES Motoguadaña de gasolina
CN 割草机



1.25 kW	1.7 KM	42.7 cm ²	430 mm	0.85 L	255x25.4 mm	40 : 1	EASY START LATWY ROZRUCH	EASY TRANSPORT LATWY TRANSPORT
---------	--------	----------------------	--------	--------	-------------	--------	--------------------------	--------------------------------

$L_{PA} = 96.3 \pm 3.0$ dB; $L_{WA} = 110.3 \pm 3.0$ dB; $a_h = 3.992 \pm 1.5 / 10.403 \pm 1.5$ m/s²

YATO	[kW]	[KM]	
YT-85003	1.25	1.7	1

EN Gasoline tiller
PL Glebogryzarka spalinowa
DE Benzin-Bodenhacke
RU Бензиновый культиватор
CZ Motorový kultivátor
HU Benzines kapálógép
RO Motosapă pe benzina
FR Motobineuse avec moteur à combustion
IT Motozappa a benzina
ES Motoazada gasolina
CN 汽油旋耕机



3.6 kW	173 cm ²	170 mm	600 mm	x6 BLADES OSTRZA	270 mm	150 mm	1.5 L	0.6 L
--------	---------------------	--------	--------	------------------	--------	--------	-------	-------

$L_{PA} = 77.9 \pm 0.199$ dB; $L_{WA} = 92.58 \pm 0.199$ dB; $a_h = 3.10 \pm 1.5 / 3.02 \pm 1.5$ m/s²

YATO	[kW]	[KM]	
YT-84860	3.6	4.08	1

EN Trimmer head
 PL Glowica żyłkowa
 DE Trimmerkopf
 RU Головка с леской
 CZ Strunová hlava
 HU Damil fej
 RO Cap cu cablu
 FR Tête de coupe
 IT Testina di taglio a filo
 ES Cabezal de hilo
 CN 铝制打草头

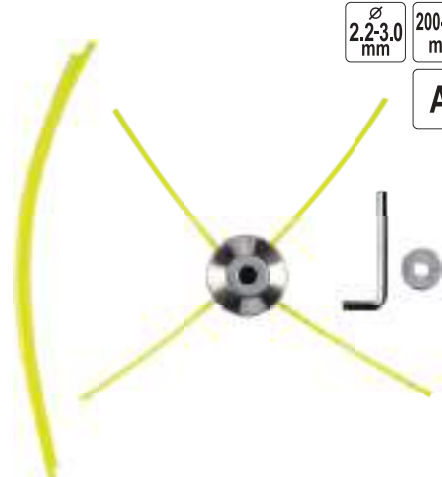

∅ 2.2-3.0 mm
 200-430 mm
 30 ≤ cm²
 AI 

For YT-85001, YT-85003, YT-85010
 Dla YT-85001, YT-85003, YT-85010

YATO  
 YT-85111 25/50

EN Trimmer head
 PL Glowica żyłkowa
 DE Trimmerkopf
 RU Головка с леской
 CZ Strunová hlava
 HU Damil fej
 RO Cap cu cablu
 FR Tête de coupe
 IT Testina di taglio a filo
 ES Cabezal de hilo
 CN 铝制打草头



∅ 2.2-3.0 mm
 30 ≤ cm²
 M12x1.75L x4 ADAPTER 

For YT-85001, YT-85003, YT-85010
 Dla YT-85001, YT-85003, YT-85010

YATO  
 YT-85121 32

EN Trimmer head
 PL Glowica żyłkowa
 DE Trimmerkopf
 RU Головка с леской
 CZ Strunová hlava
 HU Damil fej
 RO Cap cu cablu
 FR Tête de coupe
 IT Testina di taglio a filo
 ES Cabezal de hilo
 CN 铝制打草头

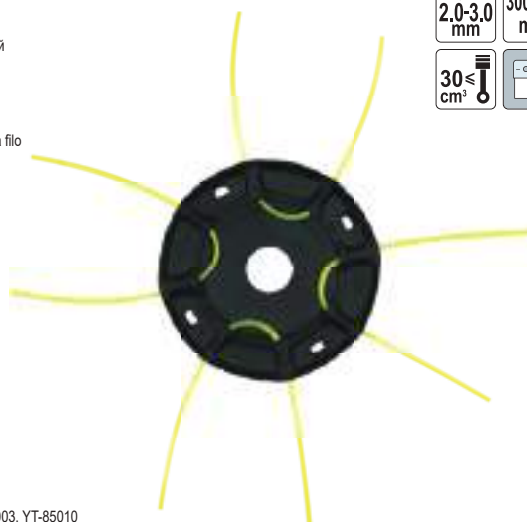



∅ 2.0-3.0 mm
 300-430 mm
 30 ≤ cm² 

For YT-85001, YT-85003, YT-85010
 Dla YT-85001, YT-85003, YT-85010

YATO  
 YT-85135 25/100

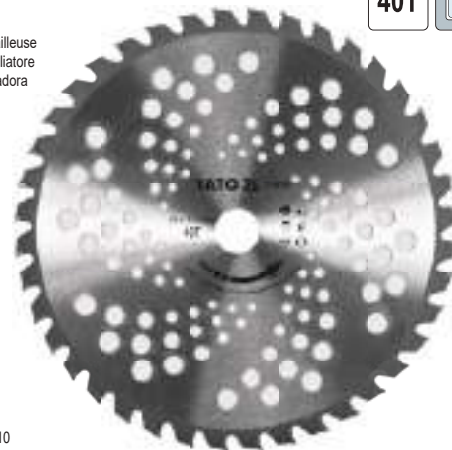
EN TCT blade for brushcutters
 PL Tarcza tnąca do kosy spalinowej
 DE Sägeblatt für Motorsensen
 RU Режущий диск для косы
 CZ Pílový kotouč do křovinořezy
 HU Fűkasza vágókorong
 RO Disc pt. motocoasa
 FR Lame disque pour débroussaileuse
 IT Disco da taglio per decespugliatore
 ES Disco de corte para desbrozadora
 CN 多孔割草片



∅ 255x25.4 mm
 30 ≤ cm²
 40T 

For YT-85001, YT-85003, YT-85010
 Dla YT-85001, YT-85003, YT-85010

YATO  
 YT-85150 20/40

EN 3-tooth brushcutter blade
 PL Tarcza tnąca trójzębna
 DE 3-Zahn Dickichtmesser
 RU Нож трехлопастной
 CZ Žací nůž 3-zubý
 HU 3 fogú vágókés
 RO Lama taiere cu 3 dinti pt. motocoasa
 FR Lame 3 dents pour débroussaileuse
 IT Disco per decespugliatore a 3 denti
 ES Cuchilla de 3 puntas para desbrozadora
 CN 三齿割草片



255x25.4 x1.6 mm
 30 ≤ cm² 



For YT-85001, YT-85003, YT-85010
 Dla YT-85001, YT-85003, YT-85010

YATO  
 YT-85155 25/50

EN Brushcutter wire brush
 PL Szczotka druciana do kosy
 DE Drahtbürste für Motorsense
 RU Щетка для мотокосы
 CZ Drátěný kartáč na křovinořez
 HU Drótketűtárcsa fűkaszához
 RO Perie circulară cu toroane
 FR Brosse métallique pour débroussaileuse
 IT Spazzola metallica per decespugliatore
 ES Cepillo de alambre para desbrozadora
 CN 除草盘



  
 STEEL WIRE
 DRUT
 STALOWY 

YATO 	∅ [mm]	∅d [mm]	max ∅ [min □]	
YT-85141	150	25.4	10000	30
YT-85142	200	25.4	10000	20

EN Guide bar
PL Prowadnica
DE Führungsschiene
RU Шина для пил
CZ Vodicí lišta na řetězové pile
HU Láncevezető

RO Lama de ghidaj
FR Guide de tronçonneuse
IT Barra per sega
ES Barra guía
CN 导板

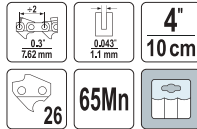

For YT-828135, YT-828136
Dla YT-828135, YT-828136

YATO	L	Links quantity / Liczba ogniw	For chainsaws / Do łańcuchów	
YT-84914	4" (100 mm)	26	YT-828135, YT-828136	250

EN Chainsaw guide bar
PL Prowadnica do pilarek
DE Führungsschiene für Kettensägen
RU Шина для бензопил
CZ Vodicí lišta k řetězové pile
HU Láncevezető

RO Lama pt. drijba
FR Guide de tronçonneuse
IT Barra per motosega
ES Barra guía motosierra
CN 导板

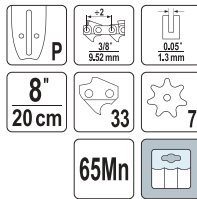

For YT-849479
Dla YT-849479

YATO	Mounting type / Rodzaj mocowania	L	Links quantity / Liczba ogniw	For chains / Do łańcuchów	
YT-84923	P	8" (200 mm)	33	YT-849479	20

EN Chainsaw guide bar
PL Prowadnica do pilarek
DE Führungsschiene für Kettensägen
RU Шина для бензопил
CZ Vodicí lišta k řetězové pile
HU Láncevezető

RO Lama pt. drijba
FR Guide de tronçonneuse
IT Barra per motosega
ES Barra guía motosierra
CN 导板

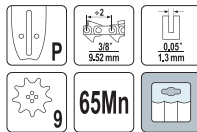

YATO	Mounting type / Rodzaj mocowania	L	Links quantity / Liczba ogniw	For chains / Do łańcuchów	For chainsaws / Do pilarek	
YT-84925	P	10" (250 mm)	40	YT-84948, YT-84960	-	20
YT-84927	P	12" (300 mm)	44	YT-84949, YT-849495, YT-85090, YT-828137, YT-84960	YT-828138	20
YT-84931	P	14" (360 mm)	52	YT-84951, YT-84960	YT-84985, 79675	20
YT-84935	P	16" (400 mm)	56	YT-84953, YT-84960	YT-84870	20
YT-849355	P	18" (450 mm)	62	YT-84956, YT-84960	-	20

EN Chainsaw guide bar
PL Prowadnica do pilarek
DE Führungsschiene für Kettensägen
RU Шина для бензопил
CZ Vodicí lišta k řetězové pile
HU Láncevezető

RO Lama pt. drijba
FR Guide de tronçonneuse
IT Barra per motosega
ES Barra guía motosierra
CN 导板

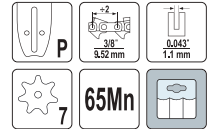

YATO	Mounting type / Rodzaj mocowania	L	Links quantity / Liczba ogniw	For chains / Do łańcuchów	For chainsaws / Do pilarek	
YT-84915	P	8" (200 mm)	33	YT-849470	-	20
YT-84916	P	10" (250 mm)	40	YT-849472	-	20
YT-84917	P	12" (300 mm)	45	YT-849474	-	20
YT-84918	P	14" (360 mm)	52	YT-849475	YT-82812, YT-82813	20
YT-84919	P	16" (400 mm)	56	YT-849477	-	20

EN Chainsaw guide bar
PL Prowadnica do pilarek
DE Führungsschiene für Kettensägen
RU Шина для бензопил
CZ Vodicí lišta k řetězové pile
HU Láncevezető

RO Lama pt. drijba
FR Guide de tronçonneuse
IT Barra per motosega
ES Barra guía motosierra
CN 导板

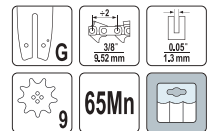

YATO	Mounting type / Rodzaj mocowania	L	Links quantity / Liczba ogniw	For chains / Do łańcuchów	
YT-849299	G	12" (300 mm)	44	YT-84949	20
YT-84930	G	14" (360 mm)	50	YT-84950, YT-84960	20
YT-849301	G	16" (400 mm)	55	YT-849529	20

EN Chainsaw guide bar
PL Prowadnica do pilarek
DE Führungsschiene für Kettensägen
RU Шина для бензопил
CZ Vodicí lišta k řetězové pile
HU Láncevezető

RO Lama pt. drijba
FR Guide de tronçonneuse
IT Barra per motosega
ES Barra guía motosierra
CN 导板

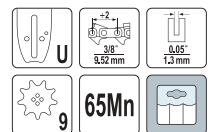

YATO	Mounting type / Rodzaj mocowania	L	Links quantity / Liczba ogniw	For chains / Do łańcuchów	
YT-849381	U	12" (300 mm)	45	YT-849495	20
YT-849382	U	14" (360 mm)	52	YT-84951	20
YT-849383	U	16" (400 mm)	56	YT-84953, YT-84954	20

EN Chainsaw guide bar
 PL Prowadnica do pilarek
 DE Führungsschiene für Kettensägen
 RU Шина для бензопил
 CZ Vodicí lišta k řetězové pile
 HU Lánvezető

RO Lama pt. drijba
 FR Guide de tronçonneuse
 IT Barra per motosega
 ES Barra guía motosierra
 CN 导板

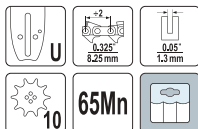

EN Chainsaw guide bar
 PL Prowadnica do pilarek
 DE Führungsschiene für Kettensägen
 RU Шина для бензопил
 CZ Vodicí lišta k řetězové pile
 HU Lánvezető

RO Lama pt. drijba
 FR Guide de tronçonneuse
 IT Barra per motosega
 ES Barra guía motosierra
 CN 导板

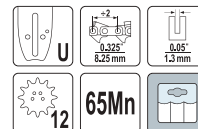

YATO	Mounting type / Rodzaj mocowania	L	Links quantity / Liczba ogniw	For chains / Do łańcuchów	For chainsaws / Do pilarek	
YT-849329	U	13" (330 mm)	56	YT-849449	-	20
YT-849333	U	20" (500 mm)	78	YT-849453	YT-84905	20

YATO	Mounting type / Rodzaj mocowania	L	Links quantity / Liczba ogniw	For chains / Do łańcuchów	
YT-84933	U	15" (380 mm)	64	YT-84945, YT-84962	20
YT-849331	U	16" (400 mm)	66	YT-849451	20
YT-849332	U	18" (450 mm)	72	YT-849452	20

EN Chainsaw guide bar
 PL Prowadnica do pilarek
 DE Führungsschiene für Kettensägen
 RU Шина для бензопил
 CZ Vodicí lišta k řetězové pile
 HU Lánvezető

RO Lama pt. drijba
 FR Guide de tronçonneuse
 IT Barra per motosega
 ES Barra guía motosierra
 CN 导板

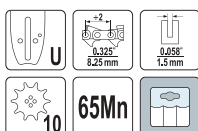

EN Chainsaw guide bar
 PL Prowadnica do pilarek
 DE Führungsschiene für Kettensägen
 RU Шина для бензопил
 CZ Vodicí lišta k řetězové pile
 HU Lánvezető

RO Lama pt. drijba
 FR Guide de tronçonneuse
 IT Barra per motosega
 ES Barra guía motosierra
 CN 导板

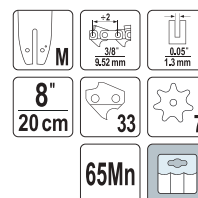

YATO	Mounting type / Rodzaj mocowania	L	Links quantity / Liczba ogniw	For chains / Do łańcuchów	
YT-84929	U	13" (330 mm)	56	YT-84940	20
YT-84938	U	20" (500 mm)	78	YT-849441	20

For YT-82836, YT-82837, YT-849479
 Dla YT-82836, YT-82837, YT-849479

YATO	L	Links quantity / Liczba ogniw	
YT-84921	8" (200 mm)	33	20

EN Chainsaw guide bar
 PL Prowadnica do pilarek
 DE Führungsschiene für Kettensägen
 RU Шина для бензопил
 CZ Vodicí lišta k řetězové pile
 HU Lánvezető

RO Lama pt. drijba
 FR Guide de tronçonneuse
 IT Barra per motosega
 ES Barra guía motosierra
 CN 导板

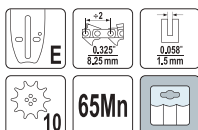

EN Chainsaw guide bar
 PL Prowadnica do pilarek
 DE Führungsschiene für Kettensägen
 RU Шина для бензопил
 CZ Vodicí lišta k řetězové pile
 HU Lánvezető

RO Lama pt. drijba
 FR Guide de tronçonneuse
 IT Barra per motosega
 ES Barra guía motosierra
 CN 导板

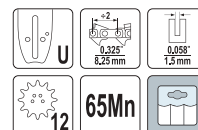

YATO	Mounting type / Rodzaj mocowania	L	Links quantity / Liczba ogniw	For chains / Do łańcuchów	
YT-84928	E	12" (300 mm)	50	YT-849395, YT-84963	20
YT-849311	E	14" (360 mm)	60	YT-849405, YT-84963	20

YATO	Mounting type / Rodzaj mocowania	L	Links quantity / Liczba ogniw	For chains / Do łańcuchów	For chainsaws / Do pilarek	
YT-84934	U	15" (380 mm)	64	YT-84941, YT-84963	-	20
YT-849351	U	16" (400 mm)	66	YT-84942, YT-84963	-	20
YT-84936	U	18" (450 mm)	72	YT-84943, YT-84963	YT-84900	20
YT-84937	U	20" (500 mm)	76	YT-84944, YT-84963	YT-84910	20



- EN Chain regulating plate
PL Płytką regulująca naciąg łańcucha
DE Einstellplatte für Kettenspannung
RU Пластина натяжитель цепи
CZ Destička pro nastavení napnutí řetězu
HU Láncfeszesség szabályozó lemez
RO Placă de reglare a lanțului
FR Plaque de réglage de la tension de la chaîne
IT Piastra tendicatena
ES Placa reguladora del apriete de cadena
CN 链条张力调节片



For guide bars A041/P
Do prowadnic A041/P

- EN Chain for chainsaw
PL Łańcuch tnący do pilarek
DE Kette für Kettensägen
RU Цепь для бензопилы
CZ Řetěz pro řetězové pily
HU Lánc láncfűrész

- RO Lant pt. drijba
FR Chaîne de tronçonneuse
IT Catena motosega
ES Cadena de motosierra
CN 链条



YATO	L	Links quantity / Liczba ogniw	For guide bars / Do prowadnic	For chainsaws / Do pilarek	
YT-849470	8" (200 mm)	33	YT-84915	-	50
YT-849472	10" (250 mm)	40	YT-84916	-	50
YT-849474	12" (300 mm)	45	YT-84917	-	50
YT-849475	14" (360 mm)	52	YT-84918	YT-82812, YT-82813	50
YT-849477	16" (400 mm)	56	YT-84919	-	50

- EN Chain for chainsaw
PL Łańcuch tnący do pilarek
DE Kette für Kettensägen
RU Цепь для бензопилы
CZ Řetěz pro řetězové pily
HU Lánc láncfűrész

- RO Lant pt. drijba
FR Chaîne de tronçonneuse
IT Catena motosega
ES Cadena de motosierra
CN 链条

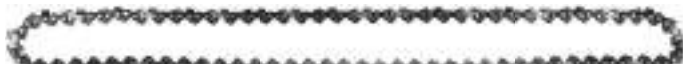
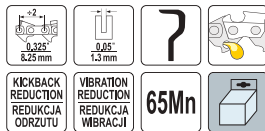

YATO	L	Links quantity / Liczba ogniw	For guide bars / Do prowadnic	For chainsaws / Do pilarek	
YT-849449	13" (330 mm)	56	YT-849329	-	50
YT-84945	15" (380 mm)	64	YT-84933	-	50
YT-849451	16" (400 mm)	66	YT-849331	-	50
YT-849452	18" (450 mm)	72	YT-849332	-	50
YT-849453	20" (500 mm)	78	YT-849333	YT-84905	50

YATO	
YT-84939	400

- EN Chain for chainsaw
PL Łańcuch tnący do pilarek
DE Kette für Kettensägen
RU Цепь для бензопилы
CZ Řetěz pro řetězové pily
HU Lánc láncfűrész

- RO Lant pt. drijba
FR Chaîne de tronçonneuse
IT Catena motosega
ES Cadena de motosierra
CN 链条



YATO	L	Links quantity / Liczba ogniw	For guide bars / Do prowadnic	For chainsaws / Do pilarek	
YT-849479	8" (200 mm)	33	YT-84921, YT-84923	YT-82836, YT-82837	50
YT-84948	10" (250 mm)	40	YT-84925	-	50
YT-84949	12" (300 mm)	44	YT-849299, YT-84927	-	50
YT-849495	12" (300 mm)	45	YT-849381, YT-849299, YT-84927	YT-84893, YT- 828137, YT-828138	50
YT-84950	14" (360 mm)	50	YT-84930	-	50
YT-84951	14" (360 mm)	52	YT-84931, YT-849382	YT-84868, YT-84895, 79675	50
YT-849529	16" (400 mm)	55	YT-849301	-	50
YT-84953	16" (400 mm)	56	YT-84935, YT-849383	YT-84870, YT-84871, YT-84872	50
YT-84954	16" (400 mm)	57	YT-849383	-	50
YT-84956	18" (450 mm)	62	YT-849355	-	50

- EN Chain for chainsaw
PL Łańcuch tnący do pilarek
DE Kette für Kettensägen
RU Цепь для бензопилы
CZ Řetěz pro řetězové pily
HU Lánc láncfűrész

- RO Lant pt. drijba
FR Chaîne de tronçonneuse
IT Catena motosega
ES Cadena de motosierra
CN 链条



YATO	L	Links quantity / Liczba ogniw	For guide bars / Do prowadnic	For chainsaws / Do pilarek	
YT-849395	12" (300 mm)	50	YT-84928	-	50
YT-84940	13" (330 mm)	56	YT-84929	-	50
YT-849405	14" (360 mm)	60	YT-849311	-	50
YT-84941	15" (380 mm)	64	YT-84934	-	50
YT-84942	16" (400 mm)	66	YT-849351	-	50
YT-84943	18" (450 mm)	72	YT-84936	YT-84900	50
YT-84944	20" (500 mm)	76	YT-84937	YT-84910	50
YT-849441	20" (500 mm)	78	YT-84938	-	50

EN Chain for chainsaw
 PL Łańcuch tnący do pilarek
 DE Kette für Kettensägen
 RU Цепь для бензопилы
 CZ Řetěz pro řetězové pily
 HU Láncláncfűrész
 RO Lant pt. drujba
 FR Chaîne de tronçonneuse
 IT Catena motosega
 ES Cadena de motosierra
 CN 链条卷



3/8\"/>3.2 mm	0.043\"/>1.1 mm	1632	65Mn	KICKBACK REDUCTION REDUKCJA ODRZUTU
VIBRATION REDUCTION REDUKCJA WIBRACJI				

For YT-82812, YT-82813
 Dla YT-82812, YT-82813

YATO	Links quantity / Liczba ogniw	
YT-84959	1632	1

EN Chain for chainsaw
 PL Łańcuch tnący do pilarek
 DE Kette für Kettensägen
 RU Цепь для бензопилы
 CZ Řetěz pro řetězové pily
 HU Láncláncfűrész
 RO Lant pt. drujba
 FR Chaîne de tronçonneuse
 IT Catena motosega
 ES Cadena de motosierra
 CN 链条卷



3/8\"/>3.2 mm	0.05\"/>1.3 mm	1632	KICKBACK REDUCTION REDUKCJA ODRZUTU
VIBRATION REDUCTION REDUKCJA WIBRACJI			
65Mn			
+30 PCS SPARE LINKS OSOBNA ZAPASOWE			

For YT-84930, YT-84931, YT-84935
 Dla YT-84930, YT-84931, YT-84935

Alpina, Dolmar, Husqvarna, McCulloch, Oleo-Mac, Partner

EN Chain for chainsaw
 PL Łańcuch tnący do pilarek
 DE Kette für Kettensägen
 RU Цепь для бензопилы
 CZ Řetěz pro řetězové pily
 HU Láncláncfűrész
 RO Lant pt. drujba
 FR Chaîne de tronçonneuse
 IT Catena motosega
 ES Cadena de motosierra
 CN 链条卷



3/8\"/>3.2 mm	0.05\"/>1.3 mm	1632	KICKBACK REDUCTION REDUKCJA ODRZUTU
VIBRATION REDUCTION REDUKCJA WIBRACJI			
65Mn			
+30 PCS SPARE LINKS OSOBNA ZAPASOWE			

For YT-84932
 Dla YT-84933

Alpina, Dolmar, Echo, Husqvarna, Jonsered, Makita, Oleo-Mac, Partner

YATO	Links quantity / Liczba ogniw	
YT-84960	1632	1

YATO	Links quantity / Liczba ogniw	
YT-84961	1632	1

EN Chain for chainsaw
 PL Łańcuch tnący do pilarek
 DE Kette für Kettensägen
 RU Цепь для бензопилы
 CZ Řetěz pro řetězové pily
 HU Láncláncfűrész
 RO Lant pt. drujba
 FR Chaîne de tronçonneuse
 IT Catena motosega
 ES Cadena de motosierra
 CN 链条卷



3/8\"/>3.2 mm	0.05\"/>1.3 mm	1846	KICKBACK REDUCTION REDUKCJA ODRZUTU
VIBRATION REDUCTION REDUKCJA WIBRACJI			
65Mn			
+30 PCS SPARE LINKS OSOBNA ZAPASOWE			

For YT-84905, YT-84933
 Dla YT-84905, YT-84933

Dolmar, Husqvarna, Jonsered, Makita, Oleo-Mac, Partner

EN Chain for chainsaw
 PL Łańcuch tnący do pilarek
 DE Kette für Kettensägen
 RU Цепь для бензопилы
 CZ Řetěz pro řetězové pily
 HU Láncláncfűrész
 RO Lant pt. drujba
 FR Chaîne de tronçonneuse
 IT Catena motosega
 ES Cadena de motosierra
 CN 链条卷



3/8\"/>3.2 mm	0.05\"/>1.3 mm	1846	KICKBACK REDUCTION REDUKCJA ODRZUTU
VIBRATION REDUCTION REDUKCJA WIBRACJI			
65Mn			
+30 PCS SPARE LINKS OSOBNA ZAPASOWE			

For YT-84900, YT-84934, YT-84936
 Dla YT-84900, YT-84934, YT-84936

Dolmar, Husqvarna, Jonsered, Makita, NAC, Oleo-Mac, Partner

YATO	Links quantity / Liczba ogniw	
YT-84962	1846	1

YATO	Links quantity / Liczba ogniw	
YT-84963	1846	1

EN Spare link for chainsaw
 PL Zestaw ogniw do łańcucha do pili
 DE Ersatzglied für Kettensäge
 RU Запасная цепь
 CZ Náhradní řetězový řetěz
 HU Csere lánc

RO Nituri lant drujba
 FR Lien de rechange pour tronçonneuse
 IT Set di maglie di catena
 ES Repuesto para sierra de cadena
 CN 连接片



5 PCS	65Mn	
-------	------	--

3/8\"/>3.2 mm	0.05\"/>1.3 mm

For YT-84940, YT-84941, YT-84942, YT-84943, YT-84944, YT-84963
 Dla YT-84940, YT-84941, YT-84942, YT-84943, YT-84944, YT-84963

3/8\"/>3.2 mm	0.05\"/>1.3 mm

For YT-84945, YT-84962
 Dla YT-84945, YT-84962

3/8\"/>3.2 mm	0.05\"/>1.3 mm

For YT-84950, YT-84951, YT-84953, YT-84954, YT-84960
 Dla YT-84950, YT-84951, YT-84953, YT-84954, YT-84960

3/8\"/>3.2 mm	0.05\"/>1.3 mm

For YT-84955
 Dla YT-84955

YATO	
YT-84975	120

YATO	
YT-84976	100

YATO	
YT-84977	100

YATO	
YT-84978	100

EN Chainsaw chain spinner
PL Nitownica do łańcuchów do pilarek
DE Sägeketten-Vornietgerät
RU Станок для клепания цепей
CZ Nýtovačka pilových řetězů
HU Szegecselő készülék fűrészlánchoz

RO Masina de nituit lanturi si de spart lanturi
FR Riveteuse d'établi pour chaines de tronçonneuses
IT Imbutitore per motoseghe
ES Remachadora banco cadenas de motosierra
CN 接链器

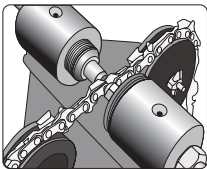
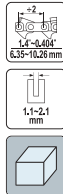

YATO
YT-84970



4

EN Chain sharpener
PL Ostrzałka do łańcuchów
DE Kettenschärfgerät
RU Заточка для цепей
CZ Bruska řetězů
HU Lánccélező
RO Masina ascutit lant drijba
FR Affûteuse de chaîne
IT Affilatrice per catene
ES Afilador para cadenas
CN 电动磨链机

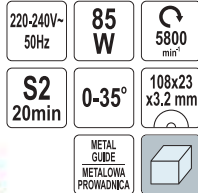

EN Replacement wheel for chainsaw sharpening tool
PL Kamień do ostrzałki łańcuchów
DE Schleifscheibe für Kettenschärfgerät
RU Камень для заточки цепей
CZ Kámen do brusky pilových řetězů
HU Lánccélező kő
RO Roata schimb pt. aparat ascutit lant drijba
FR Pierre à aiguiser les chaînes
IT Mola affilacatene
ES Sierra para afiladora de cadenas
CN 磨轮



For YT-84990
Dia YT-84990

YATO
YT-84991



100



YATO
YT-84990



4

- EN Flat depth-gauge file
- PL Piłnik płaski do szlifowania ograniczników głębokości
- DE Flachfeile zum Schleifen von Tiefenanschlägen
- RU Плоский напильник для шлифования ограничителей глубины
- CZ Plochý pilník k broušení hloubkových dorazů
- HU Lapos reszelő mélységhatárolók csiszolásához
- RO Pila plata pt. ascuțit dinti lant drujba
- FR Lime plate pour jauge de profondeur de ponçage
- IT Lima piatta per affilatura di fermi di profondità
- ES Lima plana para esmerilar topes de profundidad
- CN 扁锉



250 mm 15x2 mm BEARING STEEL STAL ŁOŻYSKOWA

PP

YATO	L [mm]	
YT-85022	250	200

- EN Round chain saw file set
- PL Zestaw pilników okrągłych do ostrzenia łańcuchów
- DE Rundfeileinsatz zum schärfen von Ketten
- RU Набор круглых напильников для заточки цепей
- CZ Sada kulatých pilníků k ostření řetězů
- HU Kerek reszelőkészlet láncélezéshez
- RO Set pile rotunde pt. lant drujba
- FR Limes rondes pour affûtage de chaînes
- IT Kit di lime tonde per affilatura catene
- ES Juego de limas redondas para afilar cadenas
- CN 链锯锉



3 PCS 250 mm BEARING STEEL STAL ŁOŻYSKOWA

PP

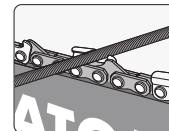

YATO	Ø [mm]	For / Dla	
YT-85025	4.0	3/8"	4/200
YT-85026	4.5	3/8", 0.325"	4/200
YT-85027	4.8	0.325"	4/200

- EN Chain saw file with guide
- PL Prowadnik z pilnikiem do ostrzenia łańcuchów
- DE Führungsschiene mit Kettenschärfefeile
- RU Направляющая с напильником для заточки цепей
- CZ Vodítko s pilníkem k ostření řetězů
- HU Vezető láncélező reszelővel
- RO Pila lant drujba cu ghidaj
- FR Guide avec lime pour affûtage de chaîne
- IT Guida con lima tonda per affilatura catene
- ES Guía con lima para afilar cadenas
- CN 链锯锉3件套



3 PCS 250 mm BEARING STEEL STAL ŁOŻYSKOWA

PP

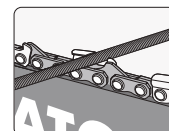

YATO	Ø [mm]	For / Dla	
YT-85030	4.0	3/8"	4/100
YT-85031	4.5	3/8", 0.325"	4/100
YT-85032	4.8	0.325"	4/100

- EN Chain saw file with guide
- PL Prowadnik z pilnikiem do ostrzenia łańcuchów
- DE Führungsschiene mit Kettenschärfefeile
- RU Направляющая с напильником для заточки цепей
- CZ Vodítko s pilníkem k ostření řetězů
- HU Vezető láncélező reszelővel
- RO Pila lant drujba cu ghidaj
- FR Guide avec lime pour affûtage de chaîne
- IT Guida con lima tonda per affilatura catene
- ES Guía con lima para afilar cadenas
- CN 链锯锉刀塑柄架



250 mm 30° 35° BEARING STEEL STAL ŁOŻYSKOWA

PP

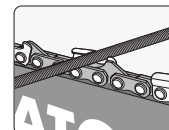

YATO	Ø [mm]	For / Dla	
YT-85035	4.0	3/8"	200
YT-85036	4.5	3/8", 0.325"	200
YT-85037	4.8	0.325"	200

- EN Chain sharpening set
- PL Zestaw do ostrzenia łańcucha
- DE Kettenschärfset
- RU Набор для заточки цепи
- CZ Sada k ostření řetězů
- HU Láncélező készlet
- RO Set ascuțit lant drujba
- FR Kit d'affûtage de chaîne
- IT Kit per affilatura catene
- ES Set para afilar cadenas
- CN 链锯锉刀布袋套装



4 PCS 25° 30° 35° BEARING STEEL STAL ŁOŻYSKOWA

PP

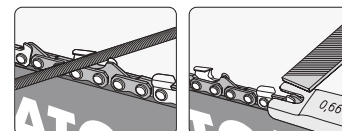

YATO	Ø [mm]	For / Dla	
YT-85040	4.0	3/8"	50
YT-85041	4.5	3/8", 0.325"	50
YT-85042	4.8	0.325"	50

EN Guide for depth-gauge
PL Przymiar do szlifowania ograniczników głębokości
DE Schleiflehre für Schleifen von Tiefenanschlägen
RU Измеритель для шлифования ограничителей глубины
CZ Měřítka k broušení hloubkových dorazů
HU Csiszolósablon mélység szabályozóhoz
RO Ghidaj pt. ascuțit dinti lant drijba
FR Jauge de profondeur de ponçage
IT Indicatore per affilatura di fermi di profondità
ES Medida para esmerilar topes de profundidad
CN 链条打磨深度尺

0.65 mm 10° 30° 35°



YATO	L [mm]	For / Dla	
YT-85051	150	YT-85022	200

EN Handle for round chain sharpening file
PL Rękojeść do pilnika okrągłego
DE Griff für Rundfeile
RU Ручка для круглого напильника
CZ Rukojeť do kulatého pilníku
HU Markolat kerek reszelőhöz
RO Maner pt. pila rotunda de ascuțit lant
FR Poignée de lime ronde
IT Impugnatura per lima tonda
ES Mango de lima redonda
CN 塑料手柄

PP



YATO	Ø [mm]	For / Dla	
YT-85060	4.0	3/8" / YT-85025	500
YT-85061	4.5	3/8", 0.325" / YT-85026	500
YT-85062	4.8	0.325" / YT-85027	500

YATO	Ø [mm]	For / Dla	
YT-85065	4.0	3/8" / YT-85025	200
YT-85066	4.5	3/8", 0.325" / YT-85026	200
YT-85067	4.8	0.325" / YT-85027	200

EN Logger filing vice
PL Imadło do mocowania prowadnicy
DE Schraubstock zur Befestigung der Führungsschiene
RU Тиски для крепления направляющей
CZ Svěrák k uchopení vodící lišty
HU Vezetőörgztető satu
RO Presa pt. nituit lant drijba
FR Étau pour maintenir le guide
IT Morsa per fissaggio della guida
ES Tornillo de banco para fijar la guía
CN 导板支架

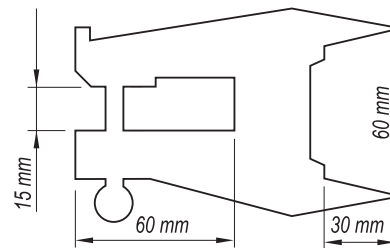

YATO	
YT-85075	2/60

ENERG **Y** **IA**
енергія · енерґія **IE** **IA**

YATO YT-99730

A++
A+
A
B
C
D
E
F
G

A

15,0 kW

ENERGIA · ЕНЕРГІЯ · ΕΝΕΡΓΕΙΑ · ENERGIA · ENERGY · ENERGIE · ENERGI

2015/1186

ENERG **Y** **IA**
енергія · енерґія **IE** **IA**

YATO YT-99733

A++
A+
A
B
C
D
E
F
G

A

30,0 kW

ENERGIA · ЕНЕРГІЯ · ΕΝΕΡΓΕΙΑ · ENERGIA · ENERGY · ENERGIE · ENERGI

2015/1186

ENERG **Y** **IA**
енергія · енерґія **IE** **IA**

YATO YT-99740

A++
A+
A
B
C
D
E
F
G

A

30,0 kW

ENERGIA · ЕНЕРГІЯ · ΕΝΕΡΓΕΙΑ · ENERGIA · ENERGY · ENERGIE · ENERGI

2015/1186

ENERG **Y** **IA**
енергія · енерґія **IE** **IA**

YATO YT-99743

A++
A+
A
B
C
D
E
F
G

A

50,0 kW

ENERGIA · ЕНЕРГІЯ · ΕΝΕΡΓΕΙΑ · ENERGIA · ENERGY · ENERGIE · ENERGI

2015/1186

19

Accessories Akcesoria



Tool belts
Pasy na narzędzia

560-561



Tool boxes
Skrzynki narzędziowe

564-570



Tool pockets
Kieszenie na narzędzia

561-562



Floor conveyors
Transport poziomy

571



Tool bags
Torby narzędziowe

562-564



Tool lanyards
Linki do narzędzi

571



EN Tool belt
 PL Pas narzędziowy
 DE Werkzeuggürtel
 RU Инструмент пояса
 CZ Opasek s nářadím
 HU Szerszám öv

RO Centura scule
 FR Ceinture à outils
 IT Cintura porta utensii
 ES Cinturón para herramientas
 CN 工具袋

600D
 POLYESTER
 POLYESTER



- Tool belt
- 4 large pockets
- 2 hammer holders
- 6 small pockets
- Pas narzędziowy
- 4 duże kieszenie
- 2 uchwyty na młotki
- 6 kieszonek

EN Tool belt
 PL Pas narzędziowy
 DE Werkzeuggürtel
 RU Инструмент пояса
 CZ Opasek s nářadím
 HU Szerszám öv

RO Centura scule
 FR Ceinture à outils
 IT Cintura porta utensii
 ES Cinturón para herramientas
 CN 工具袋

600D
 POLYESTER
 POLYESTER



- Tool belt
- 4 big patch pockets
- Measuring tape holder
- 10 small pockets
- Pas narzędziowy
- 4 duże nakładane kieszenie
- Uchwyt na taśmę mierniczą
- 10 kieszonek

YATO 
 YT-74001  10

YATO 
 YT-74002  10

EN Tooling belt with harness
 PL Pas narzędziowy na szelkach
 DE Werkzeuggürtel mit Hosenträger
 RU Инструментальный пояс с ляжками
 CZ Opasek na nářadí
 HU Szerszám öv

RO Curea port scule
 FR Ceinture à outils avec harnais
 IT Cintura portautensii con bretelle
 ES Cinturón para herramientas con arnés
 CN 背带式组合工具袋

600D
 POLYESTER
 POLYESTER

DETACHABLE
 HARNESS
 ODPINANA
 UPRZĄŻ



EN Tooling belt with harness
 PL Pas narzędziowy na szelkach
 DE Werkzeuggürtel mit Hosenträger
 RU Инструментальный пояс с ляжками
 CZ Opasek na nářadí
 HU Szerszám öv

RO Curea port scule
 FR Ceinture à outils avec harnais
 IT Cintura portautensii con bretelle
 ES Cinturón para herramientas con arnés
 CN 背带式组合工具袋

600D
 POLYESTER
 POLYESTER

DETACHABLE
 HARNESS
 ODPINANA
 UPRZĄŻ



- Harness
- Tool bags
- Hammer holder
- Nails pouch
- Szelki (uprząż)
- Sakwy
- Uchwyt na młotek
- Torba na gwoździe



- Harness
- Tool bag
- 2 drill holsters
- Hammer holder
- Nails pouch
- Szelki (uprząż)
- Sakwa
- 2 kabury na elektronarzędzia
- Uchwyt na młotek
- Torba na gwoździe

YATO 
 YT-74070  10

YATO 
 YT-74071  10

EN Heavy duty nail & tool pouch
PL Pas z kieszeniami na gwoździe i narzędzia
DE Werkzeuggürtel mit Nägelund Schraubentaschen
RU Ремень с сумками для гвоздей и инструментов

CZ Pás na nářadí pětkapový
HU Szeg és szerszámtartó öv
RO Centura port scule
FR Ceinture porte-outils clous

IT Cintura con le tasche per chiodi e utensili
ES Cinturón porta herramientas y accesorios varios
CN 重型工具袋

21
POCKETS
KIESZENIE

130
cm

HEAVY DUTY
NYLON
WZMOCNIONY
NYLON



YATO

YT-7400

10

EN Pouch belt
PL Pas na kieszenie na narzędzia
DE Gürtel für Werkzeugtaschen

RU Пояс для карманов для инструмента
CZ Opasek na monterské kapsáře
HU Öv erszényhez

RO Curea cu buzunar
FR Ceinture porte-outils
IT Cintura con le tasche porta utensili

ES Cinturón para bolsas de herramientas
CN 工具腰帶

90-120
cm

HEAVY DUTY
NYLON
WZMOCNIONY
NYLON



YATO

YT-7409

50/100

EN 8-pocket tool bag
PL 8-kieszeniowa torba na narzędzia
DE Gürtelwerkzeugtasche mit 8 Fächern
RU Сумка - 8 карманов для инструмента
CZ Kapsář na nářadí 8-kapový
HU Szerszámtartó erszény, 8 zsebbel
RO Geanta pt. scule 8 buzunare
FR Pochette à outils
IT Borsa porta attrezzi con 8 tasche
ES Bolso para herramientas de 8 bolsillos
CN 工具包

8
POCKETS
KIESZENIE

HEAVY DUTY
NYLON
WZMOCNIONY
NYLON



YATO

YT-7410

20/40

EN Universal cordless drill holder
PL Kieszeń na wiertarkę akumulatorową
DE Gürteltasche für Akkuschauber
RU Карман для аккумуляторной дрели
CZ Kapsář za opasek na akuvrtáčku
HU Univerzális tartóerszény akkus csavabehajtóhoz
RO Suport universal pt. bormasina
FR Pochette à perceuse sans-fil
IT Fondina per trapano a batteria
ES Bolsa porta taladradora de acumulador
CN 电钻通用挂袋

HEAVY DUTY
NYLON
WZMOCNIONY
NYLON



YATO

YT-7413

10/40

EN Tool pouch
PL Kabura na wkrętarke lub wiertarkę
DE Werkzeugbeutel
RU Инструмент мешок
CZ Opaskové pouzdro
HU Szerszám pisztolytáska
RO Suport masina de gaurit pt. centura
FR Pochette d'outil
IT Fondina per trapani a batteria
ES Herramientas de bolsillo
CN 电钻通用挂袋

600D
POLYESTER
POLYESTER



YATO

YT-7414

60

EN Universal cordless drill holder
PL Kieszeń na wiertarkę akumulatorową
DE Gürteltasche für Akkuschauber
RU Карман для аккумуляторной дрели
CZ Kapsář za opasek na akuvrtáčku
HU Univerzális tartóerszény akkus csavabehajtóhoz
RO Suport universal pt. bormasina
FR Pochette à perceuse sans-fil
IT Fondina per trapano a batteria
ES Bolsa porta taladradora de acumulador
CN 电钻通用挂袋

HEAVY DUTY
NYLON
WZMOCNIONY
NYLON



YATO

YT-7414

48/96

EN Nail and tool pouch
 PL Kieszka na gwoździe i narzędzia
 DE Gürtelwerkzeugtasche
 RU Карман для гвоздей и инструментов
 CZ Kapsář na nářadí
 HU Szeg és szerszámtartó erszény
 RO Buzunar pt. scule si cule
 FR Pochette à outils et clous
 IT Tasche per chiodi e utensili
 ES Bolsa porta herramientas y accesorios varios
 CN 钉子袋



EN Nail and tool pouch
 PL Kieszka na gwoździe i narzędzia
 DE Gürtelwerkzeugtasche
 RU Карман для гвоздей и инструментов
 CZ Kapsář na nářadí
 HU Szeg és szerszámtartó erszény
 RO Buzunar pt. scule si cule
 FR Pochette à outils et clous
 IT Tasche per chiodi e utensili
 ES Bolsa porta herramientas y accesorios varios
 CN 钉子袋



YATO 
 YT-7416  20/40

YATO 
 YT-7417  39/156

EN Pouch for nails and tools
 PL Sakwa na gwoździe i narzędzia
 DE Werkzeugtasche
 RU Сумка для инструментов
 CZ Univerzální kapsa na nářadí
 HU Impregnált bőr szerszám-szögtáska
 RO Geanta cu buzunare pt. cuie si scule
 IT Multi-poche sac pour outil
 FR Borsa per chiodi e attrezzi
 ES Bolsillo para uñas y herramientas
 CN 工具袋

8 POCKETS
 RIESZENIE
600D POLYESTER



YATO 
 YT-74172  24

EN Nail pocket + hammer loop
 PL Kieszka z uchwytem na młotek
 DE Hammer und Nägel-Gürteltasche
 RU Карман-держатель для молотка
 CZ Kapsář za opasek na kladivo
 HU Szeg tartó erszény kalapástartóval
 RO Suport pt. ciocan
 FR Pochette à outils + porte-marteau
 IT Tasca porta martello
 ES Bolsa con el soporte para martillo
 CN 锤头钉子袋

HEAVY DUTY
 NYLON
 WZMOCNIONY
 NYLON 



YATO 
 YT-7419  40/80

EN Mobile phone pouch
 PL Kieszka na telefon komórkowy
 DE Handy-Gürteltasche
 RU Карман для мобильного телефона
 CZ Pouzdro za opasek na mobilni telefon
 HU Mobil telefon tartó
 RO Suport pt. telefon
 FR Pochette à téléphone portable
 IT Tasca porta cellulare
 ES Bolsa de teléfono móvil
 CN 手机袋

HEAVY DUTY
 NYLON
 WZMOCNIONY
 NYLON 



YATO 
 YT-7420  27/54

EN Tool bag
 PL Torba na narzędzia
 DE Werkzeugtasche
 RU Сумка для инструмента
 CZ Taška montérská
 HU Szerszámos táska
 RO Geanta pt. scule
 FR Sac à outils
 IT Borsa per attrezzi
 ES Bolso de herramientas
 CN 工具包

17 POCKETS
 KESZENIE
600D POLYESTER
 RUBBER
 BOTTOM
 GUMOWE
 DNO 



YATO 
 YT-74360  8

EN Tool bag
 PL Torba na narzędzia
 DE Werkzeugtasche
 RU Сумка для инструмента
 CZ Taška montérská
 HU Szerszámos táska
 RO Geanta pt. scule
 FR Sac à outils
 IT Borsa per attrezzi
 ES Bolso de herramientas
 CN 工具包

15 POCKETS
 KESZENIE
600D POLYESTER
 RUBBER
 BOTTOM
 GUMOWE
 DNO 



YATO 
 YT-74361  6

EN Tool bag
 PL Torba na narzędzia
 DE Werkzeugtasche
 RU Сумка для инструмента
 CZ Taška montérská
 HU Szerszámos táska
 RO Geanta pt. scule
 FR Sac à outils
 IT Borsa per attrezzi
 ES Bolso de herramientas
 CN 工具包

41 POCKETS
 KESZENIE
600D POLYESTER



YATO 
 YT-74351  4

EN Tool bag
PL Torba na narzędzia
DE Werkzeugtasche
RU Сумка для инструмента
CZ Taška montérská
HU Szerszámos táska
RO Geanta pt. scule
FR Sac à outils
IT Borsa per attrezzi
ES Bolso de herramientas
CN 工具包

50
POCKETS
KIESZENIE

HEAVY DUTY
NYLON
WZMOCNIONY
NYLON

STEEL
EDGES
STALOWE
KRAWĘDZIE

EASY OPEN
LATWIE
OTWIERANIE

EASY CLOSE
LATWIE
ZAMYKANIE

EN Tool bag
PL Torba na narzędzia
DE Werkzeugtasche
RU Сумка для инструмента
CZ Taška montérská
HU Szerszámos táska
RO Geanta pt. scule
FR Sac à outils
IT Borsa per attrezzi
ES Bolso de herramientas
CN 工具包

16
POCKETS
KIESZENIE

HEAVY DUTY
NYLON
WZMOCNIONY
NYLON

EN Tool bag
PL Torba na narzędzia
DE Werkzeugtasche
RU Сумка для инструмента
CZ Taška montérská
HU Szerszámos táska
RO Geanta pt. scule
FR Sac à outils
IT Borsa per attrezzi
ES Bolso de herramientas
CN 电工包

31x13
x31
cm

600D
POLYESTER
POLYESTER



YATO
YT-7430

12

YATO
YT-7433

12

YATO
YT-74333

30

EN Open tote tool bag
PL Pojemnik na narzędzia
DE Werkzeugtrage
RU Контейнер для инструментов

CZ Přepravka na nářadí
HU Szerszám tarto csovazas
RO Geanta de otel pt. portbagaj
FR Panier porte-outils

IT Borsa portautentili
ES Maletin de herramientas
CN 工具包

600D
POLYESTER
POLYESTER



16
POCKETS
KIESZENIE

9
POCKETS
KIESZENIE

YATO
YT-74370

6

YATO
YT-74371

6



17
POCKETS
KIESZENIE

11
POCKETS
KIESZENIE

YATO
YT-74372

6

YATO
YT-74373

6

- EN Steel tube tool carrier
- PL Walizka narzędziowa
- DE Werkzeugkoffer
- RU Семодан для инструмента
- CZ Taška na nářadí
- HU Szerszámtartó csővázas
- RO Geanta de oieł pt. portbagaj
- FR Sac à outis
- IT Valigetta per attrezzi
- ES Maletín de herramientas
- CN 钢管柄工具包

31
POCKETS
REZINE

HEAVY DUTY
NYLON
VZMOCNENÝ
NYLON



YATO 
YT-7435

 4

- EN Foldable chair with bag
- PL Torba narzędziowa z krzesłem
- DE Werkzeugtasche mit Klappstuhl
- RU Стул складной с сумкой для инструмента
- CZ Taška na nářadí se stojánkem
- HU Őszecsukható szék tartózsébbel
- RO Scaun rabatabil cu geanta
- FR Sac à outis + tabouret
- IT Sedia pieghevole per borsa attrezzi
- ES Bolsó de herramientas con silla plegable
- CN 带包折叠椅

22
POCKETS
REZINE

max  **90 kg**

HEAVY DUTY
NYLON
VZMOCNENÝ
NYLON



YATO 
YT-7446

 10

- EN Organizer with bins
- PL Organizér z kuwetami
- DE Organizér mit Fächer
- RU Органиайзер с контейнерами
- CZ Organizér na nářadí s přihrádkami
- HU Szerszámszervező kivehető rekeszekkel
- RO Organizator scule cu compartimente
- FR Organisateur avec conteneurs
- IT Organizér con contenitori
- ES Organizador con recipientes
- CN 工具箱

490x420
x115
mm

x12

PP **AI**



YATO 
YT-08960

 4

- EN Toolbox
- PL Skrzynka narzędziowa
- DE Werkzeugkoffer
- RU Ящик для инструментов
- CZ Škříňka na nářadí
- HU Szerszámoszláda
- RO Cutie pt. scule
- FR Boite à outis
- IT Casseta degli attrezzi
- ES Caja de herramientas
- CN 工具箱

560x305
x165
mm

x21

PP **AI**



YATO 
YT-08970

 3

- EN System organizer
- PL Organizér systemowy
- DE System-Sortimentskasten
- RU Системный органиайзер
- CZ Systémový ortganizér
- HU Csavartartó doboz
- RO Modul organizator
- FR Organisateur outis système
- IT Portautensili modulare
- ES Organizador modular
- CN 工具箱

257x180
x66
mm



YATO 
YT-09177

 6

- EN System organizer
- PL Organizér systemowy
- DE System-Sortimentskasten
- RU Системный органиайзер
- HU Rendszer szervező
- RO Modul organizator
- FR Organisateur outis système
- IT Portautensili modulare
- ES Organizador modular
- CN 工具箱

263x363
x77
mm

M



YATO 
YT-09182

 1

EN System organizer
PL Organizer systemowy
DE System-Sortimentskasten
RU Системный органайзер
CZ Systémový organizér
HU Csavartartó doboz

RO Modul organizator
FR Organisateur outils système
IT Portautensili modulari
ES Organizador modular
CN 工具箱

452x296
x79
mm



YATO 

YT-09178



1

EN System organizer
PL Organizer systemowy
DE System-Sortimentskasten
RU Системный органайзер
CZ Systémový organizér
HU Csavartartó doboz

RO Modul organizator
FR Organisateur outils système
IT Portautensili modulari
ES Organizador modular
CN 工具箱

531x379
x77
mm



YATO 

YT-09181



1

EN System tote tool box
PL Pojemnik systemowy
DE System-Werkzeugcontainer
RU Ящик системный для инструментов
CZ Systémový box
HU Szerszámdoboz

RO Modul lada scule
FR Boîte à outils système
IT Contenitore portautensili modulari
ES Caja de herramientas modular
CN 工具箱

576x359
x237
mm



YATO 

YT-09168



1

EN System organizer
PL Organizer systemowy
DE System-Sortimentskasten
RU Системный органайзер
CZ Systémový organizér
HU Csavartartó doboz

RO Modul organizator
FR Organisateur outils système
IT Portautensili modulari
ES Organizador modular
CN 工具箱

452x358
x110
mm



YATO 

YT-09179



1

EN System organizer
PL Organizer systemowy
DE System-Sortimentskasten
RU Системный органайзер
CZ Systémový organizér
HU Csavartartó doboz

RO Modul organizator
FR Organisateur outils système
IT Portautensili modulari
ES Organizador modular
CN 工具箱

585x387
x131
mm



YATO 

YT-09180



1

EN System tote tool box
PL Pojemnik systemowy
DE System-Werkzeugcontainer
RU Ящик системный для инструментов
CZ Systémový box
HU Szerszámdoboz
RO Modul lada scule
FR Boîte à outils système
IT Contenitore portautensili modulari
ES Caja de herramientas modular
CN 工具箱

450x310
x129
mm



YATO 

YT-091681

Series / Seria

S12



1

- EN Power tool box
- PL Skrzynka na elektronarzędzia
- DE Koffer für Elektrowerkzeuge
- RU Ящик для электроинструментов
- CZ Box na elektronářadí
- HU Szerszámosláda elektromos szerszámokhoz
- RO Cutie pt. scule electrice
- FR Boite à outils électriques
- IT Cassetta porta attrezzi elettrici
- ES Caja para herramientas eléctricas
- CN 电动工具箱

450x322
x126
mm



YATO 

YT-09170



1

- EN Toolbox
- PL Skrzynka narzędziowa
- DE Werkzeugkoffer
- RU Ящик для инструментов
- CZ Skříňka na nářadí
- HU Szerszámosláda
- RO Modul cutie scule
- FR Boite à outils
- IT Cassetta degli attrezzi
- ES Caja de herramientas
- CN 工具箱

450x260
x240
mm



YATO 

YT-09183



1

- EN Tool box with drawers
- PL Skrzynka z szufladami
- DE Werkzeugkiste mit Schubladen
- RU Ящик для инструментов с ящиками
- CZ Skříňka na nářadí se zásuvkami
- HU Fiókos szerszámosláda
- RO Cutie scule cu sertare
- FR Boite à outils avec tiroirs
- IT Cassetta porta attrezzi con cassetti
- ES Caja de herramientas con cajones
- CN 带抽屉工具箱

450x313
x245
mm



YATO 

Drawer quantity / Liczba szuflad

Series / Seria



YT-08973

2

S12

1

- EN Tool box with drawers
- PL Skrzynka z szufladami
- DE Werkzeugkiste mit Schubladen
- RU Ящик для инструментов с ящиками
- CZ Skříňka na nářadí se zásuvkami
- HU Fiókos szerszámosláda
- RO Cutie scule cu sertare
- FR Boite à outils avec tiroirs
- IT Cassetta porta attrezzi con cassetti
- ES Caja de herramientas con cajones
- CN 带抽屉工具箱

450x320
x240
mm



YATO 

YT-09184



1

- EN Tool box with drawers
- PL Skrzynka z szufladami
- DE Werkzeugkiste mit Schubladen
- RU Ящик для инструментов с ящиками
- CZ Skříňka na nářadí se zásuvkami
- HU Fiókos szerszámosláda
- RO Cutie scule cu sertare
- FR Boite à outils avec tiroirs
- IT Cassetta porta attrezzi con cassetti
- ES Caja de herramientas con cajones
- CN 带抽屉工具箱



YATO 

Drawer quantity / Liczba szuflad

Series / Seria



YT-08974

3

S12

1

EN System tool box with organizers
PL Skrzynia z organizerami
DE Box mit Organizern
RU Ящик с организерами
CZ Box s organizéry
HU Láda szervezőkkel
RO Cutie scule modulara cu organizator
FR Boite de rangement
IT Cassa portautensili con organizer
ES Caja con organizador
CN 工具箱

241x450
x321
mm



YATO
YT-09163



1

EN System tool box
PL Skrzynia systemowa
DE System-Werkzeugkoffer
RU Системный ящик для инструментов
CZ Systémová skříň
HU Szerszámosláda

RO Modul cutie scule
FR Boite à outils modulaire
IT Cassetta portautensili modulare
ES Caja de herramientas modular
CN 工具箱

585x385
x190
mm



YATO
YT-09169



1

EN System tool box
PL Skrzynia systemowa
DE System-Werkzeugkoffer
RU Системный ящик для инструментов
CZ Systémová skříň
HU Szerszámosláda
RO Modul cutie scule
FR Boite à outils modulaire
IT Cassetta portautensili modulare
ES Caja de herramientas modular
CN 工具箱

584x385
x165
mm



YATO
YT-091692

Series / Seria
S1



1

EN System tool box
PL Skrzynia systemowa
DE System-Werkzeugkoffer
RU Системный ящик для инструментов
CZ Systémová skříň
HU Szerszámosláda

RO Modul cutie scule
FR Boite à outils modulaire
IT Cassetta portautensili modulare
ES Caja de herramientas modular
CN 工具箱

241x450
x321
mm



YATO
YT-09164



1

EN System tool box
PL Skrzynia systemowa
DE System-Werkzeugkoffer
RU Системный ящик для инструментов
CZ Systémová skříň
HU Szerszámosláda
RO Modul cutie scule
FR Boite à outils modulaire
IT Cassetta portautensili modulare
ES Caja de herramientas modular
CN 工具箱

450x332
x170
mm



YATO
YT-091844

Series / Seria
S12



1

EN System tool box
PL Skrzynia systemowa
DE System-Werkzeugkoffer
RU Системный ящик для инструментов
CZ Systémová skříň
HU Szerszámosláda

RO Modul cutie scule
FR Boite à outils modulaire
IT Cassetta portautensili modulare
ES Caja de herramientas modular
CN 工具箱

585x385
x320
mm



YATO
YT-09167



1





EN System tool box
 PL Skrzynia systemowa
 DE System-Werkzeugkoffer
 RU Системный ящик для инструментов
 CZ Systémová skříň
 HU Szerszámosláda
 RO Modul cutie scule
 FR Boîte à outils modulaire
 IT Cassetta portautensili modulare
 ES Caja de herramientas modular
 CN 工具箱

584x385
x295
mm 



YATO  Series / Seria 
 YT-091691 S1 1

EN System tool box on wheels
 PL Skrzynia systemowa na kołach
 DE System-Werkzeugkasten auf Rädern
 RU Системный ящик на колесиках
 CZ Systémová skříň na kolech
 HU Kerekesszerszámosláda
 RO Modul cutie scule cu roti
 FR Boîte à outils modulaire roulante
 IT Cassetta portautensili modulare con ruote
 ES Caja de herramientas modular con ruedas
 CN 工具箱

347x450
x381
mm 
 975
685
mm 
 2x  



YATO  
 YT-09165 1





EN System tool box on wheels
 PL Skrzynia systemowa na kołach
 DE System-Werkzeugkasten auf Rädern
 RU Системный ящик на колесиках
 CZ Systémová skříň na kolech
 HU Kerekesszerszámosláda
 RO Modul cutie scule cu roti
 FR Boîte à outils modulaire roulante
 IT Cassetta portautensili modulare con ruote
 ES Caja de herramientas modular con ruedas
 CN 工具箱

585x425
x410
mm 
 2x  



YATO  
 YT-09166 1

EN System tool box on wheels
 PL Skrzynia systemowa na kołach
 DE System-Werkzeugkasten auf Rädern
 RU Системный ящик на колесиках
 CZ Systémová skříň na kolech
 HU Kerekesszerszámosláda
 RO Modul cutie scule cu roti
 FR Boîte à outils modulaire roulante
 IT Cassetta portautensili modulare con ruote
 ES Caja de herramientas modular con ruedas
 CN 工具箱

660x643
x483
mm 
 1038
660
mm 
 2x  



YATO  Series / Seria 
 YT-09159 S1 1



EN Tool box set
 PL Zestaw skrzyniek
 DE Werkzeugkoffer-Set
 RU Набор ящиков
 CZ Sada skříňek
 HU Ládakészlet
 RO Set cutii scule tip troller
 FR Jeu de caisses à outils
 IT Kit di cassetta porta attrezzi
 ES Juego de cajas de herramientas
 CN 工具箱

2
PCS 
 585x425
x645
mm 
 2x  



YATO  
 YT-09162 1

EN Tool box set
 PL Zestaw skrzyniek
 DE Werkzeugkoffer-Set
 RU Набор ящиков
 CZ Sada skříňek
 HU Ládakészlet
 RO Set cutii scule
 FR Jeu de caisses à outils
 IT Kit di cassetta porta attrezzi
 ES Juego de cajas de herramientas
 CN 工具箱

3
PCS 
 421x450
x323
mm 



YATO  
 YT-09175 20

EN Tool box set
PL Zestaw skrzynek
DE Werkzeugkoffer-Set
RU Набор ящиков
CZ Sada skříněk
HU Ládakészlet
RO Set cutii scule tip troller
FR Jeu de caisses à outils
IT Kit di cassette porta attrezzi
ES Juego de cajas de herramientas
CN 工具箱



3
PCS

585x425
x810
mm

2x



EN Tool box set
PL Zestaw skrzynek
DE Werkzeugkoffer-Set
RU Набор ящиков
CZ Sada skříněk
HU Ládakészlet
RO Set cutii scule tip troller
FR Jeu de caisses à outils
IT Kit di cassette porta attrezzi
ES Juego de cajas de herramientas
CN 工具箱



3
PCS

685x450
x380
mm

975
685
mm

2x



YATO
YT-09161

1

YATO
YT-09173

Series / Seria
S12

1

EN Tool box set
PL Zestaw skrzynek
DE Werkzeugkoffer-Set
RU Набор ящиков
CZ Sada skříněk
HU Ládakészlet
RO Set cutii scule tip troller
FR Jeu de caisses à outils
IT Kit di cassette porta attrezzi
ES Juego de cajas de herramientas
CN 工具箱



4
PCS

722x450
x380
mm



EN System tool box on wheels
PL Skrzynia systemowa na kółkach
DE System-Werkzeugkasten auf Rädern
RU Системный ящик на колесиках
CZ Systémová skříněk na kolečkách
HU Kerekes szerszámosláda
RO Modul cutie scule cu roti
FR Boîte à outils modulaire roulante
IT Casseta portautensili modulare con ruote
ES Caja de herramientas modular con ruedas
CN 工具箱

600x400
x345
mm

990
600
mm

2x



YATO
YT-09174

1

YATO
YT-09158

Series / Seria
S1

1

EN Tool box with wheels
PL Skrzynia na kółkach
DE Kasten auf Rädern
RU Ящик на колесиках
CZ Skříněk na kolečkách
HU Kerekes szerszámosláda
RO Cutie scule cu roti
FR Caisse à outils roulante
IT Cassa portautensili con ruote
ES Caja con ruedas
CN 工具箱



793x385
x322
mm

2x



YATO
YT-09185



1

EN Platform on wheels
 PL Platforma na kołach
 DE Plattform mit Rollen
 RU Платформа на колесах
 CZ Přepravní plošina na kolečkách
 HU Kerekes szállító platform
 RO Platforma cu roti
 FR Plateforme à roulettes
 IT Piattaforma con ruote
 ES Plataforma con ruedas
 CN 平板搬运车

507x326
x143
mm

360°
4x



YATO  Series / Seria 
 YT-09190 S12 1

EN Two-parts tool box with wheels
 PL Skrzynka dwupoziomowa na kółkach
 DE Werkzeugkoffer mit zwei Etagen auf Rädern
 RU Двухуровневый ящик на колесах
 CZ Dvoupatrová skříňka na kolečkách
 HU Kétszintes kerekes láda
 RO Troler cu doua cutii scule
 FR Caisse double à outils roulante
 IT Cassetta portautensili a due livelli con ruote
 ES Caja dos niveles con ruedas
 CN 工具箱

495x350
x710
mm

2x







YATO  Series / Seria 
 YT-09160 1



EN Tool box set with platform
 PL Zestaw skrzynek na platformie
 DE Werkzeugkastensatz auf Plattform
 RU Набор ящиков на платформе
 CZ Sada skříňek na nářadí na plošine
 HU Moduláris mobil ládakészlet
 RO Set cutie de scule cu platformă
 FR Jeu de caisses à outils avec plateforme
 IT Kit di cassetta porta attrezzi con piattaforma
 ES Juego de cajas de herramientas en plataforma
 CN 可搬运工具箱

4
PCS

507x326
x745
mm

360°
4x

YATO  Series / Seria 
 YT-09191 S12 1

EN Lifting and moving straps
PL Pasy do przenoszenia mebli
DE Gürtel zum Bewegen von Heben
RU Ремни для переноски мебели
CZ Pohyblivé pásy pro zvedání nábytku
HU Emelő mozgó pántok
RO Curele pt. mutat obiecte
FR Sangles de levage et de déplacement
IT Cinghie per trasporto di mobili
ES Cinturones para llevar muebles
CN 双人手抬带

2 PCS **8x280** cm **PP** 

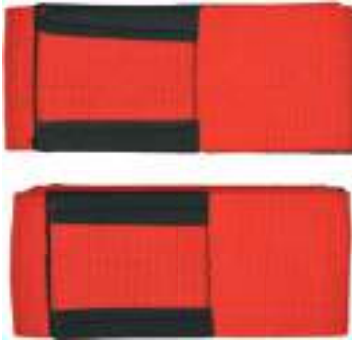

YATO 
YT-74260

18/36

EN Lifting and moving straps
PL Pasy do przenoszenia mebli
DE Gürtel zum Bewegen von Heben
RU Ремни для переноски мебели
CZ Pohyblivé pásy pro zvedání nábytku
HU Emelő mozgó pántok
RO Curele pt. mutat obiecte
FR Sangles de levage et de déplacement
IT Cinghie per trasporto di mobili
ES Cinturones para llevar muebles
CN 双人搬运带

3 PCS **5x370** cm **PP** 



YATO 
YT-74261

10/20

EN Lifting and moving straps
PL Pasy do przenoszenia mebli
DE Gürtel zum Bewegen von Heben
RU Ремни для переноски мебели
CZ Pohyblivé pásy pro zvedání nábytku
HU Emelő mozgó pántok
RO Curele pt. mutat obiecte
FR Sangles de levage et de déplacement
IT Cinghie per trasporto di mobili
ES Cinturones para llevar muebles
CN 双人搬运带

4 PCS **8x280** cm **PP** 

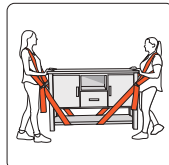

YATO 
YT-74262

8/16

EN Lifting and moving straps
PL Pasy do przenoszenia ładunku
DE Gürtel zum Bewegen von Heben
RU Такелажный ремень для переноски грузов
CZ Pásy pro ruční přenášení nákladu
HU Emelő mozgó pánt
RO Curele pt. mutat obiecte
FR Sangles de levage et de déplacement
IT Cinghia per trasporto di carico
ES Cinta de levantamento e movimiento
CN 环保手提带

8x180 cm **PP** 

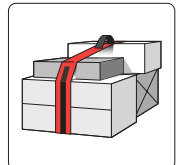

YATO 
YT-74263

25/100

EN Furniture transport roller set
PL Zestaw rolek do transportu mebli
DE Möbel-Transportroller-Set
RU Набор для перемещения мебели
CZ Sada na stěhování nábytku
HU Bútorszállító készlet
RO Set transport si ridicat mobila
FR Paire de roues et de poussoir de transporteur mobile
IT Set di rulli per trasporto di mobili
ES Muebles transporte conjunto
CN 搬运器

5 PCS **max 300kg** 





YATO 
YT-37490

6

EN Lanyard with safety breakaway buckles
PL Linka zabezpieczająca narzędzia
DE Sicherungsleine für Werkzeuge
RU Тросик для предохранения инструментов
CZ Zabezpečovací lanko k nářadí
HU Szerszámrögzítő kötél
RO Cablu siguranta extensibil
FR Cordon de sécurité de l'outil
IT Cavo di ancoraggio per utensile
ES Cable de seguridad para herramientas
CN 弹簧安全绳

52-170 cm 



















YATO 	Ø [mm]	Max. load capacity / Maks. obciążenie [kg]	
YT-74008	1.0	2	24/144
YT-74009	1.5	3	24/144

20

Health & safety articles
Artykuły BHP



Safety glasses Okulary ochronne 574-575		Ear plugs Zatyczki do uszu 583	
Corrective protection glasses Okulary ochronne korekcyjne 575		Hearing protectors Nauszniki przeciwhałasowe 583-585	
Safety goggles Gogle ochronne 575-576		Safety helmets Kaski ochronne 585	
Magnifiers Lupy 576		Working shoes Buty robocze 586-589	
Working gloves Rękawice robocze 576-578		Safety sandals Sandale robocze..... 586	
Working aprons Fartuchy robocze 579		Low-cut safety shoes Półbuty robocze..... 586	
Safety support belts Pasy antyprzeciążeniowe 579		Middle-cut safety shoes Trzewiki robocze..... 588	
Safety harness & accessories Szelki bezpieczeństwa i akcesoria 579-580		Safety boots Buty ochronne wysokie..... 589	
Knee pads Nakolanniki 580		Safety rain boots Kalosze robocze..... 589	
Disposable dust masks Półmaski filtrujące 581-582		Shoes accessories Akcesoria do obuwia..... 589	
		Working socks Skarpety robocze 589	
		Working clothes Odzież robocza 590-598	
		Working jackets Bluzy i kurtki robocze..... 590	
		Working trousers Spodnie robocze..... 593	
		Work bib pants Spodnie robocze ogrodniczki..... 596	
		Rainsuits Komplety przeciwdeszczowe..... 598	

EN Safety glasses
 PL Okulary ochronne
 DE Schutzbrille
 RU Очки защитные открытые
 CZ Ochranné brýle
 HU Védőszemüveg
 RO Ochelari pt. protectie
 FR Lunettes de protection
 IT Occhiali protettivi
 ES Gafas protectoras
 CN 防护眼镜



TYPE 90960 EN 166:2001 F



TYPE 9844 EN 166:2001 F



TYPE 91977 EN 166:2001 F

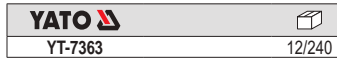

TYPE 91659 EN 166:2001 F



TYPE 91708 EN 166:2001 F



TYPE 91797 EN 166:2001 F



TYPE 91692 EN 166:2001 F



TYPE B524 EN 166:2001 F



TYPE B532 EN 166:2001 F



TYPE 9844 EN 166:2001 F



TYPE 91977 EN 166:2001 F



TYPE 91659 EN 166:2001 F



TYPE 91708 EN 166:2001 F



TYPE 91380 EN 166:2001 F



TYPE B517 EN 166:2001 F



TYPE B532 EN 166:2001 F



EN Safety glasses
 PL Okulary ochronne
 DE Schutzbrille
 RU Очки защитные открытые
 CZ Ochranné brýle
 HU Védőszemüveg
 RO Ochelari pt. protectie
 FR Lunettes de protection
 IT Occhiali protettivi
 ES Gafas protectoras
 CN 防护眼镜



TYPE 92281 EN 166:2001 F

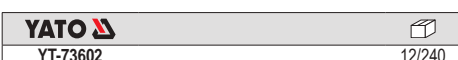

TYPE SG-037 EN 166:2001 F

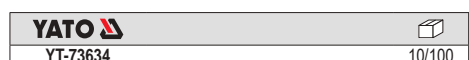
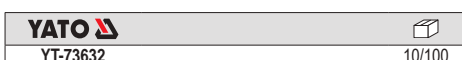

EN Safety glasses
PL Okulary ochronne
DE Schutzbrille
RU Очки защитные
CZ Ochranné brýle
HU Védőszemüveg

RO Ochelari pt. protectie
FR Lunettes de protection
IT Occhiali protettivi
ES Gafas protectoras
CN 劳保眼镜

1
OPTICAL CLASS
KLASA OPTYCZNA

PC

EVA



TYPE 92218SR EN 166:2001 F

YATO
YT-73700 12/240

EN Safety glasses
PL Okulary ochronne
DE Schutzbrille
RU Очки защитные
CZ Ochranné brýle
HU Védőszemüveg

RO Ochelari pt. protectie
FR Lunettes de protection
IT Occhiali protettivi
ES Gafas protectoras
CN 劳保眼镜

1
OPTICAL CLASS
KLASA OPTYCZNA

PC

EVA



TYPE 92281 EN 166:2001 F

YATO
YT-73603 12/240

EN Safety glasses
PL Okulary ochronne
DE Schutzbrille
RU Очки защитные
CZ Ochranné brýle
HU Védőszemüveg

RO Ochelari pt. protectie
FR Lunettes de protection
IT Occhiali protettivi
ES Gafas protectoras
CN 劳保眼镜

1
OPTICAL CLASS
KLASA OPTYCZNA

PC

EVA



TYPE 92218SR EN 166:2001 F

YATO
YT-73701 12/240

EN Safety glasses
PL Okulary ochronne
DE Schutzbrille
RU Очки защитные
HU Védőszemüveg
RO Ochelari pt. protectie
FR Lunettes de protection
IT Occhiali protettivi
ES Gafas protectoras
CN 劳保眼镜

1
OPTICAL CLASS
KLASA OPTYCZNA

PC

TPR

EVA



TYPE 90960FA-RX EN 166:2001 FT

YATO
YT-73621 12/300

EN Safety glasses
PL Okulary ochronne
DE Schutzbrille
RU Очки защитные
HU Védőszemüveg
RO Ochelari pt. protectie
FR Lunettes de protection
IT Occhiali protettivi
ES Gafas protectoras
CN 劳保眼镜

1
OPTICAL CLASS
KLASA OPTYCZNA

PC

TPR

EVA



TYPE 90960FA-RX EN 166:2001 FT

YATO
YT-73702 12/300

EN Safety glasses
PL Okulary ochronne
DE Schutzbrille
RU Очки защитные
HU Védőszemüveg
RO Ochelari pt. protectie
FR Lunettes de protection
IT Occhiali protettivi
ES Gafas protectoras
CN 劳保眼镜

1
OPTICAL CLASS
KLASA OPTYCZNA

PC

TPR

EVA



TYPE 90960FA-RX EN 166:2001 FT

YATO
YT-73703 12/300

EN Corrective protection glasses
PL Okulary ochronne korekcyjne
DE Schutzbrille

RU Очки защитные открытые
CZ Ochranné brýle
HU Védőszemüveg

RO Ochelari pt. protectie
FR Lunettes de sécurité
IT Occhiali da vista di protezione

ES Gafas protectoras
CN 雙光老花眼鏡

1
OPTICAL CLASS
KLASA OPTYCZNA

BIFOCAL
DWU-
OGNISKOWE

PC



TYPE 9844BI 166:2001 F

EN Safety goggles with strap
PL Gogle ochronne z paskiem
DE Schutzbrille
RU Очки защитные
HU Védőszemüveg
RO Ochelari pt. protectie
FR Lunettes de protection
IT Occhiali protettivi con cinghia
ES Gafas protectoras
CN 劳保眼镜

1
OPTICAL CLASS
KLASA OPTYCZNA

PC

EVA



TYPE 92275 EN 166:2001 F

YATO
YT-73765 12/240

EN Safety goggles with strap
PL Gogle ochronne z paskiem
DE Schutzbrille
RU Очки защитные
HU Védőszemüveg
RO Ochelari pt. protectie
FR Lunettes de protection
IT Occhiali protettivi con cinghia
ES Gafas protectoras
CN 劳保眼镜

1
OPTICAL CLASS
KLASA OPTYCZNA

PC

EVA



TYPE 92275 EN 166:2001 F

YATO
YT-73766 12/240

EN Safety goggles
PL Gogle ochronne
DE Schutzbrille
RU Очки защитные
CZ Ochranné brýle
HU Védőszemüveg

1
OPTICAL CLASS
KLASA OPTYCZNA

PC



TYPE 2876 EN 166:2001 F

YATO
YT-7377 12/120

EN Safety goggles
PL Gogle ochronne
DE Schutzbrille
RU Очки защитные
CZ Ochranné brýle
HU Védőszemüveg

RO Ochelari pt. protectie
FR Lunettes de protection
IT Occhiali protettivi
ES Gafas protectoras
CN 防护眼镜

1
OPTICAL CLASS
KLASA OPTYCZNA

PC

SCRATCH PROTECTION
OCZYSZCZENIE PRZED ZARYSOWANIEM



TYPE SG90A EN 166:2001 F

YATO

YT-7380 20/200

EN Safety goggles with indirect ventilation
PL Gogle ochronne z wywietrznikami
DE Schutzbrille mit Lüftung
RU Защищенные очки с вентиляцией
CZ Ochranné brýle s ventilací
HU Védőszemüveg szellőzőnyílásokkal
RO Ochelari protectie cu ventilatie
FR Lunettes de sécurité avec aération
IT Occhiali di protezione con valvole di aerazione
ES Gafas de seguridad con ventilación
CN 防护眼镜

1
OPTICAL CLASS
KLASA OPTYCZNA

PC

PVC



TYPE SG90B-1 EN 166:2001 B

YATO

YT-73810 20/200

EN Safety goggles
PL Gogle ochronne
DE Schutzbrille
RU Очки защитные
CZ Ochranné brýle
HU Védőszemüveg

RO Ochelari pt. protectie
FR Lunettes de protection
IT Occhiali protettivi
ES Gafas protectoras
CN 劳保眼镜

1
OPTICAL CLASS
KLASA OPTYCZNA

PC

SCRATCH PROTECTION
OCZYSZCZENIE PRZED ZARYSOWANIEM

Juv



TYPE SG-60 EN 166:2001 B

YATO

YT-7382 10/100

EN Safety goggles
PL Gogle ochronne
DE Schutzbrille
RU Очки защитные
HU Védőszemüveg
RO Ochelari pt. protectie
FR Lunettes de protection
IT Occhiali protettivi
ES Gafas protectoras
CN 劳保眼镜

1
OPTICAL CLASS
KLASA OPTYCZNA

PC

PVC

Juv

SCRATCH PROTECTION
OCZYSZCZENIE PRZED ZARYSOWANIEM



TYPE B421 EN 166:2001 B

YATO

YT-73830 10/100

EN Safety goggles with indirect ventilation
PL Gogle ochronne z wywietrznikami
DE Schutzbrille mit Lüftung
RU Очки защитные с вентиляцией
CZ Ochranné brýle s ventilací
HU Védőszemüveg szellőzőnyílásokkal
RO Ochelari protectie cu ventilatie
FR Lunettes de sécurité avec aération
IT Occhiali di protezione a mascherina
ES Gafas de seguridad con ventilación
CN 防护眼镜

1
OPTICAL CLASS
KLASA OPTYCZNA

PC

PVC

SCRATCH PROTECTION
OCZYSZCZENIE PRZED ZARYSOWANIEM



TYPE KM2101 EN 166:2001 F

YATO

YT-73831 10/100

EN Safety goggles with indirect ventilation
PL Gogle ochronne z wywietrznikami
DE Schutzbrille mit Lüftung
RU Очки защитные с вентиляцией
CZ Ochranné brýle s ventilací
HU Védőszemüveg szellőzőnyílásokkal
RO Ochelari protectie cu ventilatie
FR Lunettes de sécurité avec aération
IT Occhiali protettivi a mascherina
ES Gafas de seguridad con ventilación
CN 防护眼镜

1
OPTICAL CLASS
KLASA OPTYCZNA

PC

PVC

SCRATCH PROTECTION
OCZYSZCZENIE PRZED ZARYSOWANIEM



TYPE KM2101 EN 166:2001 F

YATO

YT-73832 10/100

EN Magnifier with LED light
PL Lupa z oświetleniem mocowane na głowie
DE Stirnlupe mit Beleuchtung
RU Лупы с подсветкой с креплением на голову
CZ Lupa s osvětlením upevněné na hlavě
HU Fejre rögzíthető nagyító lámpával
RO Ochelari cu lupa si LED
FR Loupes à fixer à la tête avec éclairage
IT Lenti d'ingrandimento da testa con luce
ES Lupa para cabeza con luz
CN 头戴式放大镜

10x **15x** **20x** **25x**

2 LED

ABS

3x
LR1130



Battery not included
Baterii nie dołączono



YATO

YT-73840 60

EN Magnifier with LED light
PL Lupa z oświetleniem mocowane na głowie
DE Stirnlupe mit Beleuchtung
RU Лупы с подсветкой с креплением на голову
CZ Lupa s osvětlením upevněné na hlavě
HU Fejre rögzíthető nagyító lámpával
RO Ochelari cu lupa si LED
FR Loupes à fixer à la tête avec éclairage
IT Lenti d'ingrandimento da testa con luce
ES Lupa para cabeza con luz
CN 头戴式放大镜

1x **1.5x** **2x** **2.5x** **3.5x**

2 LED

ABS

3x
LR1130



Battery not included
Baterii nie dołączono



YATO

YT-73842 40

EN Working gloves
PL Rękawice robocze
DE Arbeitshandschuhe
RU Рабочие перчатки
CZ Pracovní rukavice
HU Munkakesztyű
RO Mănuși de lucru
FR Gants de travail
IT Guanti da lavoro
ES Guantes de trabajo
CN 劳保手套

3121X EN 388

NYLON

NITRILE NITRYL



YATO	Size / Rozmiar	
YT-74754	8	12/144
YT-74755	9	12/144
YT-74756	10	12/144

EN Working gloves
PL Rękawice robocze
DE Arbeitshandschuhe
RU Рабочие перчатки
CZ Pracovní rukavice
HU Munkakesztyű
RO Mănuși de lucru
FR Gants de travail
IT Guanti da lavoro
ES Guantes de trabajo
CN 劳保手套

4131X EN 388

NYLON

SPANDEX

NITRILE NITRYL



YATO	Size / Rozmiar	
YT-74757	8	12/120
YT-74758	9	12/120
YT-74759	10	12/120

EN Working gloves
PL Rękawice robocze
DE Arbeitshandschuhe
RU Рабочие перчатки
CZ Pracovní rukavice
HU Munkakesztyű
RO Mănuși de lucru
FR Gants de travail
IT Guanti da lavoro
ES Guantes de trabajo
CN 劳保手套

3131X EN 388

POLYESTER POLIESTER



PU



YATO	Size / Rozmiar	
YT-74751	8	12/144
YT-74752	9	12/144
YT-74753	10	12/144



EN Working gloves
PL Rękawice robocze
DE Arbeitshandschuhe
RU Рабочие перчатки
CZ Pracovní rukavice
HU Munkakesztyű
RO Mănuși de lucru
FR Gants de travail
IT Guanti da lavoro
ES Guantes de trabajo
CN 劳保手套



YATO 	Size / Rozmiar	
YT-74699	9	50/100
YT-7470	10	50/100



EN Working gloves
PL Rękawice robocze
DE Arbeitshandschuhe
RU Рабочие перчатки
CZ Pracovní rukavice
HU Munkakesztyű
RO Mănuși de lucru
FR Gants de travail
IT Guanti da lavoro
ES Guantes de trabajo
CN 劳保手套



YATO 	Size / Rozmiar	
YT-74719	9	50/100
YT-7472	10	50/100

EN Working gloves
PL Rękawice robocze
DE Arbeitshandschuhe
RU Рабочие перчатки
CZ Pracovní rukavice
HU Munkakesztyű
RO Mănuși de lucru
FR Gants de travail
IT Guanti da lavoro
ES Guantes de trabajo
CN 劳保手套



YATO 	Size / Rozmiar	
YT-74728	8	50/100
YT-74729	9	50/100
YT-7473	10	50/100

EN Working gloves
PL Rękawice robocze
DE Arbeitshandschuhe
RU Рабочие перчатки
CZ Pracovní rukavice
HU Munkakesztyű



RO Mănuși de lucru
FR Gants de travail
IT Guanti da lavoro
ES Guantes de trabajo
CN 劳保手套



NYLON

NITRILE
NITRYL



YATO 	Size / Rozmiar	
YT-74739	9	50/100
YT-7474	10	10/100

EN Working gloves
PL Rękawice robocze
DE Arbeitshandschuhe
RU Рабочие перчатки
CZ Pracovní rukavice
HU Munkakesztyű



RO Mănuși de lucru
FR Gants de travail
IT Guanti da lavoro
ES Guantes de trabajo
CN 劳保手套



PE

NITRILE
NITRYL



YATO 	Size / Rozmiar	
YT-7480	9	12/120
YT-7481	10	12/120

EN Working gloves
PL Rękawice robocze
DE Arbeitshandschuhe
RU Рабочие перчатки
CZ Pracovní rukavice
HU Munkakesztyű



RO Mănuși de lucru
FR Gants de travail
IT Guanti da lavoro
ES Guantes de trabajo
CN 劳保手套



HPPE

PU



YATO 	Size / Rozmiar	
YT-74771	9	12/120
YT-74772	10	12/120



EN Assembly gloves
PL Rękawice ochronne
DE Schutzhandschuhe
RU Защитные перчатки
CZ Ochranné rukavice
HU Védőkesztyű

RO Mănuși protecție
FR Gants de protection
IT Guanti di protezione
ES Guantes de protección
CN 防护手套



COTTON
BAWELNA



YATO 	Size / Rozmiar	
YT-74639	8	10/120
YT-746391	9	10/120
YT-74640	10	10/120



EN Working gloves
PL Rękawice robocze
DE Arbeitshandschuhe
RU Рабочие перчатки
CZ Pracovní rukavice
HU Munkakesztyű

RO Mănuși de lucru
FR Gants de travail
IT Guanti da lavoro
ES Guantes de trabajo
CN 劳保手套



COTTON
BAWELNA



YATO 	Size / Rozmiar	
YT-746418	8	10/120
YT-746419	9	10/120
YT-74642	10	10/120

EN Assembly gloves
PL Rękawice ochronne
DE Schutzhandschuhe
RU Защитные перчатки
CZ Ochranné rukavice
HU Védőkesztyű

RO Mănuși protecție
FR Gants de protection
IT Guanti di protezione
ES Guantes de protección
CN 防护手套

10
SIZE / ROZMIAR



YATO 	Size / Rozmiar	
YT-74645	10	10/120

EN Assembly gloves
PL Rękawice ochronne
DE Schutzhandschuhe
RU Защитные перчатки
CZ Ochranné rukavice
HU Védőkesztyű

RO Mănuși protecție
FR Gants de protection
IT Guanti di protezione
ES Guantes de protección
CN 防护手套

10
SIZE / ROZMIAR



YATO 	Size / Rozmiar	
YT-74647	10	10/120

EN Assembly gloves
PL Rękawice ochronne
DE Schutzhandschuhe
RU Защитные перчатки
CZ Ochranné rukavice
HU Védőkesztyű

RO Mănuși protecție
FR Gants de protection
IT Guanti di protezione
ES Guantes de protección
CN 防护手套

10
SIZE / ROZMIAR



YATO 	Size / Rozmiar	
YT-74650	10	10/120

EN Assembly gloves
PL Rękawice ochronne
DE Schutzhandschuhe
RU Защитные перчатки
CZ Ochranné rukavice
HU Védőkesztyű

RO Mănuși protecție
FR Gants de protection
IT Guanti di protezione
ES Guantes de protección
CN 防护手套

10
SIZE / ROZMIAR



SYNTHETIC
LEATHER
SZTUCZNA
SKÓRA

NYLON



YATO 	Size / Rozmiar	
YT-74670	10	10/120

EN Fingerless assembly gloves
 PL Rękawice ochronne bez palców
 DE Fingerlose Arbeitshandschuhe
 RU Защитные перчатки без пальцев
 CZ Ochranné rukavice bez prstů
 HU Ujjvég nélküli védőkesztyű
 RO Mănuși de lucru
 FR Gants de protection sans doigts
 IT Guanti di protezione senza dita
 ES Guantes de protección sin dedos
 CN 手套

SYNTHETIC LEATHER SZTUCZNA SKÓRA

PU

SPANDEX

EN Fingerless assembly gloves
 PL Rękawice ochronne bez palców
 DE Fingerlose Arbeitshandschuhe
 RU Защитные перчатки без пальцев
 CZ Ochranné rukavice bez prstů
 HU Ujjvég nélküli védőkesztyű
 RO Mănuși de lucru
 FR Gants de protection sans doigts
 IT Guanti di protezione senza dita
 ES Guantes de protección sin dedos
 CN 手套

SYNTHETIC LEATHER SZTUCZNA SKÓRA

PU

SPANDEX

EN Working gloves
 PL Rękawice robocze
 DE Arbeitshandschuhe
 RU Рабочие перчатки
 CZ Pracovní rukavice
 HU Munkakesztyű
 RO Mănuși de lucru
 FR Gants de travail
 IT Guanti da lavoro
 ES Guantes de trabajo
 CN 劳保手套

SYNTHETIC LEATHER SZTUCZNA SKÓRA

COTTON BAWELNA



YATO	Size / Rozmiar	
YT-74658	8	12/72
YT-74659	9	12/72
YT-74660	10	12/72

YATO	Size / Rozmiar	
YT-74661	9	12/72
YT-74662	10	12/72

YATO	Size / Rozmiar	
YT-74651	8	12/120
YT-74652	9	12/120

EN Working gloves
 PL Rękawice robocze
 DE Arbeitshandschuhe
 RU Рабочие перчатки
 CZ Pracovní rukavice
 HU Munkakesztyű
 RO Mănuși de lucru
 FR Gants de travail
 IT Guanti da lavoro
 ES Guantes de trabajo
 CN 劳保手套



SYNTHETIC LEATHER SZTUCZNA SKÓRA

COTTON BAWELNA

EN Working gloves
 PL Rękawice robocze
 DE Arbeitshandschuhe
 RU Рабочие перчатки
 CZ Pracovní rukavice
 HU Munkakesztyű
 RO Mănuși de lucru
 FR Gants de travail
 IT Guanti da lavoro
 ES Guantes de trabajo
 CN 劳保手套



SYNTHETIC LEATHER SZTUCZNA SKÓRA

PU

SPANDEX

YATO	Size / Rozmiar	
YT-74654	8	12/120
YT-74655	9	12/120

YATO	Size / Rozmiar	
YT-746628	8	12/72
YT-74663	9	12/72
YT-74664	10	12/72

EN Working gloves
 PL Rękawice robocze
 DE Arbeitshandschuhe
 RU Рабочие перчатки
 CZ Pracovní rukavice
 HU Munkakesztyű
 RO Mănuși de lucru
 FR Gants de travail
 IT Guanti da lavoro
 ES Guantes de trabajo
 CN 劳保手套



SYNTHETIC LEATHER SZTUCZNA SKÓRA

PU

SPANDEX

EN Working gloves
 PL Rękawice robocze
 DE Arbeitshandschuhe
 RU Рабочие перчатки
 CZ Pracovní rukavice
 HU Munkakesztyű
 RO Mănuși de lucru
 FR Gants de travail
 IT Guanti da lavoro
 ES Guantes de trabajo
 CN 劳保手套



SYNTHETIC LEATHER SZTUCZNA SKÓRA

PU

SPANDEX

YATO	Size / Rozmiar	
YT-746648	8	12/72
YT-74665	9	12/72
YT-74666	10	12/72

YATO	Size / Rozmiar	
YT-74667	9	12/72
YT-74668	10	12/72

EN Welding gloves
 PL Rękawice spawalnicze
 DE Schweißhandschuhe
 RU Сварочные перчатки
 CZ Svářečské rukavice
 HU Hegesztőkesztyű
 RO Manuși pt. sudură
 FR Gants de soudure
 IT Guanti per saldatura
 ES Guantes de soldador
 CN 焊接手套



10 SIZE / ROZMIAR

TIG EN 12477

2122X EN 388

41134X EN 407

2

EN Welding gloves
 PL Rękawice spawalnicze
 DE Schweißhandschuhe
 RU Сварочные перчатки
 CZ Svářečské rukavice
 HU Hegesztőkesztyű
 RO Manuși pt. sudură
 FR Gants de soudure
 IT Guanti per saldatura
 ES Guantes de soldador
 CN 焊接手套



10 SIZE / ROZMIAR

MIG/MAG MMA EN 12477

4243X EN 388

41334X EN 407

2

YATO	Size / Rozmiar	
YT-74820	10	12/120

YATO	Size / Rozmiar	
YT-74824	10	12/72

EN Tool apron
PL Fartuch roboczy
DE Werkzeugschürze
RU Фартук для инструментов
CZ Zástěra na nářadí
HU Kertész kötény
RO Șort pt. scule
FR Outil tablier
IT Grembiule da lavoro
ES Delantal para herramientas
CN 围裙



6
PCS



YATO		
YT-74060		60

EN High visibility elastic adjustable safety support belt
PL Pas antyprzeciążeniowy elastyczny odblaskowy
DE Elastische reflektierende Industriegurt
RU Эластичный поддерживающий пояс с высокой видимостью
CZ Reflexní elastický opasek
HU Hivis rugalmas deréktámasztó öv
RO Cureau de siguranță elastică reglabilă cu vizibilitate ridicată
FR Élastique salut-vis de sécurité retour ceinture de soutien
IT Cintura di sovraccarico ad alta visibilità
ES Cinturón de soporte elástico ajustable de alta visibilidad
CN 护腰带



HOOK FASTENER
RZEP

HIGH VISIBILITY
DOBRA WIDOCZNOŚĆ



YATO	Size / Rozmiar	
YT-74241	XL	50
YT-742411	XXL	50

EN High visibility elastic adjustable safety support belt
PL Pas antyprzeciążeniowy elastyczny odblaskowy
DE Elastische reflektierende Industriegurt
RU Эластичный поддерживающий пояс с высокой видимостью
CZ Reflexní elastický opasek
HU Hivis rugalmas deréktámasztó öv
RO Cureau de siguranță elastică reglabilă cu vizibilitate ridicată
FR Élastique salut-vis de sécurité retour ceinture de soutien
IT Cintura di sovraccarico ad alta visibilità
ES Cinturón de soporte elástico ajustable de alta visibilidad
CN 护腰带

HOOK FASTENER
RZEP

HIGH VISIBILITY
DOBRA WIDOCZNOŚĆ



YATO	Size / Rozmiar	
YT-74242	XL	50
YT-742421	XXL	50

EN Safety harness for working at height
PL Szelki bezpieczeństwa z pasem biodrowym
DE Sicherheitsgurt für Arbeiten in Höhe
RU Страховочная привязь для работы на высоте
CZ Celotělový úvazek
HU Biztonsági heveder
RO Centura de siguranță tip ham
FR Arnés de seguridad
IT Imbracatura di sicurezza con cosciale
ES Harnais de sécurité
CN 高空作业安全带

x4
TOOL LOOP
FELTANRÖZSÖR

max
100 kg

EVA
PADDING
WYCISŁKA

AI



YATO		
YT-74218		5

EN Harness and lanyard set
PL Zestaw szelki i amortyzator
DE Auffanggurt mit Abseilgerät Set
RU Комплект для работ на высоте
CZ Sada šle a tlumič
HU Teljes testheveder és energiaelnyelő kantár szett
RO Set ham și franghie sustinere
FR Kit harnais de protection anti-chutes et amortisseur
IT Set di imbracatura di sicurezza e ammortizzatore
ES Arnés y amortiguador, juego
CN 安全绳

100%
POLYESTER
POLYESTER



YATO		
YT-74235		10

EN Safety harness for working at height
PL Szelki bezpieczeństwa z pasem biodrowym
DE Sicherheitsgurt für Arbeiten in Höhe
RU Страховочная привязь для работы на высоте
CZ Celotělový úvazek
HU Biztonsági heveder
RO Centura de siguranță tip ham
FR Arnés de seguridad
IT Imbracatura di sicurezza con cosciale
ES Harnais de sécurité
CN 高空作业安全带

100%
POLYESTER
POLYESTER



YATO		
YT-74220		10

EN Safety harness for working at height
PL Szelki bezpieczeństwa z pasem biodrowym
DE Sicherheitsgurt für Arbeiten in Höhe
RU Страховочная привязь для работы на высоте
CZ Celotělový úvazek
HU Biztonsági heveder
RO Centura de siguranță tip ham
FR Arnés de seguridad
IT Imbracatura di sicurezza
ES Harnais de sécurité
CN 高空作业安全带

100%
POLYESTER
POLYESTER



YATO		
YT-74221		20

- EN Single shock absorber with rope
- PL Amortyzator z linką
- DE Abseilgerät mit Seil
- RU Амортизатор с тросиком
- CZ Tlumič s lanem
- HU Energiaelnyelő kántár kötéllel
- RO Franghie cu amortizor pt. socuri
- FR Amortisseur avec câble d'attache
- IT Ammortizzatore con cordino
- ES Amortiguador con cable
- CN 安全绳



100%
POLYESTER
POLYESTER

YATO
YT-74236

12

- EN Shock absorber
- PL Amortyzator bezpieczeństwa
- DE Verbindungsmittel mit Bandfalldämpfer
- RU Строн с амортизатором
- CZ Tlumič pádu s karabinou
- HU Energiaelnyelő hevederszalag
- RO Disipator de energie, cu cordon
- FR Cordes de sécurité avec amortisseur de chute
- IT Ammortizzatore di sicurezza
- ES Amortiguador de caída
- CN 安全绳



100%
POLYESTER
POLYESTER

YATO
YT-74227

15

- EN Shock absorber
- PL Amortyzator bezpieczeństwa
- DE Verbindungsmittel mit Bandfalldämpfer
- RU Строн с амортизатором
- CZ Tlumič pádu s karabinou
- HU Energiaelnyelő hevederszalag
- RO Disipator de energie, cu cordon
- FR Cordes de sécurité avec amortisseur de chute
- IT Ammortizzatore di sicurezza
- ES Amortiguador de caída
- CN 高空作业挂绳

1.8 m 45 mm max 100 kg



YATO
YT-74225

10

- EN Stranded hooks
- PL Linka pomocnicza z karabińczykami
- DE Hilfseil mit Karabinerhaken
- RU Вспомогательный тросик с карабинами
- CZ Pomocné lano s karabinami
- HU Segédkötél karabinekkel
- RO Franghie de sustinere
- FR Câble de secours avec mousquetons
- IT Cordino con moschettoni
- ES Cable auxiliar con mosquetones
- CN 安全绳



100%
POLYESTER
POLYESTER

YATO
YT-74231

15

- EN Carabiner hook
- PL Karabińczyk
- DE Karabinerhaken
- RU Карабин
- CZ Karabina
- HU Karabiner
- RO Carabină
- FR Mousqueton
- IT Moschettone
- ES Mosquetón
- CN 弹簧钩



16mm

SELF CLOSING
AUTOMATYCZNE
ZAMYKANIE

MANUAL
LOCKING
RECZNE
BLOKOWANIE

YATO
YT-74229

20

- EN Carabiner hook
- PL Karabińczyk
- DE Karabinerhaken
- RU Карабин
- CZ Karabina
- HU Karabiner
- RO Carabină
- FR Mousqueton
- IT Moschettone
- ES Mosquetón
- CN 大钩



52mm

SELF CLOSING
AUTOMATYCZNE
ZAMYKANIE

YATO
YT-74230

30

- EN Knee pads
- PL Nakolanniki
- DE Knieschützer
- RU Наколенники
- CZ Chráníče kolen
- HU Térdvédő
- RO Genunchiere
- FR Genouillères
- IT Protettore per ginocchio
- ES Rodilleras
- CN 护膝

600D
POLYESTER
POLYESTER

PE

NBR



YATO
YT-74612

20

- EN Gel knee pads
- PL Nakolanniki żelowe
- DE Gel-Knieschoner
- RU Гелевые наколенники
- CZ Nákolenníky gelové
- HU Zselés térdvédő
- RO Genunchiere silicon
- FR Genouillères gel
- IT Ginocchiere in gel
- ES Rodilleras de gel
- CN 护膝

600D
POLYESTER
POLYESTER

EVA

PVC

GEL
SUPPORT
OCHRONA



YATO
YT-7460

12

- EN Gel knee pads
- PL Nakolanniki żelowe
- DE Gel-Knieschoner
- RU Гелевые наколенники
- CZ Nákolenníky gelové
- HU Zselés térdvédő
- RO Genunchiere silicon
- FR Genouillères gel
- IT Ginocchiere in gel
- ES Rodilleras de gel
- CN 护膝

600D
POLYESTER
POLYESTER

EVA

PVC

GEL
SUPPORT
OCHRONA



YATO
YT-7461

12

EN Disposable dust masks
PL Półmaski filtrujące jednorazowe
DE Atemschutzmaske
RU Респиратор противопылевой одноразовый
CZ Protiprašná maska
HU Eldobható porvédőmaszk
RO Masca praf
FR Demi-masques de filtration
IT Maschera filtra polvere
ES Mascarilla desechable para protección contra polvo
CN 折疊口罩



5
PCS
FFP1

EN 149:2001 + A1

YATO 
YT-74970  40/160

EN Disposable dust masks
PL Półmaski filtrujące jednorazowe
DE Atemschutzmaske
RU Респиратор противопылевой одноразовый
CZ Protiprašná maska
HU Eldobható porvédőmaszk
RO Masca praf
FR Demi-masques de filtration
IT Maschera filtra polvere
ES Mascarilla desechable para protección contra polvo
CN 折疊口罩



5
PCS
FFP2

EN 149:2001 + A1

YATO 
YT-74971  40/160

EN Disposable dust masks
PL Półmaski filtrujące jednorazowe
DE Atemschutzmaske
RU Респиратор противопылевой одноразовый
CZ Protiprašná maska
HU Eldobható porvédőmaszk
RO Masca praf
FR Demi-masques de filtration
IT Maschera filtra polvere
ES Mascarilla desechable para protección contra polvo
CN 折疊口罩



5
PCS
FFP3

EN 149:2001 + A1

YATO 
YT-74972  40/160

EN Disposable dust masks with valve
PL Półmaski filtrujące jednorazowe z zaworem
DE Atemschutzmaske mit Ventil
RU Респиратор противопылевой одноразовый с клапаном
CZ Protiprašná maska s ventilem
HU Eldobható porvédőmaszk, szelepes
RO Masca praf cu valva
FR Demi-masques de filtration
IT Maschera respiratoria con valvola di espirazione
ES Mascarilla desechable para protección contra polvo
CN 帶閥防尘面罩



5
PCS
FFP1

EN 149:2001 + A1

YATO 
YT-74980  20/80

EN Disposable dust masks with valve
PL Półmaski filtrujące jednorazowe z zaworem
DE Atemschutzmaske mit Ventil
RU Респиратор противопылевой одноразовый с клапаном
CZ Protiprašná maska s ventilem
HU Eldobható porvédőmaszk, szelepes
RO Masca praf cu valva
FR Demi-masques de filtration
IT Maschera respiratoria con valvola di espirazione
ES Mascarilla desechable para protección contra polvo
CN 帶閥防尘面罩



5
PCS
FFP2

EN 149:2001 + A1

YATO 
YT-74981  20/80

EN Disposable dust masks with valve
PL Półmaski filtrujące jednorazowe z zaworem
DE Atemschutzmaske mit Ventil
RU Респиратор противопылевой одноразовый с клапаном
CZ Protiprašná maska s ventilem
HU Eldobható porvédőmaszk, szelepes
RO Masca praf cu valva
FR Demi-masques de filtration
IT Maschera respiratoria con valvola di espirazione
ES Mascarilla desechable para protección contra polvo
CN 帶閥防尘面罩



5
PCS
FFP3

EN 149:2001 + A1

YATO 
YT-74982  20/80

EN Disposable dust masks
PL Półmaski filtrujące jednorazowe
DE Atemschutzmaske
RU Респиратор противопылевой одноразовый
CZ Protiprašná maska
HU Eldobható porvédőmaszk
RO Masca praf
FR Demi-masques de filtration
IT Maschera filtra polvere
ES Mascarilla desechable para protección contra polvo
CN 折疊口罩



2
PCS
FFP1

EN 149:2001 + A1

YATO 
YT-74852  50

EN Disposable dust masks
PL Półmaski filtrujące jednorazowe
DE Atemschutzmaske
RU Респиратор противопылевой одноразовый
CZ Protiprašná maska
HU Eldobható porvédőmaszk
RO Masca praf
FR Demi-masques de filtration
IT Maschera filtra polvere
ES Mascarilla desechable para protección contra polvo
CN 折疊口罩



3
PCS
FFP1

EN 149:2001 + A1

YATO 
YT-7485  25/50

EN Disposable dust mask with valve
 PL Półmaska filtrująca jednorazowa z zaworem
 DE Atemschutzmaske mit Ventil
 RU Респиратор противопылевой одноразовый с клапаном
 CZ Protiprašná maska s ventilem
 HU Eldobható porvédőmaszk, szelepes
 RO Masca praf cu valva
 FR Demi-masques de filtration
 IT Maschera respiratoria con valvola di espirazione
 ES Mascarilla desechable para protección contra polvo
 CN 带阀防尘面罩



FFP1

EN 149:2001 + A1

YATO 	
YT-74862	50

EN Disposable dust masks with valve
 PL Półmaski filtrujące jednorazowe z zaworem
 DE Atemschutzmaske mit Ventil
 RU Респиратор противопылевой одноразовый с клапаном
 CZ Protiprašná maska s ventilem
 HU Eldobható porvédőmaszk, szelepes
 RO Masca praf cu valva
 FR Demi-masques de filtration
 IT Maschera respiratoria con valvola di espirazione
 ES Mascarilla desechable para protección contra polvo
 CN 带阀防尘面罩



3 PCS
FFP1

EN 149:2001 + A1

YATO 	
YT-7486	25/50

EN Disposable dust masks
 PL Półmaski filtrujące jednorazowe
 DE Atemschutzmaske
 RU Респиратор противопылевой одноразовый
 CZ Protiprašná maska
 HU Eldobható porvédőmaszk
 RO Masca praf
 FR Demi-masques de filtration
 IT Maschera filtra polvere
 ES Mascarilla desechable para protección contra polvo
 CN 折叠口罩



3 PCS
FFP1

EN 149:2001 + A1

YATO 	
YT-74870	50

EN Disposable dust masks with valve
 PL Półmaski filtrujące jednorazowe z zaworem
 DE Atemschutzmaske mit Ventil
 RU Респиратор противопылевой одноразовый с клапаном
 CZ Protiprašná maska s ventilem
 HU Eldobható porvédőmaszk, szelepes
 RO Masca praf cu valva
 FR Demi-masques de filtration
 IT Maschera respiratoria con valvola di espirazione
 ES Mascarilla desechable para protección contra polvo
 CN 带阀防尘面罩



3 PCS
FFP1

EN 149:2001 + A1

YATO 	
YT-7488	50/50

EN Disposable dust masks with valve
 PL Półmaski filtrujące jednorazowe z zaworem
 DE Atemschutzmaske mit Ventil
 RU Респиратор противопылевой одноразовый с клапаном
 CZ Protiprašná maska s ventilem
 HU Eldobható porvédőmaszk, szelepes
 RO Masca praf cu valva
 FR Demi-masques de filtration
 IT Maschera respiratoria con valvola di espirazione
 ES Mascarilla desechable para protección contra polvo
 CN 带阀防尘面罩



3 PCS
FFP2

EN 149:2001 + A1

YATO 	
YT-74917	50

EN Disposable dust masks with valve
 PL Półmaski filtrujące jednorazowe z zaworem
 DE Atemschutzmaske mit Ventil
 RU Респиратор противопылевой одноразовый с клапаном
 CZ Protiprašná maska s ventilem
 HU Eldobható porvédőmaszk, szelepes
 RO Masca praf cu valva
 FR Demi-masques de filtration
 IT Maschera respiratoria con valvola di espirazione
 ES Mascarilla desechable para protección contra polvo
 CN 带阀防尘面罩



3 PCS
FFP2

EN 149:2001 + A1

YATO 	
YT-7492	15/50

EN Disposable dust masks
 PL Półmaski filtrujące jednorazowe
 DE Atemschutzmaske
 RU Респиратор противопылевой одноразовый
 CZ Protiprašná maska
 HU Eldobható porvédőmaszk
 RO Masca praf
 FR Demi-masques de filtration
 IT Maschera filtra polvere
 ES Mascarilla desechable para protección contra polvo
 CN 折叠口罩



2 PCS
FFP2

EN 149:2001 + A1

YATO 	
YT-74919	50

EN Disposable dust mask with valve
 PL Półmaska filtrująca jednorazowa z zaworem
 DE Atemschutzmaske mit Ventil
 RU Респиратор противопылевой одноразовый с клапаном
 CZ Protiprašná maska s ventilem
 HU Eldobható porvédőmaszk, szelepes
 RO Masca praf cu valva
 FR Demi-masques de filtration
 IT Maschera respiratoria con valvola di espirazione
 ES Mascarilla desechable para protección contra polvo
 CN 带阀防尘面罩



FFP2



EN 149:2001 + A1

YATO 	
YT-74949	50

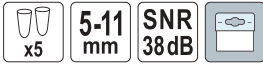
EN Ear plugs
PL Zatyczki do uszu
DE Ohrstöpsel
RU беруши
CZ Zátkové chrániče sluchu
HU Fül dugó
RO Antifoane interne
FR Bouchons anti-bruit
IT Tappi per orecchie
ES Tapones para los oídos
CN 耳塞

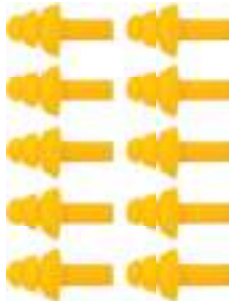
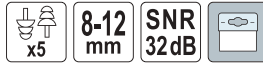

EN Ear plugs
PL Zatyczki do uszu
DE Ohrstöpsel
RU беруши
CZ Zátkové chrániče sluchu
HU Fül dugó
RO Antifoane interne
FR Bouchons anti-bruit
IT Tappi per orecchie
ES Tapones para los oídos
CN 耳塞



EN Ear plugs
PL Zatyczki do uszu
DE Ohrstöpsel
RU беруши
CZ Zátkové chrániče sluchu
HU Fül dugó
RO Antifoane interne
FR Bouchons anti-bruit
IT Tappi per orecchie
ES Tapones para los oídos
CN 耳塞

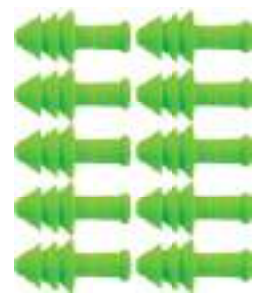

YATO	Ø [mm]	Pairs / Pary	
YT-7451	5-11	5	25/500

YATO	Ø [mm]	Pairs / Pary	
YT-7455	8-12	5	25/500

YATO	Ø [mm]	Pairs / Pary	
YT-74551	7-12	5	40/800

EN Ear plugs
PL Zatyczki do uszu
DE Ohrstöpsel
RU беруши
CZ Zátkové chrániče sluchu
HU Fül dugó
RO Antifoane interne
FR Bouchons anti-bruit
IT Tappi per orecchie
ES Tapones para los oídos
CN 耳塞

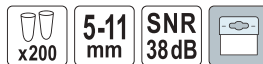

YATO	Ø [mm]	Pairs / Pary	
YT-74510	5-11	200	20

EN Ear plugs
PL Zatyczki do uszu
DE Ohrstöpsel
RU беруши
CZ Zátkové chrániče sluchu
HU Fül dugó
RO Antifoane interne
FR Bouchons anti-bruit
IT Tappi per orecchie
ES Tapones para los oídos
CN 耳塞



YATO	Ø [mm]	Pairs / Pary	
YT-7456	8-12	50	20

EN Ear plugs
PL Zatyczki do uszu na pałąku
DE Ohrstöpsel
RU беруши
CZ Zátkové chrániče sluchu
HU Fül dugó
RO Antifoane interne
FR Bouchons anti-bruit
IT Tappi per orecchie
ES Tapones para los oídos
CN 耳塞



YATO	
YT-7458	25/500

EN Earplug dispenser
PL Dozownik z zatyczkami do uszu
DE Spender mit Ohrstöpseln
RU Дозатор для берушей
CZ Dávkač zátkových chráničů sluchu
HU Fülvédő-adagoló
RO Dozator de dopuri de urechi
FR Distributeur de bouchons d'oreille
IT Distributore di tappi antirumore
ES Dispensador de tapones para los oídos
CN 耳塞分配器



YATO	Ø [mm]	Pairs / Pary	
YT-74520	5-11	250	4

EN Refill bag for earplug dispenser
PL Zatyczki do uszu do dozownika
DE Ohrstöpsel für Spender
RU беруши для дозатора
CZ Zátkové chrániče sluchu pro dávkač
HU Fülvédők adagolóba
RO Pungă de reumplere pt. dozatorul de dopuri de urechi
FR Bouchons d'oreille pour le distributeur
IT Tappi antirumore per il distributore
ES Tapones para los oídos para el dispensador
CN 耳塞



For YT-74520
Dla YT-74520

YATO	Ø [mm]	Pairs / Pary	
YT-74521	5-11	250	20

EN Safety earmuffs
PL Nauszniki przeciwhałasowe
DE Gehörschutz
RU Противошумные наушники
CZ Chrániče sluchu
HU Hallásvédő fültek
RO Căști antifonice
FR Casque anti-bruit
IT Cuffie antirumore
ES Auriculares de protección auditiva
CN 耳罩



YATO	
YT-74624	20

EN Safety earmuffs
PL Nauszniki przeciwhałasowe
DE Gehörschutz
RU Противошумные наушники
CZ Chrániče sluchu
HU Hallásvédő fültek
RO Căști antifonice
FR Casque anti-bruit
IT Cuffie antirumore
ES Auriculares de protección auditiva
CN 耳罩



YATO	
YT-74631	20

EN Safety earmuffs
 PL Nauszniki przeciwhałasowe
 DE Gehörschutz
 RU Противошумные наушники
 CZ Chráníče sluchu
 HU Hallásvédő fültok
 RO Căști antifonice
 FR Casque anti-bruit
 IT Cuffie antirumore
 ES Auriculares de protección auditiva
 CN 耳罩



SNR
26 dB



YATO

YT-7462

40

EN Safety earmuffs
 PL Nauszniki przeciwhałasowe
 DE Gehörschutz
 RU Противошумные наушники
 CZ Chráníče sluchu
 HU Hallásvédő fültok
 RO Căști antifonice
 FR Casque anti-bruit
 IT Cuffie antirumore
 ES Auriculares de protección auditiva
 CN 耳罩



SNR
25 dB



YATO

YT-7463

20

EN Safety earmuffs
 PL Nauszniki przeciwhałasowe
 DE Gehörschutz
 RU Противошумные наушники
 CZ Chráníče sluchu
 HU Hallásvédő fültok
 RO Căști antifonice
 FR Casque anti-bruit
 IT Cuffie antirumore
 ES Auriculares de protección auditiva
 CN 耳罩



SNR
27 dB



YATO

YT-74621

60

EN Safety earmuffs
 PL Nauszniki przeciwhałasowe
 DE Gehörschutz
 RU Противошумные наушники
 CZ Chráníče sluchu
 HU Hallásvédő fültok
 RO Căști antifonice
 FR Casque anti-bruit
 IT Cuffie antirumore
 ES Auriculares de protección auditiva
 CN 耳罩



SNR
26 dB



YATO

YT-74632

40

EN Safety earmuffs
 PL Nauszniki przeciwhałasowe
 DE Gehörschutz
 RU Противошумные наушники
 CZ Chráníče sluchu
 HU Hallásvédő fültok
 RO Căști antifonice
 FR Casque anti-bruit
 IT Cuffie antirumore
 ES Auriculares de protección auditiva
 CN 耳罩



SNR
32 dB



YATO

YT-74633

24

EN Safety earmuffs
 PL Nauszniki przeciwhałasowe
 DE Gehörschutz
 RU Противошумные наушники
 CZ Chráníče sluchu
 HU Hallásvédő fültok
 RO Căști antifonice
 FR Casque anti-bruit
 IT Cuffie antirumore
 ES Auriculares de protección auditiva
 CN 耳罩



SNR
34 dB



YATO

YT-74630

20

EN Combined eye & ear protection muffs
 PL Nauszniki zintegrowane z okularami
 DE Kapselgehörschutz mit Brille integriert
 RU Противошумные наушники с очками
 CZ Chráníče uší integrované s brýlemi
 HU Szemüveggel integrált fülvédő
 RO Set ochelari protectie + antifoane
 FR Protège-oreilles combiné aux lunettes
 IT Cuffie antirumore con occhiali integrati
 ES Orejeras de seguridad con gafas
 CN 二合一护眼耳防护套

SNR
23.9 dB

ABS

PC

1
OPTICAL CLASS
KLASA OPTYCZNA



SCRATCH PROTECTION
OCZRONA PRZED ZARYSOWANIEM



EN Combined eye & ear protection muffs
 PL Nauszniki zintegrowane z okularami
 DE Kapselgehörschutz mit Brille integriert
 RU Противошумные наушники с очками
 CZ Chráníče uší integrované s brýlemi
 HU Szemüveggel integrált fülvédő
 RO Set ochelari protectie + antifoane
 FR Protège-oreilles combiné aux lunettes
 IT Cuffie antirumore con occhiali integrati
 ES Orejeras de seguridad con gafas
 CN 二合一护眼耳防护套

SNR
23.9 dB

ABS

PC

1
OPTICAL CLASS
KLASA OPTYCZNA



SCRATCH PROTECTION
OCZRONA PRZED ZARYSOWANIEM

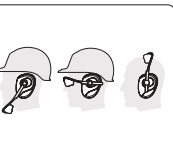
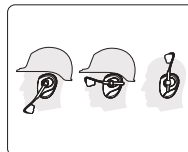

YATO

YT-74635

24

YATO

YT-74636

24

EN Electronic earmuffs
PL Nauszniki przeciwhałasowe elektroniczne
DE Elektronischer Gehörschutz
RU Электронные противошумные наушники
CZ Elektronické protihlukové chrániče sluchu
HU Elektronikus fültök
RO Casti electronice
FR Casque antibruit électronique
IT Cuffie protettive elettroniche
ES Casco antiruido electrónico
CN 电子耳罩

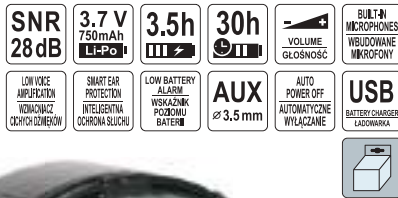

YATO
YT-74625



EN Electronic earmuffs
PL Nauszniki przeciwhałasowe elektroniczne
DE Elektronischer Gehörschutz
RU Электронные противошумные наушники
CZ Elektronické protihlukové chrániče sluchu
HU Elektronikus fültök
RO Casti electronice
FR Casque antibruit électronique
IT Cuffie protettive elettroniche
ES Casco antiruido electrónico
CN 电子耳罩



YATO
YT-74626



EN Replacement grey lens
PL Szkiełka wymienne szare
DE Wechselgläser grau
RU Сменные стекла, серые
CZ Výměnná skla šedá
HU Szürke pótlencse
RO Lentile gri rezervă
FR Verres gris interchangeables
IT Lenti per occhiali grigi
ES Lentes reemplazables, color gris
CN 镜片



For YT-74635, YT-74636
Dla YT-74635, YT-74636

YATO
YT-74637



EN Replacement transparent lens
PL Szkiełka wymienne bezbarwne
DE Wechselgläser klar
RU Сменные стекла, бесцветные
CZ Výměnná skla bezbarvá
HU Színezetlen pótlencse
RO Lentile transparente rezervă
FR Verres transparents interchangeables
IT Lenti per occhiali trasparenti
ES Lentes reemplazables, transparentes
CN 镜片



For YT-74635, YT-74636
Dla YT-74635, YT-74636

YATO
YT-74638



EN Safety helmet
PL Kask ochronny
DE Schutzhelm
RU Каска защитная
CZ Ochranná přilba
HU Védősisak
RO Cască de protecție
FR Casque de sécurité
IT Casco di protezione
ES Casco de protección
CN 安全帽



YATO

Color / Kolor



YT-73970	pomarańczowy	30
YT-73971	żółty	30
YT-73972	biały	30
YT-73973	czerwony	30
YT-73974	niebieski	30
YT-73975	zielony	30

- EN Safety sandals
 PL Sandały robocze
 DE Arbeitshalschuhe
 RU Полуботинки рабочие
 CZ Pracovní polobotky
 HU Munkavédelmi félcipő
- RO Bocanci de lucru
 FR Sandale de sécurité
 IT Sandalo da lavoro
 ES Zapato de trabajo
 CN 劳保鞋



- Composite toe cap
- PU overcup
- Insole & mesh coated EVA
- Shock absorber
- Kompozytowy nosek
- Podeszwa z poliuretanu z noskiem
- Wkładka i wyściółka z materiału EVA
- Amortyzator drgań

SEGURA

YATO	Size / Rozmiar	
YT-80460	36	10
YT-80461	37	10
YT-80462	38	10
YT-80463	39	10
YT-80464	40	10
YT-80465	41	10
YT-80466	42	10
YT-80467	43	10
YT-80468	44	10
YT-80469	45	10
YT-80470	46	10
YT-80471	47	10

- EN Low-cut safety shoes
 PL Półbuty robocze
 DE Arbeitshalschuhe
 RU Полуботинки рабочие
 CZ Pracovní polobotky
 HU Munkavédelmi félcipő
 RO Bocanci de lucru
 FR Chaussure de sécurité
 IT Scarpe da lavoro
 ES Zapato de trabajo
 CN 劳保鞋



- Steel toe cap
- PU sole
- Insole & mesh coated EVA
- Shock absorber
- Stalowy nosek
- Podeszwa z poliuretanu
- Wkładka i wyściółka z materiału EVA
- Amortyzator drgań

PUNO

YATO	Size / Rozmiar	
YT-80521	39	10
YT-80522	40	10
YT-80523	41	10
YT-80524	42	10
YT-80525	43	10
YT-80526	44	10
YT-80527	45	10
YT-80528	46	10
YT-80529	47	10

- EN Low-cut safety shoes
 PL Półbuty robocze
 DE Arbeitshalschuhe
 RU Полуботинки рабочие
 CZ Pracovní polobotky
 HU Munkavédelmi félcipő
 RO Bocanci de lucru
 FR Chaussure de sécurité
 IT Scarpe da lavoro
 ES Zapato de trabajo
 CN 劳保鞋



- Steel toe cap
- PU sole
- Insole & mesh coated EVA
- Shock absorber
- Stalowy nosek
- Podeszwa z poliuretanu
- Wkładka i wyściółka z materiału EVA
- Amortyzator drgań

PIURA

YATO	Size / Rozmiar	
YT-80552	39	10
YT-80553	40	10
YT-80554	41	10
YT-80555	42	10
YT-80556	43	10
YT-80557	44	10
YT-80558	45	10
YT-80559	46	10
YT-80560	47	10

- EN Low-cut safety shoes
 PL Półbuty robocze
 DE Arbeitshalschuhe
 RU Полуботинки рабочие
 CZ Pracovní polobotky
 HU Munkavédelmi félcipő
 RO Bocanci de lucru
 FR Chaussure de sécurité
 IT Scarpe da lavoro
 ES Zapato de trabajo
 CN 劳保鞋



- Steel toe cap
- PU sole
- Insole & mesh coated EVA
- Shock absorber
- Stalowy nosek
- Podeszwa z poliuretanu
- Wkładka i wyściółka z materiału EVA
- Amortyzator drgań

PUEBLE

YATO	Size / Rozmiar	
YT-80583	39	10
YT-80584	40	10
YT-80585	41	10
YT-80586	42	10
YT-80587	43	10
YT-80588	44	10
YT-80589	45	10
YT-80590	46	10
YT-80591	47	10

EN Low-cut safety shoes
PL Półbuty robocze
DE Arbeitshalbschuhe
RU Полуботинки рабочие
CZ Pracovní polobotky
HU Munkavédelmi félcipő
RO Bocanci de lucru
FR Chaussures de sécurité
IT Scarpe da lavoro
ES Zapato de trabajo
CN 劳保鞋



- Steel toe cap
- Puncture-resistant flexible composite midsole
- Breathable and comfortable lining
- Stalowy nosek
- Elastyczna wkładka antyprzebiwoia z tworzywa sztucznego
- Oddychająca i komfortowa wyściółka

PRIME

YATO	Size / Rozmiar	
YT-80530	39	10
YT-80531	40	10
YT-80532	41	10
YT-80533	42	10
YT-80534	43	10

YATO	Size / Rozmiar	
YT-80535	44	10
YT-80536	45	10
YT-80537	46	10
YT-80538	47	10

EN Sport safety shoes
PL Buty ochronne sportowe
DE Sportschutzhühe
RU Спортивная защитная обувь
CZ Sportovní ochranné boty
HU Sport védőcipő
RO Pantof sport de lucru
FR Chaussures de sécurité sport
IT Scarpe antinfortunistiche sportive
ES Calzado de seguridad deportivo
CN 安全鞋



- Steel toe cap
- Puncture-resistant flexible composite midsole
- Comfortable EVA foam insole
- Stalowy nosek
- Elastyczna wkładka antyprzebiwoia z tworzywa sztucznego
- Komfortowa wkładka wewnętrzna z pianki EVA

PAERIS

YATO	Size / Rozmiar	
YT-80641	39	10
YT-80642	40	10
YT-80643	41	10
YT-80644	42	10
YT-80645	43	10

YATO	Size / Rozmiar	
YT-80646	44	10
YT-80647	45	10
YT-80648	46	10
YT-80649	47	10

EN Sport safety shoes
PL Buty ochronne sportowe
DE Sportschutzhühe
RU Спортивная защитная обувь
CZ Sportovní ochranné boty
HU Sport védőcipő
RO Pantof sport de lucru
FR Chaussures de sécurité sport
IT Scarpe antinfortunistiche sportive
ES Calzado de seguridad deportivo
CN 安全鞋



- Steel toe cap
- Puncture-resistant flexible composite midsole
- Comfortable EVA foam insole
- Stalowy nosek
- Elastyczna wkładka antyprzebiwoia z tworzywa sztucznego
- Komfortowa wkładka wewnętrzna z pianki EVA

PACS

YATO	Size / Rozmiar	
YT-80629	36	10
YT-80630	37	10
YT-80631	38	10
YT-80632	39	10
YT-80633	40	10
YT-80634	41	10

YATO	Size / Rozmiar	
YT-80635	42	10
YT-80636	43	10
YT-80637	44	10
YT-80638	45	10
YT-80639	46	10
YT-80640	47	10

EN Low-cut safety shoes
PL Półbuty robocze
DE Arbeitshalbschuhe
RU Полуботинки рабочие
CZ Pracovní polobotky
HU Munkavédelmi félcipő
RO Bocanci de lucru
FR Chaussures de sécurité
IT Scarpe da lavoro
ES Zapato de trabajo
CN 劳保鞋



- Composite toe cap
- Puncture-resistant flexible composite midsole
- Kompozytowy nosek
- Elastyczna wkładka antyprzebiwoia z tworzywa sztucznego

PERA

YATO	Size / Rozmiar	
YT-80488	39	10
YT-80489	40	10
YT-80490	41	10
YT-80491	42	10
YT-80492	43	10

YATO	Size / Rozmiar	
YT-80493	44	10
YT-80494	45	10
YT-80495	46	10
YT-80496	47	10

EN Sport safety shoes
PL Buty ochronne sportowe
DE Sportschutzhühe
RU Спортивная защитная обувь
CZ Sportovní ochranné boty
HU Sport védőcipő
RO Pantof sport de lucru
FR Chaussures de sécurité sport
IT Scarpe antinfortunistiche sportive
ES Calzado de seguridad deportivo
CN 安全鞋



- Steel toe cap
- Puncture-resistant flexible composite midsole
- Comfortable EVA foam insole
- Stalowy nosek
- Elastyczna wkładka antyprzebiwoia z tworzywa sztucznego
- Komfortowa wkładka wewnętrzna z pianki EVA

PUBS

YATO	Size / Rozmiar	
YT-80620	39	10
YT-80621	40	10
YT-80622	41	10
YT-80623	42	10
YT-80624	43	10

YATO	Size / Rozmiar	
YT-80625	44	10
YT-80626	45	10
YT-80627	46	10
YT-80628	47	10

EN Sport safety shoes
PL Buty ochronne sportowe
DE Sportschutzhühe
RU Спортивная защитная обувь
CZ Sportovní ochranné boty
HU Sport védőcipő
RO Pantof sport de lucru
FR Chaussures de sécurité sport
IT Scarpe antinfortunistiche sportive
ES Calzado de seguridad deportivo
CN 防护运动鞋



- Composite toe cap
- Puncture-resistant flexible composite midsole
- Kompozytowy nosek
- Elastyczna wkładka antyprzebiwoia z tworzywa sztucznego

PARAD

YATO	Size / Rozmiar	
YT-80497	39	10
YT-80498	40	10
YT-80499	41	10
YT-80500	42	10
YT-80501	43	10

YATO	Size / Rozmiar	
YT-80502	44	10
YT-80503	45	10
YT-80504	46	10
YT-80505	47	10

EN Sport safety shoes
 PL Buty ochronne sportowe
 DE Sportschutzhuhe
 RU Спортивная защитная обувь
 CZ Sportovní ochranné boty
 HU Sport védőcipő
 RO Pantof sport de lucru
 FR Chaussures de sécurité sport
 IT Scarpe antinfortunistiche sportive
 ES Calzado de seguridad deportivo
 CN 防护运动鞋



- Composite toe cap
- Puncture-resistant flexible composite midsole
- Kompozytowy nosek
- Elastyczna wkładka antyprzebiocowa z tworzywa sztucznego

POMPA

YATO	Size / Rozmiar	
YT-80506	36	10
YT-80507	37	10
YT-80508	38	10
YT-80509	39	10
YT-80510	40	10
YT-80511	41	10

YATO	Size / Rozmiar	
YT-80512	42	10
YT-80513	43	10
YT-80514	44	10
YT-80515	45	10
YT-80516	46	10
YT-80517	47	10

EN Low-cut safety shoes
 PL Półbuty robocze
 DE Arbeitshalbschuhe
 RU Полуботинки рабочие
 CZ Pracovní polobotky
 HU Munkavédelmi félcipő
 RO Bocanci de lucru
 FR Chaussure de sécurité IT Scarpe da lavoro
 ES Zapato de trabajo
 CN 劳保鞋



- Composite toe cap
- Puncture-resistant flexible composite midsole
- Kompozytowy nosek
- Elastyczna wkładka antyprzebiocowa z tworzywa sztucznego

PARAN

YATO	Size / Rozmiar	
YT-80650	39	10
YT-80651	40	10
YT-80652	41	10
YT-80653	42	10
YT-80654	43	10

YATO	Size / Rozmiar	
YT-80655	44	10
YT-80656	45	10
YT-80657	46	10
YT-80658	47	10

EN Middle-cut safety shoes
 PL Trzewiki robocze
 DE Arbeitsschnürschuhe
 RU Ботинки рабочие
 CZ Pracovní boty šněrovací
 HU Munkavédelmi bakancs
 RO Pantof de lucru
 FR Chaussure de sécurité
 IT Scarpe da lavoro
 ES Calzado de trabajo
 CN 劳保鞋



- Composite toe cap
- Puncture-resistant flexible composite midsole
- Kompozytowy nosek
- Elastyczna wkładka antyprzebiocowa z tworzywa sztucznego

TARAN

YATO	Size / Rozmiar	
YT-80750	39	10
YT-80751	40	10
YT-80752	41	10
YT-80753	42	10
YT-80754	43	10

YATO	Size / Rozmiar	
YT-80755	44	10
YT-80756	45	10
YT-80757	46	10
YT-80758	47	10

EN Middle-cut safety shoes
 PL Trzewiki robocze
 DE Arbeitsschnürschuhe
 RU Ботинки рабочие
 CZ Pracovní boty šněrovací
 HU Munkavédelmi bakancs
 RO Pantof de lucru
 FR Chaussure de sécurité
 IT Scarpe da lavoro
 ES Calzado de trabajo
 CN 劳保鞋



- Steel toe cap
- PU sole
- Insole & mesh coated EVA
- Shock absorber
- Stalowy nosek
- Podeszwa z poliuretanu
- Wkładka i wyściółka z materiału EVA
- Amortyzator drgań

TRAT

YATO	Size / Rozmiar	
YT-80733	39	10
YT-80734	40	10
YT-80735	41	10
YT-80736	42	10
YT-80737	43	10

YATO	Size / Rozmiar	
YT-80738	44	10
YT-80739	45	10
YT-80740	46	10
YT-80741	47	10

EN Middle-cut safety shoes
 PL Trzewiki robocze
 DE Arbeitsschnürschuhe
 RU Ботинки рабочие
 CZ Pracovní boty šněrovací
 HU Munkavédelmi bakancs
 RO Pantof de lucru
 FR Chaussure de sécurité
 IT Scarpe da lavoro
 ES Calzado de trabajo
 CN 劳保鞋



- Steel toe cap
- PU sole
- Insole & mesh coated EVA
- Shock absorber
- Stalowy nosek
- Podeszwa z poliuretanu
- Wkładka i wyściółka z materiału EVA
- Amortyzator drgań

TEZU

YATO	Size / Rozmiar	
YT-80841	39	10
YT-80842	40	10
YT-80843	41	10
YT-80844	42	10
YT-80845	43	10

YATO	Size / Rozmiar	
YT-80846	44	10
YT-80847	45	10
YT-80848	46	10
YT-80849	47	10

EN Middle-cut safety shoes
 PL Trzewiki robocze
 DE Arbeitsschnürschuhe
 RU Ботинки рабочие
 CZ Pracovní boty šněrovací
 HU Munkavédelmi bakancs
 RO Pantof de lucru
 FR Chaussure de sécurité
 IT Scarpe da lavoro
 ES Calzado de trabajo
 CN 劳保鞋



- Steel toe cap
- PU sole
- Insole & mesh coated EVA
- Shock absorber
- Stalowy nosek
- Podeszwa z poliuretanu
- Wkładka i wyściółka z materiału EVA
- Amortyzator drgań

TOLU

YATO	Size / Rozmiar	
YT-80794	39	10
YT-80795	40	10
YT-80796	41	10
YT-80797	42	10
YT-80798	43	10

YATO	Size / Rozmiar	
YT-80799	44	10
YT-80800	45	10
YT-80801	46	10
YT-80802	47	10

EN Middle-cut safety shoes
PL Trzewiki robocze
DE Arbeitsschnürschuhe
RU Ботинки рабочие
CZ Pracovní boty středovaci
HU Munkavédelmi bakancs
RO Pantof de lucru
FR Chaussure de sécurité
IT Scarpe da lavoro
ES Calzado de trabajo
CN 劳保鞋

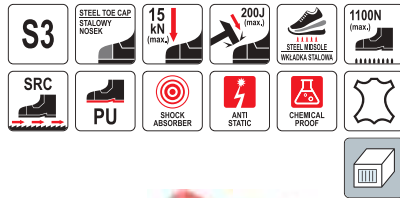

- Steel toe cap
- PU sole
- Insole & mesh coated EVA
- Shock absorber
- Stalowy nosek
- Podeszwa z poliuretanu
- Wkładka i wyściółka z materiału EVA
- Amortyzator drgań

TWER

YATO	Size / Rozmiar	
YT-80783	39	10
YT-80784	40	10
YT-80785	41	10
YT-80786	42	10
YT-80787	43	10

YATO	Size / Rozmiar	
YT-80788	44	10
YT-80789	45	10
YT-80790	46	10
YT-80791	47	10

EN Safety boots
PL Buty ochronne wysokie
DE Schutzstiefel
RU Защитные ботинки выше щиколотки
CZ Vysoké ochranné boty
HU Magas védőcipő
RO Bocanci de lucru inalti
FR Chaussures de sécurité hautes
IT Scarpe antinfortunistiche alte
ES Botas de seguridad
CN 高防护靴



- Steel toe cap
- Puncture-resistant steel midsole
- Stalowy nosek
- Stalowa wkładka antyprzebićowa

GORA

YATO	Size / Rozmiar	
YT-80701	39	5
YT-80702	40	5
YT-80703	41	5
YT-80704	42	5
YT-80705	43	5

YATO	Size / Rozmiar	
YT-80706	44	5
YT-80707	45	5
YT-80708	46	5
YT-80709	47	5

EN Safety rain boots
PL Kalosze z metalowym podnoskiem
DE Gummistiefel mit Metall-Zehenschutzkappe
RU Резиновые сапоги с металлическим подноском
CZ Holinky s kovovou špičkou
HU Fém ormerevítős gumicsizma
RO Cizme de protecție din cauciuc pt. ploaie
FR Bottes en caoutchouc de sécurité
IT Stivali di gomma con puntale in metallo
ES Botas de goma con punta metálica
CN 安全雨鞋



- Steel toe cap
- Knee high PVC boots
- Cleated PVC outsole
- Shock absorber
- Stalowy nosek
- Cholewka z PVC do kolana
- Wyrzeźbiona podeszwa z PVC
- Amortyzator drgań

PORTLAND

YATO	Size / Rozmiar	
YT-80881	39	8
YT-80882	40	8
YT-80883	41	8
YT-80884	42	8

YATO	Size / Rozmiar	
YT-80885	43	8
YT-80886	44	8
YT-80887	45	8
YT-80888	46	8

EN Premium shoe insoles
PL Wkładki do butów premium
DE Premium-Schuheinlagen
RU Стельки для обуви
CZ Vložky do bot premium
HU Prémium talbatétek
RO Branturi premium pt. pantofi
FR Semelles de chaussures premium
IT Solette premium per scarpe
ES Plantillas premium para botas
CN 鞋垫



YATO	Size / Rozmiar	L [cm]	
YT-808701	39	26.0	7/70
YT-808702	40	27.0	7/70
YT-808703	41	27.5	7/70
YT-808704	42	28.0	7/70
YT-808705	43	28.5	7/70

YATO	Size / Rozmiar	L [cm]	
YT-808706	44	29.0	7/70
YT-808707	45	30.0	7/70
YT-808708	46	30.5	7/70
YT-808709	47	31.0	7/70

EN Work socks
PL Skarpety robocze
DE Arbeitsocken
RU Рабочие носки
CZ Ponožky pracovní
HU Munkazokni
RO Șosete de lucru
FR Chaussettes de travail
IT Calzini da lavoro
ES Calcetines de trabajo
CN 长工作袜



75% cotton, 22% polyester, 3% spandex
75% bawełna, 22% poliester, 3% spandex

YATO	Size / Rozmiar	
YT-78340	39-42	4/40
YT-78341	43-46	4/40

EN Work socks
PL Skarpety robocze
DE Arbeitsocken
RU Рабочие носки
CZ Ponožky pracovní
HU Munkazokni
RO Șosete de lucru
FR Chaussettes de travail
IT Calzini da lavoro
ES Calcetines de trabajo
CN 短工作袜



75% cotton, 22% polyester, 3% spandex
75% bawełna, 22% poliester, 3% spandex

YATO	Size / Rozmiar	
YT-78342	39-42	4/40
YT-78343	43-46	4/40



EN Softshell jacket
 PL Kurtka softshell
 DE Softshelljacke
 RU Softshell kыpтka
 CZ Softshellová bunda
 HU Softshell dzseki
 RO Jacheta softshell
 FR Veste softshell
 IT Giacca softshell
 ES Chaqueta softshell
 CN 冲锋衣



96% polyester, 4% spandex
 96% poliester, 4% spandex





 **320 g/m²** SOFTSHELL

 **8000 mm**  **3000 g/m²**

3 POCKETS / KIESZENE 

OBSIDIAN

YATO 	Size / Rozmiar	
YT-79550	S (EU) / 34 (US)	10
YT-79551	M (EU) / 36 (US)	10
YT-79552	L (EU) / 38 (US)	10
YT-79553	XL (EU) / 40 (US)	10
YT-79554	XXL (EU) / 42 (US)	10
YT-79555	XXXL (EU) / 44 (US)	10



EN Softshell jacket
 PL Kurtka softshell
 DE Softshelljacke
 RU Softshell kыpтka
 CZ Softshellová bunda
 HU Softshell dzseki
 RO Jacheta softshell
 FR Veste softshell
 IT Giacca softshell
 ES Chaqueta softshell
 CN 冲锋衣



96% polyester, 4% spandex
 96% poliester, 4% spandex





 **320 g/m²** SOFTSHELL

 **8000 mm**  **3000 g/m²**

3 POCKETS / KIESZENE 

STRATUS

YATO 	Size / Rozmiar	
YT-79560	S (EU) / 34 (US)	10
YT-79561	M (EU) / 36 (US)	10
YT-79562	L (EU) / 38 (US)	10
YT-79563	XL (EU) / 40 (US)	10
YT-79564	XXL (EU) / 42 (US)	10
YT-79565	XXXL (EU) / 44 (US)	10



EN Softshell jacket
 PL Kurtka softshell
 DE Softshelljacke
 RU Softshell kыpтka
 CZ Softshellová bunda
 HU Softshell dzseki
 RO Jacheta softshell
 FR Veste softshell
 IT Giacca softshell
 ES Chaqueta softshell
 CN 冲锋衣



96% polyester, 4% spandex
 96% poliester, 4% spandex





 **320 g/m²** SOFTSHELL

 **8000 mm**  **3000 g/m²**

3 POCKETS / KIESZENE 

CUMULUS

YATO 	Size / Rozmiar	
YT-79530	S (EU) / 34 (US)	10
YT-79531	M (EU) / 36 (US)	10
YT-79532	L (EU) / 38 (US)	10
YT-79533	XL (EU) / 40 (US)	10
YT-79534	XXL (EU) / 42 (US)	10
YT-79535	XXXL (EU) / 44 (US)	10



EN Softshell jacket
 PL Kurtka softshell
 DE Softshelljacke
 RU Softshell kыpтka
 CZ Softshellová bunda
 HU Softshell dzseki
 RO Jacheta softshell
 FR Veste softshell
 IT Giacca softshell
 ES Chaqueta softshell
 CN 冲锋衣



96% polyester, 4% spandex
 96% poliester, 4% spandex





 **320 g/m²** SOFTSHELL

 **8000 mm**  **3000 g/m²**

3 POCKETS / KIESZENE 

NIMBOSTRATUS

YATO 	Size / Rozmiar	
YT-79540	S (EU) / 34 (US)	10
YT-79541	M (EU) / 36 (US)	10
YT-79542	L (EU) / 38 (US)	10
YT-79543	XL (EU) / 40 (US)	10
YT-79544	XXL (EU) / 42 (US)	10
YT-79545	XXXL (EU) / 44 (US)	10

EN Hoodie
 PL Bluza z kapturem
 DE Kapuzenpullover
 RU Толстовка с капюшоном
 CZ Mikina s kapucí
 HU Kapucnis melegítő felső
 RO Hanorac cu gluga
 FR Blouson à capuche
 IT Felpa con cappuccio
 ES Sudadera con capucha
 CN 连帽卫衣





80% cotton, 20% polyester
 80% bawełna, 20% poliester



 **300 g/m²**

3 POCKETS / KIESZENE 

LABRADOR

YATO 	Size / Rozmiar	
YT-79210	S (EU) / 34 (US)	20
YT-79211	M (EU) / 36 (US)	20
YT-79212	L (EU) / 38 (US)	20
YT-79213	XL (EU) / 40 (US)	20
YT-79214	XXL (EU) / 42 (US)	20

EN Hoodie
 PL Bluza z kapturem
 DE Kapuzenpullover
 RU Толстовка с капюшоном
 CZ Mikina s kapucí
 HU Kapucnis melegítő felső
 RO Hanorac cu gluga
 FR Blouson à capuche
 IT Felpa con cappuccio
 ES Sudadera con capucha
 CN 连帽卫衣





80% cotton, 20% polyester
 80% bawełna, 20% poliester



 **300 g/m²**

2 POCKETS / KIESZENE 

ROTTWEILER

YATO 	Size / Rozmiar	
YT-79215	S (EU) / 34 (US)	20
YT-79216	M (EU) / 36 (US)	20
YT-79217	L (EU) / 38 (US)	20
YT-79218	XL (EU) / 40 (US)	20
YT-79219	XXL (EU) / 42 (US)	20

EN Hoodie
PL Bluza z kapturem
DE Kapuzenpullover
RU Толстовка с капюшоном
CZ Mikina s kapucí
HU Kapucnis melegítő felső
RO Hanorac cu gluga
FR Blouson à capuche
IT Felpa con cappuccio
ES Sudadera con capucha
CN 连帽卫衣



80% cotton, 20% polyester
80% bawełna, 20% poliester

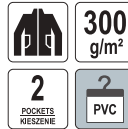

MORO



300
g/m²

YATO 	Size / Rozmiar	
YT-79220	S (EU) / 34 (US)	20
YT-79221	M (EU) / 36 (US)	20
YT-79222	L (EU) / 38 (US)	20
YT-79223	XL (EU) / 40 (US)	20
YT-79224	XXL (EU) / 42 (US)	20

EN Fleece jacket
PL Bluza polarowa
DE Fleecejacke
RU Флисовая кофта
CZ Fleeceová mikina
HU Fleece dzseki
RO Bluza polar
FR Veste polaire
IT Felpa in pile
ES Chaqueta polar
CN 摇粒绒夹克



100% polyester
100% poliester

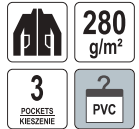

SOFT ROSE



280
g/m²

YATO 	Size / Rozmiar	
YT-79200	S (EU) / 34 (US)	10
YT-79201	M (EU) / 36 (US)	10
YT-79202	L (EU) / 38 (US)	10
YT-79203	XL (EU) / 40 (US)	10
YT-79204	XXL (EU) / 42 (US)	10
YT-79205	XXXL (EU) / 44 (US)	10

EN Fleece jacket
PL Bluza polarowa
DE Fleecejacke
RU Флисовая кофта
CZ Fleeceová mikina
HU Fleece dzseki
RO Bluza polar
FR Veste polaire
IT Felpa in pile
ES Chaqueta polar
CN 摇粒绒夹克



100% polyester
100% poliester



MAX HEAVY



420
g/m²

YATO 	Size / Rozmiar	
YT-79520	S (EU) / 34 (US)	10
YT-79521	M (EU) / 36 (US)	10
YT-79522	L (EU) / 38 (US)	10
YT-79523	XL (EU) / 40 (US)	10
YT-79524	XXL (EU) / 42 (US)	10
YT-79525	XXXL (EU) / 44 (US)	10

EN Working jacket
PL Bluza robocza
DE Arbeitsjacke
RU Рабочая рубашка
CZ Pracovní blůza
HU Munkaruha felső
RO Bluză de lucru
FR Blouson de travail
IT Felpa da lavoro
ES Blusa de trabajo
CN 工作服



65% polyester, 35% cotton
65% poliester, 35% bawełna

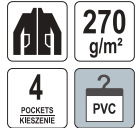

DAN



270
g/m²

YATO 	Size / Rozmiar	
YT-80280	S (EU) / 34 (US)	10
YT-80281	M (EU) / 36 (US)	10
YT-80282	L (EU) / 38 (US)	10
YT-80283	XL (EU) / 40 (US)	10
YT-80284	XXL (EU) / 42 (US)	10

EN Working jacket
PL Bluza robocza
DE Arbeitsjacke
RU Рабочая рубашка
CZ Pracovní blůza
HU Munkaruha felső
RO Bluză de lucru
FR Blouson de travail
IT Felpa da lavoro
ES Blusa de trabajo
CN 工作服



65% polyester, 35% cotton
65% poliester, 35% bawełna

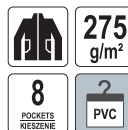

DUERO



275
g/m²

YATO 	Size / Rozmiar	
YT-8020	S (EU) / 34 (US)	20
YT-8021	M (EU) / 36 (US)	10
YT-8022	L (EU) / 38 (US)	10
YT-8023	XL (EU) / 40 (US)	20
YT-8024	XXL (EU) / 42 (US)	10

EN Working jacket
PL Bluza robocza
DE Arbeitsjacke
RU Рабочая рубашка
CZ Pracovní blůza
HU Munkaruha felső
RO Bluză de lucru
FR Blouson de travail
IT Felpa da lavoro
ES Blusa de trabajo
CN 劳保夹克



65% polyester, 35% cotton
65% poliester, 35% bawełna

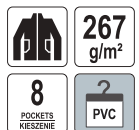

BASALT





267
g/m²

YATO 	Size / Rozmiar	
YT-80140	S	10
YT-80141	M	10
YT-80142	L	10
YT-80143	L/XL	10
YT-80144	XL	10
YT-80145	XXL	10

EN Work jacket
 PL Bluza robocza
 DE Arbeitsjacke
 RU Рабочая рубашка
 CZ Pracovní blůza
 HU Munkaruha felső
 RO Bluză de lucru
 FR Blouson de travail
 IT Felpa da lavoro
 ES Blusa de trabajo
 CN 劳保夹克



 **300**
g/m²



 **7**
POCKETS
KIESZENÉ

 **2**
PVC

100% brushed cotton
 100% szczotkowana bawełna





COMFY

YATO 	Size / Rozmiar	
YT-79230	S	10
YT-79231	M	10
YT-79232	L	10
YT-79233	L/XL	10
YT-79234	XL	10
YT-79235	XXL	10

EN Working jacket
 PL Bluza robocza
 DE Arbeitsjacke
 RU Рабочая рубашка
 CZ Pracovní blůza
 HU Munkaruha felső
 RO Bluză de lucru
 FR Blouson de travail
 IT Felpa da lavoro
 ES Blusa de trabajo
 CN 劳保夹克



 **267**
g/m²



 **8**
POCKETS
KIESZENÉ

 **2**
PVC

65% polyester, 35% cotton
 65% poliester, 35% bawełna





PEGMA

YATO 	Size / Rozmiar	
YT-80176	S	10
YT-80177	M	10
YT-80178	L	10
YT-80179	L/XL	10
YT-80180	XL	10
YT-80181	XXL	10

EN Working jacket
 PL Bluza robocza
 DE Arbeitsjacke
 RU Рабочая рубашка
 CZ Pracovní blůza
 HU Munkaruha felső
 RO Bluză de lucru
 FR Blouson de travail
 IT Felpa da lavoro
 ES Blusa de trabajo
 CN 劳保夹克



 **190**
g/m²



 **8**
POCKETS
KIESZENÉ

 **2**
PVC

65% polyester, 35% cotton
 65% poliester, 35% bawełna



ANDESITE

YATO 	Size / Rozmiar	
YT-80900	S	10
YT-80901	M	10
YT-80902	L	10
YT-80903	L/XL	10
YT-80904	XL	10
YT-80905	XXL	10

EN Working shorts
PL Spodnie robocze krótkie
DE Kurze Arbeitshose
RU Рабочие шорты
CZ Pracovní šortky
HU Munkaruha rövid nadrág
RO Pantaloni scurți de lucru
FR Pantalon de travail court
IT Pantaloni da lavoro corti
ES Pantalónes cortos de trabajo
CN 工装短裤



65% polyester, 35% cotton
65% poliester, 35% bawełna



245
g/m²



DORIA

YATO 	Size / Rozmiar	
YT-80924	S	10
YT-80925	M	10
YT-80926	L	10
YT-80927	L/XL	10
YT-80928	XL	10
YT-80929	XXL	10

EN Working shorts
PL Spodnie robocze krótkie
DE Kurze Arbeitshose
RU Рабочие шорты
CZ Pracovní šortky
HU Munkaruha rövid nadrág
RO Pantaloni scurți de lucru
FR Pantalon de travail court
IT Pantaloni da lavoro corti
ES Pantalónes cortos de trabajo
CN 工装短裤



100% cotton
100% bawełna



245
g/m²



ASH

YATO 	Size / Rozmiar	
YT-80930	S	10
YT-80931	M	10
YT-80932	L	10
YT-80933	L/XL	10
YT-80934	XL	10
YT-80935	XXL	10

EN Working shorts
PL Spodnie robocze krótkie
DE Kurze Arbeitshose
RU Рабочие шорты
CZ Pracovní šortky
HU Munkaruha rövid nadrág
RO Pantaloni scurți de lucru
FR Pantalon de travail court
IT Pantaloni da lavoro corti
ES Pantalónes cortos de trabajo
CN 工装短裤



100% cotton
100% bawełna



245
g/m²



DIM

YATO 	Size / Rozmiar	
YT-80936	S	10
YT-80937	M	10
YT-80938	L	10
YT-80939	L/XL	10
YT-80940	XL	10
YT-80941	XXL	10

EN Working trousers
PL Spodnie robocze
DE Arbeitshose
RU Рабочие брюки
CZ Pracovní kalhoty
HU Munkaruha nadrág
RO Pantaloni de lucru
FR Pantalon de travail
IT Pantalone da lavoro
ES Pantalón de trabajo
CN 工作服



52% polyester, 41% cotton, 7% spandex
52% poliester, 41% bawełna, 7% spandex



350
g/m²



IDONEUS

YATO 	Size / Rozmiar	
YT-79040	S	20
YT-79041	M	20
YT-79042	L	20
YT-79043	XL	20
YT-79044	XXL	20
YT-79045	XXXL	20

EN Softshell trousers
PL Spodnie softshell
DE Softshellhose
RU Брюки софтшелл
CZ Kalhoty softshell
HU Softshell nadrág
RO Pantaloni softshell
FR Pantalon softshell
IT Pantaloni softshell
ES Pantalones softshell
CN 冲锋裤



96% polyester, 4% spandex
96% poliester, 4% spandex



220
g/m²



GAMP

YATO 	Size / Rozmiar	
YT-79420	S	10
YT-79421	M	10
YT-79422	L	10
YT-79423	XL	10
YT-79424	XXL	10
YT-79425	XXXL	10

EN Softshell trousers
PL Spodnie softshell
DE Softshellhose
RU Брюки софтшелл
CZ Kalhoty softshell
HU Softshell nadrág
RO Pantaloni softshell
FR Pantalon softshell
IT Pantaloni softshell
ES Pantalones softshell
CN 冲锋裤



96% polyester, 4% spandex
96% poliester, 4% spandex



260
g/m²



MALLETT

YATO 	Size / Rozmiar	
YT-79430	S	10
YT-79431	M	10
YT-79432	L	10
YT-79433	XL	10
YT-79434	XXL	10
YT-79435	XXXL	10

EN Working trousers
 PL Spodnie robocze
 DE Arbeitshose
 RU Рабочие брюки
 CZ Pracovní kalhoty
 HU Munkaruha nadrág
 RO Pantaloni de lucru
 FR Pantalon de travail
 IT Pantalone da lavoro
 ES Pantalón de trabajo
 CN 工作服



325 g/m²
17
 POCKETS
 KIESZENIE
2

EN Working trousers
 PL Spodnie robocze
 DE Arbeitshose
 RU Рабочие брюки
 CZ Pracovní kalhoty
 HU Munkaruha nadrág
 RO Pantaloni de lucru
 FR Pantalon de travail
 IT Pantalone da lavoro
 ES Pantalón de trabajo
 CN 工作服



325 g/m²
17
 POCKETS
 KIESZENIE
2



71% cotton, 25.5% polyester, 2% viscose, 1.5% spandex
 71% bawełna, 25.5% poliester, 2% wiskoza, 1.5% spandex



71% cotton, 25.5% polyester, 2% viscose, 1.5% spandex
 71% bawełna, 25.5% poliester, 2% wiskoza, 1.5% spandex

YATO	Size / Rozmiar	
YT-79070	S	10
YT-79071	M	10
YT-79072	L	10
YT-79073	L/XL	10
YT-79074	XL	10
YT-79075	XXL	10

YATO	Size / Rozmiar	
YT-79050	S	10
YT-79051	M	10
YT-79052	L	10
YT-79053	L/XL	10
YT-79054	XL	10
YT-79055	XXL	10

EN Working trousers
 PL Spodnie robocze
 DE Arbeitshose
 RU Рабочие брюки
 CZ Pracovní kalhoty
 HU Munkaruha nadrág
 RO Pantaloni de lucru
 FR Pantalon de travail
 IT Pantalone da lavoro
 ES Pantalón de trabajo
 CN 工作服



325 g/m²
17
 POCKETS
 KIESZENIE
2

EN Working trousers
 PL Spodnie robocze
 DE Arbeitshose
 RU Рабочие брюки
 CZ Pracovní kalhoty
 HU Munkaruha nadrág
 RO Pantaloni de lucru
 FR Pantalon de travail
 IT Pantalone da lavoro
 ES Pantalón de trabajo
 CN 工作服



300 g/m²
14
 POCKETS
 KIESZENIE
2



71% cotton, 25.5% polyester, 2% viscose, 1.5% spandex
 71% bawełna, 25.5% poliester, 2% wiskoza, 1.5% spandex



97% cotton, 3% spandex
 97% bawełna, 3% spandex

REBAR

YATO	Size / Rozmiar	
YT-79060	S	10
YT-79061	M	10
YT-79062	L	10
YT-79063	L/XL	10
YT-79064	XL	10
YT-79065	XXL	10

YATO	Size / Rozmiar	
YT-79360	S	10
YT-79361	M	10
YT-79362	L	10
YT-79363	L/XL	10
YT-79364	XL	10
YT-79365	XXL	10

EN Stretch work trousers
 PL Spodnie z elastanem
 DE Hose mit Elasthan
 RU Брюки с эластаном
 CZ Kalhoty s elastanem
 HU Elasztános nadrág
 RO Pantaloni de lucru elastici
 FR Pantaloni élasthane
 IT Pantaloni con elastan
 ES Pantalones con elastano
 CN 冲锋裤



240 g/m²
9
 STRETCH
 POCKETS
 KIESZENIE
2

EN Working trousers
 PL Spodnie robocze
 DE Arbeitshose
 RU Рабочие брюки
 CZ Pracovní kalhoty
 HU Munkaruha nadrág
 RO Pantaloni de lucru
 FR Pantalon de travail
 IT Pantalone da lavoro
 ES Pantalón de trabajo
 CN 工作服



275 g/m²
9
 POCKETS
 KIESZENIE
2

64% polyester, 34% cotton, 2% elastane
 64% poliester, 34% bawełna, 2% elastan



65% polyester, 35% cotton
 65% poliester, 35% bawełna



ONYX

DUERO

YATO	Size / Rozmiar	
YT-79440	S	10
YT-79441	M	10
YT-79442	L	10
YT-79443	XL	10
YT-79444	XXL	10
YT-79445	XXXL	10

YATO	Size / Rozmiar	
YT-8025	S (EU) / 34 (US)	10
YT-8026	M (EU) / 36 (US)	10
YT-8027	L (EU) / 38 (US)	20
YT-8028	XL (EU) / 40 (US)	10
YT-8029	XXL (EU) / 42 (US)	10

EN Working trousers
PL Spodnie robocze
DE Arbeitshose
RU Рабочие брюки
CZ Pracovní kalhoty
HU Munkaruha nadrág
RO Pantaloni de lucru
FR Pantalon de travail
IT Pantalone da lavoro
ES Pantalón de trabajo
CN 工作服



65% polyester, 35% cotton
65% poliester, 35% bawełna



DAV

YATO	Size / Rozmiar	
YT-80285	S (EU) / 34 (US)	10
YT-80286	M (EU) / 36 (US)	10
YT-80287	L (EU) / 38 (US)	10
YT-80288	XL (EU) / 40 (US)	10
YT-80289	XXL (EU) / 42 (US)	10

EN Working trousers
PL Spodnie robocze
DE Arbeitshose
RU Рабочие брюки
CZ Pracovní kalhoty
HU Munkaruha nadrág
RO Pantaloni de lucru
FR Pantalon de travail
IT Pantalone da lavoro
ES Pantalón de trabajo
CN 工作服



65% polyester, 35% cotton
65% poliester, 35% bawełna



BASALT

YATO	Size / Rozmiar	
YT-80146	S	10
YT-80147	M	10
YT-80148	L	10
YT-80149	L/XL	10
YT-80150	XL	10
YT-80151	XXL	10

EN Working trousers
PL Spodnie robocze
DE Arbeitshose
RU Рабочие брюки
CZ Pracovní kalhoty
HU Munkaruha nadrág
RO Pantaloni de lucru
FR Pantalon de travail
IT Pantalone da lavoro
ES Pantalón de trabajo
CN 工作服



100% brushed cotton
100% szczotkowana bawełna



COMFY

YATO	Size / Rozmiar	
YT-79240	S	10
YT-79241	M	10
YT-79242	L	10
YT-79243	L/XL	10
YT-79244	XL	10
YT-79245	XXL	10

EN Working trousers
PL Spodnie robocze
DE Arbeitshose
RU Рабочие брюки
CZ Pracovní kalhoty
HU Munkaruha nadrág
RO Pantaloni de lucru
FR Pantalon de travail
IT Pantalone da lavoro
ES Pantalón de trabajo
CN 工作服



100% cotton
100% bawełna



PALEA

YATO	Size / Rozmiar	
YT-80164	S	10
YT-80165	M	10
YT-80166	L	10
YT-80167	L/XL	10
YT-80168	XL	10
YT-80169	XXL	10

EN Working trousers
PL Spodnie robocze
DE Arbeitshose
RU Рабочие брюки
CZ Pracovní kalhoty
HU Munkaruha nadrág
RO Pantaloni de lucru
FR Pantalon de travail
IT Pantalone da lavoro
ES Pantalón de trabajo
CN 工作服



65% polyester, 35% cotton
65% poliester, 35% bawełna



PEGMA

YATO	Size / Rozmiar	
YT-80182	S	10
YT-80183	M	10
YT-80184	L	10
YT-80185	L/XL	10
YT-80186	XL	10
YT-80187	XXL	10

EN Working trousers
PL Spodnie robocze
DE Arbeitshose
RU Рабочие брюки
CZ Pracovní kalhoty
HU Munkaruha nadrág
RO Pantaloni de lucru
FR Pantalon de travail
IT Pantalone da lavoro
ES Pantalón de trabajo
CN 工作服



65% polyester, 35% cotton
65% poliester, 35% bawełna



DORIA

YATO	Size / Rozmiar	
YT-80401	S	10
YT-80402	M	10
YT-80403	L	10
YT-80404	L/XL	10
YT-80405	XL	10
YT-80406	XXL	10

- EN Reflective winter trousers with padding
- PL Spodnie robocze ocieplane, odblaskowe
- DE Warme Warnschutzhose mit Reflektionsstreifen
- RU Утепленные рабочие светоотражающие брюки
- CZ Oteplené pracovní kalhoty reflexní
- HU Bélelt fényvisszaverő munkanadrág
- RO Pantaloni impermeabili reflectorizanti pt. iarnă
- FR Pantalon de travail isolant et réfléchissant
- IT Pantaloni da lavoro imbottiti, ad alta visibilità
- ES Pantalones acolchados de trabajo, reflectantes
- CN 荧光棉长裤



400
g/m²

PU
COATING
POWLOKA

5000
mm

6
POCKETS
KIESZENIE

100% polyester
100% poliester

YATO	Size / Rozmiar	
YT-80955	S (EU) / 34 (US)	10
YT-80956	M (EU) / 36 (US)	10
YT-80957	L (EU) / 38 (US)	10
YT-80958	XL (EU) / 40 (US)	10
YT-80959	XXL (EU) / 42 (US)	10

- EN Working trousers
- PL Spodnie robocze
- DE Arbeitshose
- RU Рабочие брюки
- CZ Pracovní kalhoty
- HU Munkaruha nadrág
- RO Pantaloni de lucru
- FR Pantalon de travail
- IT Pantalone da lavoro
- ES Pantalón de trabajo
- CN 工作服



190
g/m²

9
POCKETS
KIESZENIE

2
PVC

65% polyester, 35% cotton
65% poliester, 35% bawełna



ANDESITE

YATO	Size / Rozmiar	
YT-80906	S	10
YT-80907	M	10
YT-80908	L	10
YT-80909	L/XL	10
YT-80910	XL	10
YT-80911	XXL	10

- EN Work bib pants
- PL Spodnie robocze ogrodniczki
- DE Arbeitsschuhose
- RU Рабочий полукombineзон
- CZ Pracovní kalhoty lačlové
- HU Kertész nadrág
- RO Pantaloni de lucru grădină
- FR Salopette de travail
- IT Salopette da lavoro
- ES Pantalón de trabajo tipo jardinero
- CN 工作服



275
g/m²

11
POCKETS
KIESZENIE

2
PVC

65% polyester, 35% cotton
65% poliester, 35% bawełna



DUERO

YATO	Size / Rozmiar	
YT-8030	S (EU) / 34 (US)	10
YT-8031	M (EU) / 36 (US)	10
YT-8032	L (EU) / 38 (US)	10
YT-8033	XL (EU) / 40 (US)	10
YT-8034	XXL (EU) / 42 (US)	10

- EN Work bib pants
- PL Spodnie robocze ogrodniczki
- DE Arbeitsschuhose
- RU Рабочий полукombineзон
- CZ Pracovní kalhoty lačlové
- HU Kertész nadrág
- RO Pantaloni de lucru grădină
- FR Salopette de travail
- IT Salopette da lavoro
- ES Pantalón de trabajo tipo jardinero
- CN 背带裤



270
g/m²

7
POCKETS
KIESZENIE

2
PVC

65% polyester, 35% cotton
65% poliester, 35% bawełna



DAN

YATO	Size / Rozmiar	
YT-80290	S (EU) / 34 (US)	10
YT-80291	M (EU) / 36 (US)	10
YT-80292	L (EU) / 38 (US)	10
YT-80293	XL (EU) / 40 (US)	10
YT-80294	XXL (EU) / 42 (US)	10



EN Work bib pants
PL Spodnie robocze ogrodniczki
DE Arbeitsslatzhose
RU Рабочий полукомбинезон
CZ Pracovní kalhoty lačlové
HU Kertész nadrág
RO Pantaloni de lucru grădină
FR Salopette de travail
IT Salopette da lavoro
ES Pantalón de trabajo tipo jardinero
CN 背带裤



65% polyester, 35% cotton
65% poliester, 35% bawełna



BASALT

YATO 	Size / Rozmiar	
YT-80152	S	10
YT-80153	M	10
YT-80154	L	10
YT-80155	L/XL	10
YT-80156	XL	10
YT-80157	XXL	10

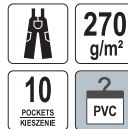

EN Work bib pants
PL Spodnie robocze ogrodniczki
DE Arbeitsslatzhose
RU Рабочий полукомбинезон
CZ Pracovní kalhoty lačlové
HU Kertész nadrág
RO Pantaloni de lucru grădină
FR Salopette de travail
IT Salopette da lavoro
ES Pantalón de trabajo tipo jardinero
CN 背带裤



100% cotton
100% bawełna



PALEA

YATO 	Size / Rozmiar	
YT-80170	S	10
YT-80171	M	10
YT-80172	L	10
YT-80173	L/XL	10
YT-80174	XL	10
YT-80175	XXL	10



EN Work bib pants
PL Spodnie robocze ogrodniczki
DE Arbeitsslatzhose
RU Рабочий полукомбинезон
CZ Pracovní kalhoty lačlové
HU Kertész nadrág
RO Pantaloni de lucru grădină
FR Salopette de travail
IT Salopette da lavoro
ES Pantalón de trabajo tipo jardinero
CN 背带裤



100% brushed cotton
100% szczotkowana bawełna



COMFY

YATO 	Size / Rozmiar	
YT-79250	S	10
YT-79251	M	10
YT-79252	L	10
YT-79253	L/XL	10
YT-79254	XL	10
YT-79255	XXL	10



EN Work bib pants
PL Spodnie robocze ogrodniczki
DE Arbeitsslatzhose
RU Рабочий полукомбинезон
CZ Pracovní kalhoty lačlové
HU Kertész nadrág
RO Pantaloni de lucru grădină
FR Salopette de travail
IT Salopette da lavoro
ES Pantalón de trabajo tipo jardinero
CN 背带裤



65% polyester, 35% cotton
65% poliester, 35% bawełna



PEGMA

YATO 	Size / Rozmiar	
YT-80188	S	10
YT-80189	M	10
YT-80190	L	10
YT-80191	L/XL	10
YT-80192	XL	10
YT-80193	XXL	10

EN Work bib pants
 PL Spodnie robocze ogrodniczki
 DE Arbeitsslatzhose
 RU Рабочий полукombineзон
 CZ Pracovní kalhoty lačlové
 HU Kertész nadrág
 RO Pantaloni de lucru grădină
 FR Salopette de travail
 IT Salopette da lavoro
 ES Pantalón de trabajo tipo jardinero
 CN 背带裤



245
g/m²

7
POCKETS
KIESZENÉ

2
PVC

65% polyester, 35% cotton
 65% poliester, 35% bawelna



DORIA

YATO	Size / Rozmiar	
YT-80407	S	10
YT-80408	M	10
YT-80409	L	10
YT-80410	L/XL	10
YT-80411	XL	10
YT-80412	XXL	10

EN Work bib pants
 PL Spodnie robocze ogrodniczki
 DE Arbeitsslatzhose
 RU Рабочий полукombineзон
 CZ Pracovní kalhoty lačlové
 HU Kertész nadrág
 RO Pantaloni de lucru grădină
 FR Salopette de travail
 IT Salopette da lavoro
 ES Pantalón de trabajo tipo jardinero
 CN 背带裤



190
g/m²

13
POCKETS
KIESZENÉ

2
PVC

65% polyester, 35% cotton
 65% poliester, 35% bawelna



ANDESITE

YATO	Size / Rozmiar	
YT-80912	S	10
YT-80913	M	10
YT-80914	L	10
YT-80915	L/XL	10
YT-80916	XL	10
YT-80917	XXL	10

EN Reflective winter bib pants with padding
 PL Spodnie robocze ogrodniczki ocieplane, odblaskowe
 DE Warme Warnschutzhose mit Hosenträger und Reflektionsstreifen
 RU Утепленные брюки на bretелях с увеличенной видимостью
 CZ Oteplené kalhoty na šlích se zvýšenou viditelností
 HU Növelt láthatóságú bélelt vállpántos nadrág
 RO Pantaloni impermeabili reflectorizanti pt. iarnă
 FR Pantalon isolant à bretelles avec augmentation de la visibilité
 IT Pantaloni con pettorale imbottiti, alla visibilità aumentata
 ES Pantalones acolchados de tirantes, visibilidad elevada
 CN 荧光棉背带裤



400
g/m²

PU
COATING
POWLOKA

5000 mm

7
POCKETS
KIESZENÉ

100% polyester
 100% poliester

YATO	Size / Rozmiar	
YT-80960	S (EU) / 34 (US)	10
YT-80961	M (EU) / 36 (US)	10
YT-80962	L (EU) / 38 (US)	10
YT-80963	XL (EU) / 40 (US)	10
YT-80964	XXL (EU) / 42 (US)	10

EN Rainsuit
 PL Komplet przeciwdeszczowy
 DE Regenschutz-Set
 RU Противодждевой набор
 CZ Průhledšťová sada
 HU Esővédő szett
 RO Costum impermeabil
 FR Kit anti pluie
 IT Tuta impermeabile
 ES Juego impermeable
 CN 男式雨衣套装



200
g/m²

PU
COATING
POWLOKA

3
POCKETS
KIESZENÉ

2
PVC

100% polyester
 100% poliester



YATO	Size / Rozmiar	
YT-79710	S	10
YT-79711	M	10
YT-79712	L	10
YT-79713	XL	10
YT-79714	XXL	10
YT-79715	XXXL	10

Memo

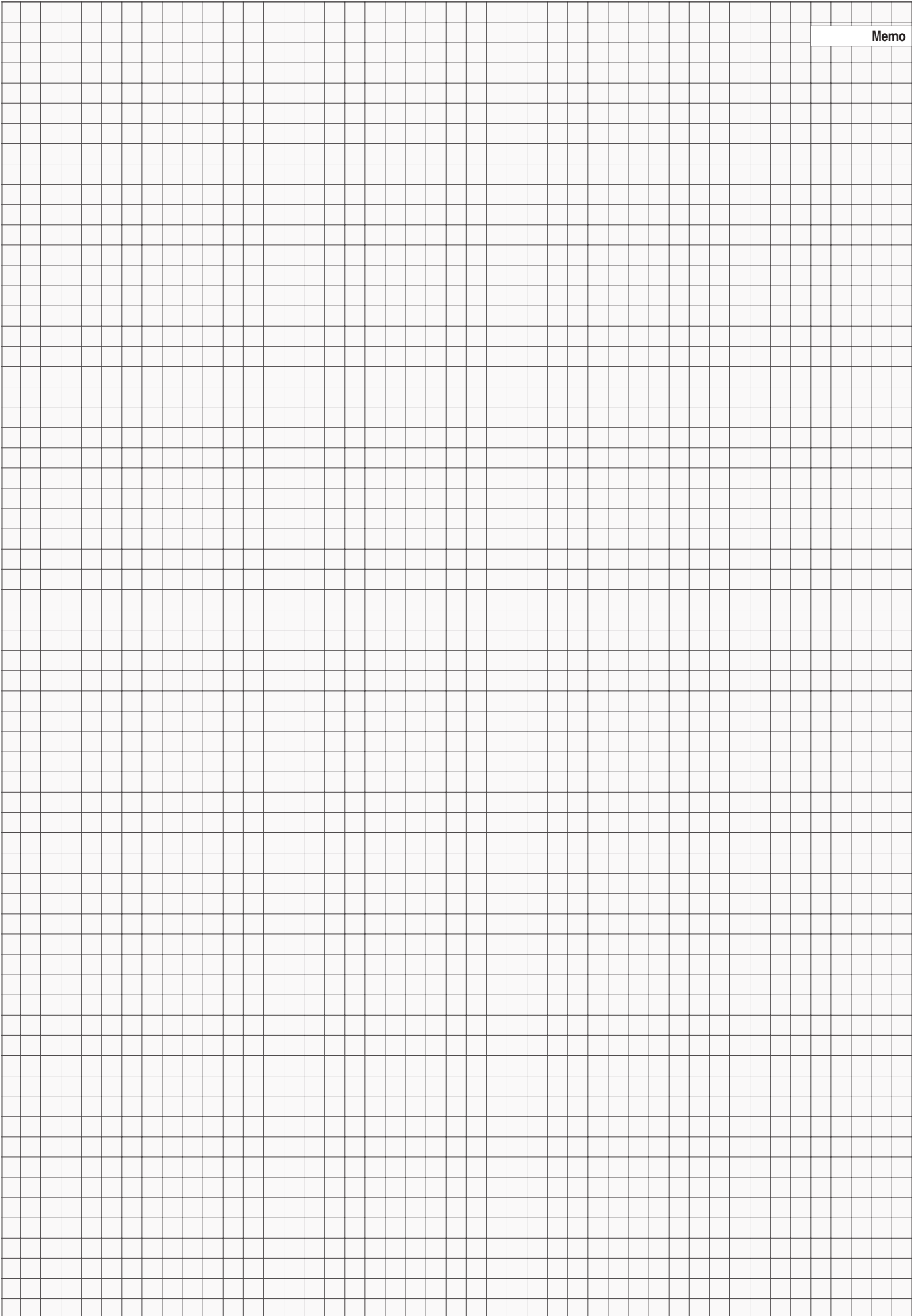

21

Electric products Artykuły elektryczne



Ceiling & wall lamps
Oprawy sufitowe i ścienne

602



Flashlights
Latarki

611-616



Floodlights & accessories
Naświetlacze i akcesoria

602-606



Infrared heaters & accessories
Promienniki podczerwieni i akcesoria

616-617



Solar lamps
Oprawy solarne

606



Travel adapters
Adaptory podróżne

617



Workshop lightning
Oświetlenie warsztatowe

607-611



Extension cords
Przedłużacze elektryczne

618-619



EN Wall lamp
 PL Lampa naścienna
 DE Wandleuchte
 RU Светильник настенный
 CZ Nástěnné svítidlo
 HU Fali lámpa
 RO Lampă de perete
 FR Applique
 IT Lampada da parete
 ES Lámpara de pared
 CN 户外壁灯

220-240V~50Hz
GU10
 max. 35W
IP44



A++
A+
A

Outdoor lamp
 Lampa zewnętrzna

YATO
YT-81900 20

EN Wall lamp
 PL Lampa naścienna
 DE Wandleuchte
 RU Светильник настенный
 CZ Nástěnné svítidlo
 HU Fali lámpa
 RO Lampă de perete
 FR Applique
 IT Lampada da parete
 ES Lámpara de pared
 CN 户外壁灯

220-240V~50Hz
GU10
 max. 35W
IP44



A++
A+
A

Outdoor lamp
 Lampa zewnętrzna

YATO
YT-81901 20

EN Wall lamp
 PL Lampa naścienna
 DE Wandleuchte
 RU Светильник настенный
 CZ Nástěnné svítidlo
 HU Fali lámpa
 RO Lampă de perete
 FR Applique
 IT Lampada da parete
 ES Lámpara de pared
 CN 户外壁灯

220-240V~50Hz
GU10
 max. 2x35W
IP44



A++
A+
A

Outdoor lamp
 Lampa zewnętrzna

YATO
YT-81902 12

EN Wall lamp
 PL Lampa naścienna
 DE Wandleuchte
 RU Светильник настенный
 CZ Nástěnné svítidlo
 HU Fali lámpa
 RO Lampă de perete
 FR Applique
 IT Lampada da parete
 ES Lámpara de pared
 CN 户外壁灯

220-240V~50Hz
GU10
 max. 2x35W
IP44



A++
A+
A

Outdoor lamp
 Lampa zewnętrzna

YATO
YT-81903 12

EN Garden light with spike
 PL Reflektor ogrodowy ze szpikulcem
 DE Gartenleuchte mit Erdspiess
 RU Светильник садовый
 CZ Zahradní svítidlo
 HU Kerti tűske fényvető
 RO Lampă gradină cu pivot
 FR Lampe de jardin
 IT Lampada da giardino con punta
 ES Reflector de jardín
 CN 地插灯

220-240V~50Hz
GU10
 max. 35W
AI
IP54



Outdoor lamp
 Lampa zewnętrzna



A++
A+
A

YATO
YT-81775 8

EN LED floodlight
 PL Reflektor LED
 DE LED-Arbeitsleuchte
 RU Светодиодный прожектор
 CZ LED reflektor
 HU Diódás reflektor
 RO Reflector LED
 FR Projecteur LED
 IT Riflettore LED
 ES Reflector LED
 CN LED投光灯

230V~50/60Hz
10 W
950 lm
6500K

IP65



SMD
LED

E **A↑G**

YATO
YT-81821 20

EN LED floodlight
 PL Reflektor LED
 DE LED-Arbeitsleuchte
 RU Светодиодный прожектор
 CZ LED reflektor
 HU Diódás reflektor
 RO Reflector LED
 FR Projecteur LED
 IT Riflettore LED
 ES Reflector LED
 CN LED投光灯

230V~50/60Hz
20 W
1900 lm
6500K

IP65



SMD
LED

E **A↑G**

YATO
YT-818231 16

EN LED floodlight
 PL Reflektor LED
 DE LED-Arbeitsleuchte
 RU Светодиодный прожектор
 CZ LED reflektor
 HU Diódás reflektor
 RO Reflector LED
 FR Projecteur LED
 IT Riflettore LED
 ES Reflector LED
 CN LED投光灯

230V~50/60Hz
30 W
2850 lm
6500K

IP65



SMD
LED

E **A↑G**

YATO
YT-818241 10

EN LED floodlight
 PL Reflektor LED
 DE LED-Arbeitsleuchte
 RU Светодиодный прожектор
 CZ LED reflektor
 HU Diódás reflektor
 RO Reflector LED
 FR Projecteur LED
 IT Riflettore LED
 ES Reflector LED
 CN LED投光灯

230V~50/60Hz
50 W
4750 lm
6500K

IP65



SMD
LED

E **A↑G**

YATO
YT-818251 8

EN LED floodlight with motion sensor
PL Reflektor LED z czujnikiem ruchu
DE LED-Leuchte mit Bewegungsmelder
RU Светодиодный прожектор с датчиком движения
CZ LED reflektor se snímačem pohybu
HU Diódás reflektor mozgásérzékelővel
RO Reflector diodă cu senzor de mișcare
FR Projecteur LED avec détecteur de mouvement
IT Riflettore LED con sensore
ES Reflector de diodos con sensor de movimiento
CN 泛光灯

230V~
50/60Hz

20 W

1900 lm

6500K

10±2m

SMD LED

30000h

IP54



E A ↑ G



YATO
YT-818271

16

EN LED floodlight with motion sensor
PL Reflektor LED z czujnikiem ruchu
DE LED-Leuchte mit Bewegungsmelder
RU Светодиодный прожектор с датчиком движения
CZ LED reflektor se snímačem pohybu
HU Diódás reflektor mozgásérzékelővel
RO Reflector diodă cu senzor de mișcare
FR Projecteur LED avec détecteur de mouvement
IT Riflettore LED con sensore
ES Reflector de diodos con sensor de movimiento
CN 泛光灯

230V~
50/60Hz

50 W

4750 lm

6500K

10±2m

SMD LED

30000h

IP54



E A ↑ G

YATO
YT-818291

8

EN LED floodlight
PL Reflektor LED
DE LED-Arbeitsleuchte
RU Светодиодный прожектор
CZ LED reflektor
HU Diódás reflektor
RO Reflector LED
FR Projecteur LED
IT Riflettore LED
ES Reflector LED
CN LED投光灯

230V~
50/60Hz

30 W

2850 lm

6500K

30000h

IP65

CABLE
H05RN-F
KABEL

1.5m



E A ↑ G

YATO
YT-818381

10

EN LED floodlight
PL Reflektor LED
DE LED-Arbeitsleuchte
RU Светодиодный прожектор
CZ LED reflektor
HU Diódás reflektor
RO Reflector LED
FR Projecteur LED
IT Riflettore LED
ES Reflector LED
CN LED投光灯

230V~
50/60Hz

50 W

4750 lm

6500K

30000h

IP65

CABLE
H05RN-F
KABEL

1.5m



E A ↑ G

YATO
YT-818391

8

EN Hybrid floodlight
PL Reflektor sieciowo-akumulatorowy
DE Netz- und Akku-Scheinwerfer
RU Аккумуляторно-сетевой прожектор
CZ Síťovo-bateriový reflektor
HU Hálózati-akkumulátoros reflektor
RO Proiector hibrid
FR Projecteur LED avec trépied
IT Faro LED a batteria
ES Lámpara reflector de pie con cable y batería
CN 三脚架工作灯



CRI
70

7.4 V
4000mAh
Li-Ion

5000 lm

6h

1-5h

1.8
0.96
m

CABLE
H05RN-F
KABEL

2x
0.75
mm²

5m

SMD LED

YATO
YT-81811

2

EN LED floodlight with tripod
 PL Reflektor LED na stojaku
 DE LED-Stativ-Leuchte
 RU Светодиодный прожектор на стойке
 CZ LED reflektor na stojanu
 HU Állványos diódás reflektor
 RO Reflector diodă pe stativ
 FR Projecteur LED sur trépied
 IT Faro LED con treppiede
 ES Reflector de diodos con tripie
 CN 带支架投光灯



230V~
50/60Hz

20 W

1900
lm

6500K

30000 h

1,2
0,6
m

IP65

CABLE
H05RN-F
KABEL

2 m



YATO 
 YT-818141

6

EN LED floodlight with tripod
 PL Reflektor LED na stojaku
 DE LED-Stativ-Leuchte
 RU Светодиодный прожектор на стойке
 CZ LED reflektor na stojanu
 HU Állványos diódás reflektor
 RO Reflector diodă pe stativ
 FR Projecteur LED sur trépied
 IT Faro LED con treppiede
 ES Reflector de diodos con tripie
 CN 带支架投光灯



230V~
50/60Hz

30 W

2850
lm

6500K

30000 h

1,2
0,6
m

IP65

CABLE
H05RN-F
KABEL

2 m



YATO 
 YT-818161

6

EN LED floodlight with tripod
 PL Reflektor LED na stojaku
 DE LED-Stativ-Leuchte
 RU Светодиодный прожектор на стойке
 CZ LED reflektor na stojanu
 HU Állványos diódás reflektor
 RO Reflector diodă pe stativ
 FR Projecteur LED sur trépied
 IT Faro LED con treppiede
 ES Reflector de diodos con tripie
 CN 带支架投光灯



230V~
50/60Hz

20W x2

1900lm
x2

6500K

30000 h

1,2
0,6
m

IP65

CABLE
H05RN-F
KABEL

2 m



YATO 
 YT-818151

4

EN LED floodlight with tripod
 PL Reflektor LED na stojaku
 DE LED-Stativ-Leuchte
 RU Светодиодный прожектор на стойке
 CZ LED reflektor na stojanu
 HU Állványos diódás reflektor
 RO Reflector diodă pe stativ
 FR Projecteur LED sur trépied
 IT Faro LED con treppiede
 ES Reflector de diodos con tripie
 CN 带支架投光灯



230V~
50/60Hz

30W x2

2850lm
x2

6500K

30000 h

1,2
0,6
m

IP65

CABLE
H05RN-F
KABEL

2 m



YATO 
 YT-818171

4

EN Workshop LED lamp
PL Lampa warsztatowa LED
DE LED Arbeitsleuchte
RU Светодиодная лампа для мастерской
CZ LED pracovní lampa
HU LED szerezőlámpa
RO Lampa cu LED pt. atelier
FR Lanterne d'atelier LED
IT Lampada da lavoro LED
ES Lámpara de trabajo LED
CN 工作灯



220-240V-50Hz
50 W
3000 W
3800 lm
5000K
CRI 80
360°
IP44
30000h
1.5 m

SMD
LED

G A ↑ G

YATO
YT-08495

4

EN Workshop LED lamp
PL Lampa warsztatowa LED
DE LED Arbeitsleuchte
RU Светодиодная лампа для мастерской
CZ LED pracovní lampa
HU LED szerezőlámpa
RO Lampa cu LED pt. atelier
FR Lanterne d'atelier LED
IT Lampada da lavoro LED
ES Lámpara de trabajo LED
CN 工作灯



220-240V-50Hz
100 W
3000 W
7500 lm
5000K
CRI 80
360°
IP44
30000h
1.5 m

SMD
LED

G A ↑ G

YATO
YT-08496

4

EN Cordless floodlight
PL Akumulatorowa lampa robocza
DE Akku-Lampe
RU Аккумуляторная лампа
CZ Dobíjecí lampa
HU Újratölthető lámpa
RO Lampa reincarcabila
FR Projecteur sans-fil
IT Lampada da lavoro a batteria
ES Lámpara recargable a batería
CN 锂电LED工作灯

• 2 lighting modes: 50%, 100%
• 2 tryby świecenia: 50%, 100%



18 V
Li-Ion
1600 lm
2
LIGHTING MODES
TRYBY ŚWIECENIA
180°
METAL FRAME
METALOWA RAMKA
TRANSPORT HANDLE
UCHWYT TRANSPORTOWY

A++
A+
A

Battery not included
Obrze Akku / Bez akumulatora
Bez baterii / Bez akui
Akumulator nélkül
Fără baterie / Sans batterie
Senza batteria / Sin batería
没有电池

18V
Li-Ion

YATO
YT-82961

[V d.c.]
18

6

EN LED rechargeable floodlight
PL Reflektor LED akumulatorowy
DE Akku-LED-Arbeitsleuchte
RU Светодиодный аккумуляторный прожектор
CZ LED bateriový reflektor
HU Újratölthető reflektor LED

RO Reflektor LED pe acumulatori
FR Projecteur a LED rechargeable
IT Riflettore LED a batteria
ES Reflector recargable LED
CN 充电工作灯



5W
3.7 V
2000mAh
Li-Ion
300 lm
7000K
5.5h
3.5-4h
5
LIGHTING MODES
TRYBY ŚWIECENIA
IP54
USB
BATTERY CHARGER
ŁADOWNIK BATERII

COB
LED



A++
A+
A

YATO
YT-81819

40

EN LED rechargeable floodlight
PL Reflektor LED akumulatorowy
DE Akku-LED-Arbeitsleuchte
RU Светодиодный аккумуляторный прожектор
CZ LED bateriový reflektor
HU Újratölthető reflektor LED
RO Reflektor LED pe acumulatori
FR Projecteur a LED rechargeable
IT Riflettore LED a batteria
ES Reflector recargable LED
CN 充电工作灯

A++
A+
A



10 W
3.7 V
4400mAh
Li-Ion
800 lm
6000K
5.5h
2.5h
4400 mAh
Micro USB

COB
LED

EN LED floodlight
PL Reflektor LED
DE LED-Arbeitsleuchte
RU Светодиодный прожектор
CZ LED reflektor
HU Diódás reflektor
RO Reflektor LED
FR Projecteur LED
IT Riflettore LED
ES Reflector LED
CN LED投光灯

A++
A+
A



10 W
6V
680 lm
4x AA
3
LIGHTING MODES
TRYBY ŚWIECENIA
PA6

COB
LED

• 3 lighting modes: 100%, 30%, strobe
• 3 tryby świecenia: 100%, 30%, pulsowanie

YATO
YT-81820

6/12

YATO
YT-81821

8/16

EN Rechargeable worklight
PL Lampa warsztatowa akumulatorowa
DE Akku-Werkstattleuchte
RU Аккумуляторная рабочая лампа
CZ Akumulátorová dienská lampa
HU Akkumulátoros műhelylámpa
RO Lampa de lucru reincarcabila
FR Kit éclairage mécanicien
IT Lampada officina a batteria
ES linterna para taller recargable
CN 三合一手电筒组套



3 in 1
3 w 1

4h
1m

IP54

USB
CABLE KABEL

POWER
LED



YATO

YT-08521



10

EN Workshop LED battery lamp
PL Diodowa lampa warsztatowa akumulatorowa
DE LED Akku-Werkstattlampe
RU Светодиодная беспроводная лампа
CZ Aku pracovní LED svítidla
HU Akkumulátoros LED szerelőlámpa
RO Lampa portabila cu acumulator leduri
FR Lampe d'inspection LED rechargeable
IT Lampada LED ricaricabile per officina
ES Lámpara de trabajo LED recargable
CN 可充电工作灯



CRI 95

5W

3.7 V
2600mAh
Li-Ion

400 lm

4500K

4h

4h
IP65

IK07

x1
HOOK HAK

COB
LED

A++
A+
A

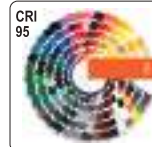

YATO

YT-08509



12

EN Workshop lamp UV
PL Lampa warsztatowa UV
DE UV-Werkstattleuchte
RU УФ лампа для мастерской
CZ Dienská lampa UV
HU UV műhelylámpa
RO Lampa UV atelier
FR Lampe d'atelier UV
IT Lampada da officina UV
ES Lámpara UV de taller
CN 工作灯-用于检泄露



5W

UV

390-405 nm

3.7 V
2600mAh
Li-Ion

4h

4.5h

IP65

IK07

x1
HOOK HAK

USB
CHARGING
LADOWANIE

UV
LED



YATO

YT-08500



12

EN Workshop LED battery lamp
PL Diodowa lampa warsztatowa akumulatorowa
DE LED Akku-Werkstattlampe
RU Светодиодная беспроводная лампа
CZ Aku pracovní LED svítidla
HU Akkumulátoros LED szerelőlámpa
RO Lampa portabila cu acumulator leduri
FR Lampe d'inspection LED rechargeable
IT Lampada LED ricaricabile per officina
ES Lámpara de trabajo LED recargable
CN 可充电工作灯



FRONT LIGHT
LATARKA

1+1
LED

3.7 V
3600mAh
Li-Ion

180 lm

230V-50Hz
BATTERY CHARGER
LADOWANIE

12V
BATTERY CHARGER
LADOWANIE

4h

2 LED
3h

x1
HOOK HAK

COB
LED

A++
A+
A



YATO

YT-08502



10

- EN Portable floodlight with speaker
- PL Reflektor przenośny z głośnikiem
- DE Tragbarer Scheinwerfer mit Lautsprecher
- RU Переносной звуковой прожектор
- CZ Přenosný reflektor s reproduktorem
- HU Hordozható reflektor hangszóróval
- RO Projector portabil cu difuzor
- FR Projecteur LED portable avec haut-parleur
- IT Proiettore portatile con altoparlante
- ES Reflector portátil con altavoz
- CN 蓝牙音响灯



15W x2	3.7 V 440mAh Li-Ion	2000 lm
5/16" 8 mm	6 LIGHTING MODES TÍPUSZÁLLÁS	5h
2.5-12h	4400 mAh	IP44
COB LED	USB BATTERY CHARGER LADÓVÁRKA	

Compatible with YT-81809
Kompatybilny z YT-81809



YATO YT-81808 24

- EN Aluminium tripod
- PL Statyw aluminiowy
- DE Aluminium-Stativ
- RU Алюминиевый штатив
- CZ Hliníkový statív
- HU Alumínium állvány
- RO Tripied aluminiu
- FR Trépied en aluminium
- IT Tripode in alluminio
- ES Tripode de aluminio
- CN 三角架



100 33.5 cm	5/16" 8 mm
AI	ANTI-SLIP PADS ANTI- POŚLIZGOWE PODKŁADKI

For YT-81808
Dla YT-81808

YATO H [mm] YT-81809 335-1000 21

- EN Solar LED floodlight with motion detector
- PL Reflektor solarny LED z czujnikiem ruchu
- DE Solar-Diodenscheinwerfer mit Bewegungsmelder
- RU Настенный светильник на солнечной батарее с датчиком движения
- CZ LED solární reflektor se snímačem pohybu
- HU Napelemes reflektor LED mozgásérzékelővel
- RO Lampă solara cu senzor
- FR LED projecteur solaire avec détecteur de mouvement
- IT Lampada solare a LED con sensore di movimento
- ES LED solar reflector con sensor de movimiento
- CN 带感应太阳能投光灯

4W	3.7 V 220mAh Li-Ion	380 lm	4000K	6h
3h				IP44
SMD LED				



YATO YT-81860 12

- EN Solar LED wall lamp
- PL Lampa ścienna solarna LED
- DE LED Solar-Wandleuchte
- RU Настінний світильник
- CZ LED solární světla
- HU Fali lámpa napelemes LED
- RO Lampă solara pt. perete
- FR Lampe solaire LED
- IT Lampada da parete LED solare
- ES Luz de pared de LED solar
- CN 太阳能感应壁灯

3.7 V 900mAh Li-Ion	120 lm	8h	12h	
			IP65	
SMD LED				



YATO YT-81855 12/48

- EN Solar LED wall lamp
- PL Lampa ścienna solarna LED
- DE LED Solar-Wandleuchte
- RU Настінний світильник
- CZ LED solární světla
- HU Fali lámpa napelemes LED
- RO Lampă solara pt. perete
- FR Lampe solaire LED
- IT Lampada da parete LED solare
- ES Luz de pared de LED solar
- CN 太阳能感应壁灯



SMD LED	3.7 V 900mAh Li-Ion	120 lm	8h
			12h
		3m	IP65

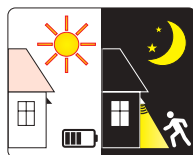

YATO YT-81856 12/48

EN Workshop LED battery lamp
 PL Diodowa lampa warsztatowa akumulatorowa
 DE LED Akku-Werkstattlampe
 RU Светодиодная беспроводная лампа
 CZ Aku pracovní LED svítidla
 HU Akkumulátoros LED szerelőlámpa
 RO Lampa portabila cu acumulator leduri
 FR Lampe d'inspection LED rechargeable
 IT Lampada LED ricaricabile per officina
 ES Lámpara de trabajo LED recargable
 CN 可充电工作灯



FRONT LIGHT
LATARKA

6+1 W

3.7 V
2600mAh
Li-Ion

600/250 lm

4h

1.5-10h

IP54

IK07

x1
HOOK
HAK

USB
BATTERY CHARGER
LADONARKA

x2

COB
LED



YATO
YT-08558

12

EN Workshop LED battery lamp
 PL Diodowa lampa warsztatowa akumulatorowa
 DE LED Akku-Werkstattlampe
 RU Светодиодная беспроводная лампа
 CZ Aku pracovní LED svítidla
 HU Akkumulátoros LED szerelőlámpa
 RO Lampa portabila cu acumulator leduri
 FR Lampe d'inspection LED rechargeable
 IT Lampada LED ricaricabile per officina
 ES Lámpara de trabajo LED recargable
 CN LED工作灯



FRONT LIGHT
LATARKA

5+1 W

3.7 V
2200mAh
Li-Ion

UV

500/250 lm
40 lm

6500K

3h

1.5-11h

IK07
2200 mAh

x1
HOOK
HAK

USB
BATTERY CHARGER
LADONARKA

COB
LED



YATO
YT-08517

6/24

EN Workshop LED battery lamp
 PL Diodowa lampa warsztatowa akumulatorowa
 DE LED Akku-Werkstattlampe
 RU Светодиодная беспроводная лампа
 CZ Aku pracovní LED svítidla
 HU Akkumulátoros LED szerelőlámpa
 RO Lampa portabila cu acumulator leduri
 FR Lampe d'inspection LED rechargeable
 IT Lampada LED ricaricabile per officina
 ES Lámpara de trabajo LED recargable
 CN 可充电LED工作灯

A++
A+
A

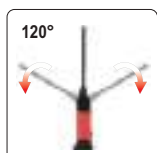
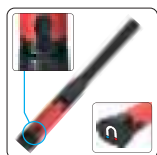

FRONT LIGHT
LATARKA

5+3 W

3.7 V
2600mAh
Li-Ion

600/260 lm

6500K

4h

2.5-5.5h

POLYCARBONATE
DIFFUSER
KLISZ
Z POLIWĘGLANU

USB
BATTERY CHARGER
LADONARKA

COB
LED



YATO
YT-08518

12

EN Workshop LED battery lamp
 PL Diodowa lampa warsztatowa akumulatorowa
 DE LED Akku-Werkstattlampe
 RU Светодиодная беспроводная лампа
 CZ Aku pracovní LED svítidla
 HU Akkumulátoros LED szerelőlámpa
 RO Lampa portabila cu acumulator leduri
 FR Lampe d'inspection LED rechargeable
 IT Lampada LED ricaricabile per officina
 ES Lámpara de trabajo LED recargable
 CN 可充电工作灯

A++
A+
A



FRONT LIGHT
LATARKA

7+3 W

60-600 lm

120 lm

6500K

3.7 V
2600mAh
Li-Ion

4-5h

1.5-16.5h

IP54

LED CHARGE
INDICATOR
WSKAZNIK
NAŁADOWANIA
BATERII

x1
HOOK
HAK

POLYCARBONATE
DIFFUSER
KLISZ
Z POLIWĘGLANU

USB
BATTERY CHARGER
LADONARKA

COB
LED



YATO
YT-08519

20

EN Workshop LED battery lamp
PL Diodowa lampa warsztatowa akumulatorowa
DE LED Akku-Werkstattlampe
RU Светодиодная беспроводная лампа
CZ Aku pracovní LED svítidla
HU Akkumulátoros LED szerelőlámpa
RO Lampa portabila cu acumulator leduri
FR Lampe d'inspection LED rechargeable
IT Lampada LED ricaricabile per officina
ES Lámpara de trabajo LED recargable
CN LED工作灯



EN Workshop LED battery lamp
PL Diodowa lampa warsztatowa akumulatorowa
DE LED Akku-Werkstattlampe
RU Светодиодная беспроводная лампа
CZ Aku pracovní LED svítidla
HU Akkumulátoros LED szerelőlámpa
RO Lampa portabila cu acumulator leduri
FR Lampe d'inspection LED rechargeable
IT Lampada LED ricaricabile per officina
ES Lámpara de trabajo LED recargable
CN 可充电工作灯

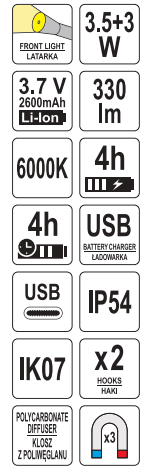
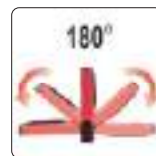

YATO
YT-08527

12

YATO
YT-085081

12

EN Workshop LED battery lamp
PL Diodowa lampa warsztatowa akumulatorowa
DE LED Akku-Werkstattlampe
RU Светодиодная беспроводная лампа
CZ Aku pracovní LED svítidla
HU Akkumulátoros LED szerelőlámpa
RO Lampa portabila cu acumulator leduri
FR Lampe d'inspection LED rechargeable
IT Lampada LED ricaricabile per officina
ES Lámpara de trabajo LED recargable
CN 工作灯

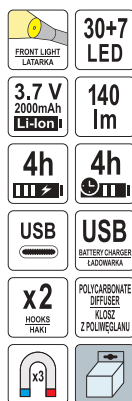

EN Workshop LED battery lamp
PL Diodowa lampa warsztatowa akumulatorowa
DE LED Akku-Werkstattlampe
RU Светодиодная беспроводная лампа
CZ Aku pracovní LED svítidla
HU Akkumulátoros LED szerelőlámpa
RO Lampa portabila cu acumulator leduri
FR Lampe d'inspection LED rechargeable
IT Lampada LED ricaricabile per officina
ES Lámpara de trabajo LED recargable
CN 工作灯



YATO
YT-08507

12

YATO
YT-08504

10

EN Workshop LED battery lamp
 PL Diodowa lampa warsztatowa akumulatorowa
 DE LED Akku-Handleuchte
 RU Светодиодная беспроводная лампа
 CZ Aku pracovní LED svítidla
 HU Akkumulátoros LED szerelőlámpa
 RO Lampa portabilă cu acumulator leduri
 FR Lampe d'inspection LED rechargeable
 IT Lampada LED ricaricabile per officina
 ES Lámpara de trabajo LED recargable
 CN 可充电工作灯





 **30+7 LED**
 FRONT LIGHT
LATARKA

3.7 V 230V-50Hz
1800mAh **Li-Ion** BATTERY CHARGER LADONARKA

12V 45/100 lm
BATTERY CHARGER LADONARKA

8000K 4-5h

3.5-15h x2
HOOKS HAKI

LED

EN Workshop LED battery lamp
 PL Diodowa lampa warsztatowa akumulatorowa
 DE LED Akku-Werkstattlampe
 RU Светодиодная беспроводная лампа
 CZ Aku pracovní LED svítidla
 HU Akkumulátoros LED szerelőlámpa
 RO Lampa portabilă cu acumulator leduri
 FR Lampe d'inspection LED rechargeable
 IT Lampada LED ricaricabile per officina
 ES Lámpara de trabajo LED recargable
 CN 可充电工作灯



 **10+4 W**
FRONT LIGHT
LATARKA

3.7 V 1000/200 lm
3350mAh **Li-Ion**

6500K 4.5h

2-8h 2m

IP65 **IK09**



x2 **USB**
HOOKS HAKI



USB 
CABLE KABEL



COB SMD LED



YATO  **YT-085051**  10

YATO  **YT-08524**  12

EN LED workshop lamp
 PL Diodowa lampa warsztatowa
 DE LED Werkstattlampe
 RU Светодиодный светильник для мастерской
 CZ Montážní lampa LED
 HU LED szerelőlámpa
 RO Lampa cu LED
 FR Lampe d'atelier a LED
 IT Lampada LED per officina
 ES Lámpara de taller LED
 CN LED工作灯



60+1 LED **3.7 V** 1800mAh **Li-Ion**

AC 12V
BATTERY CHARGER LADONARKA BATTERY CHARGER LADONARKA

4h **3h**

x1 
HOOK HAKI



LED

EN LED workshop lamp
 PL Diodowa lampa warsztatowa
 DE LED Werkstattlampe
 RU Светодиодный светильник для мастерской
 CZ Montážní lampa LED
 HU LED szerelőlámpa
 RO Lampa cu LED
 FR Lampe d'atelier a LED
 IT Lampada LED per officina
 ES Lámpara de taller LED
 CN LED工作灯



 **8+1 LED**
FRONT LIGHT
LATARKA

280 lm **3x AA**

9 LED 4h
3 LIGHTING MODES TRYBY SVIETENIA

x1 
HOOK HAKI



SMD LED

A++
A+
A



YATO  **YT-08520**  5/20

YATO  **YT-08513**  50

EN LED workshop lamp
PL Diodowa lampa warsztatowa
DE LED Werkstattlampe
RU Светодиодный светильник для мастерской
CZ Montážní lampa LED
HU LED szerelőlámpa
RO Lampa cu LED
FR Lampe d'atelier a LED
IT Lampada LED per officina
ES Lámpara de taller LED
CN 笔式可充电工作灯



8 LED
80 lm
3x AAA
8 LED 20h

EN LED workshop lamp
PL Diodowa lampa warsztatowa
DE LED Werkstattlampe
RU Светодиодный светильник для мастерской
CZ Montážní lampa LED
HU LED szerelőlámpa
RO Lampa cu LED
FR Lampe d'atelier a LED
IT Lampada LED per officina
ES Lámpara de taller LED
CN 笔式可充电工作灯



COB LED

3W
200 lm
RED FLASH CZERWONE MIGANIE
IP44
3x AAA

EN LED workshop lamp
PL Diodowa lampa warsztatowa
DE LED Werkstattlampe
RU Светодиодный светильник для мастерской
CZ Montážní lampa LED
HU LED szerelőlámpa
RO Lampa cu LED
FR Lampe d'atelier a LED
IT Lampada LED per officina
ES Lámpara de taller LED
CN 笔式可充电工作灯



COB LED

3W
400 lm
RED FLASH CZERWONE MIGANIE
IP44
3x AA

A++
A+
A

SMD LED

YATO
YT-08514 12/72

YATO
YT-08511 20/80

YATO
YT-08522 12/48

EN Multipurpose lamp
PL Lampka wielofunkcyjna
DE Multifunktions-Lampe
RU Многофункциональная лампа
CZ Multifunkční lampička
HU Multifunkciós lámpa
RO Lampa multifunctională
FR Lampe multifonction
IT Lampada multifunzione
ES Lámpara multifuncional
CN 工作灯



COB LED
3W
3.7 V 700mAh Li-Pol
100 lm
7000K
1.5h
2-3h
IP54
USB BATTERY CHARGER LAZDOWARKA

YATO
YT-08516 15/60

EN Under bonnet work lamp
PL Lampka do oświetlenia komory silnika
DE Motorhauben-Leuchte
RU Лампа освещения моторного отсека

CZ Dílenská lampka pro osvětlení motorového prostoru
HU Motorér-megvilágító lámpa
RO Lampă de lucru sub capotă
FR Lampe pour compartiment moteur

IT Lampada sottocofano
ES Lámpara para capó de coche
CN 引擎盖检修灯

LED
120 LED
60 LED
120 LED
7.4 V 1800mAh Li-Ion
AC BATTERY CHARGER LAZDOWARKA
12V BATTERY CHARGER LAZDOWARKA
750 lm
4.5-5h
3.5-8h
x2 HOOKS PART

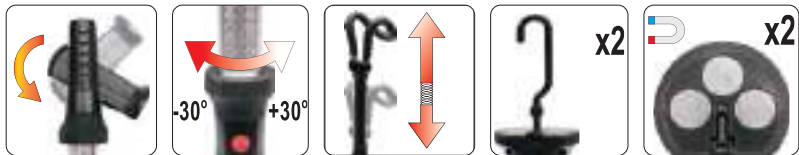

YATO
YT-08529 4

EN UV LED flashlight and glasses set
PL Zestaw latarka UV LED i okulary
DE UV LED Taschenlampe mit UV Schutzbrille
RU Комплект для проверки утечек хладагента - УФ фонарь с очками
CZ UV LED svítilna + brýle
HU UV LED zseblámpa + szemüveg
RO Set lanternă UV LED și ochelari
FR UV LED lampe de poche avec lunettes
IT Lampada UV LED con occhiali
ES UV LED linterna con gafas para
CN 手电筒



51 LED
UV
395 nm
3x AAA

UV LED

YATO
YT-08581 40

EN UV LED flashlight and glasses set
PL Zestaw latarka UV LED i okulary
DE UV LED-Taschenlampe mit UV Schutzbrille
RU Комплект для проверки утечек хладагента - УФ фонарь с очками
CZ UV LED svítilna + brýle
HU UV LED zseblámpa + szemüveg
RO Set lanternă UV LED și ochelari
FR UV LED lampe de poche avec lunettes
IT Lampada UV LED con occhiali
ES UV LED linterna con gafas para
CN 紫外线手电筒和防护眼镜



100 LED
UV
395 nm
6x AA

UV LED

YATO
YT-08582 12

EN UV LED flashlight and glasses set
 PL Zestaw latarka UV LED i okulary
 DE UV LED-Taschenlampe mit UV Schutzbrille
 RU Комплект для проверки утечек хладогента - УФ фонарь с очками
 CZ UV LED svítilna + brýle
 HU UV LED zseblámpa + szemüveg
 RO Set lanternă UV LED și ochelari
 FR UV LED lampe de poche avec lunettes
 IT Lampada UV LED con occhiali
 ES UV LED linterna con gafas para
 CN 紫外线手电筒和防护眼镜

1W UV 395 nm 3.7 V 1500mAh Li-Ion
 6-8h 3.5-4h ZOOM Micro USB



UV LED

YATO		
YT-08587		12

EN UV LED flashlight and glasses set
 PL Zestaw latarka UV LED i okulary
 DE UV LED-Taschenlampe mit UV Schutzbrille
 RU Комплект для проверки утечек хладогента - УФ фонарь с очками
 CZ UV LED svítilna + brýle
 HU UV LED zseblámpa + szemüveg
 RO Set lanternă UV LED și ochelari
 FR UV LED lampe de poche avec lunettes
 IT Lampada UV LED con occhiali
 ES UV LED linterna con gafas para
 CN 紫外线手电筒和防护眼镜

3W UV 395 nm 3.7 V 1500mAh Li-Ion
 6-8h 3.5-4h FLASH MIGNANIE Micro USB



UV LED

YATO		
YT-08588		12

EN LED flashlight
 PL Latarka LED
 DE LED Taschenlampe
 RU Светодиодный фонарь
 CZ LED svítilna
 HU LED zseblámpa
 RO Lanternă cu LED
 FR Lampe torche LED
 IT Torcia LED
 ES Linterna LED
 CN 手电筒



FRONT LIGHT LATARKA 2W 200 lm IPX4 IK07 3x AAA x1 HOOK HAK

POWER SMD LED

YATO	[W]	[lm]	
YT-08555	2	200 / 70 / 45	50

EN LED flashlight
 PL Latarka LED
 DE LED Taschenlampe
 RU Светодиодный фонарь
 CZ LED svítilna
 HU LED zseblámpa
 RO Lanternă cu LED
 FR Lampe torche LED
 IT Torcia LED
 ES Linterna LED
 CN 手电筒



FRONT LIGHT LATARKA 5W 3.7 V 1500mAh Li-Po 500 lm 3h 2-9h IPX4 1500 mAh IK07 x1 HOOK HAK

USB BATTERY CHARGER ŁADOWNIKA x2

POWER SMD LED

YATO	[W]	[lm]	
YT-08556	5+1	500 / 200 / 60	50

EN LED flashlight
 PL Latarka LED
 DE LED Taschenlampe
 RU Светодиодный фонарь
 CZ LED svítilna
 HU LED zseblámpa
 RO Lanternă cu LED
 FR Lampe torche LED
 IT Torcia LED
 ES Linterna LED
 CN 手电筒



FRONT LIGHT LATARKA 5W 3.7 V 2000mAh Li-FePO4 500 lm 4h 2h 30' - 5h 20' IP54 IK07 USB BATTERY CHARGER ŁADOWNIKA

COB SMD LED

YATO	[W]	[lm]	
YT-08557	5+0.9	500 / 250 / 90	50

EN LED flashlight
 PL Latarka LED
 DE LED Taschenlampe
 RU Светодиодный фонарь
 CZ LED svítilna
 HU LED zseblámpa
 RO Lanternă cu LED
 FR Lampe torche LED
 IT Torcia LED
 ES Linterna LED
 CN 手电筒



5W UV 3.7 V 2000mAh Li-Ion 200/300 lm 7000K 5.5h 2-3h IP54 USB BATTERY CHARGER ŁADOWNIKA

COB LED

YATO	[W]	[lm]	
YT-08580	5	200 / 300	50

EN LED flashlight
PL Latarka LED
DE LED Taschenlampe
RU Светодиодный фонарь
CZ LED svítilna
HU LED zseblámpa
RO Lanterna cu LED
FR Lampe torche LED
IT Torcia LED
ES Linterna LED
CN 手电筒

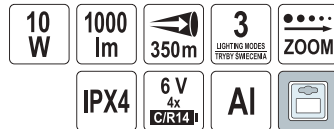

POWER
LED

YATO 	[W]	[lm]	
YT-08567	10	1000	8/16

EN LED flashlight
PL Latarka LED
DE LED Taschenlampe
RU Светодиодный фонарь
CZ LED svítilna
HU LED zseblámpa
RO Lanterna cu LED
FR Lampe torche LED
IT Torcia LED
ES Linterna LED
CN 手电筒

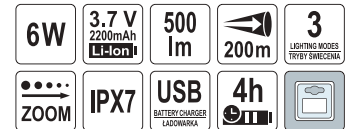



POWER
LED

YATO 	[W]	[lm]	
YT-08568	6	500	6/24

EN LED flashlight
PL Latarka LED
DE LED Taschenlampe
RU Светодиодный фонарь
CZ LED svítilna
HU LED zseblámpa
RO Lanterna cu LED
FR Lampe torche LED
IT Torcia LED
ES Linterna LED
CN 手电筒





POWER
LED

YATO 	[W]	[lm]	
YT-08569	5	350	12/96

EN LED flashlight
PL Latarka LED
DE LED Taschenlampe
RU Светодиодный фонарь
CZ LED svítilna
HU LED zseblámpa
RO Lanterna cu LED
FR Lampe torche LED
IT Torcia LED
ES Linterna LED
CN 手电筒



POWER
LED

YATO 	[W]	[lm]	
YT-08559	10	900	30

- Bottle opener
- Emergency hammer
- Otwieracz do butelek
- Młotek awaryjny do szyb

EN LED flashlight
PL Latarka LED
DE LED Taschenlampe
RU Светодиодный фонарь
CZ LED svítilna
HU LED zseblámpa
RO Lanterna cu LED
FR Lampe torche LED
IT Torcia LED
ES Linterna LED
CN 手电筒

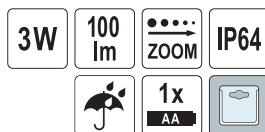

POWER
LED

YATO 	[W]	[lm]	
YT-08571	3	100	24/96

EN LED flashlight
PL Latarka LED
DE LED Taschenlampe
RU Светодиодный фонарь
CZ LED svítilna
HU LED zseblámpa

RO Lanterna cu LED
FR Lampe torche LED
IT Torcia LED
ES Linterna LED
CN 手电筒



LED

YATO 	
YT-08570	24/192

EN Spotlight
 PL Latarka szperacz
 DE Suchscheinwerfer
 RU Проекторный фонарь
 CZ Ruční svítlna
 HU Keresőlámpa

RO Lanterna
 FR Projecteur de recherche
 IT Faro torcia
 ES Reflector linterna
 CN 多功能探照灯

3.7 V
3000mAh
Li-Ion

380/200
lm

500m

6
LIGHTING MODES
TRISTY SWITCING

6h

4h

x1
HOOK
HAK

USB



**POWER
LED**

YATO	[lm]	
YT-08547	380/200	24

EN Spotlight
 PL Latarka szperacz
 DE Suchscheinwerfer
 RU Проекторный фонарь
 CZ Ruční svítlna
 HU Keresőlámpa

RO Lanterna
 FR Projecteur de recherche
 IT Faro torcia
 ES Reflector linterna
 CN 多功能探照灯

3.7 V
4400mAh
Li-Ion

530
lm

500m

11
LIGHTING MODES
TRISTY SWITCING

5h

3h

4400 mAh

IP54

x1
HOOK
HAK

USB
BATTERY CHARGER
LADOWNARKA



**POWER
LED**

YATO	[lm]	
YT-08579	530/170	10

EN Spotlight
 PL Latarka szperacz
 DE Suchscheinwerfer
 RU Проекторный фонарь
 CZ Ruční svítlna
 HU Keresőlámpa
 RO Lanterna
 FR Projecteur de recherche
 IT Faro torcia
 ES Reflector linterna
 CN 多功能探照灯

16+10
W

3.7 V
8000mAh
Li-Ion

600/1000
lm

244m

9
LIGHTING MODES
TRISTY SWITCING

FLASH
MIGANIE

6h

4.5-25h

8000 mAh

IP54

IK07

USB
CABLE
KABEL

ABS
PC
TPE



**POWER COB
LED**

YATO	[W]	[lm]	
YT-08548	16 (POWER LED - LUXEON V2), 10 (COB LED)	600 (POWER LED), 1000 (COB LED)	10

EN Spotlight
 PL Latarka szperacz
 DE Suchscheinwerfer
 RU Проекторный фонарь
 CZ Ruční svítlna
 HU Keresőlámpa
 RO Lanterna
 FR Projecteur de recherche
 IT Faro torcia
 ES Reflector linterna
 CN 多功能探照灯

10
W

900
lm

200m

FLASH
MIGANIE

IP68

4x
AA



**POWER
LED**

YATO	[W]	[lm]	
YT-08550	10	900/450	10/20

EN Spotlight
 PL Latarka szperacz
 DE Suchscheinwerfer
 RU Проекторный фонарь
 CZ Ruční svítlna
 HU Keresőlámpa
 RO Lanterna
 FR Projecteur de recherche
 IT Faro torcia
 ES Reflector linterna
 CN 多功能探照灯

15
W

3.7 V
4400mAh
Li-Ion

1200
lm

250m

FLASH
MIGANIE

6h

5-6h

4400 mAh

IP68

USB
BATTERY CHARGER
LADOWNARKA



**POWER
LED**

YATO	[W]	[lm]	
YT-08551	15	1200/600	10/20

EN LED headlamp
 PL Latarka czolowa LED
 DE LED Kopflampe
 RU Налобный светодиодный фонарь
 CZ Šelová lampa LED
 HU LED fejlámpa
 RO Lanterna cu LED pt. cap
 FR Lampe frontale LED
 IT Lampada da testa LED
 ES Lámpara LED de cabeza
 CN 头灯

2in1
2w1

3W

3.7 V
700mAh
Li-Po

350
lm

47m

3
LIGHTING MODES
TRISTY SWITCING

FLASH
MIGANIE

2h

1.5-4h

IPX4

IK07

USB

ULTRA LIGHT
ULTRALEKKI

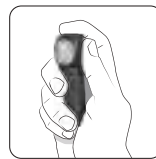

**POWER
LED**

YATO	[lm]	
YT-08597	350 (wysoki), 120 (niski)	10/60

EN LED headlamp
PL Latarka czołowa LED
DE LED Kopflampe
RU Налобный светодиодный фонарь
CZ Čelová lampa LED
HU LED fejlámpa
RO Lanterna cu LED pt. cap
FR Lampe frontale LED
IT Lampada da testa LED
ES Lámpara LED de cabeza
CN 头灯



3W 100lm
ZOOM
3x AAA

POWER
LED

YATO	[W]	[lm]	
YT-08590	3	100	50/100

EN LED headlamp
PL Latarka czołowa LED
DE LED Kopflampe
RU Налобный светодиодный фонарь
CZ Čelová lampa LED
HU LED fejlámpa
RO Lanterna cu LED pt. cap
FR Lampe frontale LED
IT Lampada da testa LED
ES Lámpara LED de cabeza
CN 头灯



10W 450lm
ZOOM
4x AA
LIGHTING MODES TRYBY SWIECENIA

POWER
LED

YATO	[W]	[lm]	
YT-08591	10	450	6/24

EN LED headlamp
PL Latarka czołowa LED
DE LED Kopflampe
RU Налобный светодиодный фонарь
CZ Čelová lampa LED
HU LED fejlámpa
RO Lanterna cu LED pt. cap
FR Lampe frontale LED
IT Lampada da testa LED
ES Lámpara LED de cabeza
CN 头灯



500lm 6 LIGHTING MODES TRYBY SWIECENIA IP44 3x AAA

POWER
LED

YATO	[lm]	
YT-08595	500	12/72

EN LED headlamp
PL Latarka czołowa LED
DE LED Kopflampe
RU Налобный светодиодный фонарь
CZ Čelová lampa LED
HU LED fejlámpa
RO Lanterna cu LED pt. cap
FR Lampe frontale LED
IT Lampada da testa LED
ES Lámpara LED de cabeza
CN 头灯



3.7V 1000mAh Li-Po 500lm 6 LIGHTING MODES TRYBY SWIECENIA 4-5h 4.5-9h IP44

POWER
LED

YATO	[lm]	
YT-08596	500	12/72

EN LED headlamp
PL Latarka czołowa LED
DE LED Kopflampe
RU Налобный светодиодный фонарь
CZ Čelová lampa LED
HU LED fejlámpa
RO Lanterna cu LED pt. cap
FR Lampe frontale LED
IT Lampada da testa LED
ES Lámpara LED de cabeza
CN 头灯



3.7V 1400mAh Li-Po 480lm 2-2.5h 1.5-10h 1m

COB
LED

YATO	[lm]	
YT-08592	480 (300 lm - POWER 100%, 90 lm - POWER 30%, 250 lm - COB 100%, 480 lm - POWER + COB)	6/24

EN LED headlamp
PL Latarka czołowa LED
DE LED Kopflampe
RU Налобный светодиодный фонарь
CZ Čelová lampa LED
HU LED fejlámpa
RO Lanterna cu LED pt. cap
FR Lampe frontale LED
IT Lampada da testa LED
ES Lámpara LED de cabeza
CN 头灯



3.7V 1000mAh Li-Po 3x AAA 500lm 2-2.5h 1h 20min - 10h 1m

COB
LED

YATO	[lm]	
YT-08593	500 (400 lm - POWER 100%, 120 lm - POWER 30%, 200 lm - COB 100%, 500 lm - POWER + COB)	6/24

EN LED headlamp
PL Latarka czołowa LED
DE LED Kopflampe
RU Налобный светодиодный фонарь
CZ Čelová lampa LED
HU LED fejlámpa
RO Lanterna cu LED pt. cap
FR Lampe frontale LED
IT Lampada da testa LED
ES Lámpara LED de cabeza
CN 头灯



3.7V 2200mAh Li-Po 800lm 4h 1.5-5h 1m

COB
LED

YATO	[lm]	
YT-08594	800 (600 lm - POWER 100%, 250 lm - POWER 30%, 250 lm - COB 100%, 800 lm - POWER + COB)	6/24

EN LED headlamp for colour match
PL Lampa czołowa LED do doborzenia kolorów
DE LED-Stirnlampe für Farbenpassung
RU Светодиодный налобный фонарь для подбора цвета
CZ LED čelovka pro barevné sladění
HU LED homloklámpa színválasztáshoz
RO Lanterna cap cu LED pt. potrivirea cunilor
FR Lampe frontale LED adaptation de couleurs
IT Torcia frontale a LED per selezionare colori
ES Lámpara frontal LED para seleccionar colores
CN 头灯-用于对比颜色



CRI 96 3.7V 1500mAh Li-Ion 160lm 2700K 4500K 6500K 3h

3h IP65 IK07 USB CHARGING ŁADOWNIK

YATO	[lm]	
YT-08490	160	40

EN LED headlamp
 PL Latarka czołowa LED
 DE LED Kopflampe
 RU Налобный светодиодный фонарь
 CZ Čelová lampa LED
 HU LED fejlámpa
 RO Lanterna cu LED pt. cap
 FR Lampe frontale LED
 IT Lampada da testa LED
 ES Lámpara LED de cabeza
 CN 头灯

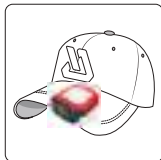

2+1.5 W	3.7 V 500mAh Li-Pol	200/150 lm	21m
4 LIGHTING MODES TRYBY ŚWIĘCENIA	1.5h	2-20h	
IP54	IK07	USB	



SMD LED

YATO	[lm]	
YT-08598	200 (wysoki), 40 (niski), 150 (latarka)	10/100

EN Infrared heater
 PL Promiennik podczerwieni
 DE Infrarotstrahler
 RU Инфракрасный обогреватель
 CZ Infrazářič
 HU Infravörös melegítő
 RO Incalzitör cu infrarosu
 FR Illuminateur infrarouge
 IT Irradiatore a raggi infrarossi
 ES Radiador infrarrojo
 CN 取暖器

220-240V~ 50/60Hz	1500 W	9-12 m²	1 s
5000 h	HALOGEN HALOGENOWY	AI	IP44
		1.9 m	



YATO	[W]	
YT-99500	1500	1

EN Infrared heater
 PL Promiennik podczerwieni
 DE Infrarotstrahler
 RU Инфракрасный обогреватель
 CZ Infrazářič
 HU Infravörös melegítő
 RO Incalzitör cu infrarosu
 FR Illuminateur infrarouge
 IT Irradiatore a raggi infrarossi
 ES Radiador infrarrojo
 CN 取暖器

220-240V~ 50/60Hz	800 W	2-3 m²	2 s
10000 h	CARBON FIBER WŁÓKNY WĘGLOWY	AI	IP44
		1.9 m	



YATO	[W]	
YT-99520	800	4

EN Neck lamp
 PL Latarka na szyję
 DE Halslampe
 RU Фонарь на шею
 CZ Svítilna na krk
 HU Nyaklámpa
 RO Lanterna pt. gat
 FR Lampe torche tour du cou
 IT Torcia da collo
 ES Linterna para el cuello
 CN 脖子灯

3.7 V 2000mAh Li-Ion	150lm x2	4h	3.5-6.5h	1/4" 6.3mm



SMD LED

YATO	[lm]	
YT-08599	150 x2	6/12

EN Infrared heater
 PL Promiennik podczerwieni
 DE Infrarotstrahler
 RU Инфракрасный обогреватель
 CZ Infrazářič
 HU Infravörös melegítő
 RO Incalzitör cu infrarosu
 FR Illuminateur infrarouge
 IT Irradiatore a raggi infrarossi
 ES Radiador infrarrojo
 CN 取暖器

220-240V~ 50/60Hz	1500 W	12-18 m²	1 s
5000 h	HALOGEN HALOGENOWY	AI	IP44
		1.9 m	



YATO	[W]	
YT-99501	1500	1

EN Infrared heater
 PL Promiennik podczerwieni
 DE Infrarotstrahler
 RU Инфракрасный обогреватель
 CZ Infrazářič
 HU Infravörös melegítő
 RO Incalzitör cu infrarosu
 FR Illuminateur infrarouge
 IT Irradiatore a raggi infrarossi
 ES Radiador infrarrojo
 CN 取暖器

220-240V~ 50/60Hz	2000 W	12-18 m²	20 s	TEMPERATURE CONTROL REGULACJA TEMPERATURY
5000 h	QUARTZ KWARCOWY	AI	1.9 m	



Compatible with YT-99570, YT-99571
 Kompatybilny z YT-99570, YT-99571

YATO	[W]	
YT-99530	2000	1

EN Infrared heater
PL Promiennik podczerwieni
DE Infrarotstrahler
RU Инфракрасный обогреватель
CZ Infrazářič
HU Infravörös melegítő
RO Incalzitör cu infrarosu
FR Illuminateur infrarouge
IT Irradiatore a raggi infrarossi
ES Radiador infrarrojo
CN 取暖器



Compatible with YT-99570, YT-99571
Kompatybilny z YT-99570, YT-99571

YATO	[W]	
YT-99531	2000	6

EN Infrared heater
PL Promiennik podczerwieni
DE Infrarotstrahler
RU Инфракрасный обогреватель
CZ Infrazářič
HU Infravörös melegítő
RO Incalzitör cu infrarosu
FR Illuminateur infrarouge
IT Irradiatore a raggi infrarossi
ES Radiador infrarrojo
CN 取暖器



Compatible with YT-99570, YT-99571
Kompatybilny z YT-99570, YT-99571

YATO	[W]	
YT-99532	2000	6

EN Infrared heater
PL Promiennik podczerwieni
DE Infrarotstrahler
RU Инфракрасный обогреватель
CZ Infrazářič
HU Infravörös melegítő
RO Incalzitör cu infrarosu
FR Illuminateur infrarouge
IT Irradiatore a raggi infrarossi
ES Radiador infrarrojo
CN 取暖器



Compatible with YT-99570, YT-99571
Kompatybilny z YT-99570, YT-99571

YATO	[W]	
YT-99536	2000	4

EN Stand for infrared heater
PL Statyw do promienników podczerwieni
DE Infrarotstrahlergestell
RU Подставка для инфракрасных обогревателей
CZ Stojan pro infrazářiče
HU Állvány infravörös melegítőhöz
RO Stand pt. incalzitör cu infrarosu
FR Trépied pour illuminateur infrarouge
IT Treppiede per irradiatore a raggi infrarossi
ES Trípode para radiadores infrarrojos
CN 支架



For YT-99530, YT-99531, YT-99532, YT-99536
Dla YT-99530, YT-99531, YT-99532, YT-99536

YATO	H [mm]	
YT-99570	1100-1800	6

EN Stand for infrared heater
PL Statyw do promienników podczerwieni
DE Infrarotstrahlergestell
RU Подставка для инфракрасных обогревателей
CZ Stojan pro infrazářiče
HU Állvány infravörös melegítőhöz
RO Stand pt. incalzitör cu infrarosu
FR Trépied pour illuminateur infrarouge
IT Treppiede per irradiatore a raggi infrarossi
ES Trípode para radiadores infrarrojos
CN 支架



For YT-99530, YT-99531, YT-99532, YT-99536
Dla YT-99530, YT-99531, YT-99532, YT-99536

YATO	H [mm]	
YT-99571	1100-2100	1

EN Universal travel adapter with USB
PL Uniwersalny adapter podróżny z USB
DE Universal-Reisestecker mit USB
RU Универсальный дорожный адаптер-переходник с USB
CZ Univerzální cestovní adaptér s USB
HU Univerzális utazó adapter USB-vel
RO Adaptor universal de călătorie cu USB
FR Adaptateur de voyage universel avec USB
IT Adattatore universale da viaggio con USB
ES Adaptador universal de viaje con USB
CN 旅行转换插头

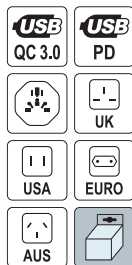

YATO		
YT-81300		50

EN Universal travel adapter with USB
PL Uniwersalny adapter podróżny z USB
DE Universal-Reisestecker mit USB
RU Универсальный дорожный адаптер-переходник с USB
CZ Univerzální cestovní adaptér s USB
HU Univerzális utazó adapter USB-vel
RO Adaptor universal de călătorie cu USB
FR Adaptateur de voyage universel avec USB
IT Adattatore universale da viaggio con USB
ES Adaptador universal de viaje con USB
CN 旅行转换插头

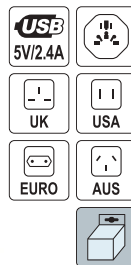

YATO		
YT-81301		50

EN Universal travel adapter
PL Uniwersalny adapter podróżny
DE Universal-Reisestecker
RU Универсальный дорожный адаптер-переходник
CZ Univerzální cestovní adaptér
HU Univerzális utazó adapter
RO Adaptor universal de călătorie
FR Adaptateur de voyage universel
IT Adattatore universale da viaggio
ES Adaptador universal de viaje
CN 旅行转换插头

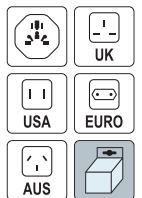

YATO		
YT-81302		50

EN Rubber protection extension cord
 PL Przedłużacz w osłonie gumowej
 DE Gummi Verlängerungskabel
 RU Удлинитель в резиновой изоляции
 CZ Prodlužovací kabel s gumovou izolací
 HU Gumi szigetelésű hosszabbító
 RO Cablu prelungitor cauciuc
 FR Rallonge en caoutchouc
 IT Cavo di prolunga in gomma
 ES Cable de extensión con protección de caucho
 CN 电缆延长线

16A ~250V CABLE HO5RR-F KABEL 3x 1.5 mm² E/F E

IP44



YATO	L [m]	
YT-81025	10	12
YT-81026	20	7
YT-81027	30	6
YT-81028	40	4

EN Rubber protection extension cord
 PL Przedłużacz w osłonie gumowej
 DE Gummi Verlängerungskabel
 RU Удлинитель в резиновой изоляции
 CZ Prodlužovací kabel s gumovou izolací
 HU Gumi szigetelésű hosszabbító
 RO Cablu prelungitor cauciuc
 FR Rallonge en caoutchouc
 IT Cavo di prolunga in gomma
 ES Cable de extensión con protección de caucho
 CN 电缆延长线

16A ~250V CABLE HO7RN-F KABEL 3x 1.5 mm² E/F E

IP44



YATO	L [m]	
YT-81121	5	18
YT-81122	10	12

EN Rubber protection extension cord
 PL Przedłużacz w osłonie gumowej
 DE Gummi Verlängerungskabel
 RU Удлинитель в резиновой изоляции
 CZ Prodlužovací kabel s gumovou izolací
 HU Gumi szigetelésű hosszabbító
 RO Cablu prelungitor cauciuc
 FR Rallonge en caoutchouc
 IT Cavo di prolunga in gomma
 ES Cable de extensión con protección de caucho
 CN 电缆延长线

16A ~250V CABLE HO5RR-F KABEL 3x 2.5 mm² E/F E

IP44 LED LIGHT PROXIA



YATO	L [m]	
YT-81000	10	8
YT-81001	20	5
YT-81002	30	3
YT-81003	40	2

EN Rubber protection extension cord
 PL Przedłużacz w osłonie gumowej
 DE Gummi Verlängerungskabel
 RU Удлинитель в резиновой изоляции
 CZ Prodlužovací kabel s gumovou izolací
 HU Gumi szigetelésű hosszabbító
 RO Cablu prelungitor cauciuc
 FR Rallonge en caoutchouc
 IT Cavo di prolunga in gomma
 ES Cable de extensión con protección de caucho
 CN 电缆延长线

230V~50Hz 16A CABLE HO7RN-F KABEL 3x 1.5 mm² E/F

IP44



YATO	L [m]	
YT-8116	10	4
YT-81162	20	4

EN Extension cord
 PL Przedłużacz budowlany
 DE Bau-Verlängerungskabel
 RU Удлинитель строительный
 CZ Stavební prodlužovací kabel
 HU Építőipari hosszabbító kábel
 RO Prelungitor santier
 FR Rallonge électrique
 IT Prolunga da cantiere
 ES Alargador de obra
 CN 电缆延长线

230V~50Hz 16A CABLE HO5RR-F KABEL 3x 1.5 mm² E/F

IP44



YATO	L [m]	
YT-81030	10	10
YT-81031	15	5
YT-81032	25	4

EN Extension cord
 PL Przedłużacz elektryczny
 DE Verlängerungskabel
 RU Удлинитель электрический
 CZ Elektrický prodlužovač
 HU Elektromos hosszabbító
 RO Prelungitor electric
 FR Rallonge électrique
 IT Prolunga elettrica
 ES Extensión eléctrica
 CN 电源连接器

230V~50Hz 16A CABLE HO7RN-F KABEL 3x 1.5 mm² 3m ON/OFF CHILDREN PROTECTION ZABEZPEČENIE PŘED DĚTMI

E E/F IP44



YATO	L [m]		Socket type / Typ gniazda	
YT-81240	3	3	E	10
YT-81241	3	4	E	10
YT-81242	3	5	E	10

22

Garden tools
Narzędzia ogrodnicze



Watering program
Program wodny

622-627



Hand tools
Narzędzia ręczne

633-635



Hose connectors, male connectors, couplings, hose menders

Złącza, nypie, łączniki, rozgałęziacze, reparatory..... 622

Hose nozzles (sprinklers) & sets

Zraszacze i zestawy..... 624

Garden hose holders

Stojaki na węże ogrodowe..... 627

Small garden tools

Małe narzędzia ogrodowe..... 633

Big garden tools

Duże narzędzia ogrodowe..... 634

Accessories

Akcesoria..... 635

Pruners & shears

Sekatory i nożyce ogrodowe

627-632



Pruners

Sekatory..... 627

Lopping shears

Sekatory do gałęzi..... 630

Leverage tree pruners

Sekatory gąsienicowe..... 631

Hedge shears

Nożyce do żywopłotu..... 632

Grass shears

Nożyce do trawy..... 632

EN Hose connector
 PL Złącze standard
 DE Universal Schnellschlauchkupplung
 RU Соединитель
 CZ Rychlospojka
 HU Fitting
 RO Mufă pt. pistol
 FR Raccord standard
 IT Connettore standard
 ES Junta estandard
 CN 通水接头



Ø 1/2"
 12.7mm
 ABS
 PP
 TPR

YATO  
 YT-99801 12/120

EN Waterstop hose connector
 PL Złącze stop
 DE Universal Schnellschlauchkupplung mit Wasserstop
 RU Соединитель с автостопом
 CZ Rychlospojka
 HU Fitting
 RO Mufă pt. pistol
 FR Raccord stop
 IT Connettore stop
 ES Junta estandard
 CN 止水接头



Ø 1/2"
 12.7mm
 STOP
 ABS
 PP
 TPR

YATO  
 YT-99803 12/120

EN Hose connector
 PL Złącze standard
 DE Universal Schnellschlauchkupplung
 RU Соединитель
 CZ Rychlospojka
 HU Fitting
 RO Mufă pt. pistol
 FR Raccord standard
 IT Connettore standard
 ES Junta estandard
 CN 通水接头





Ø 3/4"
 19mm
 ABS
 PP
 TPR

YATO  
 YT-99802 12/120

EN Waterstop hose connector
 PL Złącze stop
 DE Universal Schnellschlauchkupplung mit Wasserstop
 RU Соединитель с автостопом
 CZ Rychlospojka
 HU Fitting
 RO Mufă pt. pistol
 FR Raccord stop
 IT Connettore stop
 ES Junta estandard
 CN 止水接头





Ø 3/4"
 19mm
 STOP
 ABS
 PP
 TPR

YATO  
 YT-99804 12/120

EN Hose mender
 PL Reparatör do węzła
 DE Schlauchreparatur
 RU Мифта ремонтная для шланга
 CZ Hadicová spojka
 HU Tömítőlődő
 RO Mufă înădire
 FR Réparateur de tuyau
 IT Riparatore giuntatubi
 ES Reparatör para manguera
 CN 修补接头





Ø 1/2"
 12.7mm
 ABS
 PP
 TPR

YATO  
 YT-99810 12/120

EN Hose mender
 PL Reparatör do węzła
 DE Schlauchreparatur
 RU Мифта ремонтная для шланга
 CZ Hadicová spojka
 HU Tömítőlődő
 RO Mufă înădire
 FR Réparateur de tuyau
 IT Riparatore giuntatubi
 ES Reparatör para manguera
 CN 修补接头





Ø 3/4"
 19mm
 ABS
 PP
 TPR

YATO  
 YT-99811 12/120

EN Hose reducer
 PL Reparatör redukcyjny do węzła
 DE Reparaturstück mit Reduzierung
 RU Редуктор для шланга
 CZ Hadicová redukční spojka
 HU Tömítő összekötő
 RO Reducție
 FR Réducteur de tuyau
 IT Giunto di riduzione per tubi
 ES Reductor de manguera
 CN 修补接头





Ø 1/2"
 12.7mm
 Ø 3/4"
 19mm
 ABS

YATO  
 YT-8979 24/240

EN Tap adaptor
 PL Przyłącze do kranu
 DE Wasserhahnanschluss
 RU Адаптер для крана
 CZ Kohoutkový adaptér
 HU Csapcsatlakozó
 RO Mufă pt. robinet
 FR Raccord à robinet
 IT Connettore per rubinetto
 ES Conexión de grifo
 CN 水龙头转换接头





ABS 

YATO  
 YT-8970 24/240

EN Tap adaptor
 PL Przyłącze do kranu
 DE Wasserhahnanschluss
 RU Адаптер для крана
 CZ Kohoutkový adaptér
 HU Csapcsatlakozó
 RO Mufă pt. robinet
 FR Raccord à robinet
 IT Connettore per rubinetto
 ES Conexión de grifo
 CN 水龙头转换接头



(F)
 G3/4
 ABS 

YATO  
 YT-8971 12/120

EN Tap adaptor
 PL Przyłącze do kranu
 DE Wasserhahnanschluss
 RU Адаптер для крана
 CZ Kohoutkový adaptér
 HU Csapcsatlakozó
 RO Mufă pt. robinet
 FR Raccord à robinet
 IT Connettore per rubinetto
 ES Conexión de grifo
 CN 水龙头转换接头



(F)
 G3/4
 ABS
 TPR 

YATO  
 YT-99812 12/120

EN Tap adaptor
 PL Przyłącze do kranu
 DE Wasserhahnanschluss
 RU Адаптер для крана
 CZ Kohoutkový adaptér
 HU Csapcsatlakozó
 RO Mufă pt. robinet
 FR Raccord à robinet
 IT Connettore per rubinetto
 ES Conexión de grifo
 CN 水龙头转换接头



(F)
 G1
 ABS 

YATO  
 YT-8972 12/120

EN Tap adaptor
 PL Przyłącze do kranu
 DE Wasserhahnanschluss
 RU Адаптер для крана
 CZ Kohoutkový adaptér
 HU Csapcsatlakozó
 RO Mufă pt. robinet
 FR Raccord à robinet
 IT Connettore per rubinetto
 ES Conexión de grifo
 CN 水龙头转换接头



(F)
 G1
 ABS
 TPR 

YATO  
 YT-99813 12/120

EN Tap adaptor
PL Przyłącze do kranu
DE Wasserhahnanschluss
RU Адаптер для крана
CZ Kohoutkový adaptér
HU Csapcsatlakozó
RO Mufă pt. robinet
FR Raccord à robinet
IT Connettore per rubinetto
ES Conexión de grifo
CN 水龙头转换接头



(F)
G1/2
(F)
G3/4
ABS

EN Tap adaptor
PL Przyłącze do kranu
DE Wasserhahnanschluss
RU Адаптер для крана
CZ Kohoutkový adaptér
HU Csapcsatlakozó
RO Mufă pt. robinet
FR Raccord à robinet
IT Connettore per rubinetto
ES Conexión de grifo
CN 水龙头转换接头



(F)
G1/2
(F)
G3/4
ABS
TPR

EN Tap adaptor
PL Przyłącze do kranu
DE Wasserhahnanschluss
RU Адаптер для крана
CZ Kohoutkový adaptér
HU Csapcsatlakozó
RO Mufă pt. robinet
FR Raccord à robinet
IT Connettore per rubinetto
ES Conexión de grifo
CN 水龙头转换接头



(F)
G3/4
(F)
G1
ABS

YATO 
YT-8973

 12/120

YATO 
YT-99814

 12/120

YATO 
YT-8974

 12/120

EN Tap adaptor
PL Przyłącze do kranu
DE Wasserhahnanschluss
RU Адаптер для крана
CZ Kohoutkový adaptér
HU Csapcsatlakozó
RO Mufă pt. robinet
FR Raccord à robinet
IT Connettore per rubinetto
ES Conexión de grifo
CN 水龙头转换接头



(F)
G3/4
(F)
G1
ABS
TPR

EN Tap adaptor
PL Przyłącze do kranu
DE Wasserhahnanschluss
RU Адаптер для крана
CZ Kohoutkový adaptér
HU Csapcsatlakozó
RO Mufă pt. robinet
FR Raccord à robinet
IT Connettore per rubinetto
ES Conexión de grifo
CN 水龙头转换接头



(M)
G3/4
ABS

EN Hose coupling
PL Łącznik
DE Schlauchkupplung
RU Соединитель
CZ Spojka
HU Tömölcsatlakozás
RO Racord
FR Raccord
IT Raccordo
ES Acoplador
CN 接头



ABS

YATO 
YT-99815

 12/120

YATO 
YT-8975

 24/240

YATO 
YT-8976

 24/240

EN Hose coupling
PL Rozdzielacz
DE Wasserverteiler
RU Тройник-соединитель
CZ Rozdělovač
HU Vízelosztó
RO Racord 3 căi
FR Séparateur de tuyau
IT Distributore
ES Divisor de manguera
CN 三通接头



ABS 

EN Y-switch coupling with swivel
PL Rozdzielacz z zaworami
DE 2-Wege Ventil
RU Распределитель внешний
CZ Rozbočovač s uzavíracími ventily
HU Y-elágazó, 2 db külső menetes elzáróval
RO Racord iny cu robinet
FR Dérivation type „Y”
IT Distributore con valvole
ES Distribuidor tipo „Y”
CN 双通水管转换接头



(M) (F)
G3/4 **G3/4**
ABS 

EN One way tap adaptor
PL Zawór ogrodowy
DE Garten-Ventil
RU Вентиль
CZ Ventil
HU Szelep
RO Robinet
FR Raccord régulateur
IT Valvola giardino
ES Válvula
CN 接头



(F)
G3/4
BRASS
MOSIADZ
AI
ABS

YATO 
YT-8977

 24/240

YATO 
YT-8978

 24/240

YATO 
YT-9940

 12/48

EN Y-switch coupling with swivel
PL Rozdzielacz z zaworami
DE 2-Wege Ventil
RU Распределитель внешний
CZ Rozbočovač s uzavíracími ventily
HU Y-elágazó, 2 db külső menetes elzáróval
RO Racord iny cu robinet
FR Soupape double
IT Distributore con valvole
ES Distribuidor tipo „Y”
CN 两用转换接头



(F) (F)
G3/4 **G1**
ABS 

EN Y-switch coupling with swivel
PL Rozdzielacz z zaworami
DE 2-Wege Ventil
RU Распределитель внешний
CZ Rozbočovač s uzavíracími ventily
HU Y-elágazó, 2 db külső menetes elzáróval
RO Racord iny cu robinet
FR Soupape double
IT Distributore con valvole
ES Distribuidor tipo „Y”
CN 两用转换接头



(F) **BRASS**
G3/4 **MOSIADZ**
AI **ABS**

YATO 
YT-99848

 12/48

YATO 
YT-9941

 12/48

EN Adjustable spray nozzle
 PL Zrasczacz prosty regulowany
 DE Spritze
 RU Распылитель поливочный
 CZ Postríkovač
 HU Szórófej

RO Stropitor apă
 FR Pistolet d'arrosage droit et réglé
 IT Semplice sprinkler regolabile
 ES Rociador
 CN 调节式水枪



ABS
PP
TPR



YATO 

YT-99830

12/120

EN Adjustable spray gun
 PL Pistolet zraszający regulowany
 DE Regelbare Sprühpistole
 RU Регулируемый оросительный пистолет
 CZ Kropící pistole regulovatelná
 HU Öntöző pisztoly állítható sugarú
 RO Pistolet de irigare ajustabil
 FR Pistolet d'arrosage réglé
 IT Pistola a spruzzo regolabile
 ES Pistola rociadora ajustable
 CN 调节式水枪



ABS



AI



ABS



YATO 

YT-8955

12/48

EN Adjustable spray gun
 PL Pistolet zraszający regulowany
 DE Regelbare Sprühpistole
 RU Регулируемый оросительный пистолет
 CZ Kropící pistole regulovatelná
 HU Öntöző pisztoly állítható sugarú
 RO Pistolet de irigare ajustabil
 FR Pistolet d'arrosage réglé
 IT Pistola a spruzzo regolabile
 ES Pistola rociadora ajustable
 CN 调节式水枪



ABS



AI



ABS



YATO 

YT-8956

12/48

EN Adjustable spray gun
 PL Pistolet zraszający regulowany
 DE Regelbare Sprühpistole
 RU Регулируемый оросительный пистолет
 CZ Kropící pistole regulovatelná
 HU Öntöző pisztoly állítható sugarú
 RO Pistolet de irigare ajustabil
 FR Pistolet d'arrosage réglé
 IT Pistola a spruzzo regolabile
 ES Pistola rociadora ajustable
 CN 调节式水枪



ABS



BRASS
MOSIADZ



YATO 

YT-8967

12

EN Adjustable spray gun
 PL Pistolet zraszający regulowany
 DE Regelbare Sprühpistole
 RU Регулируемый оросительный пистолет
 HU Öntöző pisztoly állítható sugarú
 RO Pistolet de irigare ajustabil
 FR Pistolet d'arrosage réglé
 IT Pistola a spruzzo regolabile
 ES Pistola rociadora ajustable
 CN 调节式水枪



ABS



AI



ABS



YATO 

YT-8965

12/48

EN Adjustable spray gun
 PL Pistolet zraszający regulowany
 DE Regelbare Sprühpistole
 RU Регулируемый оросительный пистолет
 CZ Kropící pistole regulovatelná
 HU Öntöző pisztoly állítható sugarú
 RO Pistolet de irigare ajustabil
 FR Pistolet d'arrosage réglé
 IT Pistola a spruzzo regolabile
 ES Pistola rociadora ajustable
 CN 调节式水枪



ABS



AI



ABS



YATO 

YT-8966

12/48

EN Adjustable spray gun
 PL Pistolet zraszający regulowany
 DE Regelbare Sprühpistole
 RU Регулируемый оросительный пистолет
 CZ Kropící pistole regulovatelná
 HU Öntöző pisztoly állítható sugarú
 RO Pistolet de irigare ajustabil
 FR Pistolet d'arrosage réglé
 IT Pistola a spruzzo regolabile
 ES Pistola rociadora ajustable
 CN 铝合金调节式水枪



ABS



AI



ABS



YATO 

YT-8957

12/48

EN Multifunction sprinkling gun
 PL Wielofunkcyjny pistolet zraszający
 DE Multifunktions-Spritzpistole
 RU Многофункциональный оросительный пистолет
 CZ Multifunkční postřikovací pistole
 HU Többfunkciós öntöző pisztoly
 RO Pistol multifuncțional pt. pulverizare
 FR Pistolet d'arrosage multifonctions
 IT Multifunzione pistola a spruzzo
 ES Pistola para regar multifuncional
 CN 六用途调节式水枪



ABS



AI



ABS



YATO 

YT-8958

12/48

EN Multifunction sprinkling gun
PL Wielofunkcyjny pistolet zraszający
DE Multifunktions-Spritzpistole
RU Многофункциональный оросительный пистолет
CZ Multifunkční postřikovací pistole
HU Többfunkciós öntöző pisztoly
RO Pistol multifuncțional pt. pulverizare
FR Pistolet d'arrosage multifonctions
IT Multifunzione pistola a spruzzo
ES Pistola para regar multifuncional
CN 六用途调节式水枪

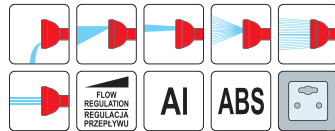

YATO
YT-8964

 12/48

EN Multifunction sprinkling gun
PL Wielofunkcyjny pistolet zraszający
DE Multifunktions-Spritzpistole
RU Многофункциональный оросительный пистолет
CZ Multifunkční postřikovací pistole
HU Többfunkciós öntöző pisztoly
RO Pistol multifuncțional pt. pulverizare
FR Pistolet d'arrosage multifonctions
IT Multifunzione pistola a spruzzo
ES Pistola para regar multifuncional
CN 六用途调节式水枪

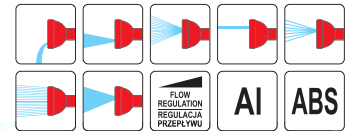

YATO
YT-8963

 12/48

EN Multifunction sprinkling gun
PL Wielofunkcyjny pistolet zraszający
DE Multifunktions-Spritzpistole
RU Многофункциональный оросительный пистолет
CZ Multifunkční postřikovací pistole
HU Többfunkciós öntöző pisztoly
RO Pistol multifuncțional pt. pulverizare
FR Pistolet d'arrosage multifonctions
IT Multifunzione pistola a spruzzo
ES Pistola para regar multifuncional
CN 六用途调节式水枪

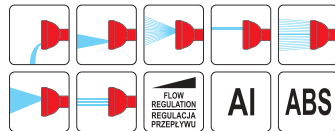

YATO
YT-8959

 12/48

EN Multifunction sprinkling gun
PL Wielofunkcyjny pistolet zraszający
DE Multifunktions-Spritzpistole
RU Многофункциональный оросительный пистолет
CZ Multifunkční postřikovací pistole
HU Többfunkciós öntöző pisztoly
RO Pistol multifuncțional pt. pulverizare
FR Pistolet d'arrosage multifonctions
IT Multifunzione pistola a spruzzo
ES Pistola para regar multifuncional
CN 六用途调节式水枪

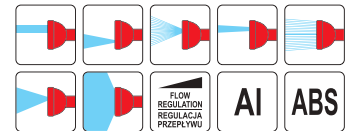

YATO
YT-8960

 12/48

EN Multifunction sprinkling gun
PL Wielofunkcyjny pistolet zraszający
DE Multifunktions-Spritzpistole
RU Многофункциональный оросительный пистолет
CZ Multifunkční postřikovací pistole
HU Többfunkciós öntöző pisztoly
RO Pistol multifuncțional pt. pulverizare
FR Pistolet d'arrosage multifonctions
IT Multifunzione pistola a spruzzo
ES Pistola para regar multifuncional
CN 六用途调节式水枪

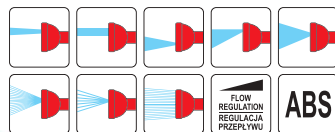

YATO
YT-9984

 12/48

EN Multifunction sprinkling gun
PL Wielofunkcyjny pistolet zraszający
DE Multifunktions-Spritzpistole
RU Многофункциональный оросительный пистолет
CZ Multifunkční postřikovací pistole
HU Többfunkciós öntöző pisztoly
RO Pistol multifuncțional pt. pulverizare
FR Pistolet d'arrosage multifonctions
IT Multifunzione pistola a spruzzo
ES Pistola para regar multifuncional
CN 六用途调节式水枪

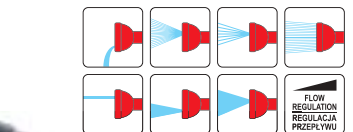

YATO
YT-8968

 12

EN Basic hose set with straight nozzle
 PL Zestaw złączek ze zraszaczem prostym
 DE Bewässerungs Spritz und Anschlusset
 RU Набор поливочный
 CZ Sada postřikovač a spojky
 HU Készlet gyorskapoccsal csaphoz
 RO Ștut furtun apă cu accesorii pt. robinet
 FR Set d'arrosage raccord
 IT Set raccordi con sprinkler semplice
 ES Juego de rociar tubuladura de grifo
 CN 花园浇水软管



YATO
YT-99831

48

EN Basic hose set with straight nozzle
 PL Zestaw złączek ze zraszaczem prostym
 DE Bewässerungs Spritz und Anschlusset
 RU Набор поливочный
 CZ Sada postřikovač a spojky
 HU Készlet gyorskapoccsal csaphoz
 RO Ștut furtun apă cu accesorii pt. robinet
 FR Set d'arrosage raccord
 IT Set raccordi con sprinkler semplice
 ES Juego de rociar tubuladura de grifo
 CN 花园浇水软管



YATO
YT-99832

48

EN Impulse sprinkler
 PL Zraszacz impulsowy
 DE Impulssprenger
 RU Распылитель импульсный на пике
 CZ Postřikovač
 HU Impulzus szórófej
 RO Stropitor apă
 FR Arroseur impulsion sur piquet
 IT Sprinkler impulso
 ES Rociador
 CN 脉冲洒水器



YATO
YT-8985

48

EN Impulse sprinkler
 PL Zraszacz impulsowy
 DE Impulssprenger
 RU Распылитель импульсный на пике
 CZ Postřikovač
 HU Impulzus szórófej
 RO Stropitor apă
 FR Arroseur impulsion sur piquet
 IT Sprinkler impulso
 ES Rociador
 CN 脉冲洒水器



YATO
YT-8986

48

EN 3-arms revolving sprinkler
 PL Zraszacz 3-ramienny
 DE 3-Arm Kreis-Regner
 RU Трёхсторонний распылитель
 CZ Rozprašováč třiramenný
 HU Forgó locsoló leszűrhető
 RO Aspersol cu 3 brate
 FR Arroseur sur piquet 3 branches
 IT Tre braccio sprinkler
 ES Rociador 3-brazos
 CN 三叉插针洒水器



YATO
YT-8987

48

EN Tripod impulse sprinkler
 PL Zraszacz impulsowy na statywie
 DE Impulssprenger
 RU Распылитель импульсный
 CZ Postřikovač
 HU Impulzus szórófej
 RO Stropitor apă
 FR Arroseur impulsion lance
 IT Sprinkler impulso su un treppiede
 ES Rociador
 CN 洒水器



YATO
YT-8984

12

EN 8 pattern sprinkler
 PL Zraszacz 8-funkcyjny
 DE 8-Flächenregner
 RU Распылитель 8-позиционный на подставке
 CZ Postřikovač
 HU 8 funkciós szórófej
 RO Stropitor apă cu 8 duze
 FR Turbine d'arrosage 8 fonctionnes
 IT Sprinkler 8-funzioni
 ES Rociador 8-funciones de tierra
 CN 洒水器

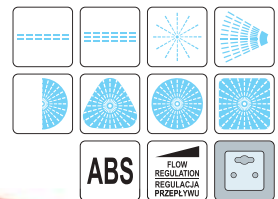

YATO
YT-8991

48

EN Aluminium tube oscillating sprinkler
PL Zraszacz oscylacyjny z rurką aluminiową
DE Rechteckregner
RU Распылитель осциллирующий
CZ Obdélníkový zavlažovač
HU Oszcillációs szórófeje

RO Aspersor oscilant
FR Arroseur oscillant aluminium
IT Oscillante sprinkler con tubo di alluminio
ES Aspersor oscilante con tubo de aluminio
CN 摇摆洒水器



YATO YT-8993 6

EN Aluminium tube oscillating sprinkler
PL Zraszacz oscylacyjny z rurką aluminiową
DE Rechteckregner
RU Распылитель осциллирующий
CZ Obdélníkový zavlažovač
HU Oszcillációs szórófeje

RO Aspersor oscilant
FR Arroseur oscillant aluminium
IT Oscillante sprinkler con tubo di alluminio
ES Aspersor oscilante con tubo de aluminio
CN 摇摆洒水器



YATO YT-99845 6

EN Hose holder
PL Stojak do węża ogrodowego
DE Gartenschlauchträger
RU Барабан для намотки поливочного шланга
CZ Stojan navjlecí na zahradní hadici
HU Utartódob locsolótömlőhöz
RO Suport pt. furtun
FR Dévidoir portable de tuyau
IT Carrello avvolgitubo
ES Estante para manguera de jardín
CN 卷线盘

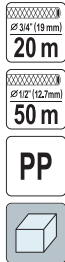

YATO YT-99850 2

EN Hose cart
PL Wózek do węża ogrodowego
DE Gartenschlauchwagen
RU Барабан для намотки поливочного шланга
CZ Stojan navjlecí na zahradní hadici
HU Utartódob locsolótömlőhöz
RO Suport pt. furtun
FR Dévidoir sur roues
IT Carrello avvolgitubo
ES Carretila para manguera de jardín
CN 卷线盘



YATO YT-99852 2

EN Bypass pruner
PL Sekator uniwersalny
DE Gartenschere
RU Секатор
CZ Zahradní nůžky
HU Metszőolló

RO Foarfece pt. pomi
FR Sécateur traditionnel
IT Forbici da potatura universale
ES Tijera de poda
CN 剪枝剪



YATO L [mm] YT-8800 205 12/72

EN Bypass pruner
PL Sekator uniwersalny
DE Gartenschere
RU Секатор
CZ Zahradní nůžky
HU Metszőolló

RO Foarfece pt. pomi
FR Sécateur traditionnel
IT Forbici da potatura universale
ES Tijera de poda
CN 剪枝剪



YATO L [mm] YT-8801 220 12/72

EN Anvil pruner
PL Sekator kowadłkowy
DE Amboss-Gartenschere
RU Секатор с наковальней
CZ Kovadlinkové zahradní nůžky
HU Metszőolló

RO Foarfece nicovala
FR Sécateur à enclume
IT Forbici a incudine
ES Tijera de poda de yunque
CN 剪枝剪



YATO L [mm] YT-8802 200 12/72

EN Bypass pruner
PL Sekator uniwersalny
DE Gartenschere
RU Секатор
CZ Zahradní nůžky
HU Metszőolló

RO Foarfece pt. pomi
FR Sécateur traditionnel
IT Forbici da potatura universale
ES Tijera de poda
CN 剪枝剪



YATO L [mm] YT-8805 180 12/72

EN Ratchet by-pass pruner
PL Sekator z grzechotką
DE Gartenschere
RU Секатор
CZ Nožnice zahradnicke
HU Metszőolló

RO Foarfece pt. pomi
FR Sécateur à cliquet
IT Cesioia con cricchetto
ES Podadera con carraca
CN 棘轮剪枝剪

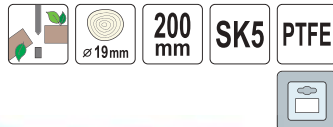

YATO  L [mm] 
YT-8807 200 12/72

EN Ratchet by-pass pruner
PL Sekator z grzechotką
DE Gartenschere
RU Секатор
CZ Nožnice zahradnicke
HU Metszőolló

RO Foarfece pt. pomi
FR Sécateur à cliquet
IT Cesioia con cricchetto
ES Podadera con carraca
CN 棘轮剪枝剪



YATO  L [mm] 
YT-8808 200 12/72

EN Anvil pruner
PL Sekator kowadełkowy
DE Amboss-Gartenschere
RU Секатор с наковальней
CZ Kovadlinkové zahradní nůžky
HU Metszőolló

RO Foarfece nicovala
FR Sécateur à enclume
IT Forbici a incudine
ES Tijera de poda de yunque
CN 剪枝剪



YATO  L [mm] 
YT-8809 210 12/72

EN Bypass pruner
PL Sekator uniwersalny
DE Gartenschere
RU Секатор
CZ Zahradní nůžky
HU Metszőolló

RO Foarfece pt. pomi
FR Sécateur traditionnel
IT Forbici da potatura universale
ES Tijera de poda
CN 剪枝剪



YATO  L [mm] 
YT-8811 190 12/72

EN Bypass pruner
PL Sekator uniwersalny
DE Gartenschere
RU Секатор
CZ Zahradní nůžky
HU Metszőolló

RO Foarfece pt. pomi
FR Sécateur traditionnel
IT Forbici da potatura universale
ES Tijera de poda
CN 剪枝剪



YATO  L [mm] 
YT-8845 200 12/72

EN Bypass pruner
PL Sekator uniwersalny
DE Gartenschere
RU Секатор
CZ Zahradní nůžky
HU Metszőolló

RO Foarfece pt. pomi
FR Sécateur traditionnel
IT Forbici da potatura universale
ES Tijera de poda
CN 剪枝剪



YATO  L [mm] 
YT-8790 200 12/60

EN Fruit and flower shears
PL Sekator do obcinania zawiązków
DE Blumen- und Rebschere
RU Секатор
CZ Nožnice zahradnicke
HU Metszőolló

RO Foarfece pt. pomi
FR Sécateur
IT Cesioia taglio gemme
ES Podadera para cortar germenos
CN 剪枝剪



YATO  L [mm] 
YT-8791 200 12/60

EN Fruit and flower shears
PL Sekator do obcinania zawiązków
DE Blumen- und Rebschere
RU Секатор
CZ Nožnice zahradnicke
HU Metszőolló

RO Foarfece pt. pomi
FR Sécateur
IT Cesioia taglio gemme
ES Podadera para cortar germenos
CN 花枝剪

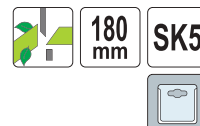

YATO  L [mm] 
YT-8815 180 12/72

EN Fruit and flower shears
PL Sekator do obcinania zawiązków
DE Blumen- und Rebschere
RU Секатор
CZ Nožnice zahradnicke
HU Metszőolló

RO Foarfece pt. pomi
FR Sécateur
IT Cesioia taglio gemme
ES Podadera para cortar germenos
CN 花枝剪



YATO  L [mm] 
YT-8816 190 12/72

EN Fruit and flower shears
PL Sekator do obcinania zawiązków
DE Blumen- und Rebschere
RU Секатор
CZ Nožnice zahradnicke
HU Metszőolló

RO Foarfece pt. pomi
FR Sécateur
IT Cesioia taglio gemme
ES Podadera para cortar germenos
CN 花枝剪



YATO  L [mm] 
YT-8817 190 12/72

EN Grafting tool
PL Sekator do szczepień
DE Gartenschere zum Pfropfen
RU Секатор для прививки
CZ Roubovací nůžky
HU Oltó olló
RO Instrument pt. altoit
FR Sécateur de greffage
IT Forbici da innesto
ES Tijera injertadora
CN 嫁接剪



YATO
YT-88505



20

EN Bypass pruner
PL Sekator uniwersalny
DE Gartenschere
RU Секатор
CZ Zahradní nůžky
HU Metszőolló
RO Foarfece pt. pomi
FR Sécateur traditionnel
IT Forbici da potatura universale
ES Tijera de poda
CN 剪枝剪



YATO
YT-88180

L [mm]

208



12/48

EN Anvil pruner
PL Sekator kowadełkowy
DE Amboss-Gartenschere
RU Секатор с наковальной
CZ Kovadlinkové zahradní nůžky
HU Metszőolló
RO Foarfece nicovala
FR Sécateur à enclume
IT Forbici a incudine
ES Tijera de poda de yunque
CN 修枝剪



YATO
YT-88182

L [mm]

208



12/48

EN Bypass pruner
PL Sekator uniwersalny
DE Gartenschere
RU Секатор
CZ Zahradní nůžky
HU Metszőolló
RO Foarfece pt. pomi
FR Sécateur traditionnel
IT Forbici da potatura universale
ES Tijera de poda
CN 剪枝剪



YATO
YT-88183

L [mm]

205



12/48

EN Bypass pruner
PL Sekator uniwersalny
DE Gartenschere
RU Секатор
CZ Zahradní nůžky
HU Metszőolló
RO Foarfece pt. pomi
FR Sécateur traditionnel
IT Forbici da potatura universale
ES Tijera de poda
CN 剪枝剪



YATO
YT-88185

L [mm]

220



12/48

EN Bypass pruner
PL Sekator uniwersalny
DE Gartenschere
RU Секатор
CZ Zahradní nůžky
HU Metszőolló
RO Foarfece pt. pomi
FR Sécateur traditionnel
IT Forbici da potatura universale
ES Tijera de poda
CN 剪枝剪



YATO
YT-88186

L [mm]

220



12/48

EN Bypass pruner
PL Sekator uniwersalny
DE Gartenschere
RU Секатор
CZ Zahradní nůžky
HU Metszőolló
RO Foarfece pt. pomi
FR Sécateur traditionnel
IT Forbici da potatura universale
ES Tijera de poda
CN 剪枝剪



YATO
YT-88190

L [mm]

208



12/48

EN Anvil pruner
PL Sekator kowadełkowy
DE Amboss-Gartenschere
RU Секатор с наковальной
CZ Kovadlinkové zahradní nůžky
HU Metszőolló
RO Foarfece nicovala
FR Sécateur à enclume
IT Forbici a incudine
ES Tijera de poda de yunque
CN 修枝剪



YATO
YT-88191

L [mm]

208





12/48

EN Bypass pruner
 PL Sekator uniwersalny
 DE Gartenschere
 RU Секатор
 CZ Zahradní nůžky
 HU Metszőolló

RO Foarfece pt. pomi
 FR Sécateur traditionnel
 IT Forbici da potatura universale
 ES Tijera de poda
 CN 剪枝剪



  **180 mm**

SS
STAINLESS STEEL
ETAL MEGECERVA

AI
HANDLE
UCHWYT

LOCK
BLOKADA



YATO 	L [mm]	
YT-8843	180	5/60

EN Bypass pruner
 PL Sekator uniwersalny
 DE Gartenschere
 RU Секатор
 CZ Zahradní nůžky
 HU Metszőolló

RO Foarfece pt. pomi
 FR Sécateur traditionnel
 IT Forbici da potatura universale
 ES Tijera de poda
 CN 剪枝剪

  **200 mm**

SK5

AI
HANDLE
UCHWYT



YATO 	L [mm]	
YT-8849	200	12/72

EN Anvil lopper
 PL Sekator kowadełkowy do gałęzi
 DE Amboss-Astscherer
 RU Сучкорез с наковальной
 CZ Nůžky na větve
 HU Karos ágváágó olló

RO Foarfece curbata pt. taiat crengi
 FR Coupe-branches à éclume
 IT Cesovia tagliarami a incudine
 ES Tijera de poda de yunque
 CN 高枝剪

  **25 mm**



635 mm



YATO 	L [mm]	
YT-8832	635	12

EN Anvil lopper
 PL Sekator kowadełkowy do gałęzi
 DE Amboss-Astscherer
 RU Сучкорез с наковальной
 CZ Nůžky na větve
 HU Karos ágváágó olló

RO Foarfece curbata pt. taiat crengi
 FR Coupe-branches à éclume
 IT Cesovia tagliarami a incudine
 ES Tijera de poda de yunque
 CN 高枝剪

  **35 mm**

700 mm



PTFE



YATO 	L [mm]	
YT-8834	700	12

EN Bypass lopper
 PL Sekator do gałęzi
 DE Astschere
 RU Сучкорез
 CZ Nůžky na větve
 HU Ágvágó olló

RO Foarfece curbata pt. taiat crengi
 FR Coupe-branches
 IT Cesovia tagliarami
 ES Tijera para ramas
 CN 高枝剪

  **35 mm**

780 mm

PTFE



YATO 	L [mm]	
YT-8835	780	12

EN Anvil lopper
PL Sekator kowadełkowy do gałęzi
DE Amboss-Astscherer
RU Сучкорез с наковальной
CZ Nůžky na větve
HU Karos ágváágó ollók

RO Foarfeca curbata pt. taiat crengi
FR Coupe-branches à éclume
IT Cesovia tagliarami a incudine
ES Tijera de poda de yunque
CN 高枝剪





YATO 	L [mm]	
YT-8836	770	12

EN Telescopic bypass lopper
PL Sekator teleskopowy do gałęzi
DE Teleskop-Astscherer
RU Сучкорез телескопический
CZ Teleskopické nůžky na větve
HU Ágvágó teleszkópos

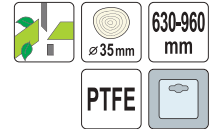
RO Foarfeca telescopica pt. crengi
FR Coupe-branches télescopique
IT Cesovia tagliarami telescopici
ES Tijera de poda telescópica
CN 可伸缩高枝剪





YATO 	L [mm]	
YT-8838	630-960	6/12

EN Telescopic bypass lopper
PL Sekator teleskopowy do gałęzi
DE Teleskop-Astscherer
RU Сучкорез телескопический
CZ Teleskopické nůžky na větve
HU Ágvágó teleszkópos

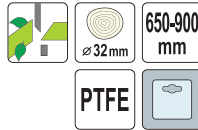
RO Foarfeca telescopica pt. crengi
FR Coupe-branches télescopique
IT Cesovia tagliarami telescopici
ES Tijera de poda telescópica
CN 可伸缩高枝剪





YATO 	L [mm]	
YT-8839	650-900	6

EN Telescopic bypass lopper
PL Sekator teleskopowy do gałęzi
DE Teleskop-Astscherer
RU Сучкорез телескопический
CZ Teleskopické nůžky na větve
HU Ágvágó teleszkópos

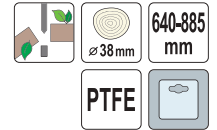
RO Foarfeca telescopica pt. crengi
FR Coupe-branches télescopique
IT Cesovia tagliarami telescopici
ES Tijera de poda telescópica
CN 可伸缩高枝剪



YATO 	L [mm]	
YT-8840	640-885	12

EN Telescopic bypass lopper
PL Sekator teleskopowy do gałęzi
DE Teleskop-Astscherer
RU Сучкорез телескопический
CZ Teleskopické nůžky na větve
HU Ágvágó teleszkópos

RO Foarfeca telescopica pt. crengi
FR Coupe-branches télescopique
IT Cesovia tagliarami telescopici
ES Tijera de poda telescópica
CN 可伸缩高枝剪





YATO 	L [mm]	
YT-8841	690-930	6

EN Telescopic bypass lopper
PL Sekator teleskopowy do gałęzi
DE Teleskop-Astscherer
RU Сучкорез телескопический
CZ Teleskopické nůžky na větve
HU Ágvágó teleszkópos



RO Foarfeca telescopica pt. crengi
FR Coupe-branches télescopique
IT Cesovia tagliarami telescopici
ES Tijera de poda telescópica
CN 可伸缩高枝剪

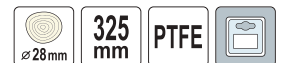

YATO 	L [mm]	
YT-8842	660-910	12

EN Leverage tree pruner
PL Sekator gasienicowy z piłą
DE Baumsäge mit astschere
RU Сучкорез штанговый с пилой
CZ Sřřřhač na větve s pilovým listem
HU Kőteles ágváágó
RO Fierastrau pt. pomi cu prelungitor
FR Système de scie à poulie
IT Taglio pista con sega
ES Podadera de palanca con sierra
CN 高枝锯



YATO 	L [mm]	
YT-8876	325	12

EN Hedge shears
 PL Nożyce do żywoplotu
 DE Heckenschere
 RU Кусторезы
 CZ Nožnice na živý plot
 HU Sívénnyvágó olló

RO Foarfeca pt. gard viu
 FR Cisaille à haie
 IT Cesioie per le siepe
 ES Tijeras para seto vivo
 CN 整篱剪

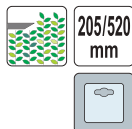

YATO	L [mm]	
YT-8821	520	24

EN Hedge shears
 PL Nożyce do żywoplotu
 DE Heckenschere
 RU Кусторезы
 CZ Nožnice na živý plot
 HU Sívénnyvágó olló

RO Foarfeca pt. gard viu
 FR Cisaille à haie
 IT Cesioie per le siepe
 ES Tijeras para seto vivo
 CN 整篱剪



YATO	L [mm]	
YT-8823	650	12

EN Grass shears
 PL Nożyce do trawy wielopozycyjne
 DE Handgrasschere
 RU Ножницы для стрижки травы
 CZ Nožnice na trávu
 HU Forgatható fűvirító olló
 RO Foarfeca pt. gazon
 FR Cisaille à gazon
 IT Cesioie per erba multifunzione
 ES Tijeras de cesped
 CN 草剪



YATO	L [mm]	
YT-8851	330	12/60

EN Grass shears
 PL Nożyce do trawy wielopozycyjne
 DE Handgrasschere
 RU Ножницы для стрижки травы
 CZ Nožnice na trávu
 HU Forgatható fűvirító olló
 RO Foarfeca pt. gazon
 FR Cisaille à gazon
 IT Cesioie per erba multifunzione
 ES Tijeras de cesped
 CN 草剪

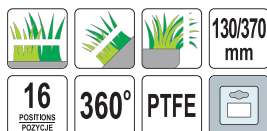

YATO	L [mm]	
YT-8853	370	6/72

EN Hedge shears
 PL Nożyce do żywoplotu
 DE Heckenschere
 RU Кусторезы
 HU Sívénnyvágó olló

RO Foarfeca pt. gard viu
 FR Cisaille à haie
 IT Cesioie per le siepe
 ES Tijeras para seto vivo
 CN 整篱剪

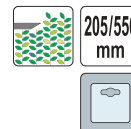

YATO	L [mm]	
YT-8822	550	12

EN Telescopic hedge shears
 PL Teleskopowe nożyce do żywoplotu
 DE Teleskopschere
 RU Кусторезы с телескопическими ручками
 HU Sívénnyvágó olló

RO Foarfeca pt. gard viu
 FR Cisaille télescopique à haie
 IT Cesioie telescopiche per siepe
 ES Tijeras para seto vivo
 CN 可伸缩整篱剪

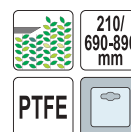

YATO	L [mm]	
YT-8824	690-890	6

EN Grass shears
 PL Nożyce do trawy wielopozycyjne
 DE Handgrasschere
 RU Ножницы для стрижки травы
 CZ Nožnice na trávu
 HU Forgatható fűvirító olló
 RO Foarfeca pt. gazon
 FR Cisaille à gazon
 IT Cesioie per erba multifunzione
 ES Tijeras de cesped
 CN 草剪

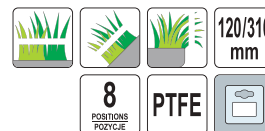

YATO	L [mm]	
YT-8852	310	6/24

EN Grass shears
 PL Nożyce do trawy wielopozycyjne
 DE Handgrasschere
 RU Ножницы для стрижки травы
 CZ Nožnice na trávu
 HU Forgatható fűvirító olló
 RO Foarfeca pt. gazon
 FR Cisaille à gazon
 IT Cesioie per erba multifunzione
 ES Tijeras de cesped
 CN 草剪

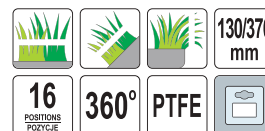

YATO	L [mm]	
YT-8854	370	6/72

EN Folding pruning saw
PL Piła ogrodnicza składana
DE Klappgartensäge
RU Пила садовая складная
CZ Skládací zahradní pilka
HU Összecsukható kerti fűrész
RO Fierastrau pliabil pt. curatat copaci
FR Scie à élaguer pliante
IT Sega da giardinaggio pieghevole
ES Sierra para jardín plegable
CN 折叠锯

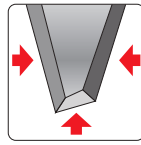

180 mm
7TPI
1.4 mm
HRC 53-60
SK5
ABS
TPR PP
LOCK BLOKADA



YATO	L [mm]	
YT-87725	180	12/48

EN Folding pruning saw
PL Piła ogrodnicza składana
DE Klappgartensäge
RU Пила садовая складная
CZ Skládací zahradní pilka
HU Összecsukható kerti fűrész
RO Fierastrau pliabil pt. curatat copaci
FR Scie à élaguer pliante
IT Sega da giardinaggio pieghevole
ES Sierra para jardín plegable
CN 折叠锯

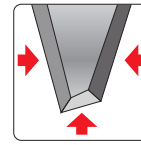

9TPI
1.2 mm
HRC 62-64
SK5
PTFE
ABS TPR



YATO	L [mm]	
YT-87730	180	12/48
YT-87731	210	12/48
YT-87732	250	12/48

EN Pruning saw with sheath
PL Piła ogrodnicza z kaburą
DE Gartensäge mit Holster
RU Пила садовая с кабурой
CZ Zahradní pilka s pouzdrzem
HU Kerti fűrész tokkal
RO Fierastrău pt. curatat copaci cu toc
FR Scie à élaguer avec étui
IT Sega da giardinaggio con fodero
ES Sierra para jardín con funda
CN 园林锯

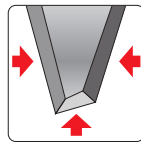

350 mm
7TPI
1.2 mm
HRC 62-64
SK5
PTFE
ABS TPR
SHEATH KABURA



YATO	L [mm]	
YT-87740	350	12/36

EN Curved pruning saw
PL Piła ogrodnicza zakrzywiona
DE Gebogene Gartensäge
RU Пила садовая с изогнутым полотном
CZ Zahradní pilka zahnutá
HU Ívelt kerti fűrész
RO Fierastrău curbat pt. curatat copaci
FR Scie à élaguer courbe
IT Sega da giardinaggio ricurva
ES Sierra para jardín curvada
CN 弯锯

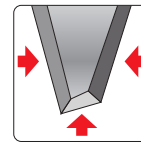

350 mm
7TPI
1.2 mm
HRC 62-64
SK5
PTFE
ABS TPR
SHEATH KABURA



YATO	L [mm]	
YT-87744	350	12/36

EN Transplanter
PL Lopatka
DE Blumenkelle
RU Сокор посадочный
CZ Lopatka
HU Ásó
RO Mini-lopată gradinarit
FR Transplantoir
IT Spatola
ES Paleta estrecha
CN 移植器

350 mm



YATO	L [mm]	
YT-8865	350	10/60

EN Rake
PL Grabki
DE Blumenrechen
RU Грабли
CZ Hračičky
HU Gereblye
RO Mini grebla
FR Râteau
IT Rastrelli
ES Rastrillo
CN 园艺耙

325 mm



YATO	L [mm]	
YT-8866	325	10/60

EN Hoe and cultivator
PL Motyczka z pazurkami
DE Kleinhacke
RU Рыхлитель комбинированный
CZ Molyčka s kultivátorem
HU Kerti villás kapa
RO Cultivator cu sapaliga
FR Serfolette
IT Zappa con artigli
ES Escanficador y azadilla
CN 园艺锄

310 mm



YATO	L [mm]	
YT-8867	310	10/60

EN Cultivator
PL Pazurki
DE Grubber
RU Рыхлитель
CZ Kultivátor
HU Kultivátor
RO Cultivator
FR Griffes piocheuse
IT Artigli
ES Escarifi cador
CN 园艺耙

420 mm



YATO	L [mm]	
YT-8868	420	10/60

EN Garden rake
PL Grabki wachlarzowe
DE Landschaftsbesen
RU Грабли веерные
CZ Hračičky
HU Kerti gereblye
RO Grebla de gradina
FR Râteau
IT Rastrelli ventilatore
ES Rastrillo de abanico de hojalata
CN 园艺耙

400 mm



YATO	L [mm]	
YT-8869	400	10/60

EN Transplanter
PL Łopatką
DE Blumenkelle
RU Сокор посадочный
CZ Lopatka
HU Ásó
RO Mini-lopată gradinarit
FR Transplantoir
IT Spatola
ES Paleta estrecha
CN 园艺铲

360 mm



YATO	L [mm]	
YT-8870	360	10/60

EN Transplanter
PL Łopatka
DE Blumenkelle
RU Сокор посадочный
CZ Lopatka
HU Ásó
RO Mini-lopata gradinarit
FR Transplantoir
IT Spatola
ES Paleta estrecha
CN 移植器

340 mm

CHROME PLATED CHROMO-WANE



YATO 

L [mm]



YT-8885

340

12/72

EN Transplanter
PL Łopatka
DE Blumenkelle
RU Сокор посадочный
CZ Lopatka
HU Ásó
RO Mini-lopata gradinarit
FR Transplantoir
IT Spatola
ES Paleta estrecha
CN 园艺铲

340 mm

CHROME PLATED CHROMO-WANE



YATO 

L [mm]



YT-8886

340

12/72

EN Hoe
PL Motyczka
DE Garten Handhacke
RU Мотыжка
CZ Motyčka
HU Kerti kapa
RO Sapalliga
FR Binette
IT Zappetta
ES Azadilla
CN 园艺锄

280 mm

CHROME PLATED CHROMO-WANE



YATO 

L [mm]



YT-8889

280

12/72

EN Cultivator
PL Pazurki
DE Grubber
RU Рыхлитель
CZ Kultivátor
HU Kultivátor
RO Cultivator
FR Griffes piocheuse
IT Artigli
ES Escarifi cador
CN 园艺耙

270 mm

CHROME PLATED CHROMO-WANE



YATO 

L [mm]



YT-8890

270

12/72

EN Rolling tiller
PL Spulchniacz
DE Rollflüger
RU Рыхлитель дисковый
CZ Kypřič půdy
HU Görgös talajlazító
RO Maruntitor pt. pamant
FR Émietteur
IT Coltivatore
ES Escarifi cador
CN 松土器

370 mm

CHROME PLATED CHROMO-WANE



YATO 

L [mm]



YT-8891

370

12/72

EN Hoe and cultivator
PL Motyczka z pazurkami
DE Kleinhacke
RU Рыхлитель комбинированный
CZ Motyčka s kultivátorem
HU Kerti villás kapa
RO Cultivator cu sapalliga
FR Serfouette
IT Zappa con artigli
ES Escarificador y azadilla
CN 园艺锄

320 mm

CHROME PLATED CHROMO-WANE



YATO 

L [mm]



YT-8892

320

12/72

EN Dibble
PL Pikownik ogrodniczy
DE Pflanzler
RU Конус посадочный
CZ Zahradnický přerýchovač
HU Kerti palántázó
RO Chitonag pt. grădină
FR Plantoir
IT Foraterra
ES Picadeor de jardin
CN 挖洞器



280 mm

SS STAINLESS STEEL



YATO 

L [mm]



YT-8894

280

10/60

EN Sharp spade
PL Szpadel ostry
DE Scharfer Spaten
RU Штыковая лопата
CZ Ryč špičatý
HU Hegyes ásó
RO Hârleț ascuțit
FR Bêche à bord pointu
IT Vanga affilata
ES Pala puntiaguda
CN 铁锹



120 cm

HRC 40-48

1050 Mn



YATO 

L [cm]



YT-86804

120

6

EN Flat spade
PL Szpadel prosty
DE Rodespaten
RU Заступ
CZ Ryč rovný
HU Egyenes ásó
RO Hârleț cu coadă
FR Bêche
IT Vanga dritta
ES Pala recta
CN 铁锹



120 cm

HRC 40-48

1050 Mn



YATO 

L [cm]



YT-86800

120

6

EN Coal shovel
PL Łopata węgłowa
DE Kohlschaufel
RU Лопата для угля
CZ Lopata na uhlí
HU Szénlapát
RO Lopata pt. carbune
FR Pelle à charbon
IT Pala per carbone
ES Pala para carbón
CN 铁锹



120 cm

HRC 40-48

1050 Mn



YATO 

L [cm]



YT-86801

120

6

EN Sand shovel
PL Lopata piaskowa
DE Sandschaufel
RU Лопата для песка
CZ Lopata na písek
HU Homoklapát
RO Lopată pt. nisip
FR Pelle à sable
IT Pala per sabbia
ES Pala para arena
CN 铁锹



120 cm
HRC 40-48
1050 Mn



YATO L [cm] 6
YT-86808 120 6

EN Digging fork
PL Widły
DE Grabegabel
RU Вилы
CZ Zahradnické vidlice
HU Vasvilla
RO Furcă pt. grădinărit
FR Fourche à bécher
IT Forchetta
ES Horca
CN 铁叉



120 cm



YATO L [cm] 6
YT-86805 120 6

EN Digging fork
PL Widły
DE Grabegabel
RU Вилы
CZ Zahradnické vidlice
HU Vasvilla
RO Furcă pt. grădinărit
FR Fourche à bécher
IT Forchetta
ES Horca
CN 铁叉



120 cm



YATO L [cm] 6
YT-86809 120 6

EN Weed puller
PL Wyrywacz chwastów
DE Unkrautentferner
RU Приспособление для вырывания сорняков
CZ Vytrhávač plevele
HU Gyomkihúzó

RO Dispozitiv de scos buruieni
FR Extracteur de mauvaises herbes
IT Estrattore di erbacce
ES Extractor de maleza
CN 移苗器

995 mm AI
PP



YATO L [mm] 6
YT-86840 995 6

EN Manual lawn leveling rake
PL Ręczny nivelator terenu
DE Rasenraker
RU Грабли для выравнивания газона
CZ Ruční nivelační brána
HU Gyep szintező
RO Grebla manuala pt. nivelarea gazonului
FR Niveleur de terrain manuel
IT Rastrello livellante
ES Rastrollo de nivelación de césped
CN 手动草坪平整器



60x25 cm

YATO 40
YT-86770 40

EN Manual lawn leveling rake
PL Ręczny nivelator terenu
DE Rasenraker
RU Грабли для выравнивания газона
CZ Ruční nivelační brána
HU Gyep szintező
RO Grebla manuala pt. nivelarea gazonului
FR Niveleur de terrain manuel
IT Rastrello livellante
ES Rastrollo de nivelación de césped
CN 手动草坪平整器



80x30 cm

YATO 30
YT-86771 30

EN Manual leveler with wheels
PL Nivelator terenu na kolach
DE Rasenraker mit Rädern
RU Ручной грайдер планировщик грунта
CZ Ruční nivelační brána na kolech
HU Kerekes szintező
RO Nivelator manual cu roti
FR Niveleur de terrain manuel sur roues
IT Rastrello livellante con ruote
ES Niveladora de suelo manual
CN 手动带车轮平整器



105 cm

YATO 10
YT-86780 10

EN Manual leveler with wheels
PL Nivelator terenu na kolach
DE Rasenraker mit Rädern
RU Ручной грайдер планировщик грунта
CZ Ruční nivelační brána na kolech
HU Kerekes szintező
RO Nivelator manual cu roti
FR Niveleur de terrain manuel sur roues
IT Rastrello livellante con ruote
ES Niveladora de suelo manual
CN 手动带车轮平整器



105-175 cm

YATO 6
YT-86781 6

EN Multiple holder
PL Wieszak na narzędzia
DE Werkzeughalter
RU Подвеска для инструмента
CZ Věšák na nářadí
HU Szerszámapasztó

RO Suport multiplu
FR Porte-outils
IT Portaattensili
ES Colgador para herramientas
CN 塑料挂架

18-32 mm x5 x6
320 g ABS TPR



YATO 40
YT-87650 40

YATO	page/stroņa	YATO	page/stroņa	YATO	page/stroņa	YATO	page/stroņa	YATO	page/stroņa	YATO	page/stroņa	YATO	page/stroņa	YATO	page/stroņa	YATO	page/stroņa
YT-00760	8	YT-02383	13	YT-0370	11	YT-04343	54	YT-04722	84	YT-0534	430	YT-05611	95	YT-06061	395	YT-0642	387
YT-00761	8	YT-02384	13	YT-0371	11	YT-04344	54	YT-0474	86	YT-05341	415	YT-05615	96	YT-06062	396	YT-0643	442
YT-00762	8	YT-02385	13	YT-0372	11	YT-04345	54	YT-04742	84	YT-05342	416	YT-0562	100	YT-06064	396	YT-0645	397
YT-00763	8	YT-02386	13	YT-0373	11	YT-04346	54	YT-0475	86	YT-05343	415	YT-0563	100	YT-0607	395	YT-0646	397
YT-00764	8	YT-02387	13	YT-0374	11	YT-04350	55	YT-04752	84	YT-05345	416	YT-05631	101	YT-0608	395	YT-0647	397
YT-00765	8	YT-02388	13	YT-0375	11	YT-04351	55	YT-0476	86	YT-05390	394	YT-05632	101	YT-06082	395	YT-06475	399
YT-00766	8	YT-02390	55	YT-0376	11	YT-04352	55	YT-04762	84	YT-05430	96	YT-05633	101	YT-06086	433	YT-06477	396
YT-00767	8	YT-02391	55	YT-0377	11	YT-04353	55	YT-0477	86	YT-05431	96	YT-05640	96	YT-06088	439	YT-0648	398
YT-00768	8	YT-02392	55	YT-0378	11	YT-04354	55	YT-04772	84	YT-05432	96	YT-05644	96	YT-0609	379	YT-0650	397
YT-00769	8	YT-02393	55	YT-0380	11	YT-04355	55	YT-0478	86	YT-05433	96	YT-05800	401	YT-0610	435	YT-0651	397
YT-0135	14	YT-02394	55	YT-0381	11	YT-04356	55	YT-04782	84	YT-05434	96	YT-05801	401	YT-06101	435	YT-0652	398
YT-0136	14	YT-02395	55	YT-0383	12	YT-04357	55	YT-04792	84	YT-05436	96	YT-05802	401	YT-0611	436	YT-0653	398
YT-0137	14	YT-02396	55	YT-0384	12	YT-04360	56	YT-0480	86	YT-05438	96	YT-05810	400	YT-0612	385	YT-06535	395
YT-0138	14	YT-02397	55	YT-0385	12	YT-04370	53	YT-0481	86	YT-05439	96	YT-05811	400	YT-06122	385	YT-06561	434
YT-01385	14	YT-02400	55	YT-0386	12	YT-04371	53	YT-04812	84	YT-05440	96	YT-05812	400	YT-06123	385	YT-0657	396
YT-0139	14	YT-0290	26	YT-0387	12	YT-04372	53	YT-0482	86	YT-05441	96	YT-05815	400	YT-0613	385	YT-0659	392
YT-0140	14	YT-0291	29	YT-0388	12	YT-04373	53	YT-04822	85	YT-05442	96	YT-05816	400	YT-0614	385	YT-06590	392
YT-0143	14	YT-0292	33	YT-0389	12	YT-04374	53	YT-0483	86	YT-05443	96	YT-05817	400	YT-0615	386	YT-0660	445
YT-01440	418	YT-0293	26	YT-0390	12	YT-04375	53	YT-04832	85	YT-05444	96	YT-05830	399	YT-06155	386	YT-0661	445
YT-01670	18	YT-0294	29	YT-0391	12	YT-04381	54	YT-0484	87	YT-05445	96	YT-0585	385	YT-06157	386	YT-06611	445
YT-01671	18	YT-0295	33	YT-0392	12	YT-04382	54	YT-0485	84	YT-05446	96	YT-05890	384	YT-0616	386	YT-06613	445
YT-01672	18	YT-0297	26	YT-0394	12	YT-04383	54	YT-0486	84	YT-05450	97	YT-05893	383	YT-06160	386	YT-0662	446
YT-01673	18	YT-0298	29	YT-03950	12	YT-04384	54	YT-0487	84	YT-05451	97	YT-05897	383	YT-061602	386	YT-06622	446
YT-01674	18	YT-0299	33	YT-03951	12	YT-04385	54	YT-0488	87	YT-05452	97	YT-0590	384	YT-06162	386	YT-0663	445
YT-01675	18	YT-0307	25	YT-03952	12	YT-04386	54	YT-0489	87	YT-05453	97	YT-0591	382	YT-06163	386	YT-06650	484
YT-01676	18	YT-0308	29	YT-03953	12	YT-04387	54	YT-0490	87	YT-05454	97	YT-0593	431	YT-06166	416	YT-06651	484
YT-01677	18	YT-0309	33	YT-03954	12	YT-04388	54	YT-0491	87	YT-05456	97	YT-05933	431	YT-06169	416	YT-06652	484
YT-01678	18	YT-0310	25	YT-03955	12	YT-04390	54	YT-0492	87	YT-05458	97	YT-05934	431	YT-0617	413	YT-06653	485
YT-01679	18	YT-0311	29	YT-03956	12	YT-04391	54	YT-0493	87	YT-05459	97	YT-0594	371	YT-06174	414	YT-06654	485
YT-0170	14	YT-0312	33	YT-0396	12	YT-04392	54	YT-0494	87	YT-05460	97	YT-0596	371	YT-06175	414	YT-06655	485
YT-0171	14	YT-0313	25	YT-0398	12	YT-04393	54	YT-0495	87	YT-05461	97	YT-05971	370	YT-06176	414	YT-06656	485
YT-0172	14	YT-0314	29	YT-0400	88	YT-04394	54	YT-0496	87	YT-05462	97	YT-05980	372	YT-0618	416	YT-06657	485
YT-0173	14	YT-0315	33	YT-0404	84	YT-04395	54	YT-0497	87	YT-05463	97	YT-0599	373	YT-06184	416	YT-06658	485
YT-0175	14	YT-0316	25	YT-0405	84	YT-04396	54	YT-0498	87	YT-05464	97	YT-05991	372	YT-06187	416	YT-06659	485
YT-01851	10	YT-0317	29	YT-04051	84	YT-04397	54	YT-0499	87	YT-05465	97	YT-05994	372	YT-0619	441	YT-06660	485
YT-01852	10	YT-0318	33	YT-04052	84	YT-04398	54	YT-0500	98	YT-05466	97	YT-05995	372	YT-0620	385	YT-06661	486
YT-01853	10	YT-0322	25	YT-0406	84	YT-04401	56	YT-0501	98	YT-05490	97	YT-05997	372	YT-06205	396	YT-06662	486
YT-01854	10	YT-0323	29	YT-0407	84	YT-04411	53	YT-0502	98	YT-05491	97	YT-0600	373	YT-06208	393	YT-06663	486
YT-01855	10	YT-0324	33	YT-0408	84	YT-04412	53	YT-0503	99	YT-05492	97	YT-06001	410	YT-0621	441	YT-06664	486
YT-01856	10	YT-0325	25	YT-0409	84	YT-04413	53	YT-0504	99	YT-05493	97	YT-06002	404	YT-0622	418	YT-06680	476
YT-01858	10	YT-0326	29	YT-0410	88	YT-04417	53	YT-0505	99	YT-05494	97	YT-06003	410	YT-0623	384	YT-0670	419
YT-01865	11	YT-0327	33	YT-0411	88	YT-04418	53	YT-0506	99	YT-05495	97	YT-06004	404	YT-0624	384	YT-0671	437
YT-01870	11	YT-0331	26	YT-0412	88	YT-04580	384	YT-0507	99	YT-05496	97	YT-06005	406	YT-06251	385	YT-0672	426
YT-01872	11	YT-03311	26	YT-0413	88	YT-04581	384	YT-0508	98	YT-05497	97	YT-06006	411	YT-06255	385	YT-06721	426
YT-01874	11	YT-03314	241	YT-0414	88	YT-0461	56	YT-0509	99	YT-05498	97	YT-06007	412	YT-06256	385	YT-06722	426
YT-01875	11	YT-03315	241	YT-0415	89	YT-04620	90	YT-0511	100	YT-05499	97	YT-06008	402	YT-0627	399	YT-0673	427
YT-01876	11	YT-03316	241	YT-0416	89	YT-04621	90	YT-0512	100	YT-05501	97	YT-06009	406	YT-06273	399	YT-0674	427
YT-01877	11	YT-03317	242	YT-0417	89	YT-04622	90	YT-05123	97	YT-05514	97	YT-06010	409	YT-06275	399	YT-0677	398
YT-01879	11	YT-03318	242	YT-0418	89	YT-04623	90	YT-0519	99	YT-05515	97	YT-06011	402	YT-06278	399	YT-06772	470
YT-0189	9	YT-0332	11	YT-0419	89	YT-04624	91	YT-0520	50	YT-05516	97	YT-06012	403	YT-0628	441	YT-06773	470
YT-01906	9	YT-0333	11	YT-0420	89	YT-04625	92	YT-0521	50	YT-05517	97	YT-06013	405	YT-06288	394	YT-06774	470
YT-01907	9	YT-0334	11	YT-0421	425	YT-04626	92	YT-05211	49	YT-05518	97	YT-06014	403	YT-0630	394	YT-06775	470
YT-01908	9	YT-0335	8	YT-04211	425	YT-04627	92	YT-05212	49	YT-05519	97	YT-06015	413	YT-06301	394	YT-06776	470
YT-01909	9	YT-0336	8	YT-04301	53	YT-04628	93	YT-05213	49	YT-05520	97	YT-06016	404	YT-06311	431	YT-06777	476
YT-0191	9	YT-0337	8	YT-04302	53	YT-04629	93	YT-05214	49	YT-05571	95	YT-06017	403	YT-06312	432	YT-06780	472
YT-0192	9	YT-0338	8	YT-04303	53	YT-04630	94	YT-05215	49	YT-05572	95	YT-060175	410	YT-06313	432	YT-06782	475
YT-0193	9	YT-0339	8	YT-04304	53	YT-04631	94	YT-05220	50	YT-05574	95	YT-060176	405	YT-06315	432	YT-06783	475
YT-0194	9	YT-0340	8	YT-04305	53	YT-04632	94	YT-05221	50	YT-05576	95	YT-06018	406	YT-06316	432	YT-067833	475
YT-0195	9	YT-0341	8	YT-04306	53	YT-04635	92	YT-05222	50	YT-05577	95	YT-06019	402	YT-0632	402	YT-06784	475
YT-0196	9	YT-0342	8	YT-04307	53	YT-04636	94	YT-05223	50	YT-05578	95	YT-0602	379	YT-06322	410	YT-06784	475
YT-0197	9	YT-0343	8	YT-04310	54	YT-04639	93	YT-05224	50	YT-05579	95	YT-06021	411	YT-06323	408	YT-067842	474
YT-0198	9	YT-0344	8	YT-04311	54	YT-04641	93	YT-05225	50	YT-05581	95	YT-06022	408	YT-06324	412	YT-06785	477
YT-0199	9	YT-0345	8	YT-04312	54	YT-04644	92	YT-05226	50	YT-05583	95	YT-06023	403	YT-06325	407	YT-06786	473
YT-0200	9	YT-0346	8	YT-04313	54	YT-04645	92	YT-05227	50	YT-05585	95	YT-06024	411	YT-06326	404	YT-06787	474
YT-0201	9	YT-0347	8	YT-04314	54	YT-0465	91	YT-05228	50	YT-05586	95	YT-06025	405	YT-06327	409	YT-06790	476
YT-0202	9	YT-0348	8	YT-04315	54	YT-0466	91	YT-05244	49	YT-05588	95	YT-06026	407	YT-06328	408	YT-06793	476
YT-0203	9	YT-0349	8	YT-04316	54	YT-0467	91	YT-05245	50	YT-05590	95	YT-060261	409	YT-0633	407	YT-0680	434
YT-0204	9	YT-0350	8	YT-04317	54	YT-04671	91	YT-05246	50	YT-05591	95	YT-060262	412	YT-06331	405	YT-06802	434
YT-0205	9	YT-0351	8	YT-04318	54	YT-0468	92	YT-05247	50	YT-05592	95	YT-06027	411	YT-06332	403	YT-06805	434

YATO	page/strona	YATO	page/strona	YATO	page/strona	YATO	page/strona	YATO	page/strona	YATO	page/strona	YATO	page/strona	YATO	page/strona	YATO	page/strona
YT-06860	474	YT-07063	375	YT-0817	430	YT-08556	612	YT-08942	347	YT-09540	320	YT-1035	63	YT-1136	64	YT-1240	31
YT-06862	472	YT-07065	375	YT-0818	430	YT-08557	612	YT-08950	492	YT-09544	320	YT-1036	63	YT-1138	64	YT-1241	32
YT-06864	472	YT-07067	337	YT-08195	413	YT-08558	608	YT-08960	564	YT-09545	320	YT-1037	63	YT-1141	64	YT-1242	32
YT-068641	471	YT-07068	337	YT-08196	413	YT-08559	613	YT-08970	564	YT-09564	321	YT-1038	63	YT-1142	64	YT-1243	32
YT-06865	470	YT-07069	337	YT-0820	370	YT-08567	613	YT-08973	566	YT-09571	321	YT-1039	63	YT-1143	64	YT-12439	32
YT-068652	471	YT-0707	374	YT-0821	370	YT-08568	613	YT-08974	566	YT-09575	321	YT-1040	63	YT-1146	64	YT-1244	32
YT-06866	480	YT-07071	375	YT-0822	370	YT-08569	613	YT-09000	356	YT-0959	321	YT-1041	63	YT-1148	64	YT-12445	32
YT-068661	480	YT-0708	374	YT-0823	370	YT-08570	613	YT-09002	354	YT-0960	322	YT-1042	63	YT-1150	64	YT-1246	31
YT-068667	480	YT-07082	375	YT-08231	370	YT-08571	613	YT-09003	354	YT-09615	322	YT-1043	63	YT-1155	65	YT-1247	31
YT-068668	481	YT-07083	374	YT-08235	370	YT-08579	614	YT-09004	355	YT-09618	322	YT-1044	63	YT-1157	69	YT-1248	31
YT-06867	481	YT-07084	374	YT-08236	370	YT-08580	612	YT-09002	356	YT-09620	322	YT-1045	63	YT-1160	65	YT-1249	31
YT-068671	481	YT-07087	456	YT-0824	370	YT-08581	611	YT-09032	355	YT-09632	324	YT-1046	63	YT-1161	65	YT-1250	31
YT-068672	481	YT-0709	375	YT-0825	370	YT-08582	611	YT-09033	355	YT-09633	324	YT-1047	63	YT-1162	65	YT-1251	31
YT-06868	480	YT-0710	375	YT-08253	370	YT-08587	612	YT-09061	357	YT-0965	324	YT-1048	63	YT-1163	65	YT-1252	32
YT-068683	478	YT-07101	375	YT-08254	370	YT-08588	612	YT-0907	364	YT-09675	324	YT-1049	63	YT-1164	65	YT-1253	429
YT-068684	479	YT-07102	375	YT-0826	370	YT-08590	615	YT-09071	364	YT-09676	324	YT-1050	63	YT-11641	65	YT-12531	429
YT-068685	479	YT-07110	375	YT-08280	448	YT-08591	615	YT-09072	364	YT-09695	327	YT-1052	63	YT-11671	65	YT-1254	429
YT-06869	483	YT-07115	376	YT-08295	446	YT-08592	615	YT-0908	364	YT-09702	327	YT-1054	63	YT-1168	65	YT-12541	429
YT-06870	478	YT-0712	376	YT-0830	446	YT-08593	615	YT-09091	347	YT-09703	327	YT-1055	63	YT-1169	66	YT-1255	31
YT-06871	471	YT-0715	376	YT-08302	446	YT-08594	615	YT-09092	347	YT-09715	326	YT-1056	442	YT-1175	66	YT-1258	31
YT-068711	472	YT-0716	457	YT-08304	446	YT-08595	615	YT-09093	347	YT-09717	326	YT-10563	442	YT-1176	66	YT-1259	31
YT-068713	471	YT-0717	457	YT-08305	446	YT-08596	615	YT-0910	364	YT-09730	325	YT-10564	442	YT-1177	66	YT-1260	37
YT-06872	471	YT-0718	457	YT-0831	446	YT-08597	614	YT-09101	366	YT-09738	325	YT-1060	63	YT-1178	66	YT-12671	48
YT-068721	471	YT-07190	338	YT-08312	446	YT-08598	616	YT-09102	366	YT-09739	325	YT-1061	63	YT-1179	66	YT-12681	39
YT-06873	473	YT-07191	338	YT-08320	447	YT-08599	616	YT-09104	367	YT-09740	325	YT-1062	63	YT-1180	66	YT-12691	39
YT-06874	474	YT-07195	337	YT-0835	447	YT-0860	445	YT-09107	366	YT-09741	325	YT-10630	62	YT-1183	66	YT-1270	30
YT-06875	473	YT-0730	26	YT-08353	447	YT-0862	492	YT-09108	366	YT-09742	325	YT-10632	62	YT-1184	66	YT-1271	30
YT-06876	477	YT-0731	29	YT-08354	447	YT-08625	495	YT-0911	364	YT-09743	227	YT-1064	64	YT-1185	66	YT-1272	30
YT-06877	477	YT-0732	33	YT-0836	391	YT-0863	493	YT-0913	355	YT-09744	227	YT-10640	64	YT-1186	66	YT-1273	30
YT-06878	477	YT-0733	26	YT-0837	391	YT-0864	493	YT-0914	356	YT-09745	227	YT-10642	67	YT-1187	66	YT-1274	30
YT-06879	477	YT-0735	33	YT-0838	389	YT-0865	493	YT-09152	354	YT-09746	227	YT-10643	67	YT-1188	66	YT-1275	30
YT-068791	477	YT-0750	72	YT-08390	428	YT-0866	493	YT-09155	354	YT-09747	227	YT-1065	68	YT-1189	66	YT-1276	30
YT-06880	476	YT-07500	72	YT-08391	428	YT-0867	493	YT-09158	569	YT-09748	227	YT-10652	67	YT-1191	66	YT-1277	30
YT-06881	476	YT-0751	72	YT-08392	428	YT-08677	493	YT-09159	568	YT-09749	227	YT-10653	69	YT-1193	66	YT-1278	30
YT-06882	475	YT-07511	72	YT-0840	428	YT-08678	493	YT-09160	570	YT-09750	227	YT-10654	67	YT-1194	66	YT-1279	30
YT-06883	473	YT-0754	73	YT-08403	428	YT-08679	493	YT-09161	569	YT-0980	323	YT-10655	69	YT-1196	66	YT-1280	30
YT-06884	474	YT-0760	72	YT-0841	390	YT-08680	365	YT-09162	568	YT-09803	323	YT-1066	68	YT-1197	66	YT-1281	30
YT-06885	474	YT-07601	72	YT-0842	390	YT-08681	365	YT-09163	567	YT-0981	323	YT-10662	68	YT-1198	66	YT-1282	30
YT-06888	473	YT-07605	72	YT-08422	387	YT-08682	365	YT-09164	567	YT-0982	323	YT-10663	68	YT-1199	67	YT-1283	30
YT-06890	478	YT-07607	72	YT-08425	387	YT-08690	365	YT-09165	568	YT-09860	323	YT-10664	68	YT-11995	67	YT-1284	30
YT-06891	478	YT-07609	72	YT-08426	387	YT-08707	447	YT-09166	568	YT-0990	327	YT-1067	63	YT-11998	67	YT-1285	30
YT-068911	478	YT-0761	73	YT-08428	387	YT-08710	495	YT-09167	567	YT-09901	328	YT-10671	66	YT-11999	66	YT-1286	30
YT-068912	478	YT-07611	72	YT-08429	387	YT-08711	495	YT-09168	565	YT-09904	327	YT-1068	68	YT-12000	370	YT-1289	30
YT-068913	479	YT-07612	72	YT-0843	80	YT-08721	494	YT-091681	565	YT-09910	328	YT-10681	68	YT-12005	402	YT-1291	30
YT-068914	480	YT-07641	72	YT-08431	388	YT-08722	494	YT-09169	567	YT-09911	328	YT-1069	68	YT-12007	394	YT-1292	30
YT-068915	479	YT-07642	72	YT-08432	388	YT-08723	494	YT-091691	568	YT-09912	328	YT-10691	68	YT-1201	30	YT-12930	31
YT-068920	480	YT-0770	73	YT-0844	391	YT-08780	448	YT-091692	567	YT-09913	328	YT-1070	64	YT-1202	30	YT-12931	31
YT-06895	479	YT-0771	73	YT-08442	391	YT-08790	448	YT-09170	566	YT-0994	326	YT-1071	64	YT-1203	30	YT-12932	31
YT-06896	479	YT-07711	73	YT-08443	391	YT-08791	448	YT-09171	566	YT-09944	326	YT-1072	64	YT-1204	30	YT-12933	31
YT-0690	376	YT-07712	72	YT-0845	392	YT-08792	448	YT-09173	569	YT-09945	327	YT-1073	64	YT-1205	30	YT-12934	31
YT-0691	376	YT-07730	72	YT-0846	392	YT-08793	448	YT-09174	569	YT-09955	326	YT-1074	64	YT-1206	30	YT-12935	31
YT-06912	376	YT-07731	72	YT-08461	392	YT-08795	448	YT-09175	568	YT-09958	200	YT-1075	64	YT-1207	30	YT-12936	31
YT-06913	376	YT-07735	72	YT-08462	393	YT-0880	448	YT-09177	564	YT-09959	200	YT-1076	64	YT-1208	30	YT-12937	31
YT-06914	376	YT-07736	72	YT-0847	391	YT-08802	448	YT-09178	565	YT-09990	330	YT-1077	64	YT-1209	30	YT-12938	31
YT-06919	376	YT-07740	73	YT-08474	391	YT-0882	368	YT-09179	565	YT-1000	62	YT-1078	64	YT-1210	30	YT-12939	31
YT-0692	456	YT-07741	73	YT-08477	391	YT-0883	368	YT-09180	565	YT-1001	62	YT-1079	64	YT-1211	30	YT-12940	31
YT-0693	456	YT-07743	73	YT-08490	615	YT-0884	368	YT-09181	565	YT-1002	62	YT-1080	64	YT-1212	30	YT-12941	31
YT-0694	456	YT-07752	73	YT-08495	605	YT-0885	368	YT-09182	564	YT-1003	62	YT-1082	64	YT-1213	30	YT-12942	31
YT-0695	456	YT-07753	73	YT-08496	605	YT-0886	368	YT-09183	566	YT-1004	62	YT-1083	64	YT-1214	30	YT-12943	31
YT-0696	456	YT-07762	73	YT-08500	607	YT-08872	368	YT-09184	566	YT-1005	62	YT-1084	64	YT-1215	30	YT-12944	31
YT-0697	456	YT-0782	74	YT-08502	607	YT-08873	368	YT-091844	567	YT-1006	62	YT-1085	64	YT-1216	30	YT-12945	31
YT-06972	456	YT-07822	74	YT-08504	609	YT-08874	368	YT-09185	569	YT-1007	62	YT-1086	64	YT-1217	30	YT-12946	31
YT-06977	376	YT-07830	74	YT-085051	610	YT-08900	367	YT-09190	570	YT-1008	62	YT-1088	64	YT-1218	30	YT-12947	31
YT-06980	455	YT-07831	74	YT-08507	609	YT-08901	367	YT-09191	570	YT-1009	62	YT-1091	64	YT-1219	30	YT-12948	31
YT-06983	455	YT-07832	74	YT-085081	609	YT-08902	367	YT-09201	339	YT-1010	62	YT-1092	64	YT-1220	30	YT-12949	31
YT-06985	455	YT-07835	74	YT-08509	607	YT-08903	367	YT-09202	339	YT-1011	62	YT-1093	64	YT-1221	31	YT-1295	32
YT-06987	455	YT-07836	74	YT-08511	611	YT-08904	367	YT-09203	339	YT-1012	62	YT-1096	64	YT-1222	31	YT-12951	32
YT-0699	457	YT-0800	443	YT-08513	610	YT-08905	368	YT-09211	340	YT-1013	62	YT-1100	64	YT-1223	31	YT-1296	28

YATO	page/strona	YATO	page/strona	YATO	page/strona	YATO	page/strona	YATO	page/strona	YATO	page/strona	YATO	page/strona	YATO	page/strona		
YT-2396	335	YT-24966	253	YT-25863	81	YT-28150	116	YT-2944	177	YT-30460	309	YT-3252	165	YT-3372	176	YT-34713	207
YT-2397	335	YT-24970	253	YT-25900	78	YT-28153	116	YT-2945	177	YT-30461	309	YT-3253	165	YT-3373	176	YT-35850	219
YT-2398	335	YT-24971	253	YT-25901	78	YT-2817	116	YT-2946	177	YT-30464	309	YT-3254	165	YT-3374	176	YT-35851	219
YT-2399	335	YT-24972	253	YT-25902	78	YT-28174	116	YT-2950	177	YT-30465	309	YT-3255	165	YT-3377	176	YT-35852	219
YT-2401	335	YT-24980	253	YT-25903	78	YT-2818	116	YT-2951	177	YT-30471	310	YT-3256	165	YT-3380	176	YT-35853	219
YT-2402	335	YT-24983	252	YT-25904	78	YT-2819	116	YT-2952	177	YT-30473	310	YT-3257	165	YT-3381	176	YT-35854	219
YT-2403	335	YT-24990	252	YT-25905	78	YT-2820	116	YT-2953	177	YT-30475	310	YT-3258	165	YT-33830	180	YT-35855	219
YT-2404	335	YT-24991	252	YT-25906	78	YT-2821	116	YT-2954	177	YT-30477	310	YT-3259	165	YT-33831	180	YT-35856	219
YT-2405	335	YT-25000	252	YT-25907	78	YT-2822	116	YT-2955	177	YT-30479	310	YT-3261	167	YT-33832	180	YT-35857	219
YT-2406	335	YT-25001	252	YT-25908	78	YT-2823	116	YT-2956	177	YT-30491	310	YT-3262	167	YT-33833	180	YT-35858	219
YT-2407	335	YT-25002	252	YT-25909	78	YT-2824	116	YT-2961	178	YT-30492	310	YT-3263	167	YT-33834	180	YT-35859	219
YT-24091	336	YT-25003	252	YT-25910	78	YT-28245	116	YT-2962	178	YT-30500	310	YT-3264	167	YT-33837	180	YT-35860	219
YT-24092	336	YT-25004	252	YT-25911	78	YT-2825	116	YT-2963	178	YT-30503	310	YT-3265	167	YT-33860	166	YT-35861	219
YT-24093	336	YT-25005	252	YT-25912	78	YT-2826	116	YT-2964	178	YT-30600	292	YT-3266	167	YT-33861	166	YT-35862	219
YT-24094	336	YT-25010	133	YT-25913	78	YT-28263	116	YT-2965	178	YT-30610	292	YT-3267	167	YT-33862	166	YT-35863	219
YT-24095	336	YT-25015	133	YT-25914	78	YT-2827	116	YT-2966	178	YT-30700	294	YT-3268	167	YT-33863	166	YT-35864	219
YT-24100	336	YT-25030	252	YT-25920	78	YT-2828	116	YT-2967	178	YT-3071	294	YT-3269	167	YT-33864	166	YT-35865	219
YT-24101	336	YT-2510	379	YT-25921	78	YT-28283	117	YT-2969	178	YT-3072	294	YT-3270	167	YT-33865	166	YT-35866	219
YT-24102	336	YT-25105	378	YT-25922	78	YT-28290	116	YT-2970	178	YT-3073	294	YT-3271	167	YT-33866	166	YT-35867	219
YT-24103	336	YT-2511	378	YT-25923	78	YT-28293	116	YT-2971	178	YT-3074	294	YT-3272	167	YT-33867	166	YT-35868	219
YT-24130	336	YT-2512	378	YT-25924	78	YT-28294	117	YT-2973	178	YT-3076	294	YT-3273	167	YT-33868	166	YT-35869	219
YT-24201	333	YT-2513	378	YT-25925	78	YT-28295	117	YT-2975	178	YT-3077	294	YT-3274	167	YT-33869	166	YT-35870	219
YT-24202	333	YT-2514	377	YT-25926	78	YT-28300	127	YT-2976	178	YT-3078	294	YT-3275	167	YT-33870	166	YT-35871	219
YT-24203	333	YT-25145	392	YT-25927	78	YT-28312	128	YT-2977	178	YT-3079	294	YT-3276	167	YT-33873	166	YT-35872	219
YT-24204	333	YT-2515	377	YT-25928	78	YT-28313	128	YT-2978	178	YT-3081	294	YT-3277	167	YT-33920	201	YT-35873	219
YT-24205	333	YT-2516	377	YT-25929	78	YT-28320	128	YT-2979	178	YT-3082	294	YT-3278	167	YT-33921	201	YT-35880	219
YT-24206	333	YT-2517	377	YT-25930	78	YT-2861	128	YT-2980	180	YT-3083	294	YT-3279	167	YT-33922	201	YT-35881	219
YT-24207	333	YT-2518	377	YT-25931	78	YT-2862	128	YT-2981	180	YT-3084	294	YT-3280	167	YT-33923	201	YT-3590	219
YT-24208	333	YT-2519	377	YT-25932	78	YT-28630	128	YT-2982	180	YT-30900	283	YT-3281	167	YT-33930	201	YT-3591	219
YT-24209	333	YT-2520	377	YT-25933	78	YT-28631	128	YT-2983	180	YT-3101	198	YT-3282	167	YT-33931	201	YT-35970	256
YT-24220	333	YT-2521	377	YT-25934	78	YT-2864	127	YT-2984	180	YT-3102	198	YT-3283	167	YT-33932	201	YT-35980	259
YT-24221	333	YT-2522	377	YT-25940	78	YT-2865	449	YT-2985	180	YT-3103	198	YT-3284	167	YT-33933	201	YT-35981	259
YT-24224	333	YT-2523	377	YT-25941	78	YT-2866	449	YT-2986	180	YT-3106	198	YT-3285	167	YT-33934	201	YT-35982	259
YT-24225	333	YT-25331	393	YT-25942	78	YT-28667	449	YT-2987	180	YT-3107	198	YT-3286	167	YT-33935	201	YT-35983	259
YT-24230	333	YT-2535	440	YT-25943	78	YT-28919	492	YT-2988	180	YT-3108	198	YT-3287	167	YT-33950	201	YT-3600	256
YT-24231	333	YT-2536	440	YT-25950	78	YT-28920	492	YT-2989	180	YT-31091	198	YT-3288	167	YT-33951	201	YT-36007	256
YT-24232	333	YT-25380	438	YT-25951	78	YT-28921	492	YT-2990	180	YT-31092	198	YT-3289	167	YT-33960	201	YT-36011	256
YT-24233	334	YT-25383	438	YT-25952	78	YT-28950	169	YT-2991	180	YT-31093	198	YT-3290	167	YT-33961	201	YT-36012	256
YT-24234	334	YT-25384	438	YT-25953	78	YT-28951	169	YT-2992	180	YT-31095	198	YT-3291	167	YT-33970	201	YT-36013	256
YT-24235	334	YT-25390	380	YT-25954	78	YT-28952	169	YT-2993	180	YT-31096	198	YT-3292	167	YT-33971	201	YT-36060	256
YT-24236	334	YT-25391	381	YT-25955	78	YT-28953	169	YT-2994	180	YT-31097	198	YT-3293	167	YT-33972	202	YT-36070	256
YT-24237	334	YT-2540	380	YT-25956	78	YT-28954	169	YT-2995	180	YT-31290	199	YT-3294	167	YT-3400	202	YT-3609	257
YT-24238	334	YT-2541	381	YT-25957	78	YT-28955	169	YT-2996	180	YT-3130	199	YT-3295	167	YT-3401	202	YT-36091	257
YT-24240	334	YT-25411	381	YT-25958	78	YT-28956	169	YT-2997	180	YT-31303	198	YT-3296	167	YT-3402	202	YT-36092	257
YT-24241	334	YT-25412	381	YT-25959	78	YT-28957	169	YT-29980	314	YT-31310	198	YT-3297	167	YT-3403	202	YT-36095	257
YT-24242	334	YT-25413	381	YT-25960	78	YT-28958	169	YT-29982	314	YT-3133	199	YT-3298	167	YT-3404	202	YT-3610	257
YT-24243	334	YT-25415	388	YT-25961	78	YT-28959	169	YT-29984	314	YT-3134	199	YT-3299	167	YT-3405	202	YT-36112	257
YT-24244	335	YT-2542	382	YT-25965	79	YT-28960	169	YT-3001	311	YT-31343	199	YT-3300	167	YT-3407	202	YT-36119	258
YT-24245	335	YT-2543	382	YT-25966	79	YT-28961	169	YT-3002	311	YT-31350	218	YT-33010	182	YT-3408	202	YT-3612	257
YT-24246	335	YT-2544	440	YT-25967	79	YT-28962	169	YT-3003	311	YT-3150	199	YT-33011	182	YT-3409	202	YT-36125	258
YT-24250	335	YT-2546	440	YT-25968	79	YT-28963	169	YT-3004	311	YT-3160	200	YT-33015	182	YT-3410	202	YT-36127	258
YT-24301	452	YT-2547	440	YT-25971	80	YT-28964	169	YT-3005	311	YT-3161	200	YT-33021	168	YT-3411	203	YT-36128	258
YT-2449	110	YT-25472	440	YT-25972	82	YT-28965	169	YT-30060	311	YT-31612	200	YT-33022	168	YT-3412	203	YT-36129	258
YT-2450	111	YT-25480	393	YT-25980	79	YT-28966	169	YT-30061	311	YT-3163	200	YT-33023	168	YT-3413	203	YT-36140	257
YT-2451	111	YT-25483	393	YT-25981	79	YT-28967	169	YT-30062	311	YT-3200	199	YT-3303	174	YT-3414	203	YT-36150	258
YT-2452	111	YT-25760	81	YT-25982	80	YT-2900	238	YT-30063	311	YT-3201	199	YT-3304	174	YT-3415	203	YT-36171	339
YT-2453	110	YT-25802	81	YT-25985	78	YT-29001	238	YT-30064	311	YT-3202	199	YT-3306	174	YT-3416	203	YT-36177	339
YT-2459	111	YT-25803	81	YT-25986	78	YT-29003	238	YT-30310	311	YT-3203	199	YT-3308	174	YT-3417	203	YT-3618	339
YT-2460	111	YT-25804	81	YT-25987	78	YT-29010	238	YT-30311	311	YT-3204	199	YT-3311	174	YT-3421	203	YT-36200	259
YT-2461	112	YT-25805	81	YT-25988	78	YT-29011	238	YT-30312	311	YT-3221	200	YT-3313	174	YT-3445	203	YT-36201	259
YT-2463	112	YT-25806	81	YT-25989	78	YT-29012	238	YT-30313	311	YT-3222	200	YT-3315	174	YT-3460	200	YT-36202	259
YT-2466	112	YT-25807	81	YT-25990	78	YT-29013	238	YT-30071	311	YT-3223	200	YT-3317	174	YT-3461	200	YT-36203	259
YT-2468	112	YT-25808	81	YT-25991	78	YT-29014	238	YT-30072	311	YT-3224	200	YT-3318	174	YT-3462	200	YT-36420	473
YT-2469	112	YT-25809	81	YT-25992	78	YT-29016	238	YT-30073	311	YT-3230	200	YT-3321	174	YT-34680	204	YT-36451	258
YT-2473	111	YT-25810	81	YT-25993	78	YT-29017	238	YT-30074	311	YT-3231	200	YT-3322	174	YT-34681	204	YT-36452	258
YT-2476	111	YT-25811	81	YT-25994	78	YT-29018	238	YT-3022	311	YT-3232	200	YT-3323	174	YT-34682	204	YT-36453	258
YT-24780	242	YT-25831	81	YT-25995	78	YT-29019	238	YT-3023	311	YT-3233	200	YT-3324	174	YT-34683	205	YT-36454	258
YT-24790	250	YT-25832	81	YT-25996	78												

YATO	page/strona	YATO	page/strona	YATO	page/strona	YATO	page/strona	YATO	page/strona	YATO	page/strona	YATO	page/strona	YATO	page/strona	YATO	page/strona
YT-47143	141	YT-47860	232	YT-51961	287	YT-5416	292	YT-5533	358	YT-58967	466	YT-60422	168	YT-60795	188	YT-61726	182
YT-47144	141	YT-47868	233	YT-51962	287	YT-5417	292	YT-55331	363	YT-5901	295	YT-60423	168	YT-6080	188	YT-61727	182
YT-47145	141	YT-47870	232	YT-51963	287	YT-54230	293	YT-5534	358	YT-5902	295	YT-60424	168	YT-6081	188	YT-61729	182
YT-47146	141	YT-47872	232	YT-51964	287	YT-54233	294	YT-55341	363	YT-5904	295	YT-60425	168	YT-6082	188	YT-6180	222
YT-47147	140	YT-47873	232	YT-51970	287	YT-54300	287	YT-5535	359	YT-5905	295	YT-60426	168	YT-6083	188	YT-6181	222
YT-47148	140	YT-47880	233	YT-51971	287	YT-54310	287	YT-55351	363	YT-5911	466	YT-60427	168	YT-6085	188	YT-6182	222
YT-47149	140	YT-47881	233	YT-51973	287	YT-54313	287	YT-5536	359	YT-5913	466	YT-60428	168	YT-6086	188	YT-6183	222
YT-47150	141	YT-47882	233	YT-5200	282	YT-54320	287	YT-55361	363	YT-5914	466	YT-60429	168	YT-60871	188	YT-6184	222
YT-47151	141	YT-47883	233	YT-5202	282	YT-54400	286	YT-5537	360	YT-59155	192	YT-60430	168	YT-60872	188	YT-6185	222
YT-47152	141	YT-47884	233	YT-5203	282	YT-54500	288	YT-55371	363	YT-59156	192	YT-60431	168	YT-60905	189	YT-6186	222
YT-47155	141	YT-47890	232	YT-5204	282	YT-54501	288	YT-5538	360	YT-59164	191	YT-60432	168	YT-60907	189	YT-6187	222
YT-47160	218	YT-47892	232	YT-5207	282	YT-54502	288	YT-55381	363	YT-59165	191	YT-60433	168	YT-6091	189	YT-6188	222
YT-47161	218	YT-47893	232	YT-5209	282	YT-54503	288	YT-5539	361	YT-59166	191	YT-60434	168	YT-6093	189	YT-6189	222
YT-47170	141	YT-47894	232	YT-5210	282	YT-54504	288	YT-55391	363	YT-59167	191	YT-60435	168	YT-6095	189	YT-6190	222
YT-47195	173	YT-47895	232	YT-5212	282	YT-54505	288	YT-5540	361	YT-59168	192	YT-60436	168	YT-6097	189	YT-6191	222
YT-47197	173	YT-47896	233	YT-5214	283	YT-54540	288	YT-55401	363	YT-59169	192	YT-60441	169	YT-6099	189	YT-6192	222
YT-4720	171	YT-47900	233	YT-5218	285	YT-54541	288	YT-5541	360	YT-59170	192	YT-60442	169	YT-6101	190	YT-6193	222
YT-47200	171	YT-47901	233	YT-52220	281	YT-54542	288	YT-55411	363	YT-59175	192	YT-60443	169	YT-61025	190	YT-6194	222
YT-4721	171	YT-47902	233	YT-52221	281	YT-54543	288	YT-5542	360	YT-59176	192	YT-60444	169	YT-6103	190	YT-6219	225
YT-47212	171	YT-47910	233	YT-52222	281	YT-54544	288	YT-55421	363	YT-59177	192	YT-60445	169	YT-6104	190	YT-6220	225
YT-4722	171	YT-47911	233	YT-52223	281	YT-54550	288	YT-5543	357	YT-59178	192	YT-60446	169	YT-6105	190	YT-6221	225
YT-4723	171	YT-47912	233	YT-52224	281	YT-54551	288	YT-55433	358	YT-59179	192	YT-60447	169	YT-6107	190	YT-6222	225
YT-4730	144	YT-47913	233	YT-52230	281	YT-54552	288	YT-5544	359	YT-59180	192	YT-6045	187	YT-6110	190	YT-62228	222
YT-47301	144	YT-47920	232	YT-52231	281	YT-54553	288	YT-55451	361	YT-59181	192	YT-6046	187	YT-6112	190	YT-62229	222
YT-47303	144	YT-47921	232	YT-52232	281	YT-54554	288	YT-55453	361	YT-59182	192	YT-60480	189	YT-6113	190	YT-6223	222
YT-47304	144	YT-47922	232	YT-52233	281	YT-54560	288	YT-55455	359	YT-59183	192	YT-60482	189	YT-6132	190	YT-62231	222
YT-47330	172	YT-47930	234	YT-52234	281	YT-54561	288	YT-55456	358	YT-59184	192	YT-60484	189	YT-6116	190	YT-62238	222
YT-47331	171	YT-47931	234	YT-52237	281	YT-54562	288	YT-55457	361	YT-59185	192	YT-60488	188	YT-6120	190	YT-62239	222
YT-47335	172	YT-47932	234	YT-52240	282	YT-54563	288	YT-55458	360	YT-5920	190	YT-60489	188	YT-6121	190	YT-6224	222
YT-47336	172	YT-47933	234	YT-52241	282	YT-54564	288	YT-55462	360	YT-5923	190	YT-6050	188	YT-6124	190	YT-62241	222
YT-47340	172	YT-47940	234	YT-52242	282	YT-54580	288	YT-55463	358	YT-5924	190	YT-6052	188	YT-6125	190	YT-62243	222
YT-47341	172	YT-47945	234	YT-52243	282	YT-54581	288	YT-55464	359	YT-5925	190	YT-60522	188	YT-6126	190	YT-62244	222
YT-47344	172	YT-48200	187	YT-52244	282	YT-54582	288	YT-55465	362	YT-5927	190	YT-6053	188	YT-6132	191	YT-62245	222
YT-47345	172	YT-48201	187	YT-52245	281	YT-54583	288	YT-55466	362	YT-5930	191	YT-60533	188	YT-6133	191	YT-62246	222
YT-47348	172	YT-48202	187	YT-52246	281	YT-54590	288	YT-55469	359	YT-5932	191	YT-6055	188	YT-6136	190	YT-62248	222
YT-47370	173	YT-48203	187	YT-52247	281	YT-54591	288	YT-55471	362	YT-5933	191	YT-6056	188	YT-6137	190	YT-62249	222
YT-47372	173	YT-48204	187	YT-5226	285	YT-54592	288	YT-55472	358	YT-5935	191	YT-6057	188	YT-61395	225	YT-6225	222
YT-47375	173	YT-48205	187	YT-5228	285	YT-54593	288	YT-55473	358	YT-5947	190	YT-60577	188	YT-6140	223	YT-62251	222
YT-47377	173	YT-48206	187	YT-5230	285	YT-54620	288	YT-55474	361	YT-59951	186	YT-6058	188	YT-6141	223	YT-62258	222
YT-47380	173	YT-4901	9	YT-52310	285	YT-54621	288	YT-55476	362	YT-59952	186	YT-60581	188	YT-6142	223	YT-62259	222
YT-47385	173	YT-4902	9	YT-52311	285	YT-54622	288	YT-55477	362	YT-59955	186	YT-60582	188	YT-6143	224	YT-6226	222
YT-47496	210	YT-4903	9	YT-52312	285	YT-54640	288	YT-55478	362	YT-59961	186	YT-60583	188	YT-6144	224	YT-62261	222
YT-47497	210	YT-4904	9	YT-52313	285	YT-54641	288	YT-55479	363	YT-59962	186	YT-60590	188	YT-6145	224	YT-62268	222
YT-4750	210	YT-4905	9	YT-52314	285	YT-54642	288	YT-55480	359	YT-59965	186	YT-60591	188	YT-6146	224	YT-62269	222
YT-4751	210	YT-4906	9	YT-52317	281	YT-54670	289	YT-55481	359	YT-59971	186	YT-6060	188	YT-6147	223	YT-6227	222
YT-47511	210	YT-4907	9	YT-52320	286	YT-54730	289	YT-55500	460	YT-59972	186	YT-6061	188	YT-6148	223	YT-62271	222
YT-47518	210	YT-4908	9	YT-5234	285	YT-54741	289	YT-55503	460	YT-59975	186	YT-6062	188	YT-6149	223	YT-6228	222
YT-4752	210	YT-4909	9	YT-5237	285	YT-54742	289	YT-55510	461	YT-59981	186	YT-60621	188	YT-6150	224	YT-6229	222
YT-4755	210	YT-4910	9	YT-5240	285	YT-54743	289	YT-55511	461	YT-59982	186	YT-60622	188	YT-6151	224	YT-6230	222
YT-47553	213	YT-4911	9	YT-5242	285	YT-54744	289	YT-55512	461	YT-59985	186	YT-60627	189	YT-6152	223	YT-6231	222
YT-47554	213	YT-4912	9	YT-5243	285	YT-54750	279	YT-55513	461	YT-60003	186	YT-60628	189	YT-6153	223	YT-6232	222
YT-47555	213	YT-4937	16	YT-5245	285	YT-54895	295	YT-5555	332	YT-60004	186	YT-6063	188	YT-6154	223	YT-62328	222
YT-47565	211	YT-4945	16	YT-5247	286	YT-5490	295	YT-55556	468	YT-6002	186	YT-60631	189	YT-6155	224	YT-62329	222
YT-47568	211	YT-5038	12	YT-52471	286	YT-5491	295	YT-55557	468	YT-6003	186	YT-60633	188	YT-6156	224	YT-6233	222
YT-4757	211	YT-5130	112	YT-52472	286	YT-5492	295	YT-55565	469	YT-6004	186	YT-60634	188	YT-6160	224	YT-62331	222
YT-4758	211	YT-51303	113	YT-52473	286	YT-5493	295	YT-55567	469	YT-6005	186	YT-60635	188	YT-6161	223	YT-62338	222
YT-4759	211	YT-5131	113	YT-52550	217	YT-5494	295	YT-55568	469	YT-6012	186	YT-60636	188	YT-6162	223	YT-62339	222
YT-47593	211	YT-51311	113	YT-5260	280	YT-5496	295	YT-55570	469	YT-6013	186	YT-6065	188	YT-6163	223	YT-6234	222
YT-4761	212	YT-51312	113	YT-5261	280	YT-5497	296	YT-55580	468	YT-6014	186	YT-60652	188	YT-6164	223	YT-62341	222
YT-47612	212	YT-51320	113	YT-5262	280	YT-5499	296	YT-55581	468	YT-6015	186	YT-6066	188	YT-6165	223	YT-62348	222
YT-4763	212	YT-5140	113	YT-52621	280	YT-5500	296	YT-55582	468	YT-6016	186	YT-60665	188	YT-61678	225	YT-62349	222
YT-4764	212	YT-5141	113	YT-52622	263	YT-5501	296	YT-55600	467	YT-6017	186	YT-6067	188	YT-61679	225	YT-6235	222
YT-47658	213	YT-5142	113	YT-52740	281	YT-5502	296	YT-55601	467	YT-6022	186	YT-6068	188	YT-61680	225	YT-62351	222
YT-4766	212	YT-51450	259	YT-52760	280	YT-55027	296	YT-55670	460	YT-6023	186	YT-60682	188	YT-61681	225	YT-62358	222
YT-4767	212	YT-51451	259	YT-52780	280	YT-5503	296	YT-55675	460	YT-6024	186	YT-60685	188	YT-61700	181	YT-62359	222
YT-4768	212	YT-51452	259	YT-52788	221	YT-55033	296	YT-55690	455	YT-6025	186	YT-60686	188	YT-61701	181	YT-6236	222
YT-4769	212	YT-51470	261	YT-52790	282	YT-5504	296	YT-55691	455	YT-6030	187	YT-60687	188	YT-61			

YATO	page/strona	YATO	page/strona	YATO	page/strona	YATO	page/strona	YATO	page/strona	YATO	page/strona	YATO	page/strona	YATO	page/strona	YATO	page/strona	YATO	page/strona	YATO	page/strona
YT-6281	140	YT-64251	151	YT-6741	262	YT-70565	264	YT-7105	302	YT-73011	420	YT-7371	574	YT-74510	583	YT-74949	582				
YT-6282	139	YT-64252	151	YT-67421	262	YT-70566	264	YT-71070	302	YT-73012	421	YT-7376	574	YT-74551	583	YT-74970	581				
YT-62822	139	YT-64253	151	YT-67422	262	YT-70567	264	YT-71071	302	YT-7302	424	YT-73760	574	YT-74551	583	YT-74971	581				
YT-62823	139	YT-64254	151	YT-6743	262	YT-70568	264	YT-71072	302	YT-73022	421	YT-73761	574	YT-7456	583	YT-74972	581				
YT-62824	139	YT-64255	151	YT-67433	262	YT-70569	264	YT-71073	302	YT-73023	422	YT-73765	575	YT-7458	583	YT-74980	581				
YT-62825	139	YT-64256	151	YT-67441	262	YT-70570	264	YT-71075	302	YT-73024	421	YT-73766	575	YT-74520	583	YT-74981	581				
YT-62826	139	YT-64257	151	YT-6745	262	YT-70571	264	YT-71076	302	YT-73025	420	YT-7377	575	YT-74521	583	YT-74982	581				
YT-62827	139	YT-64258	151	YT-67460	262	YT-70580	264	YT-71077	302	YT-73030	422	YT-73780	576	YT-7460	580	YT-75001	215				
YT-62828	139	YT-64262	151	YT-67470	263	YT-70581	264	YT-7110	302	YT-73031	422	YT-73810	576	YT-7461	580	YT-75002	215				
YT-62840	140	YT-64263	151	YT-6750	263	YT-70582	264	YT-7111	302	YT-73032	421	YT-7382	576	YT-74612	580	YT-75003	215				
YT-62900	221	YT-64270	150	YT-6751	262	YT-70583	264	YT-7112	302	YT-73040	439	YT-73830	576	YT-7462	584	YT-7504	216				
YT-62907	221	YT-64271	150	YT-67520	263	YT-70584	264	YT-71150	303	YT-73045	439	YT-73831	576	YT-74621	584	YT-7505	216				
YT-62910	221	YT-64272	150	YT-6753	262	YT-70585	264	YT-71151	303	YT-73050	422	YT-73832	576	YT-74624	583	YT-7506	216				
YT-62930	276	YT-64275	150	YT-6754	262	YT-70586	264	YT-71153	303	YT-73055	423	YT-73840	576	YT-74625	585	YT-7507	216				
YT-6330	209	YT-64276	150	YT-6755	263	YT-70587	264	YT-71155	303	YT-7306	424	YT-73842	576	YT-74626	585	YT-75071	216				
YT-6331	209	YT-64277	150	YT-67560	263	YT-70588	264	YT-71156	303	YT-73065	427	YT-73845	269	YT-7463	584	YT-75072	216				
YT-6332	209	YT-64278	150	YT-67570	263	YT-70630	264	YT-7126	302	YT-7307	420	YT-73855	269	YT-74630	584	YT-75101	216				
YT-6333	209	YT-64300	150	YT-67571	263	YT-70631	264	YT-7127	302	YT-73072	420	YT-73861	269	YT-74631	583	YT-7511	216				
YT-6334	209	YT-64307	150	YT-67573	263	YT-70632	264	YT-7128	302	YT-73077	131	YT-73921	490	YT-74632	584	YT-7512	216				
YT-6335	209	YT-64320	151	YT-67574	263	YT-70633	264	YT-7129	302	YT-73078	131	YT-73924	491	YT-74633	584	YT-75121	216				
YT-6336	209	YT-6440	150	YT-67580	286	YT-70634	264	YT-7130	302	YT-73079	483	YT-73929	491	YT-74635	584	YT-75122	216				
YT-6337	209	YT-6441	150	YT-67583	286	YT-70635	264	YT-7131	302	YT-73080	129	YT-73930	490	YT-74636	584	YT-75123	215				
YT-6338	209	YT-6442	150	YT-68002	184	YT-70636	264	YT-71540	303	YT-73081	129	YT-73931	491	YT-74637	585	YT-75124	216				
YT-6339	209	YT-6443	150	YT-68005	183	YT-70637	264	YT-71541	303	YT-73083	130	YT-73932	490	YT-74638	585	YT-75140	218				
YT-6340	209	YT-6444	150	YT-68006	183	YT-70638	264	YT-71570	303	YT-73084	130	YT-73933	491	YT-74639	577	YT-7520	215				
YT-6341	209	YT-6445	150	YT-68007	184	YT-70639	264	YT-71571	303	YT-73085	130	YT-73934	491	YT-746391	577	YT-75201	215				
YT-6343	209	YT-6446	150	YT-6801	185	YT-70650	264	YT-71572	303	YT-73086	131	YT-73935	491	YT-74640	577	YT-7524	217				
YT-6344	209	YT-6447	150	YT-6803	185	YT-70651	264	YT-71580	303	YT-73087	131	YT-73970	585	YT-746418	577	YT-7525	217				
YT-6345	209	YT-6448	150	YT-6854	449	YT-70652	264	YT-71581	303	YT-73089	130	YT-73971	585	YT-746419	577	YT-75260	216				
YT-6346	209	YT-6449	150	YT-6855	449	YT-70653	264	YT-71582	303	YT-730893	130	YT-73972	585	YT-74642	577	YT-75261	216				
YT-6349	209	YT-6450	150	YT-6862	449	YT-70654	264	YT-71650	308	YT-73090	131	YT-73973	585	YT-74645	577	YT-75262	217				
YT-6351	209	YT-6451	150	YT-6863	449	YT-70655	264	YT-71655	308	YT-73091	131	YT-73974	585	YT-74647	577	YT-7527	217				
YT-6353	209	YT-6452	150	YT-6903	132	YT-70656	264	YT-71700	303	YT-73092	131	YT-73975	585	YT-74650	577	YT-7528	217				
YT-6354	209	YT-6453	150	YT-6907	132	YT-70657	264	YT-71701	303	YT-73093	131	YT-7400	561	YT-74651	578	YT-7529	217				
YT-6355	209	YT-6454	150	YT-6916	132	YT-70658	264	YT-71702	303	YT-73094	130	YT-74001	560	YT-74652	578	YT-7530	217				
YT-6356	209	YT-64551	292	YT-6925	297	YT-70659	264	YT-7200	306	YT-73096	130	YT-74002	560	YT-74654	578	YT-7531	217				
YT-6358	209	YT-64552	292	YT-692501	297	YT-7070	303	YT-72003	306	YT-73097	131	YT-74008	571	YT-74655	578	YT-7532	215				
YT-6359	209	YT-65000	153	YT-6926	297	YT-7071	303	YT-72004	306	YT-7310	425	YT-74009	571	YT-74658	578	YT-7534	215				
YT-6360	209	YT-65001	153	YT-692603	297	YT-70713	304	YT-7201	306	YT-7311	425	YT-74050	447	YT-74659	578	YT-75360	218				
YT-63701	252	YT-65002	153	YT-692612	297	YT-70715	304	YT-72090	307	YT-7312	425	YT-74051	447	YT-74660	578	YT-75370	218				
YT-63702	252	YT-65003	153	YT-6927	297	YT-70720	303	YT-72093	307	YT-73122	307	YT-74060	579	YT-74661	578	YT-75460	220				
YT-63703	252	YT-65006	153	YT-69280	298	YT-70721	303	YT-72100	313	YT-73126	307	YT-74070	560	YT-74662	578	YT-75461	220				
YT-63704	252	YT-65007	153	YT-69281	298	YT-70722	303	YT-72101	313	YT-73127	307	YT-74071	560	YT-746628	578	YT-75464	220				
YT-63705	252	YT-65008	153	YT-69285	298	YT-70723	303	YT-72102	313	YT-73129	308	YT-7409	561	YT-74663	578	YT-75465	220				
YT-63740	252	YT-6501	152	YT-69286	298	YT-70724	303	YT-72106	313	YT-73131	129	YT-7410	561	YT-74664	578	YT-75467	220				
YT-63951	150	YT-6502	152	YT-69287	298	YT-70725	304	YT-72107	313	YT-73137	128	YT-7413	561	YT-746648	578	YT-7550	220				
YT-63952	150	YT-6503	152	YT-69290	298	YT-70726	304	YT-72108	313	YT-73138	129	YT-7414	561	YT-74665	578	YT-7551	220				
YT-63953	150	YT-6504	152	YT-69291	298	YT-70727	304	YT-72115	313	YT-73140	302	YT-74141	561	YT-74666	578	YT-7560	217				
YT-63954	150	YT-65048	152	YT-69930	298	YT-70730	218	YT-72116	313	YT-73141	302	YT-7416	562	YT-74667	578	YT-7561	217				
YT-63955	150	YT-65049	152	YT-69931	298	YT-70740	306	YT-72120	313	YT-73200	129	YT-7417	562	YT-74668	578	YT-7600	214				
YT-63956	150	YT-6505	152	YT-69932	298	YT-70770	306	YT-72121	313	YT-73201	129	YT-74172	562	YT-74670	577	YT-7601	214				
YT-63957	150	YT-6506	152	YT-69940	297	YT-70771	306	YT-72122	313	YT-73350	423	YT-7419	562	YT-74699	577	YT-76031	214				
YT-63958	150	YT-65071	153	YT-7000	260	YT-70772	306	YT-72125	313	YT-73460	453	YT-7420	562	YT-7470	577	YT-76040	214				
YT-6401	150	YT-65072	153	YT-7001	260	YT-70780	304	YT-72126	313	YT-73462	453	YT-74218	579	YT-74719	577	YT-76041	214				
YT-6402	150	YT-65073	153	YT-70020	260	YT-70781	304	YT-72127	313	YT-73470	453	YT-74220	579	YT-7472	577	YT-76042	215				
YT-6403	150	YT-65080	152	YT-70021	260	YT-70782	304	YT-72140	314	YT-7349	452	YT-74221	579	YT-74728	577	YT-76043	215				
YT-6404	150	YT-65081	152	YT-7003	260	YT-70783	304	YT-72141	314	YT-7350	452	YT-74225	580	YT-74729	577	YT-76050	214				
YT-6405	150	YT-65082	152	YT-7004	261	YT-70786	304	YT-7220	313	YT-73521	453	YT-74227	580	YT-7473	577	YT-76051	214				
YT-6406	150	YT-65085	153	YT-7005	260	YT-70787	304	YT-7221	313	YT-7360	574	YT-74229	580	YT-74739	577	YT-76052	214				
YT-6407	150	YT-6510	250	YT-7007	260	YT-70791	305	YT-7222	313	YT-73602	574	YT-74230	580	YT-7474	577	YT-76080	225				
YT-6408	150	YT-6511	250	YT-7011	261	YT-70792	305	YT-7223	313	YT-73603	575	YT-74231	580	YT-74751	576	YT-76085	225				
YT-6409	150	YT-6512	250	YT-7022	261	YT-70794	305	YT-72300	307	YT-7361	574	YT-74235	579	YT-74752	576	YT-76086	225				
YT-6410	150	YT-6513	250	YT-7023	261	YT-70796	306	YT-72301	307	YT-73611	575	YT-74236	580	YT-74753	576	YT-76087	225				
YT-64111	150	YT-65136	153	YT-7024	261	YT-70797	306	YT-72302	307	YT-73612	575	YT-74241	579	YT-74754	576	YT-76101	228				
YT-64112	150	YT-6581	105	YT-7025	261	YT-7080	305	YT-72303	307	YT-73613	575	YT-742411	579	YT-74755	576	YT-76103	228				
YT-64113	150	YT-6582	105	YT-7026	261	YT-7081	305	YT-72305	307	YT-73614	575	YT-74242	579	YT-74756	576	YT-76105	228				
YT-6412	150																				

YATO	page/strona	YATO	page/strona	YATO	page/strona	YATO	page/strona	YATO	page/strona	YATO	page/strona	YATO	page/strona	YATO	page/strona		
YT-7810	86	YT-79250	597	YT-8003	144	YT-80287	595	YT-80531	587	YT-80734	588	YT-80928	593	YT-8174	132	YT-82187	507
YT-7811	86	YT-79251	597	YT-8004	144	YT-80288	595	YT-80532	587	YT-80735	588	YT-80929	593	YT-8177	132	YT-82188	507
YT-7812	86	YT-79252	597	YT-8005	144	YT-80289	595	YT-80533	587	YT-80736	588	YT-80930	593	YT-81775	602	YT-82189	200
YT-78130	85	YT-79253	597	YT-8006	144	YT-8029	594	YT-80534	587	YT-80737	588	YT-80931	593	YT-81808	606	YT-82190	532
YT-78131	85	YT-79254	597	YT-80070	145	YT-80290	596	YT-80535	587	YT-80738	588	YT-80932	593	YT-81809	606	YT-82192	524
YT-78132	85	YT-79255	597	YT-80071	145	YT-80291	596	YT-80536	587	YT-80739	588	YT-80933	593	YT-81811	603	YT-82194	524
YT-78133	85	YT-79360	594	YT-80072	145	YT-80292	596	YT-80537	587	YT-80740	588	YT-80934	593	YT-818141	604	YT-82196	516
YT-78134	85	YT-79361	594	YT-80073	145	YT-80293	596	YT-80538	587	YT-80741	588	YT-80935	593	YT-818151	604	YT-82200	516
YT-78135	85	YT-79362	594	YT-80080	145	YT-80294	596	YT-80552	586	YT-80750	588	YT-80936	593	YT-818161	604	YT-82206	525
YT-78136	85	YT-79363	594	YT-80081	145	YT-8030	596	YT-80553	586	YT-80751	588	YT-80937	593	YT-818171	604	YT-82207	525
YT-78141	85	YT-79364	594	YT-80082	145	YT-8031	596	YT-80554	586	YT-80752	588	YT-80938	593	YT-81819	605	YT-82220	529
YT-78142	85	YT-79365	594	YT-8011	144	YT-8032	596	YT-80555	586	YT-80753	588	YT-80939	593	YT-81820	605	YT-82223	529
YT-78143	85	YT-79420	593	YT-8012	144	YT-8033	596	YT-80556	586	YT-80754	588	YT-80940	593	YT-81821	605	YT-82230	525
YT-78144	85	YT-79421	593	YT-80130	145	YT-8034	596	YT-80557	586	YT-80755	588	YT-80941	593	YT-818221	602	YT-82240	525
YT-78145	85	YT-79422	593	YT-80140	591	YT-80395	592	YT-80558	586	YT-80756	588	YT-80955	596	YT-818231	602	YT-82250	248
YT-78146	85	YT-79423	593	YT-80141	591	YT-80396	592	YT-80559	586	YT-80757	588	YT-80956	596	YT-818241	602	YT-82251	248
YT-78147	85	YT-79424	593	YT-80142	591	YT-80397	592	YT-80560	586	YT-80758	588	YT-80957	596	YT-818251	602	YT-82267	523
YT-78151	85	YT-79425	593	YT-80143	591	YT-80398	592	YT-80572	586	YT-80783	589	YT-80958	596	YT-818271	603	YT-82274	523
YT-78152	85	YT-79430	593	YT-80144	591	YT-80399	592	YT-80573	586	YT-80784	589	YT-80959	596	YT-818291	603	YT-82281	525
YT-78153	85	YT-79431	593	YT-80145	591	YT-80400	592	YT-80574	586	YT-80785	589	YT-80960	598	YT-818381	603	YT-82285	533
YT-78154	85	YT-79432	593	YT-80146	595	YT-80401	595	YT-80575	586	YT-80786	589	YT-80961	598	YT-818391	603	YT-82288	533
YT-78155	85	YT-79433	593	YT-80147	595	YT-80402	595	YT-80576	586	YT-80787	589	YT-80962	598	YT-81855	606	YT-82291	533
YT-78156	85	YT-79434	593	YT-80148	595	YT-80403	595	YT-80577	586	YT-80788	589	YT-80963	598	YT-81856	606	YT-82292	533
YT-78340	589	YT-79435	593	YT-80149	595	YT-80404	595	YT-80578	586	YT-80789	589	YT-80964	598	YT-81860	606	YT-82293	533
YT-78341	589	YT-79440	594	YT-80150	595	YT-80405	595	YT-80579	586	YT-80790	589	YT-81000	618	YT-81900	602	YT-82294	533
YT-78342	589	YT-79441	594	YT-80151	595	YT-80406	595	YT-80580	586	YT-80791	589	YT-81001	618	YT-81901	602	YT-82295	534
YT-78343	589	YT-79442	594	YT-80152	597	YT-80407	598	YT-80583	586	YT-80794	588	YT-81002	618	YT-81902	602	YT-82296	534
YT-79040	593	YT-79443	594	YT-80153	597	YT-80408	598	YT-80584	586	YT-80795	588	YT-81003	618	YT-81903	602	YT-82301	534
YT-79041	593	YT-79444	594	YT-80154	597	YT-80409	598	YT-80585	586	YT-80796	588	YT-81025	618	YT-81953	525	YT-82303	272
YT-79042	593	YT-79445	594	YT-80155	597	YT-80410	598	YT-80586	586	YT-80797	588	YT-81026	618	YT-81954	526	YT-82304	272
YT-79043	593	YT-79520	591	YT-80156	597	YT-80411	598	YT-80587	586	YT-80798	588	YT-81027	618	YT-81955	526	YT-82305	272
YT-79044	593	YT-79521	591	YT-80157	597	YT-80412	598	YT-80588	586	YT-80799	588	YT-81028	618	YT-81980	518	YT-82306	272
YT-79045	593	YT-79522	591	YT-80158	592	YT-80460	586	YT-80589	586	YT-80800	588	YT-81030	618	YT-81983	518	YT-82307	272
YT-79050	594	YT-79523	591	YT-80159	592	YT-80461	586	YT-80590	586	YT-80801	588	YT-81031	618	YT-82001	519	YT-82320	532
YT-79051	594	YT-79524	591	YT-80160	592	YT-80462	586	YT-80591	586	YT-80802	588	YT-81032	618	YT-82002	519	YT-82330	526
YT-79052	594	YT-79525	591	YT-80161	592	YT-80463	586	YT-80620	587	YT-80820	588	YT-81052	619	YT-82007	511	YT-82332	527
YT-79053	594	YT-79530	590	YT-80162	592	YT-80464	586	YT-80621	587	YT-80841	586	YT-81053	619	YT-82015	515	YT-82333	527
YT-79054	594	YT-79531	590	YT-80163	592	YT-80465	586	YT-80622	587	YT-80842	588	YT-81054	619	YT-82020	444	YT-82334	527
YT-79055	594	YT-79532	590	YT-80164	595	YT-80466	586	YT-80623	587	YT-80843	588	YT-8106	619	YT-82021	444	YT-82335	527
YT-79060	594	YT-79533	590	YT-80165	595	YT-80467	586	YT-80624	587	YT-80844	588	YT-8107	619	YT-82034	516	YT-82336	527
YT-79061	594	YT-79534	590	YT-80166	595	YT-80468	586	YT-80625	587	YT-80845	588	YT-8108	619	YT-82036	517	YT-82337	527
YT-79062	594	YT-79535	590	YT-80167	595	YT-80469	586	YT-80626	587	YT-80846	588	YT-81121	618	YT-82037	517	YT-82340	526
YT-79063	594	YT-79540	590	YT-80168	595	YT-80470	586	YT-80627	587	YT-80847	588	YT-81122	618	YT-82044	517	YT-82341	526
YT-79064	594	YT-79541	590	YT-80169	595	YT-80471	586	YT-80628	587	YT-80848	588	YT-8116	618	YT-82045	517	YT-82350	527
YT-79065	594	YT-79542	590	YT-80170	597	YT-80488	587	YT-80629	587	YT-80849	588	YT-81162	618	YT-82055	521	YT-82353	232
YT-79070	594	YT-79543	590	YT-80171	597	YT-80489	587	YT-80630	587	YT-808701	589	YT-8120	619	YT-82060	517	YT-82354	232
YT-79071	594	YT-79544	590	YT-80172	597	YT-80490	587	YT-80631	587	YT-808702	589	YT-81220	466	YT-82063	517	YT-82355	527
YT-79072	594	YT-79545	590	YT-80173	597	YT-80491	587	YT-80632	587	YT-808703	589	YT-81221	466	YT-82071	518	YT-82360	510
YT-79073	594	YT-79550	590	YT-80174	597	YT-80492	587	YT-80633	587	YT-808704	589	YT-81240	618	YT-82080	511	YT-82361	510
YT-79074	594	YT-79551	590	YT-80175	597	YT-80493	587	YT-80634	587	YT-808705	589	YT-81241	618	YT-82097	511	YT-82380	524
YT-79075	594	YT-79552	590	YT-80176	592	YT-80494	587	YT-80635	587	YT-808706	589	YT-81242	618	YT-82098	512	YT-82390	524
YT-79200	591	YT-79553	590	YT-80177	592	YT-80495	587	YT-80636	587	YT-808707	589	YT-81300	617	YT-82099	512	YT-82395	515
YT-79201	591	YT-79554	590	YT-80178	592	YT-80496	587	YT-80637	587	YT-808708	589	YT-81301	617	YT-82100	511	YT-82396	515
YT-79202	591	YT-79555	590	YT-80179	592	YT-80497	587	YT-80638	587	YT-808709	589	YT-81302	617	YT-82101	512	YT-82401	534
YT-79203	591	YT-79560	590	YT-80180	592	YT-80498	587	YT-80639	587	YT-80881	589	YT-81440	481	YT-821023	512	YT-82402	534
YT-79204	591	YT-79561	590	YT-80181	592	YT-80499	587	YT-80640	587	YT-80882	589	YT-81441	482	YT-821024	512	YT-82403	534
YT-79205	591	YT-79562	590	YT-80182	595	YT-80500	587	YT-80641	587	YT-80883	589	YT-81442	482	YT-82104	512	YT-82430	271
YT-79210	590	YT-79563	590	YT-80183	595	YT-80501	587	YT-80642	587	YT-80884	589	YT-81443	482	YT-82105	513	YT-82431	271
YT-79211	590	YT-79564	590	YT-80184	595	YT-80502	587	YT-80643	587	YT-80885	589	YT-81450	482	YT-82110	513	YT-82433	271
YT-79212	590	YT-79565	590	YT-80185	595	YT-80503	587	YT-80644	587	YT-80886	589	YT-81451	481	YT-82118	518	YT-82434	271
YT-79213	590	YT-79710	598	YT-80186	595	YT-80504	587	YT-80645	587	YT-80887	589	YT-81452	482	YT-82122	518	YT-82435	271
YT-79214	590	YT-79711	598	YT-80187	595	YT-80505	587	YT-80646	587	YT-80888	589	YT-81453	482	YT-82123	518	YT-82436	271
YT-79215	590	YT-79712	598	YT-80188	597	YT-80506	588	YT-80647	587	YT-80900	592	YT-81454	482	YT-82127	519	YT-82437	271
YT-79216	590	YT-79713	598	YT-80189	597	YT-80507	588	YT-80648	587	YT-80901	592	YT-81460	482	YT-82131	519	YT-82438	271
YT-79217	590	YT-79714	598	YT-80190	597	YT-80508	588	YT-80649	587	YT-80902	592	YT-81461	483	YT-82133	519	YT-82439	271
YT-79218	590	YT-79715	598	YT-80191	597	YT-80509	588	YT-80650	588	YT-8090							

YATO	page/storna	YATO	page/storna	YATO	page/storna	YATO	page/storna	YATO	page/storna	YATO	page/storna	YATO	page/storna	YATO	page/storna	YATO	page/storna
YT-82469	267	YT-828138	544	YT-83052	462	YT-83361	229	YT-83354	226	YT-84895	549	YT-85027	556	YT-85741	531	YT-8889	634
YT-82510	268	YT-82814	506	YT-83060	463	YT-83362	229	YT-83355	226	YT-84901	549	YT-85030	556	YT-85742	532	YT-8890	634
YT-82512	267	YT-82815	506	YT-83061	463	YT-83363	229	YT-83356	226	YT-84910	549	YT-85031	556	YT-85743	532	YT-8891	634
YT-82514	268	YT-82816	522	YT-83062	463	YT-83364	229	YT-83357	226	YT-84914	551	YT-85032	556	YT-85744	531	YT-8892	634
YT-82516	267	YT-82817	522	YT-83080	463	YT-83365	229	YT-83358	226	YT-84915	551	YT-85035	556	YT-85745	532	YT-8894	634
YT-82520	268	YT-82818	506	YT-83081	463	YT-83366	229	YT-83380	231	YT-84916	551	YT-85036	556	YT-85750	532	YT-8900	638
YT-82525	267	YT-82819	506	YT-83082	463	YT-83371	229	YT-83801	231	YT-84917	551	YT-85037	556	YT-85800	547	YT-8955	624
YT-82526	268	YT-82822	507	YT-83085	464	YT-83372	229	YT-83802	231	YT-84918	551	YT-85040	556	YT-85803	547	YT-8956	624
YT-82530	269	YT-82823	507	YT-8310	464	YT-83373	229	YT-83803	231	YT-84919	551	YT-85041	556	YT-85910	539	YT-8957	624
YT-82531	269	YT-82824	507	YT-83101	464	YT-83374	229	YT-83804	231	YT-84921	552	YT-85042	556	YT-85915	539	YT-8958	624
YT-82532	269	YT-82826	507	YT-8311	464	YT-83375	229	YT-83805	231	YT-84923	551	YT-85051	557	YT-85930	540	YT-8959	625
YT-82540	268	YT-82827	507	YT-83113	465	YT-83376	229	YT-83806	231	YT-84925	551	YT-85060	557	YT-86211	540	YT-8960	625
YT-82541	268	YT-82828	507	YT-83114	465	YT-83381	229	YT-83807	231	YT-84927	551	YT-85061	557	YT-86220	540	YT-8963	625
YT-82542	268	YT-828293	507	YT-83130	484	YT-83382	229	YT-83808	231	YT-84928	552	YT-85062	557	YT-86240	548	YT-8964	625
YT-82550	528	YT-828294	507	YT-83140	483	YT-83383	229	YT-8400	226	YT-84929	552	YT-85065	557	YT-86770	635	YT-8965	624
YT-82553	528	YT-828295	507	YT-83141	483	YT-83384	229	YT-8401	226	YT-849299	551	YT-85066	557	YT-86771	635	YT-8966	624
YT-82555	528	YT-828296	508	YT-83142	483	YT-83385	229	YT-8402	226	YT-84930	551	YT-85067	557	YT-86780	635	YT-8967	624
YT-82560	528	YT-82830	541	YT-83143	484	YT-83386	229	YT-8403	226	YT-849301	551	YT-85075	557	YT-86781	635	YT-8968	625
YT-82562	528	YT-82831	541	YT-83144	484	YT-83390	230	YT-8404	226	YT-84931	551	YT-85111	550	YT-86800	634	YT-8970	622
YT-82563	528	YT-82832	543	YT-83145	483	YT-83391	230	YT-8405	226	YT-849311	552	YT-85121	550	YT-86801	634	YT-8971	622
YT-82564	528	YT-82833	543	YT-83146	483	YT-83392	230	YT-8406	226	YT-849329	552	YT-85135	550	YT-86804	634	YT-8972	622
YT-82565	529	YT-828331	542	YT-83147	484	YT-83393	230	YT-8407	226	YT-84933	552	YT-85141	550	YT-86805	635	YT-8973	623
YT-82566	529	YT-828332	542	YT-83148	484	YT-83394	230	YT-8408	226	YT-849331	552	YT-85142	550	YT-86808	635	YT-8974	623
YT-82567	529	YT-828333	543	YT-83151	464	YT-83395	230	YT-8409	226	YT-849332	552	YT-85150	550	YT-86809	635	YT-8975	623
YT-82568	529	YT-828334	543	YT-83152	464	YT-83396	230	YT-8410	226	YT-849333	552	YT-85155	550	YT-86840	635	YT-8976	623
YT-82595	520	YT-82834	543	YT-83153	464	YT-83397	230	YT-8411	226	YT-84934	552	YT-85160	548	YT-87650	635	YT-8977	623
YT-82596	520	YT-82835	543	YT-83160	227	YT-83398	230	YT-8412	226	YT-84935	551	YT-85161	548	YT-87725	633	YT-8978	623
YT-82597	520	YT-828353	543	YT-83161	227	YT-83399	230	YT-8413	226	YT-849351	552	YT-85162	548	YT-87730	633	YT-8979	622
YT-82600	520	YT-828355	542	YT-83162	227	YT-83400	230	YT-8414	226	YT-849355	551	YT-85170	534	YT-87731	633	YT-8984	626
YT-82601	520	YT-828356	542	YT-83163	227	YT-83401	230	YT-8415	226	YT-84936	552	YT-85175	540	YT-87732	633	YT-8985	626
YT-82604	520	YT-82836	541	YT-83164	227	YT-83430	230	YT-8416	226	YT-84937	552	YT-85176	540	YT-87740	633	YT-8986	626
YT-82607	521	YT-82837	541	YT-83165	227	YT-83431	230	YT-8417	226	YT-84938	552	YT-85177	540	YT-87744	633	YT-8987	626
YT-82700	268	YT-828375	542	YT-83166	227	YT-83432	230	YT-8418	226	YT-849381	551	YT-85179	540	YT-87790	628	YT-8991	626
YT-82701	268	YT-828377	542	YT-83167	227	YT-83433	230	YT-8441	226	YT-849382	551	YT-85180	548	YT-8791	628	YT-8993	627
YT-8271	269	YT-828378	542	YT-83168	227	YT-83434	230	YT-8442	226	YT-849383	551	YT-85182	547	YT-8800	627	YT-9940	623
YT-8272	269	YT-828390	541	YT-83169	227	YT-83435	230	YT-8443	226	YT-84939	553	YT-85200	546	YT-8801	627	YT-9941	623
YT-8273	269	YT-828391	541	YT-83183	227	YT-83436	230	YT-8444	226	YT-849395	553	YT-85205	546	YT-8802	627	YT-9950	616
YT-82742	269	YT-82854	504	YT-83184	227	YT-83437	230	YT-8445	226	YT-84940	553	YT-85208	547	YT-8805	627	YT-99501	616
YT-82743	269	YT-82880	505	YT-83185	227	YT-83438	230	YT-8446	226	YT-849405	553	YT-85220	545	YT-8807	628	YT-99520	616
YT-82744	269	YT-82881	505	YT-83186	227	YT-83451	230	YT-8447	226	YT-84941	553	YT-85221	545	YT-8808	628	YT-99530	616
YT-82751	508	YT-82888	505	YT-83187	227	YT-83452	230	YT-8448	226	YT-84942	553	YT-85222	545	YT-8809	628	YT-99531	617
YT-82753	508	YT-82889	505	YT-83188	227	YT-83453	230	YT-8449	226	YT-84943	553	YT-85223	545	YT-8811	628	YT-99532	617
YT-82755	508	YT-82894	505	YT-83221	227	YT-83454	230	YT-8450	226	YT-84944	553	YT-85224	545	YT-8815	628	YT-99536	617
YT-82760	504	YT-82895	505	YT-83222	227	YT-83455	230	YT-8451	226	YT-849441	553	YT-85225	545	YT-8816	628	YT-99570	617
YT-82765	505	YT-82901	499	YT-83223	227	YT-83456	230	YT-8452	226	YT-849449	553	YT-85230	546	YT-8817	628	YT-99571	617
YT-82770	509	YT-82902	500	YT-83224	227	YT-83457	230	YT-8453	226	YT-84945	553	YT-85234	546	YT-88180	629	YT-99700	535
YT-82772	509	YT-829021	500	YT-83225	227	YT-83458	230	YT-8454	226	YT-849451	553	YT-85281	539	YT-88182	629	YT-99705	535
YT-82780	501	YT-82903	500	YT-83227	228	YT-834581	231	YT-8455	226	YT-849452	553	YT-85283	539	YT-88183	629	YT-99710	535
YT-82781	501	YT-82904	500	YT-83228	228	YT-834582	231	YT-8456	226	YT-849453	553	YT-85290	510	YT-88185	629	YT-99720	536
YT-82782	501	YT-82905	499	YT-83229	228	YT-834583	231	YT-845803	230	YT-849470	553	YT-85291	510	YT-88186	629	YT-99730	536
YT-82783	501	YT-82909	500	YT-83230	228	YT-834584	231	YT-845813	230	YT-849472	553	YT-85300	537	YT-88190	629	YT-99733	536
YT-82784	501	YT-82910	500	YT-83231	228	YT-834585	231	YT-845823	230	YT-849474	553	YT-85301	538	YT-88191	629	YT-99740	536
YT-82786	501	YT-82912	500	YT-83232	228	YT-834586	231	YT-845833	230	YT-849475	553	YT-85330	537	YT-8821	632	YT-99743	536
YT-82787	501	YT-82920	509	YT-83233	228	YT-834587	231	YT-845843	230	YT-849477	553	YT-85333	538	YT-8822	632	YT-99801	622
YT-82788	501	YT-82922	509	YT-83235	228	YT-834588	231	YT-845853	230	YT-849479	553	YT-85341	538	YT-8823	632	YT-99802	622
YT-82789	501	YT-82924	508	YT-83236	228	YT-834589	231	YT-845863	230	YT-84948	553	YT-85343	538	YT-8824	632	YT-99803	622
YT-82790	502	YT-82925	508	YT-83237	228	YT-834591	231	YT-846003	230	YT-84949	553	YT-85349	537	YT-8831	630	YT-99804	622
YT-82791	502	YT-82933	510	YT-83238	228	YT-834592	231	YT-846013	230	YT-849495	553	YT-85350	537	YT-8832	630	YT-99810	622
YT-82792	502	YT-82940	510	YT-83239	228	YT-834593	231	YT-846023	230	YT-84950	553	YT-85360	539	YT-8833	630	YT-99811	622
YT-82794	502	YT-82950	453	YT-83260	191	YT-834594	231	YT-846033	230	YT-84951	553	YT-85370	539	YT-8834	630	YT-99812	622
YT-82795	502	YT-82955	507	YT-83261	191	YT-834595	231	YT-846043	230	YT-849529	553	YT-85395	538	YT-8835	630	YT-99813	622
YT-82796	502	YT-82956	507	YT-83262	191	YT-834596	231	YT-846053	230	YT-84953	553	YT-85401	537	YT-8836	631	YT-99814	623
YT-82797	502	YT-82961	605	YT-83263	191	YT-834597	231	YT-846063	230	YT-84954	553	YT-85402	537	YT-8838	631	YT-99815	623
YT-82800	502	YT-82970	513	YT-83264	191	YT-834598	231	YT-846113	227	YT-84956	553	YT-85403	537	YT-8839	631	YT-99830	624
YT-82801	502	YT-82971	513	YT-83265	191	YT-834599	231	YT-846133	227	YT-84959	554	YT-85451	535	YT-8840	631	YT-99831	626
YT-82802	503	YT-82972	513	YT-83266	191	YT-83460	231	YT-846153	227	YT-84							



REG-707
Branded rack YATO 100 cm /
Regał firmowy YATO 100 cm



REG-777
Hangers set for power tools YATO /
Zestaw zawieszni na elektronarzędzia YATO



REG-779
Hangers set for power tools YATO 18 V /
Zestaw zawieszni na elektronarzędzia YATO 18 V



REG-918
Display for sanding paper YATO in rolls /
Ekspozytor na papier ścierny YATO w rolkach



REG-919
Display for sanding paper YATO in sheets /
Ekspozytor na papier ścierny YATO w arkuszach



REG-908
Standing display for YATO rectifiers /
Ekspozytor stojący na prostowniki YATO



REG-925
Display for YATO work clothes /
Ekspozytor na ubrania robocze YATO



REG-603
Rotary display rack YATO /
Ekspozytor obrotowy YATO



REG-776
Standing triangular display for YATO sets /
Trójstronny ekspozytor stojący na zestaw YATO



REG-763
Standing display for YATO shoes /
Ekspozytor stojący na buty YATO



REG-977
Chrome tube manequin /
Manekin z rury chromowej



REG-764
Standing display for YATO levels /
Ekspozytor stojący na poziomice YATO



REG-708
Branded rack VOREL 100 cm /
Regał firmowy VOREL 100 cm



REG-999
Standing display for window seals VOREL /
Ekspozytor stojący na uszczelki do okien VOREL



REG-954
Display for ropes / Ekspozytor na liny



REG-706
Branded rack STHOR 100 cm /
Regał firmowy STHOR 100 cm



REG-709
Branded rack FLO 100 cm /
Regał firmowy FLO 100 cm



REG-715
Mesh display rack FLO 230 cm /
Regał siatkowy FLO 230 cm



REG-147
Kitchen faucet display rack FALA /
Ekspozytor na baterie kuchenne FALA



REG-146
Bath faucet display rack FALA /
Ekspozytor na baterie łazienkowe FALA



REG-149
Stand for linear drains FALA /
Ekspozytor na odpływy liniowe FALA



REG-808
Display for wave toilet seats FALA /
Ekspozytor na deski toaletowe FALA



REG-992
Display rack for REG-707 for pipe wrenches YATO /
Ekspozytor do REG-707 na klucze do rur YATO



REG-994
Display rack for REG-707 for YATO bits /
Ekspozytor do REG-707 na nasadki YATO



REG-994P
Display rack with the lid for REG-707 for YATO bits /
Ekspozytor z pokrywą do REG-707 na nasadki YATO



REG-998
Display rack for REG-707 for YATO hammers /
Ekspozytor do REG-707 na młotki YATO



REG-993
Display rack for REG-707 for YATO pneumatic tools /
Ekspozytor do REG-707 na narzędzia pneumatyczne YATO



REG-951
Display for carpentry clamps /
Ekspozytor na ścisiki stolarskie



REG-804
Tag for YATO shoes / Zawieszka na buty YATO



REG-991
Display rack for REG-707 for YATO disc saws /
Ekspozytor do REG-707 na piły tarczowe YATO



REG-952
Display for the disc for disc cutters /
Ekspozytor na tarcze do szlifierek kątowych



REG-761
Hook for axes / Wieszak na siekiery



REG-930
Display for YATO buck saws /
Ekspozytor na piły kabłąkowe YATO



REG-868
Hook 30 cm for trowels / Hak 30 cm na kielnie



REG-144
Pendant for wall mounted faucet FALA /
Zawieszka na baterię ścienną FALA



REG-145
Pendant for deck mounted faucet FALA /
Zawieszka na baterię stojącą FALA



REG-909
Display stand for FLO garden tools /
Ekspozytor na narzędzia ogrodowe FLO



REG-911
Pallet display for garden tools /
Ekspozytor paletowy na narzędzia ogrodnicze



REG-799
Display stand VOREL /
Display ekspozycyjny VOREL



REG-902
Standing display for YATO sockets /
Ekspozytor stojący na nasadki YATO



REG-807
Display box for STHOR drill bits /
Ekspozytor skrzynka na wiertła STHOR



REG-604
Wall-stand display rack YATO /
Ekspozytor stojąco-wiszący YATO



REG-605
Waterfall display rack YATO /
Ekspozytor kaskadowy YATO

REG-705
Advertising wobler YATO /
Wobler reklamowy YATO



REG-803
YATO wrench tester /
Tester kluczy YATO



REG-711
Rack shelf for REG-707 YATO /
Półka do REG-707 YATO

Memo

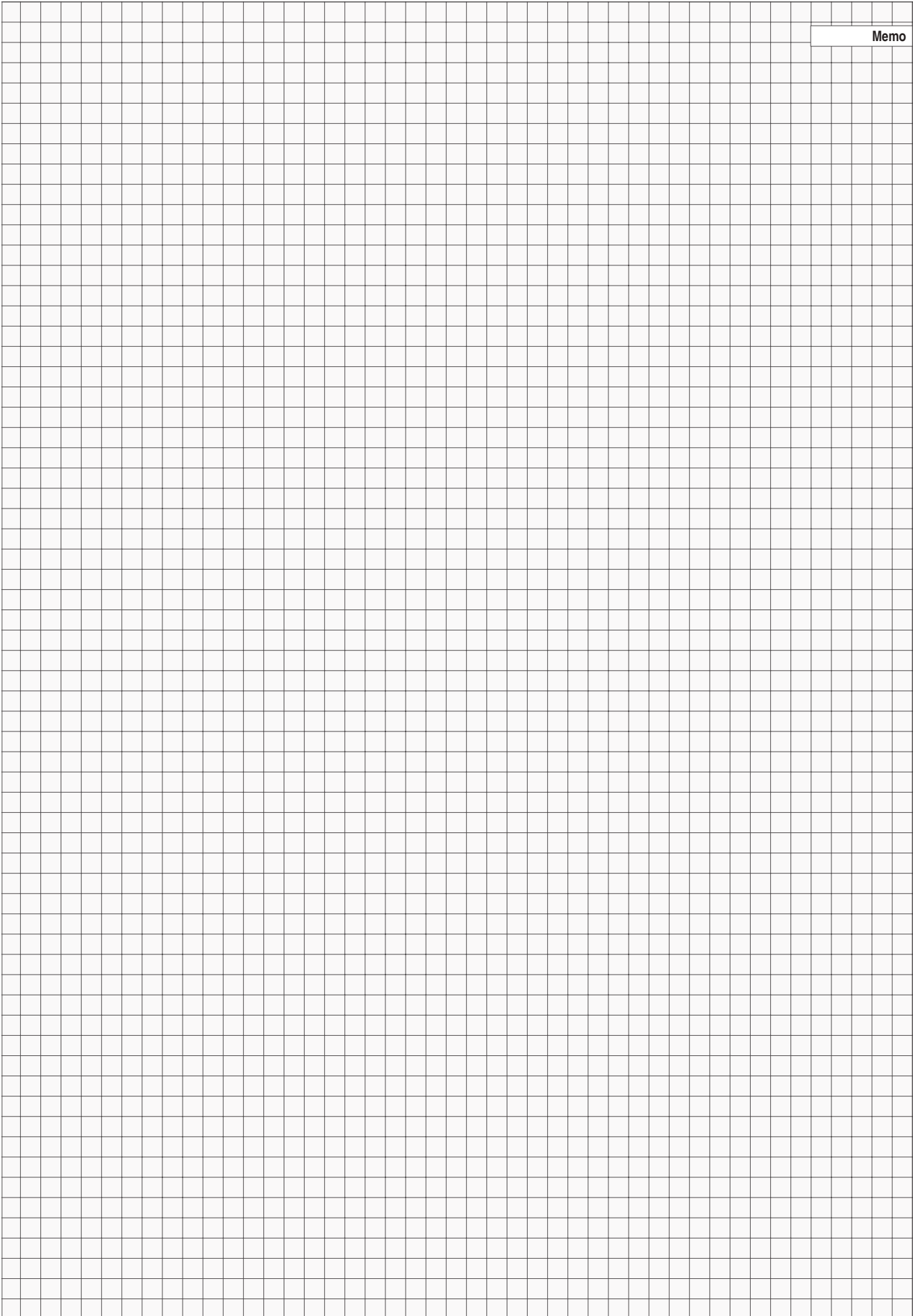

PL

I. TOYA S.A. informuje, iż: 1) niniejszy katalog nie stanowi oferty w rozumieniu prawa cywilnego; 2) prezentowane w niniejszym katalogu artykuły mogą w rzeczywistości odbiegać od wskazanego na zdjęciach wzoru, w szczególności jeżeli chodzi o cechy zewnętrzne, tj. wielkość, kolor, sposób opakowania, liczbę przedmiotów w opakowaniu; 3) nie ponosi odpowiedzialności za drobne różnice w sposobie pakowania czy właściwościach artykułów pozostających bez wpływu na jego przeznaczony cel lub sposób użytkowania; 4) nie ponosi odpowiedzialności wynikającej z jakichkolwiek niedokładności lub nieścisłości, co do informacji zawartych w przedmiotowym katalogu; 5) nie ponosi odpowiedzialności za ewentualną szkodę powstałą w wyniku otrzymania towaru o innych właściwościach niż prezentowany na zdjęciach.

II. Pomimo najlepszych starań poczynionych przez TOYA S.A. nie może ona zagwarantować, iż informacje zawarte w niniejszym katalogu w pełni odpowiadają rzeczywistości.

III. Wszelkie decyzje podjęte na podstawie informacji zawartych w przedmiotowym katalogu podejmowane są na własne ryzyko osoby, która korzysta z tych informacji.

GB

I. TOYA S.A. informs that: 1) the present catalogue does not constitute an offer as construed in the civil law; 2) the goods presented in the present catalogue may in fact differ from the models shown in the pictures, particularly as far as external properties are concerned, namely size, colour, packaging, number of items in the package; 3) the company will not be held responsible for small differences in packaging or properties of the goods, which do not affect the purpose or the exploitation of the tools; 4) the company will not be held responsible for any inaccuracies or imprecision regarding the information presented in the catalogue; 5) the company will not be held responsible for any damage caused by goods whose properties differ from those of the tools presented in the photographs.

II. In spite of all the efforts made by TOYA S.A., the company cannot guarantee the information contained in the present catalogue fully correspond to the reality.

III. Any decisions made on the basis of the information contained in the present catalogue will be made at the risk of the person who makes them using the aforementioned information.

D

I. TOYA S.A. informiert, dass: 1) der vorliegende Katalog kein Angebot im zivilrechtlichen Sinne darstellt; 2) die im vorliegenden Katalog präsentierten Artikel in der Realität von den auf den Musterfotos gezeigten abweichen können, und zwar besonders dann, wenn es um äußere Eigenschaften geht, wie z.B. Größe, Farbe, Art der Verpackung, Anzahl der Gegenstände in der Verpackung; 3) sie keine Verantwortung für geringfügige Unterschiede bei der Verpackungsart oder den Eigenschaften der Artikel übernimmt, die ohne Auswirkungen auf seinen Bestimmungszweck oder die Art der Nutzung bleiben; 4) sie keine Verantwortung für irgendwelche Oberflächlichkeiten und Ungenauigkeiten bzgl. der im Sachkatalog enthaltene Informationen übernimmt; 5) sie keine Verantwortung für eventuelle Schäden, die im Ergebnis des Erhalts der Ware mit anderen als auf den Fotos dargestellten Eigenschaften entstanden sind, übernimmt.

II. Trotz großer Bemühungen seitens TOYA S.A. kann die Firma nicht garantieren, dass die im vorliegenden Katalog enthaltene Informationen voll der Realität entsprechen.

III. Sämtliche Entscheidungen, die auf der Grundlage der im Sachkatalog enthaltene Informationen getroffen wurden, gehen auf das Risiko der Person, die diese Informationen benutzt.

RUS

I. TOYA S.A. заявляет: 1) настоящий каталог не является торговым предложением с точки зрения гражданского законодательства; 2) изделия, представленные в настоящем каталоге, могут отличаться от образцов на снимках, особенно внешним видом, то есть размером, цветом, способом упаковки, количеством предметов в упаковке; 3) производитель не отвечает за мелкие отличия в способе упаковки или свойствах изделий, которые не влияют на предназначение или способ пользования изделиями; 4) производитель не отвечает за мелкие неточности в сведениях из предметного каталога; 5) производитель не отвечает за ущерб, нанесенный вследствие поставки товара, отличающегося параметрами от указанного на снимках.

II. Несмотря на все усилия в данном направлении, компания TOYA S.A. не гарантирует, что информация, метаящаяся в настоящем каталоге, полностью отвечает действительности.

III. Риск, связанный с любыми решениями, принятыми на основании информации из предметного каталога, берут на себя лица, пользующиеся указанной информацией.

CZ

I. TOYA S.A. informuje že: 1) tento katalog nepředstavuje nabídku ve smyslu občanského práva; 2) výrobky prezentované v tomto katalogu se mohou ve skutečnosti lišit od modelů uvedených na obrázcích, zejména co se týká vnějších znaků, tj. velikosti, barvy, způsobu balení, počtu předmětů v balení; 3) nenese odpovědnost za drobné rozdíly ve způsobu balení nebo ve vlastnostech výrobků, které nemají zásadní vliv na jejich určený účel nebo způsob používání; 4) nenese odpovědnost vyplývající z jakýchkoli nepřesností co do informací uvedených v předmětném katalogu; 5) nenese odpovědnost za případné škody vzniklé v důsledku obdržení zboží s jinými vlastnostmi, než je uvedeno na obrázcích.

II. Navzdory mimořádnému úsilí vynaloženému firmou TOYA S.A. tato nemůže garantovat, zda informace uvedené v tomto katalogu zcela odpovídají skutečnosti.

III. Veškerá rozhodnutí přijatá na základě informací uvedených v předmětném katalogu jsou přijímána na vlastní riziko osoby, která tyto informace využívá.

H

I. A TOYA S.A. tájékoztatja, hogy: 1) a jelen katalógus a polgári jog szerint nem kereskedelmi ajánlat; 2) a jelen katalógusban bemutatott árucikkek a valóságban eltérhetnek a képeken látható mintáktól, különösen a külső tulajdonságok, mint a méret, szín, csomagolási mód, a csomagban lévő tárgyak száma tekintetében; 3) nem vállal felelősséget a csomagolás módjában vagy az árucikkek olyan tulajdonságaiban történt változtatásokért, amelyek nem befolyásolják lényeges módon annak rendeltetését vagy a felhasználás módját; 4) nem vállal felelősséget a jelen katalógusban lévő információk pontatlanságáért; 5) nem vállal felelősséget azokért az esetleges károkért, amik az árucikkek a fényképeken látható tulajdonságoktól eltérő tulajdonságokkal történő leszállításából erednek.

II. A TOYA S.A. minden igyekezete ellenére nem tudja garantálni, hogy a jelen katalógusban található információk teljes egészében megfelelnek a valóságnak.

III. A tárgyi katalógusban található információk alapján meghozott bármilyen döntés annak a személynek a rizikója, aki ezeket az információkat felhasználja.

RO

I. TOYA S.A. informează că: 1) prezentul catalog nu constituie ofertă în înțelesul dreptului civil; 2) articolele prezentate în prezentul catalog se pot diferi față de mostrele din fotografiile, în special aspectul exterior, adică mărimea, culoarea, modul de ambalare, cantitatea obiectelor în ambalaj; 3) nu-și asumă răspunderea referitor la mici diferențe la modul de ambalare sau la articolele al căror proprietăți nu au influență referitor la destinația sau modul lor de utilizare; 4) nu-și asumă răspunderea referitor la orice inexactitate sau imprecizie, datorită informațiilor cuprinse în catalogul respectiv; 5) nu-și asumă răspunderea referitor la o eventuală pagubă ca urmare a primirii marfei cu alte proprietăți decât cele prezentate pe fotografiile.

II. Cu toate strădanile TOYA S.A., firma nu poate garanta că, informațiile din prezentul catalog corespund realității.

III. Orice decizie preluată în baza informațiilor cuprinse în catalogul respectiv, sunt preluate pe riscul și răspunderea persoanei care a făcut folos de aceste informații.

E

I. TOYA S.A. comunica lo siguiente: 1) el presente catálogo no constituye una oferta, en el sentido que la noción adquiere en la ley civil; 2) los artículos presentados en el presente catálogo pueden en realidad diferir de los modelos indicados en las fotografías, especialmente en cuanto a sus propiedades externas, es decir el tamaño, el color, el empaque o la cantidad de los objetos en el empaque; 3) la empresa no se hace responsable por pequeñas diferencias en cuanto al empaque o las propiedades de los artículos, siempre y cuando estas diferencias no afectan el propósito o el modo de operación de las herramientas; 4) la empresa no se hace responsable por ninguna imprecisión en cuanto a la información presentada en el presente catálogo; 5) la empresa no se hace responsable por ningún daño que surja del hecho de que los artículos recibidos difieran de los artículos presentados en las fotografías en cuanto a sus propiedades.

II. A pesar de los mejores intentos de parte TOYA S.A. la empresa no puede garantizar que la información presentada en el presente catálogo corresponda completamente a la realidad.

III. Todas las decisiones tomadas en base a la información presentada en el presente son responsabilidad de la persona que recurra a la dicha información.



MANUFACTURER / PRODUCENT

TOYA S.A.
ul. Sołtysowicka 13-15
51-168 Wrocław
Poland
☎ (+48 71) 32 46 200
fax: (+48 71) 32 46 370
sales@yato.pl (domestic)
export@yato.pl (export)
import@yato.pl (import)

ODDZIAŁ WARSZAWSKI
Teren Mapletree Park Nadarzyn
al. Kasztanowa 160
05-831 Młochów k. Warszawy
Poland
☎ (+48 22) 73 82 800
☎ (+48 22) 73 82 828
sales@yato.pl (domestic)
export@yato.pl (export)

TOYA ROMANIA S.A.
Șos. Ștefănești, 8-3A
Ștefăneștii De Jos, Ilfov
România
☎ (+40 031) 710 8692
office@yato.ro

YATO TOOLS (SHANGHAI) CO., LTD.
No. 1, Lane 1300,
East Kangqiao Road
Shanghai, China 201315
☎ (+86 21) 681 829 50
fax: (+86 21) 681 829 51
yato@yato-sh.com

YATO TOOLS (JIAXING) CO., LTD.
No.1033 Huyan Road,
Baibu Town, Haiyan County,
Jiaxing City, Zhejiang Province, China
☎ (+86 21) 681 829 50
yato@yato-sh.com

YOUR TRUSTED SUPPLIER: / TWÓJ ZAUFANY DOSTAWCA:



www.yato.com

GET ACQUAINTED WITH OUR WIDE OFFER:
ZOBACZ NASZĄ BOGATĄ OFERTĘ:

