



PROFESSIONAL
KITCHEN EQUIPMENT



yatogastro.com

YATO



PROFESSIONAL
KITCHEN EQUIPMENT



TABLE OF CONTENTS

Cookware 3-6
Pots and saucepans 3-4
Stainless steel frying pans 5
Aluminium frying pans with teflon coating 6

GN containers 7-8
Stainless steel GN containers 7
Polycarbonate GN containers 8

Containers, jugs, scoops 9-11
Buckets 9
Jugs 9
Cutlery container 9
Food storage containers 10
Kettle paddle 10
Container for bulk products 11
Scoops 11

Kitchen utensils 12-18
Forged steel knives 12
Kitchen scissors 13
Steel for knife sharpening 13
Knife and scissor sharpeners 14
Can opener 14
Chopping boards 15
HACCP chopping boards 15
Rods 16
Narrow spatulas 16
Universal tongs 16
Colander spoons 16-17
Sieves 17
Pizza meshes 18
Condiment dispensers 18

Buffet 19-26
Soup kettle 19
Buffet heaters 20
Water boilers 21
Vacuum flasks 22
Drink dispenser 23
Sauce dispensers 23
Jugs 24
Tiered platter for fruit and biscuits 24
Tongs 24-25
Buffet accessories 25
Banquet trays 26
Waiter trays 26

Bar 27-29
Ice buckets 27
Wine bottle cooler 27
Champagne bucket 27
Cocktail shakers 27
Reception bell 28
Citrus juicer 28
Bartending spoon 28
Bar containers and organisers 28
Glass rimmer 28
Bartender mats 29
Drink dispensers 29
Bottle opener 29
Plugs with dispensers 29

Mechanical processing equipment 30-46
Bone saw 30
Meat mincer with Unger system 31
Sausage stuffers 32
Hamburger presses 32
Meat and cheese slicers 33
Tomato slicers 34
Vegetable shredder 35
Discs for vegetable shredder 36
Potato peelers 37
Handheld blender 37
Bartender's blender 38
Planetary mixers 39-43
Spiral mixers 44-46

Thermal processing equipment 47-62
Induction cookers 47
Grill plates 48
Contact grills 49-50
Gas-fired grills 51-55
Cast iron plate for gas grills 56
Barbecue grill protective covers 56
Deep fryers 57-60
Circulator for sous vide cooking 61
Pancake maker 62
Rice cookers 62

Thermally insulated containers and cabinets for catering 63-65
Food transport containers 63
Thermally insulated catering containers and cabinets 64-65
Thermally insulated beverage dispenser 65

Transport and storage 66-71
Waiter trolleys 66
Service trolleys 67
Transport trolleys 68
Platform trolley 69
Work tables 70
Slatted racks 71
Hanging shelves 71

Vacuum packaging machines 72-76
Vacuum packaging machine 72
Adjustable packaging machines 73-74
Free-standing packaging machines 74
Bags for vacuum packaging machines 75
Industrial vacuum packaging machine 76

Refrigeration 77-94
Cooling and freezing cabinets 77
Cooling and freezing tables 78-82
Freezing cabinet for ice cream cuvettes 82
Glass cooling cabinets and tables 83
Cabinets and tables for bakery 84
Salad cooling tables 85
Pizza cooling tables 86
Accessories for cooling cabinets and tables 87
Cooling extensions 88
Refrigerated display cases for sushi 88
Refrigerated display cases for bottles and accessories 89
Refrigerated display cases 90-94

Sanitation 95-96
Sink with knee switch 95
Water softener 95
Waste shredders 96

Pots and saucepans

DE Töpfe und Stielkasserolen
RU Кастрюли и сотейники
UK Каструлі і сковороди
LT Puodai ir prikaistuviai
LV Katli un kastroļi
CS Hrnce a pánve
SK Hrnca a kastroly
HU Edények és serpenyők
RO Oale și tigăi pentru sos

ES Ollas y sartenes
FR Pots et casseroles
PT Panelas e frigideiras
IT Pentole e tegami
BG Тенджери и касероли
EL Κατσαρόλες και κατσαρόλακια
ZT 不锈钢带盖汤锅

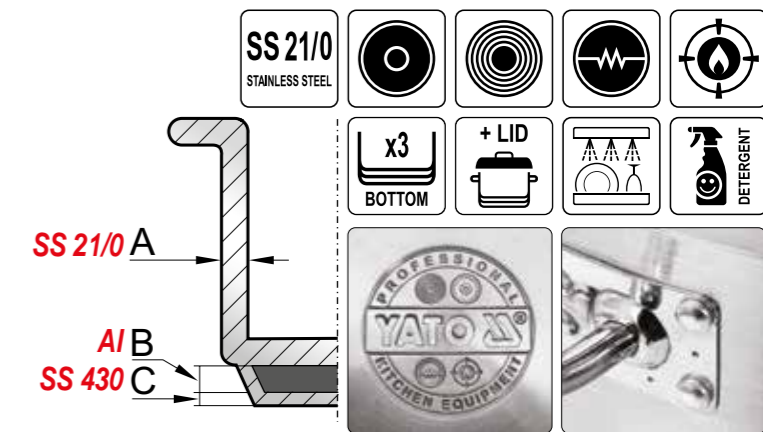

Distribution of heat throughout the bottom

YATO pot

Standard pot



Deep pots with lids

YATO	Ø (cm)	H (cm)	V (l)	A (mm)	B (mm)	C (mm)
YG-00001	16	12	2.4	0.8	4.0	0.8
YG-00002	20	20	6.3	0.8	4.0	0.8
YG-00003	24	20	9.0	0.8	4.0	0.8
YG-00004	28	25	15.4	0.8	4.0	0.8
YG-00005	32	26	20.9	1.0	4.0	0.8
YG-00006	32	32	25.7	1.0	4.0	0.8
YG-00007	36	36	36.6	1.0	4.0	0.8
YG-00008	40	40	50.3	1.0	4.0	1.0
YG-00009	45	45	71.6	1.2	4.0	1.0
YG-00010	50	50	98.2	1.2	4.0	1.0

Medium pots with lids

YATO	Ø (cm)	H (cm)	V (l)	A (mm)	B (mm)	C (mm)
YG-00021	16	9.5	1.9	0.8	4.0	0.8
YG-00022	20	14	4.4	0.8	4.0	0.8
YG-00023	24	16	7.2	0.8	4.0	0.8
YG-00024	28	18	11.1	0.8	4.0	0.8
YG-00025	32	20	16.1	1.0	4.0	0.8
YG-00026	36	22	22.4	1.0	4.0	0.8
YG-00027	40	30	37.7	1.0	4.0	1.0
YG-00028	45	36	57.3	1.2	4.0	1.0
YG-00029	50	32	62.8	1.2	4.0	1.0

Low pots with lids

YATO	Ø (cm)	H (cm)	V (l)	A (mm)	B (mm)	C (mm)
YG-00040	20	10.5	3.3	0.8	4.0	0.8
YG-00041	24	11	5.0	0.8	4.0	0.8
YG-00042	28	13	8.0	0.8	4.0	0.8
YG-00043	32	16	12.9	1.0	4.0	0.8
YG-00044	36	18	18.3	1.0	4.0	0.8
YG-00045	40	25	31.4	1.0	4.0	1.0



Stewing pot with lid

YATO	Ø (cm)	H (cm)	V (l)	A (mm)	B (mm)	C (mm)
YG-00055	36	11	11.2	1.0	4.0	0.8

Pans with lids

YATO	Ø (cm)	H (cm)	V (l)	A (mm)	B (mm)	C (mm)
YG-00060	16	9.5	1.9	0.8	4.0	0.8
YG-00061	20	10.5	3.3	0.8	4.0	0.8
YG-00062	24	11	5	0.8	4.0	0.8
YG-00063	28	13	8	0.8	4.0	0.8

Saucepans

YATO	Ø (cm)	H (cm)	V (l)	A (mm)	B (mm)	C (mm)
YG-00080	20	6.5	2	0.8	4.0	0.8
YG-00081	24	7.5	3.4	0.8	4.0	0.8

Pots with lids

- DE Töpfe mit Deckel
 - RU Горшки с крышками
 - UK Горщики з кришками
 - LT Puodai su dangčiais
 - LV Podi ar vākiem
 - CS Hrnce s víčky
 - SK Hrnce s pokrievkami
 - HU Fedeles edények
 - RO Ghivece cu capace
- ES Ollas con tapa
 - FR Pots avec couvercles
 - PT Potes com tampa
 - IT Pentole con coperchio
 - BG Саксии с капащи
 - EL Γλάστρες με καπάκια
 - ZT 帶蓋花盆

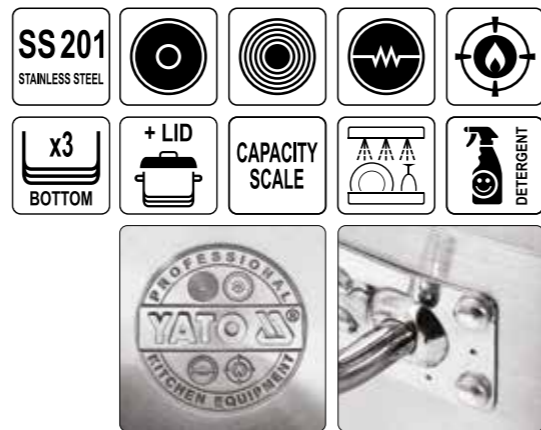

Distribution of heat throughout the bottom

YATO pot

Standard pot

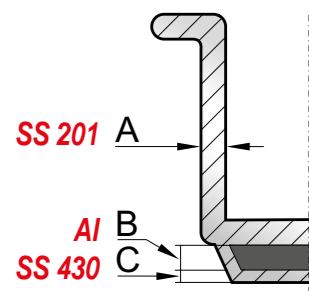
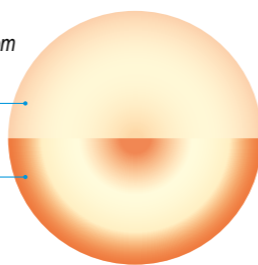

Deep pots with lids

YATO 	∅ (cm)	H (cm)	V (l)	A (mm)	B (mm)	C (mm)
YG-00011	20	20	6	1.0	4.0	0.8
YG-00012	25	25	12	1.0	4.0	0.8
YG-00013	28	28	17	1.0	4.0	0.8
YG-00014	30	30	21	1.0	4.0	0.8
YG-00015	32	32	25	1.0	4.0	0.8
YG-00016	36	36	36	1.0	4.0	0.8
YG-00017	38	38	43	1.0	4.0	0.8
YG-00018	40	40	50	1.0	4.0	0.8
YG-00019	45	45	71	1.2	4.0	1.0
YG-00020	50	50	98	1.2	4.0	1.0

Medium pots with lids

YATO 	∅ (cm)	H (cm)	V (l)	A (mm)	B (mm)	C (mm)
YG-00046	25	18	9	1.0	4.0	0.8
YG-00047	30	20	14	1.0	4.0	0.8
YG-00048	32	22	17	1.0	4.0	0.8
YG-00049	36	24	24	1.0	4.0	0.8
YG-00050	38	24	27	1.0	4.0	0.8
YG-00051	40	26	32	1.0	4.0	0.8
YG-00052	50	30	58	1.2	4.0	1.0

Stainless steel frying pans

- DE Pfannen aus rostfreiem Edelstahl
- RU Стальные сковороды
- UK Каструлі з нержавіючої сталі
- LT Nerūdijančio plieno keptuvės
- LV Nerūsējošā tērauda pannas
- CS Pánve z nerezoucí oceli
- SK Panvice z nehrzdavejúcej ocele
- HU Rozsdamentes acélból készült serpenyők
- RO Tigăi din oțel inoxidabil
- ES Sartenes de acero inoxidable
- FR Casseroles en acier inoxydable
- PT Panelas de aço inoxidável
- IT Padelle in acciaio inossidabile
- BG Тигани от неръждаема стомана
- EL Τηγάνια από ανοξείδωτο ατσάλι
- ZH 不锈钢平底煎锅

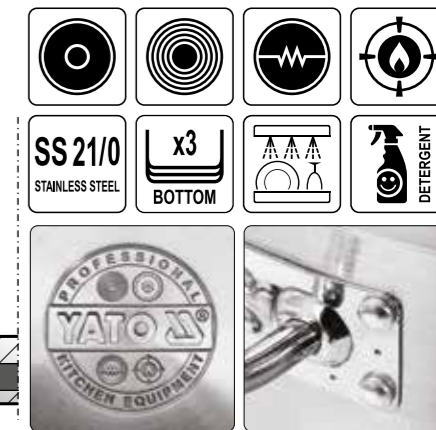

Distribution of heat throughout the bottom

YATO frying pan

Standard frying pan

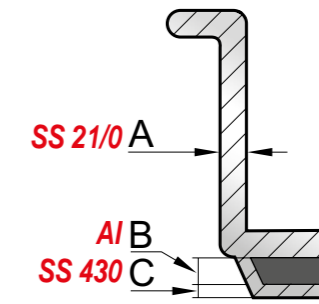

YATO 	∅ (cm)	H (cm)	V (l)	A (mm)	B (mm)	C (mm)
YG-00100	20	4	1.3	0.8	4.0	0.8
YG-00101	24	5	2.3	0.8	4.0	0.8
YG-00102	28	5	3.1	0.8	4.0	0.8



YATO 	∅ (cm)	H (cm)	V (l)	A (mm)	B (mm)	C (mm)
YG-00103	32	5	4	1.0	4.0	0.8
YG-00104	36	6	6.1	1.0	4.0	0.8
YG-00105	40	7	8.8	1.0	4.0	0.8

Aluminium frying pans with Teflon™ Platinum Plus coating

- DE Aluminiumpfannen
- RU Алюминиевые сковороды
- UK Алюмінієві каструлі
- LT Aliuminio keptuvės
- LV Alumīnija pannas
- CS Hliníkové pánve
- SK Hliníkové panvice
- HU Alumínium serpenyők
- RO Tigăi profesionale
- ES Bandejas de aluminio
- FR Plateaux en aluminium
- PT Panelas de alumínio
- IT Padelle in alluminio
- BG Алюминиеви тигани
- EL Τηγάνια αλουμινίου
- ZH 涂层铝制煎锅

The Teflon™ Platinum Plus coating is capable of withstanding even the hardest challenges in gastronomy. It contains microscopic particles of the hardest minerals that form an extraordinarily resilient structure. It is so durable that you can even use metal spatulas while frying without worrying about any significant scratches. Additionally, the body of the pan is made of cast aluminium, which ensures homogeneous and quick heating.

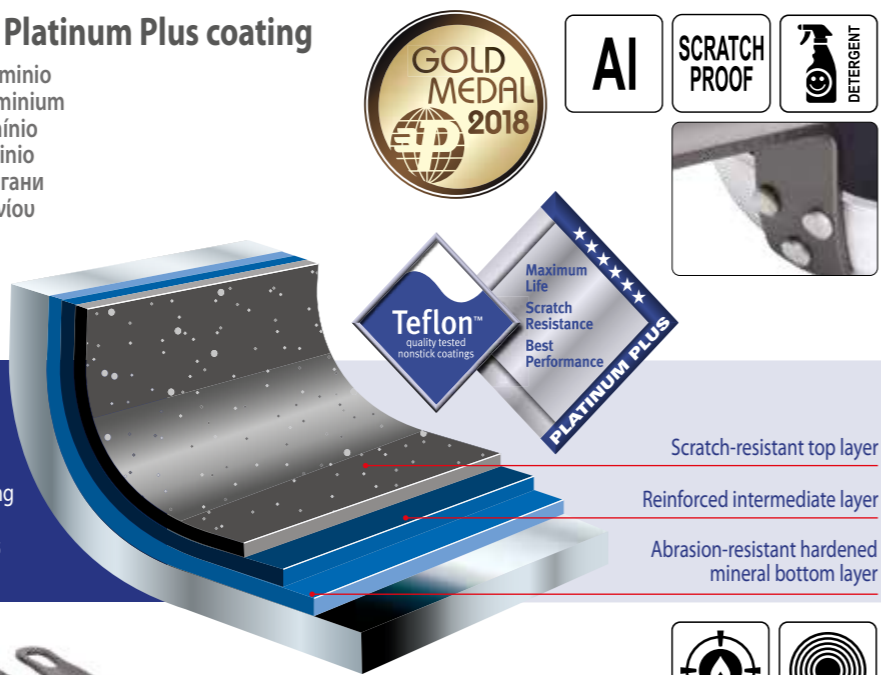

Universal frying pans

YATO 	Ø (cm)*
YG-00131	24
YG-00132	28
YG-00133	32



Frying pans for pancakes

YATO 	Ø (cm)*
YG-00152	26
YG-00153	29



Frying pan for fish

YATO 	Ø (cm)*
YG-00155	29 x 40



Frying pans placed on induction hob

YATO 	Ø (cm)*
YG-00160	24
YG-00161	28

* external diameter



Stainless steel GN containers

- DE Behälter GN aus rostfreiem Edelstahl
- RU Гастроёмкости GN из нержавеющей стали
- UK Контейнери GN з нержавіючої сталі
- LT Nerūdijančio plieno GN indas
- LV Nerūsējošā tērauda GN trauki
- CS Nádobý GN z nerezovací oceli
- SK GN nádoby z nehrdzavejúcej ocele
- HU Rozsdamentes acélból készült GN tartályok
- RO Containere GN din oțel inoxidabil
- ES Contenedores GN de acero inoxidable
- FR Récipients GN en acier inoxydable
- PT Recipientes GN em aço inoxidável
- IT Contenitore GN di acciaio inossidabile
- BG GN контейнери от неръждаема стомана
- EL Δοχεία GN από ανοξείδωτο ασάλι
- ZH 不锈钢份数盘

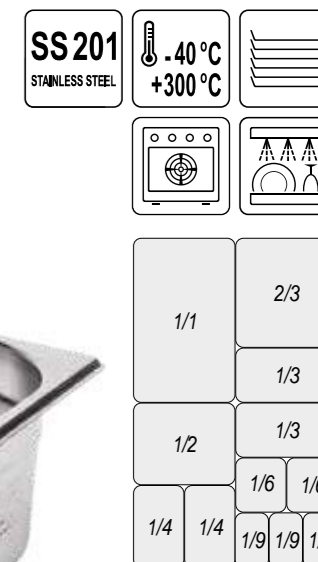

GN 1/1 – 530 x 325 mm

YATO 	H (mm)	V (l)
YG-00250	20	3.0
YG-00251	40	6.0
YG-00252	65	8.5
YG-00253	100	13.5
YG-00254	150	20.5
YG-00255	200	26.0

GN 2/3 – 354 x 325 mm

YATO 	H (mm)	V (l)
YG-00302	65	6.5
YG-00303	100	9.0
YG-00304	150	13.0

GN 1/2 – 325 x 265 mm

YATO 	H (mm)	V (l)
YG-00260	20	2.0
YG-00261	40	4.0
YG-00262	65	4.5
YG-00263	100	7.0
YG-00264	150	10.0
YG-00265	200	12.5

GN 1/3 – 325 x 176 mm

YATO 	H (mm)	V (l)
YG-00270	20	0.8
YG-00271	40	1.5
YG-00272	65	2.5
YG-00273	100	4.0
YG-00274	150	6.0



GN 1/4 – 265 x 162 mm

YATO 	H (mm)	V (l)
YG-00282	65	1.8
YG-00283	100	3.0
YG-00284	150	4.5



GN 1/6 – 176 x 162 mm

YATO 	H (mm)	V (l)
YG-00290	65	1.0
YG-00291	100	1.7
YG-00292	150	2.5
YG-00293	200	3.4



GN 1/9 – 176 x 108 mm

YATO 	H (mm)	V (l)
YG-00295	65	0.6
YG-00296	100	1.0



Container size designation in the corner



GN 1/1 – 530 x 325 mm perforated

YATO 	H (mm)	V (l)
YG-00340	20	3.0
YG-00341	40	6.0
YG-00342	65	8.5
YG-00343	100	13.5
YG-00344	150	20.5
YG-00345	200	26.0



GN 2/3 – 354 x 325 mm perforated

YATO 	H (mm)	V (l)
YG-00360	65	6.5
YG-00361	100	9.0



GN 1/2 – 325 x 265 mm perforated

YATO 	H (mm)	V (l)
YG-00355	65	4.5
YG-00356	100	7.0
YG-00357	150	10.0

Stainless steel lids for GN containers

YATO 	FOR:
YG-00370	GN 1/1
YG-00371	GN 1/2
YG-00372	GN 1/3
YG-00373	GN 1/4
YG-00374	GN 1/6
YG-00375	GN 1/9
YG-00377	GN 2/3

Polycarbonate GN containers

DE Behälter GN aus Polycarbonat
RU Гастроёмкости GN из поликарбоната
UK Контейнери GN з полікарбонату
LT Polikarbonato GN indas
LV Poliābonāta GN trauki
CS Nádoby GN z polykarbonátu
SK GN nádoby z polykarbonátu
HU Polikarbonát GN tartályok
RO Containere GN din policarbonat
ES Contenedores GN de policarbonato
FR Récipients GN en polycarbonate
PT Recipientes GN em policarbonato
IT Contenitore GN in policarbonato
BG GN контейнери от поликарбонат
EL Δοχεία GN από πολυανθρακικό
ZH 聚碳酸酯份数盆

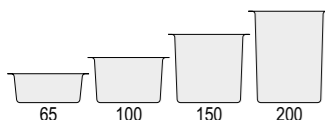
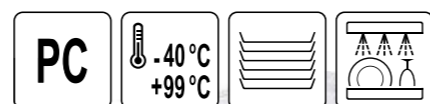

GN 1/1 – 530 x 325 mm

YATO	H (mm)	V (l)
YG-00390	65	8.5
YG-00391	100	13.0
YG-00392	150	19.5
YG-00393	200	25.6



GN 1/2 – 325 x 265 mm

YATO	H (mm)	V (l)
YG-00400	65	3.9
YG-00401	100	5.9
YG-00402	150	8.9
YG-00403	200	11.7



GN 1/3 – 325 x 176 mm

YATO	H (mm)	V (l)
YG-00410	65	2.4
YG-00411	100	3.6
YG-00412	150	5.3
YG-00413	200	6.9

Polycarbonate lids for GN containers

YATO	FOR:
YG-00434	GN 1/1
YG-00435	GN 1/2
YG-00436	GN 1/3
YG-00437	GN 1/4
YG-00438	GN 1/6
YG-00439	GN 1/9

Polycarbonate drain shelves for GN containers

YATO	FOR:
YG-00460	GN 1/1
YG-00461	GN 1/2
YG-00462	GN 1/3
YG-00463	GN 1/4
YG-00464	GN 1/6

Buckets

DE Eimer
RU Ведро
UK Відра
LT Kibirai
LV Kausi
CS Kbelíky
SK Vedrá
HU Vödörök
RO Cupe
ES Cubos
FR Seaux
PT Baldes
IT Secchi
BG Кофи
EL Κουβάδες
ZH 水桶



YATO	V (l)	Ø (cm)	H (cm)
YG-00650	12	25/24	27
YG-00651	16	30/25	30
YG-00652	28	35/30	35

Scale jugs

DE Messbecher
RU Мерные кувшины
UK Глечики з мірками
LT Asočiai su matavimo skale
LV Mērkrūzes
CS Džbány s měrkou
SK Džbany s mierkou
HU Mérókanna

RO Căni de măsură
ES Jarra medidora
FR Cruche à mesurer
PT Jarros de medição
IT Brocca con misurino
BG Кани с деления
EL Κανάτα με μέτρο
ZH 量壶



YATO	V (l)	Ø (mm)	H (mm)
YG-07282	0.5	90	135
YG-07284	1	115	165
YG-07286	2	150	205
YG-07287	3	170	230
YG-07288	5	195	270



Container for cutlery

DE Besteckbehälter
RU Емкость для столовых приборов
UK Контейнер для столових приборів
LT Stalo įrankių padėklas
LV Galda piederumu trauki
CS Nádoby na příbory
SK Nádoby na príbor
HU Evőeszköz tartó
RO Organizator pentru tacâmuri

ES Cubertero
FR Range-couverts
PT Recipiente para talheres
IT Contenitore per posate
BG Контейнер за прибори
EL Δοχείο για μαχαιροπίρουνα
ZH 4格餐具收納盒

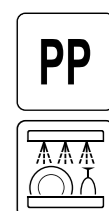

YATO	(mm)
YG-02665	520 x 290 x 95



Food storage containers

DE Behälter zur Aufbewahrung von Lebensmitteln
 RU Контейнеры для хранения пищевых продуктов
 UK Контейнери для зберігання продуктів харчування
 LT Maisto saugojimo indai
 LV Pārtikas uzglabāšanas trauki
 CS Nádoby k uchovávání potravin
 SK Nádoby na uschovávanie potravín
 HU Ételtároló tartályok
 RO Containere pentru depozitarea alimentelor
 ES Contenedores para el almacenamiento de alimentos
 FR Récipients pour le stockage des aliments
 PT Recipientes para armazenamento de alimentos
 IT Contenitore per la conservazione di alimenti
 BG Контейнери за съхранение на храни
 EL Δοχεία αποθήκευσης τροφίμων
 ZH PP圆形食品储物桶



-15°C
+80°C

Round containers

YATO	V (l)	Ø (mm)	H (mm)
YG-00510	1	128	120
YG-00511	2	183	110
YG-00512	4	183	210
YG-00513	6	222	200
YG-00514	7.5	222	270
YG-00515	10	310	210
YG-00516	15	310	300
YG-00517	20	310	370

PP



Covers for round containers

YATO	Ø (mm)	FOR:
YG-00518	132	YG-00510
YG-00519	187	YG-00511, YG-00512
YG-00520	226	YG-00513, YG-00514
YG-00521	316	YG-00515, YG-00516, YG-00517

PE

Square containers

YATO	V (l)	(mm)	H (mm)
YG-00522	6	222 x 222	185
YG-00524	22	280 x 280	400

PC



-40°C
+99°C

Cover for square containers

YATO	(mm)	FOR:
YG-00526	293 x 293	YG-00524

PE

Kettle paddle

DE Rührpaddel für Kessel
 RU Мешалка для котла
 UK Мішалка для котла
 LT Maišytuvės katilui
 LV Maisītājs katlam
 CS Míchadlo do kotle
 SK Miešadlo pre kotol
 HU Keverő lapát
 RO Paletă pentru amestecat
 ES Agitador de caldera
 FR Agitateur de chaudière cuisine
 PT Agitador para caldeiras
 IT Spatola lunga
 BG Бъркалка за тенджера
 EL Αναδευτήρας λέβητα
 ZH 不锈钢打蛋器

SS 18/8
STAINLESS STEEL

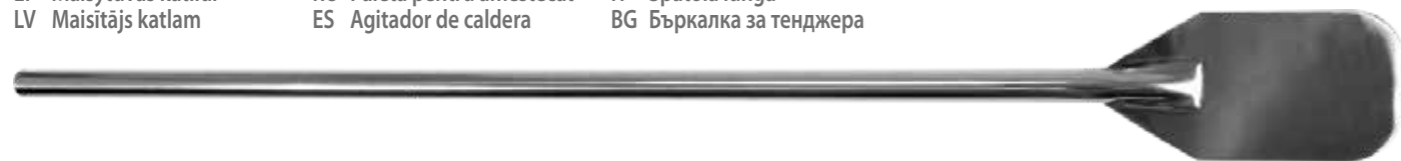

YATO	L (mm)
YG-02520	1220

Container for bulk products

DE Behälter für lose Produkte
 RU Контейнер для сыпучих продуктов
 UK Контейнер для сипучих продуктів
 LT Palaidų produktų indas
 LV Trauks beramiem produktiem
 CS Nádoby na sypké materiály
 SK Nádoby na sypké produkty
 HU Tartály szórt termékekhez
 RO Container pentru produse vrac
 ES Contenedor para productos a granel
 FR Récipient pour produits en vrac
 PT Recipiente para produtos soltos
 IT Contenitore per prodotti sfusi
 BG Контейнер за насипни продукти
 EL Δοχείο για χύμα προϊόντα
 ZH 食物配料儲存车



81L
CAPACITY

PP/PC

77kg 63kg
SUGAR FLOUR
CAPACITY

360°
2x



YATO	V (l)	(mm)
YG-09109	81	760 x 330 x 740

Polycarbonate scoops

DE Schaufeln aus Polycarbonat
 RU Совки из поликарбоната
 UK Совки з полікарбонату
 LT Polikarbonato semtuvėlis šiukšlėms
 LV Polikarbonāta lāpstiņas
 CS Naběračky z polykarbonátu
 SK Lopatky z polykarbonátu
 HU Polikarbonát lapát
 RO Scafe din policarbonat
 ES Paletas de policarbonato
 FR Spatule en polycarbonate
 PT Colheres de policarbonato
 IT Palette in policarbonato
 BG Лопатки от поликарбонат
 EL Πολυκαρβονικά φαράσια
 ZH PC冰铲

PC
-40°C
+99°C

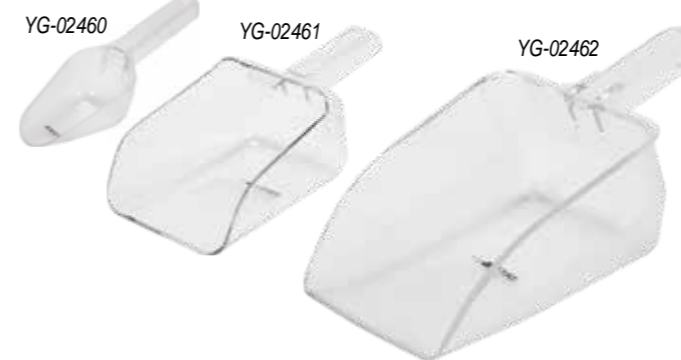

YATO	V (l)	(mm)
YG-02460	0.18	220 x 185
YG-02461	0.95	280 x 210
YG-02462	1.9	280 x 400

Aluminium scoops

DE Aluminiumschaufeln
 RU Алюминиевые совки
 UK Алюмінієві совки
 LT Aliuminio semtuvėlis šiukšlėms
 LV Alumīnija lāpstiņas
 CS Hliníkové naběračky
 SK Hliníkové lopatky
 HU Alumínium lapát
 RO Scafe din aluminiu
 ES Paletas de aluminio
 FR Spatule en aluminium
 PT Colheres de alumínio
 IT Palette in alluminio
 BG Алюминиеви лопатки
 EL Φαράσια αλουμινίου
 ZH 铝冰铲

Al



YATO	V (l)	L (mm)
YG-02450	0.15	185
YG-02451	0.35	220
YG-02452	0.7	270
YG-02453	1.7	380

Forged steel knives

- | | | |
|-----------------------------|-------------------------------|--------------------------------------|
| DE Messer aus Schmiedestahl | SK Nož z kovanej ocele | IT Coltelli in acciaio forgiato |
| RU Ножи из кованой стали | HU Kovácsolt acél kés | BG Ножове от кована стомана |
| UK Ножи з кованої сталі | RO Cuțite din oțel forjat | EL Μαχαίρια από σφυρηλατημένο χάλυβα |
| LT Kaltinio plieno peiliai | ES Cuchillos de acero forjado | ZH 西厨刀 |
| LV Kaltā tērauda naži | FR Couteaux en acier forgé | |
| CS Nože z kované oceli | PT Facas de aço forjado | |



Chef's knives

YATO	L (mm)
YG-02230	205 / 340
YG-02231	255 / 395



Butcher knife

YATO	L (mm)
YG-02229	205 / 340



Ham knife

YATO	L (mm)
YG-02232	290 / 425



Boning knife

YATO	L (mm)
YG-02224	160 / 290



Bread knife

YATO	L (mm)
YG-02223	205 / 340



Tomato knife

YATO	L (mm)
YG-02227	140 / 245



Paring knives

YATO	L (mm)
YG-02225	90 / 195
YG-02226	90 / 196



Meat fork

YATO	L (mm)
YG-02216	180 / 310

Kitchen scissors

- | | | | |
|------------------------|----------------------|------------------------------|----------------------|
| DE Küchenschere | LV Virtuves naži | RO Foarfeci pentru bucătărie | IT Forbici da cucina |
| RU Кухонные ножницы | CS Kuchyňské nůžky | ES Tijeras de cocina | BG Кухненски ножници |
| UK Кухонні ножці | SK Kuchynské nožnice | FR Ciseaux de cuisine | EL Ψαλίδια κουζίνας |
| LT Virtuviniai peiliai | HU Konyhai ollók | PT Tesouras de cozinha | ZH 厨房剪刀 |

SS2CR13

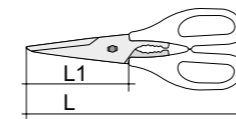

Blade thickness: 1.8 mm

YATO	L (mm)	L1 (mm)
YG-02365	210	80



Blade thickness: 3 mm

YATO	L (mm)	L1 (mm)
YG-02366	210	70

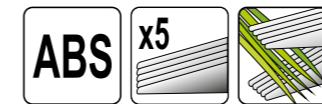
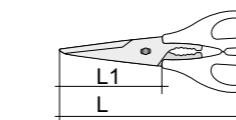

Blade thickness: 1.2 mm

YATO	L (mm)	L1 (mm)
YG-02368	200	80



Steel for knife sharpening

- | | | |
|--------------------------------|-----------------------------------|----------------------------------|
| DE Stahlmesserschärfer | SK Ocelová brúška na nože | IT Affilcoltelli in acciaio |
| RU Точилка для ножей из стали | HU Acél késélező | BG Точилка за ножове |
| UK Stahlmesserschärfer | RO Ascuțitor pentru oțel | EL Ξύστρα για μαχαίρι από χάλυβα |
| LT Plieninis peilių gaštuvuvas | ES Afilador de cuchillos de acero | ZH 钢磨刀器 |
| LV Tērauda nažu asinātājs | FR Aiguiseur de couteaux en acier | |
| CS Ořezávkó ocelového nože | PT Afiador de facas de aço | |

SS
STAINLESS STEEL

PP

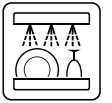

YATO	L (mm)
YG-02214	200 / 320

Knife and scissor sharpeners

- | | | | |
|--|--|---|---------------------------------------|
| DE Scheren- und Messerschärfer | CS Ostrůtko na nože a nůžky | ES Afiladoras de cuchillos y tijeras | EL Ακονιστήρια μαχαιριών και ψαλιδιών |
| RU Точилки для ножей и ножиц | SK Nástroje na ostrenie nožov a nožnic | FR Aiguilleurs à couteaux et ciseaux | |
| UK Пристрій для заточування ножів і ножиць | HU Kés- és ollóélező | PT Afiadores de facas e tesouras | ZH 磨刀器 |
| LT Peilių ir žirklių galastuvai | RO Dispozitive pentru ascuțit cuțite și foarfeci | IT Affilatrice per coltelli e forbici | |
| LV Nažu un šķēru asināmie | | BG Точила за заточване на ножове и ножици | |

3-function sharpener for steel and ceramic knives



YATO
YG-02351

EASY CLEAN

- 3 in 1**
- CERAMIC BLADE
- DIAMOND BLADE
- TUNGSTEN STEEL BLADE
- FOR CERAMIC KNIVES
- FOR METAL KNIVES
- NON-SLIP BASE

2-function sharpener for ceramic and steel knives



YATO
YG-02353

- 2 in 1**
- CERAMIC BLADE
- DIAMOND BLADE
- FOR CERAMIC KNIVES
- FOR METAL KNIVES
- NON-SLIP BASE

4-function sharpener for scissors, smooth metal knives and ceramic knives



YATO
YG-02352



NON-SLIP BASE

- 4 in 1**
- DIAMOND BLADE
- CERAMIC BLADE
- TUNGSTEN STEEL BLADE
- FOR CERAMIC KNIVES
- FOR METAL KNIVES
- FOR SCISSORS

Compact sharpener for smooth metal knives



YATO
YG-02354



NON-SLIP BASE

- 2 in 1**
- CERAMIC BLADE
- FOR METAL KNIVES
- TUNGSTEN STEEL BLADE

Can opener

- | | |
|--------------------------|---------------------------|
| DE Dosenöffner | RU Консервный нож |
| UK Відкривачка для банок | LT Skardinių atidarytuvas |
| LV Bundžu attaisāmais | CS Otvírák na konzervy |
| SK Otvárač na konzervy | HU Konzervnyitó |
| RO Desfăcător conserve | ES Abrelatas |
| FR Ouvre-boîte | PT Abridor de latas |
| IT Apriscatole | BG Отварачка за консерви |
| EL Ανοιχτήρι κονσερβών | ZH 开罐器 |



YATO	∅ (mm)
YG-02430	355



∅ max
355mm
CAN

H max
310mm
CAN

Chopping boards

- | | | | |
|-----------------------|----------------------|------------------------|--------------------|
| DE Schneidebretter | LV Griešanas dēļi | RO Tocătoare | IT Tagliere |
| RU Разделочные доски | CS Krájecí deska | ES Tablas para cortar | BG Дъски за рязане |
| UK Обробні дошки | SK Dosky na krájanie | FR Planches à découper | EL Σανίδες κοπής |
| LT Pjaustymo lentelės | HU Vágódeszkák | PT Tábuas de cortar | ZH 砧板 |



Chopping boards with a handle



YATO	(mm)
YG-02150	250 x 150 x 10
YG-02153	300 x 220 x 10

Chopping boards compliant with HACCP colour coding

YATO	(mm)	COLOUR
YG-02170	450 x 300 x 13	●
YG-02171	450 x 300 x 13	●
YG-02172	450 x 300 x 13	●
YG-02173	450 x 300 x 13	●
YG-02174	450 x 300 x 13	○
YG-02175	450 x 300 x 13	●
YG-02180	600 x 400 x 20	●
YG-02181	600 x 400 x 20	●
YG-02182	600 x 400 x 20	●
YG-02183	600 x 400 x 20	●
YG-02184	600 x 400 x 20	○
YG-02185	600 x 400 x 20	●

Chopping boards with rubber feet

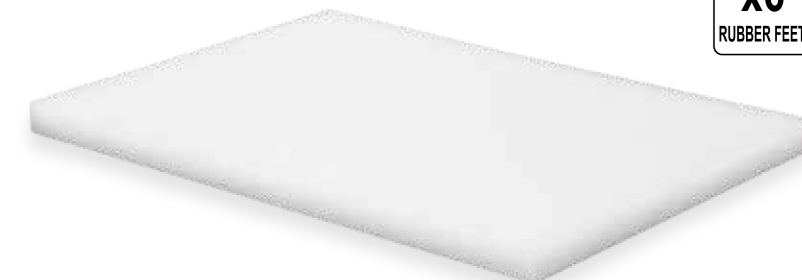

x6
RUBBER FEET

YATO	(mm)
YG-02160	350 x 250 x 20
YG-02163	440 x 290 x 20
YG-02166	500 x 340 x 20
YG-02168	600 x 390 x 20

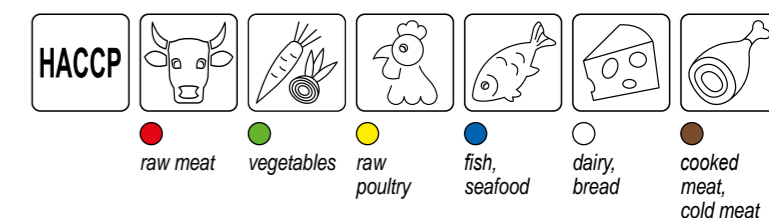

Chopping board scraper

- | | |
|--|-------------------------------------|
| DE Schneidebrett-Schaber | ES Rascador para tablas de corte |
| RU Рубанок для очистки разделочных досок | FR Racloir pour planches à découper |
| UK Скребок для обробних дощок | PT Raspador para tábuas de cortar |
| LT Pjaustymo lentelių grandiklis | IT Raschietto per tagliere |
| LV Skrāpis griešanas dēļiem | BG Ренде за дъски за рязане |
| CS Škrabka na krájecí desku | EL Ξέστρο για σανίδες κοπής |
| SK Škrabka pre dosky na krájanie | ZH 砧板刮 |
| HU Vágódeszka kaparó | |
| RO Răzuitoare pentru tocătoare | |

FOR:
PE



YATO	(mm)
YG-02188	220 x 100 x 50

Rods

- | | | |
|------------------------|------------------------|---------------------|
| DE Schneebesens | SK Mieltičky | IT Frusta da cucina |
| RU Шампуры | HU Habverők | BG Тел за разбиване |
| UK Пізки | RO Teluri | EL Αβγοδάρτες |
| LT Rankiniai plaktuvai | ES Varillas para batir | ZH 棒 |
| LV Putojamās slotiņas | FR Fouets | |
| CS Metly | PT Batedores | |



SS 18/8
STAINLESS STEEL

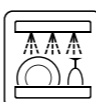

YATO	L (mm)
YG-02510	300
YG-02511	400
YG-02512	500
YG-02513	600

Narrow spatulas

- | | |
|--------------------------------|----------------------------------|
| DE Schmale Tortenstreichspatel | ES Espátulas de cocina estrechas |
| RU Узкие шпатели | FR Spatules de cuisine étroites |
| UK Вузькі шпатели | PT Espátulas estreitas |
| LT Šiaura mentelė | IT Spatole strette |
| LV Šauras lāpstiņas | BG Тесни шпатули |
| CS Úzké špachtle | EL Στενές σπαθίδες |
| SK Špachtle úzke | ZH 不锈钢铲 |
| HU Keskeny spatulák | |
| RO Spatulă înguste | |



SS
STAINLESS STEEL



Narrow straight spatulas

YATO	(mm)
YG-02408	120 / 225
YG-02409	205 / 335
YG-02410	255 / 385
YG-02411	310 / 440
YG-02412	355 / 485

Narrow angled spatulas

YATO	(mm)
YG-02415	255 / 385
YG-02416	300 / 430

Universal tongs

- | |
|--------------------------|
| DE Universalzangen |
| RU Универсальные щипцы |
| UK Універсальні щипці |
| LT Universaliūs žnyplės |
| LV Universālas stangas |
| CS Univerzální kleště |
| SK Univerzálna kliešte |
| HU Univerzális fogók |
| RO Clești universali |
| ES Alicates multiusos |
| FR Pince multi-usages |
| PT Alicates universais |
| IT Pinze universali |
| BG Универсални щипки |
| EL Λαβίδα γενικής χρήσης |
| ZH 不锈钢夹 |



SS 18/8
STAINLESS STEEL



YATO	L (mm)
YG-02750	240
YG-02751	300
YG-02752	400

Colander spoons

- | |
|-----------------------|
| DE Schaumlöffel |
| RU Шумовки |
| UK Друшляки |
| LT Kiaurasamčiai |
| LV Putu karotes |
| CS Dírkované lžíce |
| SK Zberačky |
| HU Csepegtető kanálok |
| RO Spumiere |
| ES Cucharas coladoras |
| FR Araignées |
| PT Escumadeiras |
| IT Schiumarola |
| BG Решетъчни лъжици |
| EL Τρυπητές κουτάλες |
| ZH 不锈钢漏勺 |



SS 18/8
STAINLESS STEEL



YATO	Ø (mm)	L (mm)
YG-02593	120	475
YG-02595	140	570
YG-02598	160	580



Colander spoons and sieves

- | | |
|-----------------------------------|-------------------------------------|
| DE Schaumlöffel und Siebe | PT Escumadeiras e peneiras |
| RU Шумовки и сита | IT Schiumarola e setaccio |
| UK Друшляки і сита | BG Решетъчни лъжици и цедки |
| LT Kiaurasamčiai ir sieteliai | EL Τρυπητές κουτάλες και σουρωτήρια |
| LV Putu karotes un sieti | ZH 漏勺和筛子 |
| CS Dírkované lžíce a síta | |
| SK Zberačky a sitká | |
| HU Csepegtető kanálok és sziták | |
| RO Strecurătoare și site | |
| ES Cucharas coladoras y coladores | |
| FR Araignées et passoires | |

Colander spoons with a rim

YATO	Ø (mm)	L (mm)
YG-00600	220	600
YG-00601	260	730



SS 18/8
STAINLESS STEEL

HANGABLE

FINE MESH



Mesh density: 2 x 2 mm

LARGE MESH

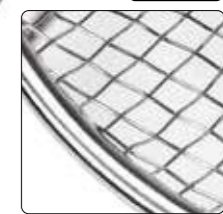

Mesh density: 5 x 5 mm

Colander spoons

YATO	Ø (mm)	L (mm)
YG-00602	155	470
YG-00603	200	510



FINE MESH

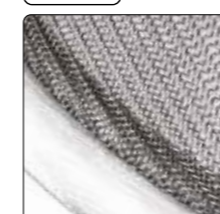

Mesh density: 0.5 x 0.5 mm

Thick mesh chinois

YATO	Ø (mm)	L (mm)
YG-00605	120	310
YG-00606	160	350

Sieves for sifting

YATO	Ø (mm)	H (mm)
YG-00615	220	60
YG-00617	280	70



FINE MESH

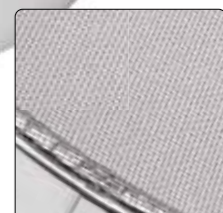

Mesh density: 1 x 1 mm



Pizza meshes

- DE Pizza-Gitter
- RU Сетки для пиццы
- UK Сітки для піци
- LT Picų tinklai
- LV Sieti picai
- CS Sítky na pizzu
- SK Siete na pizzu
- HU Pizzarácsok
- RO Tăvi sită pentru pizza
- ES Rejillas para la pizza
- FR Tamis à pizza
- PT Telas de pizza
- IT Rete per pizza
- BG Решетки за пица
- EL Κόσκινα για pizza
- ZH 披萨网筛



AI

Mesh density: 4 x 5 mm



YATO	Ø (mm)	Ø INSIDE (mm)
YG-02030	230	210
YG-02031	280	260
YG-02032	300	280
YG-02033	330	310
YG-02034	350	330
YG-02035	380	360
YG-02036	400	380
YG-02037	450	430
YG-02038	500	480

Condiment dispensers

- DE Spender für kalte Soßen
- RU Диспенсеры для холодных соусов
- UK Диспенсери для холодних соусів
- LT Šaltų padažų dalytuvai
- LV Austo mērču dispenseri
- CS Dávkořač na studené omáčky
- SK Dispenzér na studené omáčky
- HU Hideg szósz adagoló
- RO Dispenser pentru sosuri
- ES Dispensadores de salsa fría
- FR Distributeurs de sauce froide
- PT Dispensadores de molhos frios
- IT Dispenser per salse fredde
- BG Диспенсьри за студени сосове
- EL Δοχεία για κρύες σάλτσες
- ZH 调料瓶



PE



YATO	COLOUR	V (l)	H (mm)	Ø (mm)
YG-00550	●	0.35	200	60
YG-00551	●	0.35	200	60
YG-00552	○	0.35	200	60
YG-00553	●	0.7	260	65
YG-00554	●	0.7	260	65
YG-00555	○	0.7	260	65

Soup kettle

- DE Suppenkessel
- RU Мармит электрический для супа
- UK Казанок для супів
- LT Sriubos marmitas
- LV Katls zupām
- CS Kotlík na polévku
- SK Kotlíky na polievky
- HU Levesmelegítő
- RO Supieră electrică
- ES Olla de sopa
- FR Marmite à soupe
- PT Chaleira de sopa
- IT Bollitore per zuppa
- BG Супник
- EL Καζάνι για σούπες
- ZH 汤壶

400W 9L SS 304 BARELL 35-85 °C x4 PLASTIC FEET

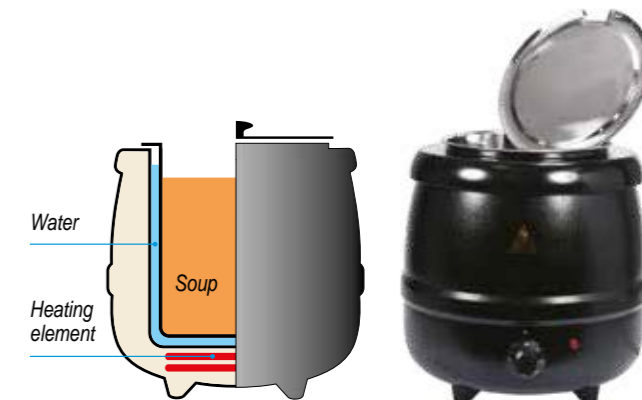

YATO	V (l)	(mm)	(W)
YG-04250	9	340 x 340 x 370	400

Buffet heaters

DE Speisenwärmer
RU Мармиты буфетные
UK Буфетні підігрівачі
LT Maisto šildytuvai
LV Bufešu sildītāji
CS Bufetové ohřivače
SK Bufetové ohrievače
HU Büfé melegítők
RO Chafing dish
ES Calentadores de comida para buffet
FR Buffets chauffants

PT Aquecedores para buffets
IT Scaldavivande per catering
BG Настолни бен марита
EL Θερμάστρα μπουφέ
ZH 自助餐炉

FOR:
GN 1/1
max 65 mm

90°
COVER
OPEN ANGLE

x2
HANDLES

SEE ALSO
tongs and spoons



p. 25

SS 201
STAINLESS STEEL

HEAT SOURCE:
FUEL / HEATER



x2
HANDLES



Roll-top heater GN 1/1

YATO	V (l)	(mm)
YG-04120	9	600 x 350 x 430

FOR:
GN 1/1
max 65 mm

180°
COVER
OPEN ANGLE



Roll-top heater GN 1/1

YATO	V (l)	(mm)
YG-04140	9	640 x 420 x 440



Heater with kettles

YATO	V (l)	(mm)
YG-04125	2 x 4.5	600 x 350 x 370

FOR:
GN
ø 350 mm

180°
COVER
OPEN ANGLE



Round roll-top heater

YATO	V (l)	(mm)
YG-04145	6	470 x 450

Water boilers

DE Wasserkocher
RU Электрокипятильник воды
UK Термопоти
LT Vandens viryklės
LV Tējannas
CS Vařiče na vodu
SK Ohrievače na varenie vody
HU Vízmelegítők
RO Fierbător
ES Hervidores de agua
FR Bouilloires d'eau
PT Dispensadores de água
IT Distributori a termos per acqua
BG Машини за чай
EL Βραστήρας νερού
ZH 开水桶

YATO	V (l)	(W)
YG-04301	8.8	1000
YG-04310	10.0	1650
YG-04315	15.0	1800
YG-04318	16.0	2600
YG-04324	22.0	3000

Collection tray

DE Abtropftablett
RU Поддон для сбора капель
UK Піддон для стоків
LT Nulašėjimo dėklas
LV Notekraplāte
CS Odtékací táč
SK Odkvapkováacia miska

HU Csepegtető tábla
RO Tavă colectoare
ES Bandeja con rejilla para el goteo
FR Plateau d'égouttement
PT Bandeja de gotejamento

IT Vaschetta raccogli-gocce
BG Тавичка за оттичане на вода
EL Δοχείο συλλογής
ZH 滴水盘



YATO	FOR:
YG-04325	YG-04301, YG-04310, YG-04315, YG-04318, YG-04324

Water boilers

DE Wasserkocher
RU Электрокипятильник воды
UK Термопоти
LT Vandens viryklės
LV Tējannas
CS Vařiče na vodu
SK Ohrievače na varenie vody
HU Vízmelegítők
RO Fierbător
ES Hervidores de agua
FR Bouilloires d'eau
PT Dispensadores de água
IT Distributori a termos per acqua
BG Машини за чай
EL Βραστήρας νερού
ZH 开水桶

YATO	V (l)	(W)
YG-04311	9.0	2000
YG-04316	12.0	2500
YG-04319	18.0	2500
YG-04321	25.0	3000

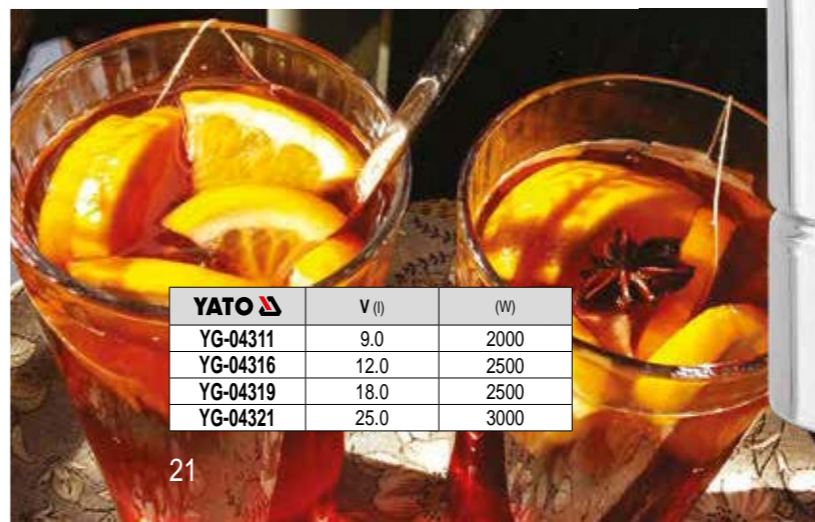

SS
STAINLESS STEEL

30-110°C



SS
STAINLESS STEEL

30-110°C



Vacuum flasks

- | | |
|-----------------------|--|
| DE Tischthermoskannen | ES Jarras y termos de mesa |
| RU Настольные термосы | FR Thermos isothermes pour la restauration |
| UK Столові термоси | PT Garrafa térmica de mesa |
| LT Stalo termosai | IT Thermos in acciaio |
| LV Galda termosī | BG Настолни термоси |
| CS Stolní termoska | EL Επιτραπέζιες θερμομονωτικές φιάλες |
| SK Stolové termosky | ZH 真空保温壶 |
| HU Asztali termoszok | |
| RO Termosuri | |



SS 201
STAINLESS STEEL

DOUBLE WALL

THERMAL ISOLATION



YATO	V (l)
YG-07013	1.5
YG-07014	2.0



YATO	V (l)
YG-07026	1.5
YG-07027	2.0



YATO	V (l)
YG-07016	2.2



YATO	V (l)
YG-07019	5.0
YG-07020	3.0

Drink dispenser

- | | |
|---------------------------|-----------------------------|
| DE Getränkespender | RO Dozator pentru băuturi |
| RU Диспенсер для напитков | ES Dispensador de bebidas |
| UK Дозатор для напоїв | FR Distributeur de boissons |
| LT Gėrimų dozatorius | PT Dispensador de bebidas |
| LV Dzērienu dozatori | IT Dispenser di bevande |
| CS Dávkovač na nápoje | BG Дозатор за напитки |
| SK Dávkovač na nápoje | EL Διανομέας ποτών |
| HU Italadagoló | ZH 果汁鼎 |



YATO	V (l)
YG-07001	8

- 8L**
- 350x260x600 mm**
- SS 201**
STAINLESS STEEL
- PC**
- COOLING**
- REMOVABLE BARELL**

Sauce dispensers

- | | |
|--------------------------|----------------------------|
| DE Soßenspender | ES Dispensadores de salsas |
| RU Диспенсеры для соусов | FR Distributeurs de sauce |
| UK Дозатори для соусів | PT Dispensadores de molhos |
| LT Sulčių dozatoriai | IT Dispenser di salse |
| LV Mērču dozatori | BG Дозатори за сосове |
| CS Dávkovač na omáčky | EL Διανομέας για σάλτσες |
| SK Dávkovač na omáčky | ZH 酱汁分配器 |
| HU Szószadagoló | |
| RO Dozator pentru sosuri | |



YG-00557
1x3L

YATO	V (l)	(mm)
YG-00557	3	185 x 185 x 355
YG-00558	6	365 x 185 x 355
YG-00559	9	545 x 185 x 355

YG-00559
3x3L

YG-00558
2x3L



- SS 304/201**
STAINLESS STEEL
- REMOVABLE CONTAINER INSIDE**



Jugs for drinks

DE Krüge für Getränke
RU Кувшины для напитков
UK Глечики для напоїв
LT Gėrimų ąsočiai
LV Dzērienu krūzes

CS Džbánky na nápoje
SK Džbánky na nápoje
HU Italkannák
RO Carafe
ES Jarras para bebidas
FR Pichets à boissons

PT Jarros de bebidas
IT Brocche per acqua
BG Кани за напитки
EL Κανάτες ποτών
ZH 冷水壺



YATO	V (l)	H (mm)	Ø (mm)
YG-07005	0.8	165	105
YG-07006	1.3	240	85
YG-07007	1.8	180	130



PC

Tiered platter for fruit and biscuits

DE Etage für Obst und Kekse
RU Этажерка для фруктов и печенья
UK Сервірувальна підставка для фрукти і печиво
LT Vaisių ir pyragų serviravimo stovas
LV Kūku un augļu paliknis
CS Mísa na ovoce a sušenky
SK Mísa na ovocie a zákusky
HU Gyümölcs és sütemény kínáló
RO Suport pentru fructe și prăjituri
ES Bandeja para frutas y pasteles
FR Plateau pour fruits et gâteaux
PT Tigela para frutas e bolos
IT Vassoio per frutta e torte
BG Поставка за сладки и плодове
EL Μπολ φρούτων και μπισκότων
ZH 不锈钢果盘



YATO	Ø (mm)	H (mm)
YG-08202	165 / 219 / 267	300

Ice cube tongs

DE Eiszange
RU Шипцы для льда
UK Шипці для льоду
LT Žnyplės ledui
LV Ledus stangas
CS Kleště na led
SK Kliešte na ľad
HU Jégcsipesz
RO Clește pentru cuburi de gheață
ES Alicates para hielo
FR Pince à glace
PT Pinças de gelo
IT Pinze per ghiaccio
BG Щипки за лед
EL Λαβίδα πάγου
ZH 冰块夹



YATO	L (mm)
YG-02735	100
YG-02736	150

Sugar cube tongs

DE Zuckerrange
RU Шипцы для сахара
UK Щипці для цукру
LT Žnyplės cukrui
LV Cukura stangas
CS Kleště na cukr
SK Kliešte na cukor
HU Cukorcsipesz
RO Clește pentru cuburi de zahăr
ES Alicates para azúcar
FR Pince à sucre
PT Pinças de açúcar
IT Pinze per zucchero
BG Щипки за захар
EL Λαβίδα ζάχαρης
ZH 方糖夹



YATO	L (mm)
YG-02733	155

Tongs

DE Zange
RU Щипцы
UK Щипці
LT Žnyplės
LV Stangas
CS Kleště
SK Kliešte
HU Csipesz
RO Clești
ES Alicates

FR Pince
PT Pinças
IT Pinze
BG Щипки
EL Λαβίδα
ZH 不锈钢夹



Bread serving tongs

YATO	L (mm)
YG-02731	220

Roast meat serving tongs

YATO	L (mm)
YG-02730	195

Spaghetti serving tongs

YATO	L (mm)
YG-02732	215

Buffet accessories

DE Buffetzubehör
RU Буфетные приборы
UK Буфетні аксесуари
LT Stalo serviravimo įrankiai
LV Bufešu piederumi
CS Bufetové pomůcky
SK Bufetové výrobky
HU Bűfé termékek
RO Accesorii buffet
ES Artículos para buffet
FR Pince buffet
PT Artigos de buffet
IT Articoli da buffet
BG Артикули за бюфет
EL Αντικείμενα για μπουφές
ZH 自助餐配件



Spaghetti spoon

YATO	L (mm)
YG-02780	340

Salad fork

YATO	L (mm)
YG-02778	300

Serving spoon

YATO	L (mm)
YG-02775	300

Slotted serving spoon

YATO	L (mm)
YG-02774	300

Slotted spoon

YATO	L (mm)
YG-02773	370

Ladle

- 120 ml

YATO	L (mm)
YG-02776	315

Sauce spoon

- 30 ml

YATO	L (mm)
YG-02777	300

Spatula

- 80 x 105 mm

YATO	L (mm)
YG-02772	360

Meat knife

YATO	L (mm)
YG-02771	315

Meat fork

YATO	L (mm)
YG-02770	280

Cake spatula

YATO	L (mm)
YG-02779	275

SS18/8
STAINLESS STEEL



Banquet trays

- DE Banketttablets
- RU Подносы банкетные прямоугольные
- UK Банкетні підноси
- LT Padėklai
- LV Banketu paplātes
- CS Banketní tácy
- SK Banketové podnosy
- HU Bankett tálcák
- FR Plateaux de banquet
- PT Bandejas de banquetes
- IT Vassoio per banchetti
- BG Банкетни подноси
- EL Δίσκοι για εορτές
- ZH 不锈钢盘
- RO Tăvi
- ES Bandejas para banquetes
- LT Ekspozicinis padėklas
- LV Ekspozīcijas paplāte
- CS Výstavní tácy
- SK Prezentačné podnosy
- HU Felszolgáló tálcá
- RO Tăvi pentru servit
- ES Bandeja expositoria
- FR Plateau de présentation
- PT Bandeja de exposição
- IT Vassoio espositivo
- BG Поднос
- EL Δίσκος εκθέσεως
- ZH 托盘



YG-02057

YG-02055

YATO	(mm)
YG-02055	220 x 150
YG-02057	380 x 240

Serving tray

- DE Präsentiertablett
- RU Декоративный прямоугольный поднос
- UK Теплоізоляційний контейнер для льоду
- LT Ekspozicinis padėklas
- LV Ekspozīcijas paplāte
- CS Výstavní tácy
- SK Prezentačné podnosy
- HU Felszolgáló tálcá
- RO Tăvi pentru servit
- ES Bandeja expositoria
- FR Plateau de présentation
- PT Bandeja de exposição
- IT Vassoio espositivo
- BG Поднос
- EL Δίσκος εκθέσεως
- ZH 托盘



SS18/8
STAINLESS STEEL



YATO	(mm)
YG-02056	305 x 215

Non-slip waiter trays

- DE Rutschfeste Kellnertablets
- RU Антискользящие подносы для официантов
- UK Нековзні підноси для офіціантів
- LT Neslidūs padėklai padavėjams
- LV Paplāte viesmilim, neslidoša
- CS Protiskluzové číšnícké tácy
- SK Čašnicke podnosy protišmykové
- HU Csúszásmentes pincértálcák
- RO Tăvi de servit anti-alunecare
- ES Bandejas antideslizantes para camareros
- FR Plateaux antidérapants pour serveurs
- PT Bandejas antiderrapantes para garçons
- IT Vassoio antiscivolo da cameriere
- BG Сервитьорски таблї с неплъзгаща горна част
- EL Αντιολισθητικοί δίσκοι σερβιτόρων
- ZH 防滑托盘

ANTI-SLIP SURFACE

FIBREGLOSS



Rectangular trays

YATO	(mm)
YG-02075	460 x 355
YG-02076	515 x 380
YG-02077	560 x 405
YG-02078	650 x 450

Round trays

YATO	Ø (mm)
YG-02079	355
YG-02080	405

Oval trays

YATO	(mm)
YG-02084	590 x 490
YG-02087	600 x 735



Buffet tray made of polypropylene

- DE Buffettablett
- RU Поднос
- UK Підноси
- LT Padėklas
- LV Paplāte
- CS Tácy
- SK Podnosy
- HU Tálcá
- RO Tăvi
- ES Expositoria
- FR Plateau
- PT Bandeja
- IT Vassoio
- BG Поднос
- EL Δίσκος
- ZH 托盘

PP



YATO	(mm)
YG-02105	430 x 300

Thermally insulated ice bucket

- DE Thermoisolierter Eisbehälter
- RU Термоёмкость для льда
- UK Теплоізоляційний контейнер для льоду
- LT Termoizoliacinis indas ledui
- LV Ledus termoss
- CS Termoizolační nádoba na led
- SK Termoizolačná nádoba na ľad
- HU Hőszigetelt jégartó
- RO Container termoizolant pentru gheață
- ES Contenedor de aislamiento térmico para hielo
- FR Conteneurs isothermes pour glace
- PT Recipiente de gelo com isolamento
- IT Contenitore a isolamento termico per il ghiaccio
- BG Съд за лед с двойни стени
- EL Θερμικώς μονωμένο δοχείο για πάγο
- ZH 保温冰桶

ABS/PP



YATO	V (l)	H (mm)	Ø (mm)
YG-07143	1.1	200	140

Ice bucket

- DE Eisbehälter
- RU Емкость для льда
- UK Контейнер для льоду
- LT Indas ledui
- LV Ledus trauks
- CS Nádoba na led
- SK Nádoba na ľad
- HU Jégartó
- RO Vas pentru gheață
- ES Contenedor para hielo
- FR Conteneur à glace
- PT Recipiente de gelo
- IT Contenitore per il ghiaccio
- BG Съд за лед
- EL Δοχείο πάγου
- ZH 亚克力冰桶

ACRYLIC



SEE ALSO
ice cube tongs



p. 24

YATO	V (l)	H (mm)	Ø (mm)
YG-07146	1.1	125	125

Wine bottle cooler

- DE Thermoisolierter Weinbehälter
- RU Термоконтейнер для вина
- UK Теплоізоляційний контейнер для вина
- LT Termoizoliacinis indas vynui
- LV Vīna termoss
- CS Termoizolační nádoba na víno
- SK Termoizolačná nádoba na víno
- HU Hőszigetelt bortartó
- RO Container termoizolant pentru sticle de vin
- ES Cubo enfriador de vino con aislamiento
- FR Seau à vin isotherme
- PT Recipiente de vinho com isolamento
- IT Contenitore a isolamento termico per il vino
- BG Термоизолиран съд за вино
- EL Θερμικώς μονωμένο δοχείο για κρασί
- ZH 酒瓶冷藏器

ACRYLIC



YATO	V (l)	H (mm)	Ø (mm)
YG-07147	1.4	235	125

Champagne bucket

- DE Sektkühler
- RU Ведро для шампанского
- UK Відро для шампанського
- LT Dubuo šampano buteliams
- LV Šampanieša spainis
- CS Nádoba na šampaňské
- SK Vedierko na šampanské
- HU Pezsgősvödör
- RO Frapieră
- ES Cubo de champán
- FR Vasque à champagne
- PT Balde para champanhe
- IT Vasca per champagne
- BG Кофичка за шампанско
- EL Κουβάς σαμπάνιας
- ZH 不锈钢香槟桶

SS201
STAINLESS STEEL
3.8L
Ø 180 mm



YATO	V (l)	Ø (mm)	H (mm)
YG-07141	3.8	80	196

Cocktail shakers

- DE Coctail-Shaker
- RU Шейкеры для коктейлей
- UK Шейкери для коктейлів
- LT Kokteilių plaktuvai
- LV Kokteīļu šeikeri
- CS Šejkr na koktejl
- SK Shakery na koktaily
- HU Koktél shakerek
- RO Shaker
- ES Cocteleras
- FR Shakers
- PT Coqueteleiras
- IT Agitatore per cocktail
- BG Шейкърї за коктейли
- EL Σέικερ κοκτέιλ
- ZH 不锈钢调酒壶

SS201
STAINLESS STEEL

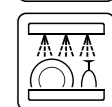

YATO	V (l)	Ø (mm)	H (mm)
YG-07121	0.5	70	178
YG-07123	0.7	80	248

Reception bell

DE Rezeptionsklingel
RU Звонок для рецепции
UK Дзвінок рецепції
LT Registratūros skambutis
LV Reserpcijas zvans
CS Reserční zvoněk
SK Reserčný zvonček
HU Reserpció csengő
RO Sonerie pentru recepție
ES Timbre de recepción
FR Cloche de réception
PT Sino de recepção
IT Campanello da reception

85 mm
CAST IRON



YATO	Ø (mm)
YG-02720	85

Citrus juicer

DE Zitruspresse
RU Ручная соковыжималка для цитрусовых
UK Прес для цитрусових
LT Rankinė sulčiaspaudė citrusams
LV Citrusaugļu sulu spiede
CS Lis na citrusy
SK Lis na citrón
HU Citrusfacsaró
RO Storcător de citrice
ES Exprimidor de cítricos
FR Extracteur de jus d'agrumes
PT Espremedor de frutas cítricas
IT Spremiagrumi
BG Цитрус преса
EL Αποχυμωτής εσπεριδοειδών
ZH 不锈钢榨汁器

SS202
STAINLESS STEEL



YATO	Ø (mm)	Ø CONE (mm)
YG-07108	120	65

Bartender container

DE Barkeeper-Behälter
RU Ящик для бармена
UK Барменський контейнер
LT Barmeno indas
LV Bāra trauks
CS Barmanská nádoba
SK Barmanská nádoba
HU Bár doboz
RO Recipient depozitare pentru bar
ES Recipiente de bar
FR Bac à compartiments
PT Recipiente de barman
IT Contenitore per bar
BG Бар органайзер за плодове
EL Δοχείο μπάρμαν
ZH 果盒调味盒

X5 COMPARTMENTS
ABS
PP PC



YATO	H (mm)
YG-07080	500 x 160 x 100

Bartending spoon

DE Barlöffel
RU Барная ложка
UK Барменська ложка
LT Barmeno šaukštėlis
LV Bāra karote
CS Barmanská lžička
SK Barmanská lyžička
HU Koktélikanál
RO Liguriță pentru barman
ES Cuchara con mango largo

330 mm
SS18/0
STAINLESS STEEL



YATO	L (mm)
YG-07136	330

Bartender's organiser

DE Behälter für Barkeeper-Zubehör
RU Барный органайзер
UK Контейнер для барменського приладдя
LT Padėklas barmeno įrankiams
LV Trauks bāra piederumiem
CS Nádoba na barmanské příslušenství
SK Nádoba na barmanské príbory
HU Bártartozék tároló
RO Organizator bar
ES Contenedor para accesorios de barman

X6 SEGMENTS
ABS
FR Bac caddy
PT Recipiente para acessórios de barman
IT Contenitore per accessori per bar
BG Бар органайзер
EL Δοχείο για αξεσουάρ μπάρμαν
ZH 纸巾盒

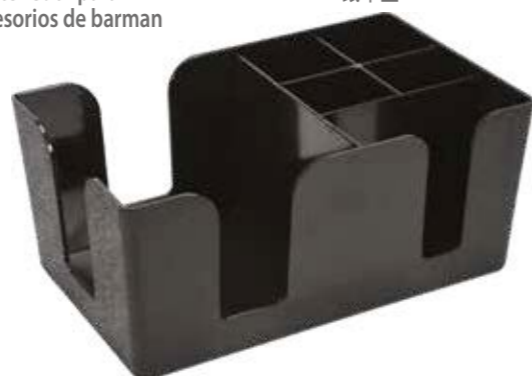

YATO	H (mm)
YG-07134	100

Glass rimmer

DE Krustenmacher
RU Риммер
UK Крастовка
LT Stovai taurių dekoravimui
LV Bāra organizātors glāžu dekorēšanai
CS Zdobítčko skleniček
SK Nástroj na dekorovanie pohárov
HU Koktél szervíz
RO Rimmer pentru pahare
ES Escarchador
FR Sel de cocktail coffret barman
PT Acessório de decoração de taças

ABS



IT Guarnitore bordi bicchieri
BG Сет за украсяване на чаши за коктейли
EL Glass rimmer για κοκτέιλ
ZH 调味盒

YATO	H (mm)	Ø (mm)
YG-07102	70	150

Bartender mats

DE Barkeeper-Matten
RU Барные коврики
UK Коврики для барменів
LT Baro kilimėliai
LV Bāra paklāji
CS Barmanské podložky
SK Barmanské rohože
HU Bár alátét
RO Suporturi pentru bar
ES Esteras de goma para la barra
FR Tapis de bar en caoutchouc

PT Tapetes de barman
IT Tappetino da bar
BG Бар подложки
EL Μπάρ ψάθες
ZH 长吧垫

TPR



YATO	H (mm)
YG-07100	590 x 80 x 15
YG-07101	460 x 310 x 10

Drink dispensers

DE Barkeeper-Spender
RU Диспенсеры для бара
UK Барменські диспенсери
LT Baro buteliukai skysčiams dozuoti
LV Bāra dispenserī
CS Barmanské dávkovače
SK Barmanské dispenzéry
HU Adagoló tubusok
RO Barman dispenser
ES Dispensadores de barman
FR Flacon verseur
PT Distribuidores para barman
IT Dispenser per bar
BG Бар диспенсери
EL Διανομείς μπάρμαν
ZH 饮料壶

1 L

PP/PS

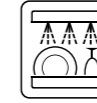

YATO	COLOUR	V (l)	H (mm)	Ø (mm)
YG-07115	Red	1	330	90
YG-07116	Blue	1	330	90
YG-07117	Green	1	330	90
YG-07118	Brown	1	330	90
YG-07119	Yellow	1	330	90

Bottle opener

DE Flaschenöffner
RU Открывалка для бутылок
UK Відкривачка для пляшок
LT Butelių atidarytuvas
LV Pudedļu attaisāmais
CS Otevírač na láhve
SK Otvárač na fľaše
HU Sörbontó
RO Desfacător de sticle

SS
STAINLESS STEEL



YATO	H (mm)
YG-07139	175 x 40 x 2

Plugs with dispensers

DE Ausgießer
RU Пробки с дозаторами
UK Пробки з дозаторами
LT Kamščiai su dozatoriais
LV Korķi ar dozatoriem
CS Korky s dávkovači
SK Zátky s dávkovačmi
HU Adagoló kupak

PP



YATO	COLOUR
YG-07126	Blue
YG-07127	Pink
YG-07128	Red
YG-07129	Black
YG-07130	Green
YG-07131	White

Plug with dispenser

DE Ausgießer
RU Пробка с дозатором
UK Пробка з дозатором
LT Kamštis su dozatoriumi
LV Korķis ar dozatoru
CS Korek s dávkovačem
SK Zátka s dávkovačom
HU Adagoló dugó
RO Picurător din oțel inoxidabil
ES Tapón con dosificador para botellas
FR Bec verseur pour les bouteilles

SS
STAINLESS STEEL

TPR



YATO	COLOUR
YG-07125	Black



Bone saw

- DE Knochensäge
- RU Костяная пила
- UK Пилка для кісток
- LT Kaulų pjūklas
- LV Kaulu zāģis
- CS Pila na kosti
- SK Pila na kosti
- HU Csontfűrész
- RO Fierastrau de oase si carne congelată
- ES Sierra para huesos
- FR Scie à os
- PT Serra de osso
- IT Segatrice
- BG Трион за кости
- EL Πριόνι κρέατος οστών
- ZH 锯骨机



750W	1650 mm BLADE	MAX 245 mm CUTTING HIGH
1400 min⁻¹ CUTTING SPEED	3-180 mm SLICES	Al-Mg ANODIZED
	SS STAINLESS STEEL	



YATO	(W)	(mm)	TABLE (mm)
YG-03392	750	870 x 450 x 465	440 x 465

Meat mincer with Unger system

- DE Fleischwolf
- RU Машина для измельчения мяса
- UK Машинка для подрібнення м'яса
- LT Mėsmalė
- LV Gaļas maļamā mašina
- CS Sroj pro mletí masa
- SK Mlynček na mäso
- HU Húsdaráló
- RO Maşina de tocat carne
- ES Picadora de carne
- FR Hachoir à viande
- PT Moedor de carne
- IT Macchina per la macinazione della carne
- BG Месомелачка
- EL Μηχανή για άλεση κρέατος
- ZH 碎肉机

Al-Mg ANODIZED	SS STAINLESS STEEL	PE	EMERGENCY STOP SWITCH		x2 10 mm	6 mm
--------------------------	------------------------------	-----------	------------------------------	--	---------------------------	-------------

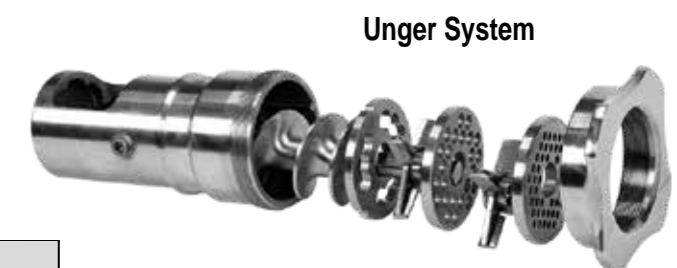

YATO	(kg/h)	(W)	(mm)
YG-03232	220	1100	520 x 390 x 225

Sausage stuffers

- DE Wurstfüller
- RU Колбасные шприцы
- UK Шприци для ковбас
- LT Dešrų kimštuvai
- LV Desu pildīšanas ierīces
- CS Nadívače klobás
- SK Plniace stroje na výrobu klobásy
- HU Kolbásztöltő
- RO Aparat de umplut cârnați
- ES Embutidora de salchichas
- FR Remplisseuse de saucisses
- PT Enchedores de linguiças
- IT Riempitrici per salsicce
- BG Пълначка за колбаси
- EL Γεμιστικά για λουκάνικα
- ZH 灌肠机



- SS**
STAINLESS STEEL
- x4**
RUBBER FEET
- 16 mm
22 mm
32 mm
38 mm
- x2**
SPEED
- EASY TO CLEAN**



YATO	V (l)	(kg/h)	(mm)	CYLINDER (mm)
YG-03350	3	11	300 x 340 x 570	140 x 200
YG-03360	5	12	300 x 340 x 690	140 x 320
YG-03370	7	13	300 x 340 x 830	140 x 460
YG-03380	15	17	370 x 330 x 710	219 x 400

Hamburger presses

- DE Hamburgerpressen
- ES Prensas para hamburguesas
- RU Пресс для гамбургеров
- FR Presse-hamburger
- UK Преси для гамбургерів
- PT Prensas de hamburguesas
- LT Mėsainių presai
- IT Presse per hamburger
- LV Hamburgeru preses
- BG Преса за хамбургери
- CS Lisy na hamburgery
- EL Πρέσα χάμπουρκερ
- SK Lisy na hamburgery
- ZH 汉堡机
- HU Hamburger prések
- RO Presă pentru hamburgeri



YATO	Ø (mm)
YG-03400	100
YG-03405	130



- SS**
STAINLESS STEEL
- x4**
RUBBER FEET

Meat and cheese slicers

- DE Schneidemaschinen für Wurst und Käse
- RU Ломтерезки для колбас и сыра
- UK Скиборізки для м'яса і сирів
- LT Dešrų, kumprių ir sūrių pjaustyklės
- LV Griezējierīces žāvējumiem un sieriem
- CS Kráječ na uzeniny a sýry
- SK Rezače stroje na údeniny a syry
- HU Kolbász- és sajtszeletelő
- RO Feliatoare pentru carne și mezeluri
- ES Cortafiambres y loncheadoras para queso
- FR Trancheuses à viande et à fromage
- PT Cortadores de frios e queijos
- IT Affettatrici per salumi e formaggi
- BG Машини за рязане на колбаси и сирена
- EL Κόφτες για λουκάνικα και τυρί
- ZH 肉和奶酪切片机



YG-03110

- maximum diameter of sliced products: 150 mm
- slice thickness: 0.2-12 mm



YG-03118

- maximum diameter of sliced products: 180 mm
- slice thickness: 0.2-12 mm



YG-03120

- maximum diameter of sliced products: 180 mm
- slice thickness: 0.2-12 mm



YG-03130

- maximum diameter of sliced products: 200 mm
- slice thickness: 0.2-15 mm



YATO	(W)	Ø (mm)	TABLE (mm)	(mm)
YG-03110	120	220	200 x 230	470 x 340 x 370
YG-03118	150	250	200 x 230	470 x 360 x 410
YG-03120	150	250	200 x 230	470 x 380 x 410
YG-03130	250	300	255 x 275	530 x 450 x 450

Tomato slicers

DE Schneidemaschinen für Tomaten
RU Слайсеры для томатов
UK Слайсери для томатів
LT Pomidorų pjaustyklės
LV Griezējierīces tomātiem
CS Kráječ na rajčata
SK Krájač paradajok
HU Paradicsom szeletelő
RO Feliatoare pentru roșii

ES Cortadoras de tomate
FR Coupe-tomates
PT Cortadores de tomate
IT Affettatrici per pomodori
BG Резачки за домати
EL Κόφτες για ντομάτες
ZH 番茄切片機



SS
STAINLESS STEEL

SLIDING BAR
BELOW BODY

X4
SUCTION PADS

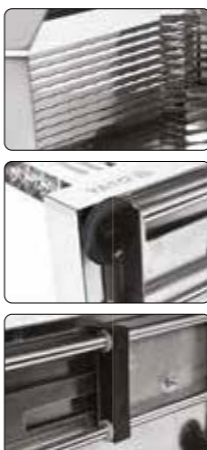

YG-03410

x13
BLADES

4.0
mm
CUTTING THICKNESS

YG-03415

x10
BLADES

5.5
mm
CUTTING THICKNESS



YATO
YG-03410
YG-03415

Tomato slicers

DE Schneidemaschinen für Tomaten
RU Слайсеры для томатов
UK Слайсери для томатів
LT Pomidorų pjaustyklės
LV Griezējierīces tomātiem
CS Kráječ na rajčata
SK Krájač paradajok
HU Paradicsom szeletelő
RO Feliatoare pentru roșii
ES Cortadoras de tomate
FR Coupe-tomates
PT Cortadores de tomate
IT Affettatrici per pomodori
BG Резачки за домати
EL Κόφτες για ντομάτες
ZH 番茄切片機



SS
STAINLESS STEEL

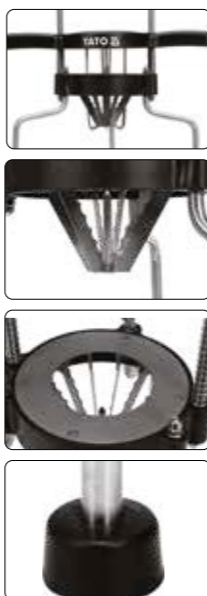

YATO	PARTS (pcs.)	H (mm)	Ø (mm)
YG-03420	6	480	350
YG-03421	12	480	350

Vegetable shredder

DE Gemüsehobel
RU Овощерезка
UK Нарізний пристрій для овочів
LT Daržovių pjaustyklė
LV Dārzeņu smalcinātājs
CS Sekáček na zeleninu
SK Krájač zeleniny
HU Zöldségvágó
RO Tocător pentru legume
ES Trituradora de verduras
FR Broyeur legume
PT Cortador de legumes
IT Trituratore di verdure
BG Резачка за зеленчуци
EL Κόπτης λαχανικών
ZH 蔬菜切碎机

Al-Mg
ANODIZED

550W

300kg/h
EFFICIENCY

x5
CUTTING KNIVES

EMERGENCY
STOP
SWITCH



YATO	(kg/h)	(W)	(mm)
YG-03100	300	550	560 x 580 x 240

Accessories for vegetable shredder

- DE Zubehör für Gemüseschredder
 RU Аксессуары для тритачки овощей
 UK Аксесуари для подрібнювача овочів
 LT Priedai daržovių smulkintuvui
 LV Aksesuāri dāržu smalcinātājam
 CS Přslušenství pro skartovač zeleniny
- SK Príslušenstvo k drviču zeleniny
 HU Tartozékok növényi aprítóhoz
 RO Accesorii pentru tocător de legume
 ES Accesorios para trituradora de verduras
 FR Accessoires pour broyeur de légumes
 PT Acessórios para trituradora de vegetais

- IT Accessori per tritacarne
 BG Аксесоари за раздробяване на зеленчуци
 EL Αξεσουάρ για τεμαχιστή λαχανικών
 ZH 蔬菜切碎机配件

∅ 205 mm

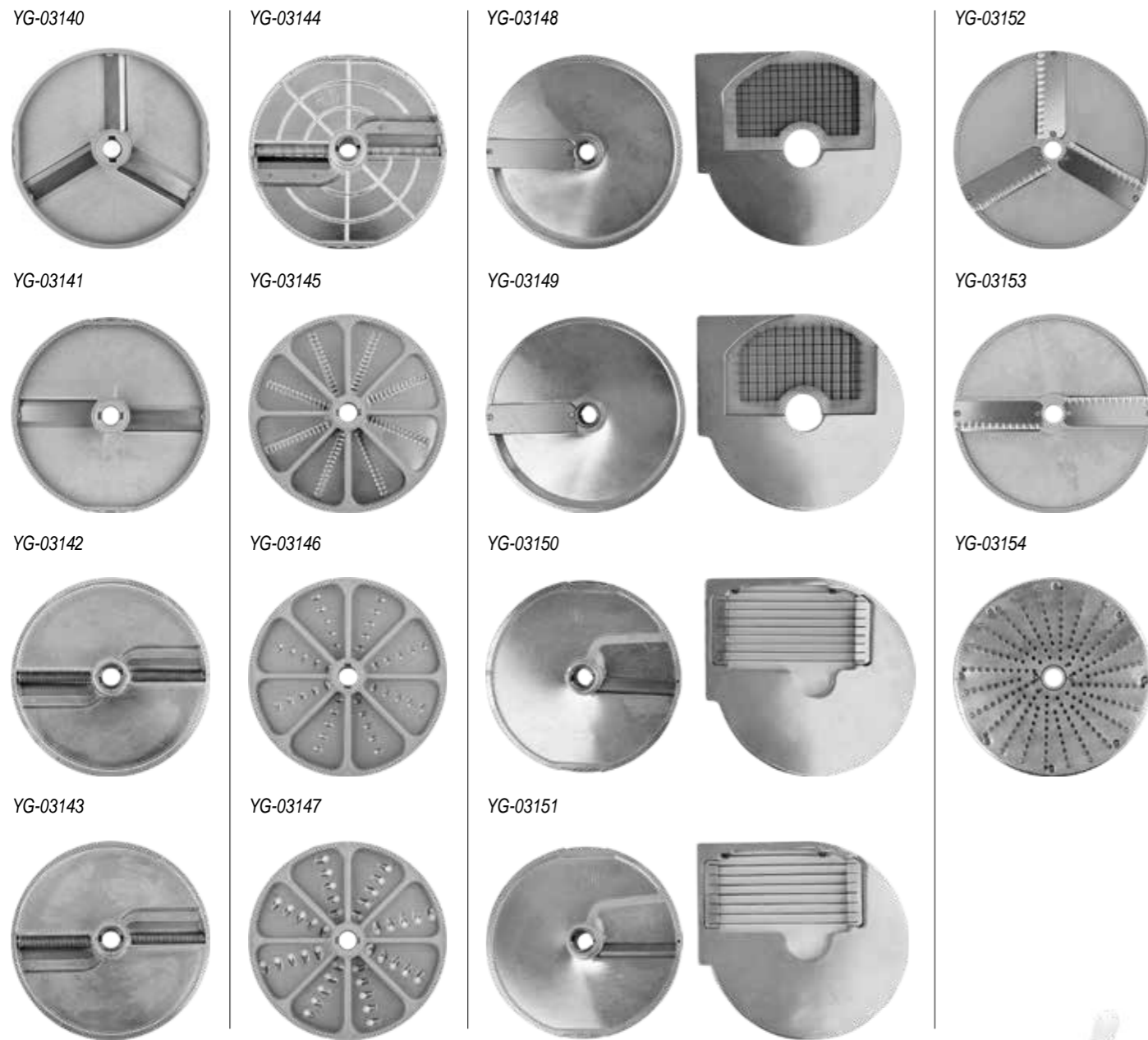

YATO	TYPE	THICKNESS (mm)
YG-03140	SLICES	2
YG-03141	SLICES	4
YG-03142	JULIENNE	2.5 x 2.5
YG-03143	JULIENNE	4 x 4
YG-03144	JULIENNE	10 x 10
YG-03145	SHREDS	3
YG-03146	SHREDS	4
YG-03147	SHREDS	7
YG-03148	CUBES	8 x 8 x 8
YG-03149	CUBES	10 x 10 x 10
YG-03150	CHIPS	8 x 8
YG-03151	CHIPS	10 x 10
YG-03152	WAVY SLICES	2
YG-03153	WAVY SLICES	4
YG-03154	GRATER	-



Potato peelers

- DE Kartoffelschäler
 RU Картофелечистка
 UK Пристрої для чищення картоплі
 LT Bulvių skutyklės
 LV Kartupeļu mizotāji
 CS Oběrač brambor
 SK Škrabky na zemiaky
 HU Burgonyahámzó
 RO Mașină de curățat cartofi
 ES Peladoras de patatas
 FR Éplucheuses de pommes de terre
 PT Descascadores de batata
 IT Pelapatate
 BG Машини за белене на картофи
 EL Αποφλοιωτές πατάτας
 ZH 马铃薯削皮器



YATO	V (l)	INSERT (kg)	(kg/h)	(W)
YG-03087	15	10	165	750
YG-03090	20	15	225	950



Handheld blender

- DE Handmixer
 RU Ручной блендер
 UK Ручні блендер
 LT Rankinis maišytuvas
 LV Rokas blenderis
 CS Ruční mixér
 SK Ručný mixér
 HU Botmixer
 RO Blender de mana
 ES Batidora de mano
 FR Mélangeur à main
 PT Mixer de mão
 IT Frullatore
 BG Ръчен блендър
 EL Μίξερ χειρό
 ZH 手动搅拌器

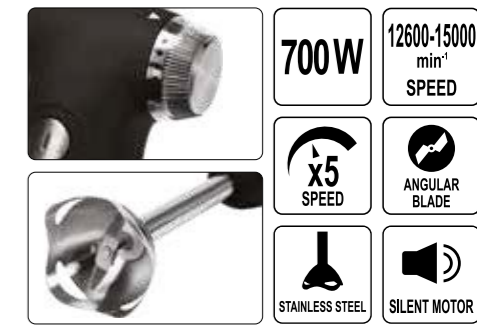

YATO	(W)
YG-03006	700

Bartender's blender

DE Barkeepermischer
RU Блендер бармена
UK Барменський блендер
LT Barmeno maišytuvas-smulkintuvas
LV Bāra blenderis
CS Barmanský mixér
SK Barmanský mixér
HU Bármixer
RO Blender
ES Batidora de barman
FR Mélangeur à cocktail
PT Liquidificador para barman
IT Frullatore da bar
BG Бар блендър
EL Μπλέντερ μπάρμαν
ZH 调酒师搅拌机

1680W 32000 min⁻¹ SPEED PULS SPEED SILENT MOTOR SPEED 2500 ml SS 420 BPA FREE X4 RUBBER FEET



YATO	V (l)	(W)	(mm)
YG-07085	2.5	1680	220 x 260 x 540

Additional cup for the blender

DE Ersatz-Mixbecher
RU Запасная чаша для блендера
UK Запасна чаша для блендера
LT Papildomas maišytuvo-smulkintuvo ąsotis
LV Blendera rezerves krūze
CS Náhradní nádoba k mixéru
SK Náhradná nádoba pre mixér
HU Tartalék mixertál
RO Cupă pentru blender
ES Vaso de repuesto para la batidora

FR Gobelet de rechange pour le mélangeur
PT Copo de liquidificador sobressalente
IT Bicchieri di ricambio per frullatore
BG Резервна кана за блендър
EL Επιπλέον πλαστική κανάτα για μπλέντερ
ZH 搅拌机备用杯



YATO	V (l)	(mm)	FOR:
YG-07086	2.5	190 x 250 x 335	YG-07085



Planetary mixer

DE Planetenmischer
RU Планетарный миксер
UK Планетарний міксер
LT Planetarinis maišytuvas
LV Planetārais mikseris
CS Planetární mixér
SK Planétová miešačka
HU Bolygókeverő

RO Mixer planetar
ES Mezclador planetario
FR Mélangeur planétaire
PT Batedeira
IT Miselatore planetario
BG Планетарен миксер
EL Πλανητικός αναδευτήρας
ZH 搅拌机

7L 0-780 min⁻¹ SPEED 350W SS STAINLESS STEEL



YATO	(W)	V (l)	(min ⁻¹)	(mm)	Ø KNEADING-TROUGH (mm)	(kg)
YG-03012	350	7	0-780	420 x 400 x 230	220/230	17

Planetary mixers

- | | |
|-----------------------------|----------------------------|
| DE Planetenmischer | ES Mezcladores planetarios |
| RU Планетарные миксеры | FR Mélangeurs planétaires |
| UK Планетарні міксери | PT Batedeiras |
| LT Planetariniai maišytuvai | IT Miscelatori planetari |
| LV Planetārie mikseri | BG Планетарни миксери |
| CS Planetární mixéry | EL Πλανητικοί αναδευτήρες |
| SK Planétové miešacky | ZH 搅拌机 |
| HU Bolygókeverők | |
| RO Mixere planetare | |



Planetary mixer

- | | |
|----------------------------|---------------------------|
| DE Planetenmischer | RO Mixer planetar |
| RU Планетарный миксер | ES Mezclador planetario |
| UK Планетарний міксер | FR Mélangeur planétaire |
| LT Planetarinis maišytuvas | PT Batedeira |
| LV Planetārais mikseris | IT Miscelatore planetario |
| CS Planetární mixér | BG Планетарен миксер |
| SK Planétová miešacka | EL Πλανητικός αναδευτήρας |
| HU Bolygókeverő | ZH 搅拌机 |



YATO	(W)	V (l)	(min ⁻¹)	(mm)	Ø KNEADING-TROUGH (mm)	(kg)
YG-03020	500	15	110/178/355	680 x 475 x 365	270/300	59
YG-03021	1100	20	104/187/365	780 x 500 x 430	320/350	85
YG-03022	1100	30	104/187/365	850 x 540 x 430	340/370	91

YATO	(W)	V (l)	(min ⁻¹)	(mm)	Ø KNEADING-TROUGH (mm)	(kg)
YG-03023	2200	40	104/206/399	990 x 640 x 520	400/420	152

Planetary mixers

- DE Planetenmixer
- RU Планетарные миксеры
- UK Планетарні міксери
- LT Planetariniai maišytuvai
- LV Planetārie mikseri
- CS Planetární mixéry
- SK Planétové miešačky
- HU Bolygókeverők
- RO Mixere planetare
- ES Mezcladores planetarios
- FR Mélangeurs planétaires
- PT Batedeiras
- IT Miscelatori planetari
- BG Планетарни миксери
- EL Πλανητικοί αναδευτήρες
- ZH 搅拌机

YG-03025

10L

500W



YG-03026

25L

750W



YATO	(W)	V (l)	(min ⁻¹)	(mm)	Ø KNEADING-TROUGH (mm)	(kg)
YG-03025	500	10	110/178/355	680 x 460 x 370	245/275	63
YG-03026	750	25	110/200/420	840 x 550 x 435	335/370	82

Kneading-troughs for planetary mixers

- DE Bottiche für Planetenmixer
- RU Дежи для планетарных миксеров
- UK Дежа для планетарних міксерів
- LT Planetarinių maišytuvų dubenys
- LV Bļodas planetārajiem mikseriem
- CS Dž pro planetární mixéry
- SK Misy pre planétové miešačky
- HU Tál bolygókeverőkhoz
- RO Boluri pentru mixer planetar
- ES Recipientes para mezcladoras planetarias
- FR Récipients pour mélangeurs planétaires
- PT Tigelas para batedeiras
- IT Sbattitori per i miscelatori planetari
- BG Купи за планетарни миксери
- EL Κάδοι για πλανητικούς αναδευτήρες
- ZH 搅拌机料筒

YATO	FOR:	V (l)
YG-03125	YG-03025	10
YG-03126	YG-03026	25



YG-03125

YG-03126

Planetary mixers

- DE Planetenmixer
- RU Планетарные миксеры
- UK Планетарні міксери
- LT Planetariniai maišytuvai
- LV Planetārie mikseri
- CS Planetární mixéry
- SK Planétové miešačky
- HU Bolygókeverők
- RO Mixere planetare
- ES Mezcladores planetarios
- FR Mélangeurs planétaires
- PT Batedeiras
- IT Miscelatori planetari
- BG Планетарни миксери
- EL Πλανητικοί αναδευτήρες
- ZH 搅拌机



YATO	(W)	V (l)	(min ⁻¹)	(mm)	Ø KNEADING-TROUGH (mm)	(kg)
YG-03027	1100	35	80/160/388	1020 x 640 x 550	375/395	130
YG-03028	1500	40	80/160/388	1020 x 640 x 550	400/420	132
YG-03029	2000	60	74/155/388	1250 x 750 x 570	460/490	218

Kneading-troughs for planetary mixers

- DE Bottiche für Planetenmixer
- RU Дежи для планетарных миксеров
- UK Дежа для планетарних міксерів
- LT Planetarinių maišytuvų dubenys
- LV Bļodas planetārajiem mikseriem
- CS Dž pro planetární mixéry
- SK Misy pre planétové miešačky
- HU Tál bolygókeverőkhoz
- RO Boluri pentru mixer planetar
- ES Recipientes para mezcladoras planetarias
- FR Récipients pour mélangeurs planétaires
- PT Tigelas para batedeiras
- IT Sbattitori per i miscelatori planetari
- BG Купи за планетарни миксери
- EL Κάδοι για πλανητικούς αναδευτήρες
- ZH 搅拌机料筒

YATO	FOR:	V (l)
YG-03127	YG-03027	35
YG-03128	YG-03028	40
YG-03129	YG-03029	60

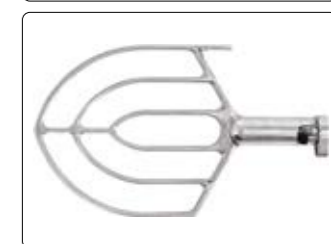
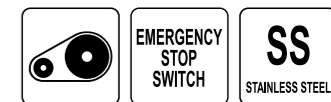

Spiral mixers

DE Spalrmixer
RU Спиральные миксеры
UK Спиральні міксери
LT Spiraliniai maišytuvai
LV Spirālie mikseri
CS Spirálové míxéry
SK Spirálové miešáčky
HU Spirál keverők
RO Malaxore pentru aluat
ES Amasadoras de espiral
FR Mélangeur à spirale
PT Batedeiras espirais
IT Miscelatori a spirale
BG Спирални миксери
EL Σπριικοί αναμκτήρες
ZH 和面机



Spiral mixers

DE Spalrmixer
RU Спиральные миксеры
UK Спиральні міксери
LT Spiraliniai maišytuvai
LV Spirālie mikseri
CS Spirálové míxéry
SK Spirálové miešáčky
HU Spirál keverők
RO Malaxore pentru aluat
ES Amasadoras de espiral
FR Mélangeur à spirale
PT Batedeiras espirais
IT Miscelatori a spirale
BG Спирални миксери
EL Σπριικοί αναμκτήρες
ZH 和面机

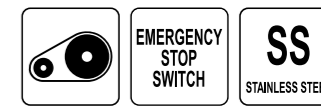

YATO	(W)	V (l)	(min ⁻¹)	(mm)	Ø KNEADING-TROUGH (mm)	(kg)
YG-03059	1100	20	158	690 x 760 x 390	360/390	127
YG-03062	1500	30	158	760 x 800 x 440	400/430	138

YATO	(W)	V (l)	(min ⁻¹)	(mm)	Ø KNEADING-TROUGH (mm)	(kg)
YG-03060	1100	20	207	860 x 700 x 390	360/390	89
YG-03063	1500	30	207	890 x 730 x 430	400/430	94

Spiral mixers

- DE Spiralmixer
- RU Спиральные миксеры
- UK Спіральні міксери
- LT Spiraliniai maišytuvai
- LV Spirālie mikseri
- CS Spirálové mixéry
- SK Spirálové miešačky
- HU Spirál keverők
- RO Malaxore pentru aluat
- ES Amasadoras de espiral
- FR Mélangeur à spirale
- PT Batedeiras espirais
- IT Miscelatori a spirale
- BG Спирални миксери
- EL Σπριρικοί αναμκτήρες
- ZH 和面机

3100W  EMERGENCY STOP SWITCH **SS**
STAINLESS STEEL

YG-03068

50L



YG-03065

40L



YG-03065



YG-03068



YATO	(W)	V (l)	(min ⁻¹)	(mm)	Ø KNEADING-TROUGH (mm)	(kg)
YG-03065	3100	40	125/250	1030 x 730 x 480	450/480	133
YG-03068	3100	50	120/240	1120 x 880 x 530	500/530	189

Induction cookers

- DE Induktionskochplatten
- RU Индукционные плиты
- UK Індукційні плити
- LT Indukcinės viryklės
- LV Indukcijas plītis
- CS Idukcční plotny
- SK Indukčné variče
- HU Indukciós főzőlapok
- RO Plite cu inducție
- ES Cocinas de inducción
- FR Cuisinières induction
- PT Fogões por indução
- IT Cucine a induzione
- BG Индукционни котлони
- EL Επαγωγικές κουζίνες
- ZH 电磁炉



500-3500 W 1-10 POWER LEVELS Ø 140-260 mm
CERAMIC GLASS OVERHEATING PROTECTION **SS**
STAINLESS STEEL



- stepless power adjustment within the scope of 500-3500 W (in 100 W steps)
- manual control



YATO	(mm)	(W)
YG-04700	325 x 420 x 105	500-3500



MANUAL CONTROL



- power setting from 1 to 10 (within the scope of 500-3500 W, in 100 W steps)
- temperature setting from 1-10 (60-240°C, in 20°C steps)
- timer setting from 0 to 180 minutes (0-30 min. in 1 min. steps, 30-180 min. in 10 min. steps)
- LED display
- electronic control



YATO	(mm)	(W)
YG-04701	325 x 420 x 105	500-3500



DIGITAL CONTROL

0-180min
TIMER LED
DISPLAY



Grill plates

- DE Grillplatten
- RU Гриль-плиты
- UK Плити з грилем
- LT Grilio plokštės
- LV Grila plāksnes
- CS Grilovací desky
- SK Grilovacie dosky
- HU Grill sütőlapok
- RO Grill electric
- ES Placas de parrilla
- FR Plaque à grillade
- PT Chapas grill
- IT Piastra grill
- BG Грилове
- EL Πλάκες σχάρας
- ZH 电扒炉

SS
STAINLESS STEEL

50-300
°C
WORKING
TEMPERATURE



• flat surface

YATO	(W)	(mm)	PLATE (mm)	(kg)
YG-04584	2000	365 x 460 x 220	360 x 380 x 6	13.5



• flat surface

YATO	(W)	(mm)	PLATE (mm)	(kg)
YG-04585	3000	555 x 430 x 230	550 x 350 x 9	18.5



• 2/3 flat surface, 1/3 grooved surface

YATO	(W)	(mm)	PLATE (mm)	(kg)
YG-04586	3000	555 x 430 x 230	550 x 350 x 9	18.5



• grooved surface

YATO	(W)	(mm)	PLATE (mm)	(kg)
YG-04587	3000	555 x 430 x 230	550 x 350 x 9	18.5



• flat surface
• two independently controlled heating zones

YATO	(W)	(mm)	PLATE (mm)	(kg)
YG-04588	2200 + 2200	735 x 510 x 230	730 x 420 x 9	26

Contact grills

- DE Kontaktgrills
- RU Контактные грили
- UK Контактні грилі
- LT Kontaktiniai griliai
- LV Kontakta grili
- CS Kontaktní grily
- SK Kontaktné grily
- HU Kontakt grill
- RO Contact grill
- ES Parrillas de contacto
- FR Grilles de contact
- PT Grelhas de contato
- IT Griglie di contatto
- BG Контактни грилове
- EL Τοστιέρας-γκριλιέρας
- ZH 电气烧烤炉

SS
STAINLESS STEEL

50-300
°C
WORKING
TEMPERATURE



YATO	(W)	(mm)	PLATE (mm)	(kg)
YG-04555	1800	310 x 370 x 205	230 x 225	15

YATO	(W)	(mm)	PLATE (mm)	(kg)
YG-04556	1800	310 x 370 x 215	230 x 225	15



YATO	(W)	(mm)	PLATE (mm)	(kg)
YG-04558	2200	440 x 370 x 190	345 x 230	18



YATO	(W)	(mm)	PLATE (mm)	(kg)
YG-04557	2200	440 x 370 x 190	345 x 230	18

Gas-fired grill

- DE Gasgrill
- RU Газовый гриль
- UK Газовий гриль
- LT Dujinis grilis
- LV Gāzes grils
- CS Plynový gril
- SK Plynový gril
- HU Gázgrill
- RO Grătar cu gaz
- ES Barbacoa de gas
- FR Barbecue au gaz
- PT Churrasqueira a gás
- IT Barbecue a gas
- BG Газов грил
- EL Σχάρα αερίου
- ZH 燃气烧烤炉

9 kW	x3	3 LED KNOBS	2 SHELVES WITH HANGERS
------	----	----------------	------------------------------



YATO	(kW)	(mm)	GRATE (mm)	LATTICE (mm)	(kg)
YG-20001	9	1220 x 590 x 1120	570 x 410	570 x 120	26.5



YATO	(W)	(mm)	PLATE (mm)	(kg)
YG-04560	3600	580 x 360 x 190	485 x 230	24



Gas-fired grills

- | | |
|---------------------|-------------------------|
| DE Gasgrills | RO Grătare cu gaz |
| RU Газовые грили | ES Barbacoas de gas |
| UK Газові грилі | FR Barbécues à gaz |
| LT Dujiniai griliai | PT Churrasqueiras a gás |
| LV Gāzes grili | IT Barbecue a gas |
| CS Plynové grily | BG Газови грилове |
| SK Plynové grily | EL Σχάρες αερίου |
| HU Gázgrillek | ZH 燃气烤架 |

SS
STAINLESS STEEL

360°
4x

4x
BRAKE



YG-20002

9.0 kW
+2.5 kW

3+1



YG-20011

12.0 kW
+2.5 kW

4+1



YATO	(kW)	(mm)	GRATE (mm)	LATTICE (mm)	(kg)
YG-20002	11.5	1220 x 570 x 1120	600 x 420 (2 pcs.)	570 x 120	32
YG-20011	14.5	1330 x 570 x 1120	700 x 420 (3 pcs.)	675 x 120	36

Gas-fired grills

- | | |
|---------------------|-------------------------|
| DE Gasgrills | RO Grătare cu gaz |
| RU Газовые грили | ES Barbacoas de gas |
| UK Газові грилі | FR Barbécues à gaz |
| LT Dujiniai griliai | PT Churrasqueiras a gás |
| LV Gāzes grili | IT Barbecue a gas |
| CS Plynové grily | BG Газови грилове |
| SK Plynové grily | EL Σχάρες αερίου |
| HU Gázgrillek | ZH 燃气烤架 |

4+1

360°
4x

360°
4x

4x
BRAKE



YG-20012
14.0 kW
+2.0 kW



YATO	(kW)	(mm)	GRATE (mm)	LATTICE (mm)	(kg)
YG-20012	16	1330 x 630 x 1130	680 x 440 (3 pcs.)	660 x 160	40.5



YG-20013
14.0 kW
+3.5 kW



YATO	(kW)	(mm)	GRATE (mm)	LATTICE (mm)	(kg)
YG-20013	17.5	1470 x 580 x 1270	650 x 460 (2 pcs.)	680 x 170	59.5

Gas-fired grill

- DE Gasgrill
- RU Газовый гриль
- UK Газовий гриль
- LT Dujinis grilis
- LV Gāzes grils
- CS Plynový gril
- SK Plynový gril
- HU Gázgrill
- RO Grătar cu gaz
- ES Barbacoa de gas
- FR Barbecue au gaz
- PT Churrasqueira a gás
- IT Barbecue a gas
- BG Газов грил
- EL Σχάρα αερίου
- ZH 燃气烧烤炉



12+2.2 kW

4+1

SS
STAINLESS STEEL
STAL NERDZEWNA

360°

4x

4x
4x
BRAKE
HAMULEC



YATO	(kW)	(mm)	GRATE (mm)	LATTICE (mm)	(kg)
YG-20017	14.2	1410 x 550 x 1130	700 x 420	675 x 120	41.5

Gas-fired grill

- DE Gasgrill
- RU Газовый гриль
- UK Газовий гриль
- LT Dujinis grilis
- LV Gāzes grils
- CS Plynový gril
- SK Plynový gril
- HU Gázgrill
- RO Grătar cu gaz
- ES Barbacoa de gas
- FR Barbecue au gaz
- PT Churrasqueira a gás
- IT Barbecue a gas
- BG Газов грил
- EL Σχάρα αερίου
- ZH 燃气烧烤炉



18+2.2 kW

6+1

SS
STAINLESS STEEL
STAL NERDZEWNA

360°

4x

4x
4x
BRAKE
HAMULEC



YATO	(kW)	(mm)	GRATE (mm)	LATTICE (mm)	(kg)
YG-20017	20.2	1440 x 570 x 1130	780 x 420	790 x 120	39.5

Gas-fired grill 2 in 1

- DE Gasgrill
- RU Газовый гриль
- UK Газовий гриль
- LT Dujinis grilis
- LV Gāzes grils
- CS Plynový gril
- SK Plynový gril
- HU Gázgrill
- RO Grătar cu gaz
- ES Barbacoa de gas
- FR Barbecue au gaz
- PT Churrasqueira a gás
- IT Barbecue a gas
- BG Газов грил
- EL Σχάρα αερίου
- ZH 燃气烧烤炉

6+2.2 kW

2+1

SS
STAINLESS STEEL

360°

4x

4x
4x
BRAKE



YATO	(kW)	(mm)	GRATE (mm)	LATTICE (mm)	(kg)
YG-20030	8.2	1620 x 660 x 1130	900 x 420	900 x 120	54

Cast iron plate for gas grills

DE Gusseisenplatte für Gasgrills
RU Плита чугунная для газовых грилей
UK Чавунна пластина для газових грилів
LT Ketaus plokštė dujinėms kepsninėms
LV Čuguna plāksne gāzes restēm
CS Litinová deska pro plynové grily
SK Liatinová platňa pre plynové grily
HU Őntöttvas lemez gázcserzőkhöz
RO Placă de fontă pentru grătare pe gaz
ES Placa de hierro fundido para parrillas de gas
FR Plaque en fonte pour grils à gaz
PT Placa de ferro fundido para churrasqueiras a gás
IT Piastra in ghisa per grill a gas
BG Чугунена плоча за газова скара
EL Πλάκα από χυτοσίδηρο για γκριλ αερίου
ZH 燃气烧烤炉用铸铁板

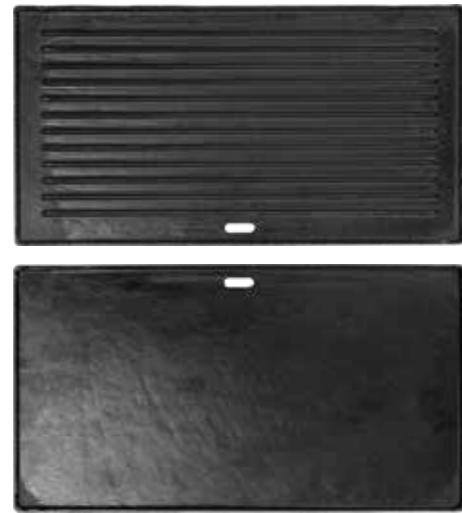

220x410 mm

CAST IRON
ZELIWO

2.7 kg

YATO	(mm)	FOR:
YG-20020	220 x 410	YG-20002, YG-20011, YG-20017, YG-20030

Automatic rotisserie for gas grill

DE - Automatischer Spieß für Gasgrill
RU - Автоматический вертел для газового гриля
UK - Автоматичний рожен для газового гриля
LT - Automatinis dujinis kepsninis iešmas
LV - Automātiskais iesms gāzes grilam
CS - Automatický rožeň k plynovému grilu
SK - Automatický ražeň na plynový gril
HU - Automatikus nyárs gázcserzőhez

RO - Rotisr automat pt. grătare pe gaz
ES - Espetón automático para parrilla de gas
FR - Rôtissoire automatique pour barbecue à gaz
PT - Espeto automático para churrasqueira a gás
IT - Girarosto automatico per barbecue a gas
BG - Автоматичен барбекю-шиш за газова скара
EL - Σούβλα με μοτέρ για ψησταριές υγραερίου
ZH - 烤炉配件

4W

SS
STAINLESS STEEL
STAL NERZEWNIA



YATO	BARBECUE (mm)	HANDLE (mm)	ENGINE (mm)	FOR:
YG-20021	825	110	70	YG-20001, YG-20012, YG-20013, YG-20014

Barbecue grill protective covers

DE Schutzhüllen für Gasgrills
RU Чехлы для барбекю
UK Чохли на грилі
LT Grilių dėklai
LV Griļu pārvalki
CS Kryty na grily
SK Kryty pre grily
HU Grill takaróponyva
RO Huse de protecție pentru grătare
ES Fundas para barbacoas
FR Housses pour barbecue
PT Capas para churrasqueiras
IT Copertura per barbecue
BG Калъфи за грилове
EL Καλύμματα για σχάρες
ZH 烧烤架防护罩



YATO	(mm)	FOR:
YG-20050	1300 x 600 x 1050	YG-20001, YG-20002, YG-20011
YG-20051	1500 x 650 x 1050	YG-20012, YG-20013, YG-20017, YG-20030

Single and dual deep fryers

DE Einzel- und Doppelfritteusen
RU Однoчные и двойные фритюрницы
UK Одиначні і подвійні фритюрниці
LT Pavienės ir dvigubos fritiūrinės
LV Fri katli vienkāršie un dubultie
CS Jednotlivé i dvojité fritězy
SK Jednoduché a dvojité fritězy
HU Szimpla és dupla olajsütők
RO Friteuze

ES Freidoras de cuba simple y doble
FR Friteuses à simple et double cuve
PT Fritadeiras simples e duplas
IT Friggitrice singole e doppie
BG Фритюрници единични и двойни
EL Μονές και διπλές φριτέζες
ZH 电炸炉

°C 60-200
SS STAINLESS STEEL
PC PANEL COVER
COLD AREA



Single deep fryers

YATO	(W)	MAX. (l)*	BASKET (mm)	(mm)	(kg)
YG-04608	2000	3.5	210 x 125 x 95	430 x 200 x 290	4.5
YG-04609	2000	5	210 x 125 x 135	430 x 200 x 335	5.5
YG-04610	3000	6	210 x 190 x 95	430 x 285 x 285	6
YG-04616	3300	8.5	210 x 190 x 150	430 x 285 x 335	6.5
YG-04617	5000	11	240 x 220 x 120	490 x 285 x 360	8



Dual deep fryers

- separate switches and thermostats for each of the two chambers

YATO	(W)	MAX. (l)*	BASKET (mm)	(mm)	(kg)
YG-04620	2 x 2000	2 x 3.5	215 x 120 x 95	425 x 410 x 290	9
YG-04621	2 x 2000	2 x 5	215 x 120 x 135	425 x 410 x 340	9.5
YG-04622	2 x 3000	2 x 6	215 x 195 x 95	425 x 580 x 305	10.5
YG-04623	2 x 3300	2 x 8	215 x 195 x 150	425 x 580 x 335	12
YG-04624	2 x 5000	2 x 11.5	240 x 220 x 110	490 x 595 x 360	15

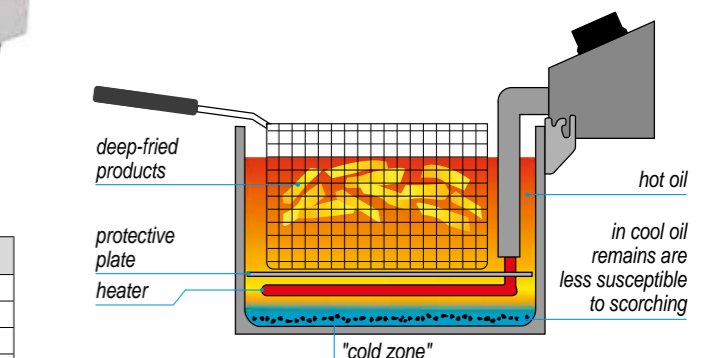

* total capacity

Deep fryers with a faucet

- | | |
|-----------------------------------|--------------------------------------|
| DE Fritteusen mit Hahn | RO Friteuze cu robinet de golire |
| RU Фритюрницы с краном | ES Freidoras con grifo de vaciado |
| UK Фритюрниця з краном | FR Friteuses avec robinet de vidange |
| LT Fritiūrinės su čiaupu | PT Fritadeiras com torneira |
| LV Fri katli ar krāniņu | IT Friggitrici con rubinetto |
| CS Fritézy s ventilem | BG Фритюрници с кран |
| SK Fritézy s ventilom | EL Φριτέζες με βρύση |
| HU Olajsütő olajleeresztő csappal | ZH 带龙头的电炸炉 |



Single deep fryers with a faucet

YATO	(W)	MAX. (l)*	BASKET (mm)	(mm)	(kg)
YG-04615	3000	6.5	210 x 190 x 90	530 x 300 x 355	7
YG-04630	5000	12	240 x 220 x 115	550 x 365 x 400	11



Dual deep fryers with a faucet

YATO	(W)	MAX. (l)*	BASKET (mm)	(mm)	(kg)
YG-04632	2 x 3000	2 x 6	210 x 190 x 90	520 x 610 x 355	14
YG-04634	2 x 5000	2 x 12	240 x 220 x 120	550 x 730 x 400	18

* total capacity

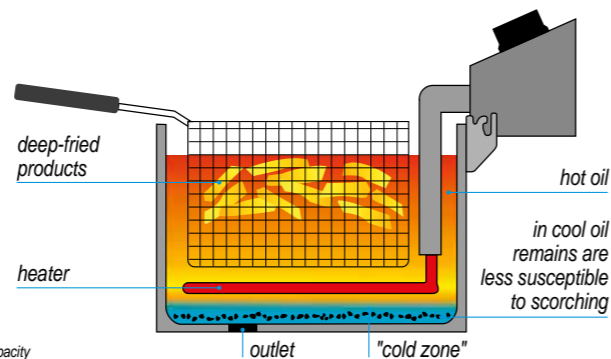

- 60-200 °C
- SS**
STAINLESS STEEL
- PC**
PANEL COVER
- COLD AREA**
- DRAINING TAP**



YG-04630 YG-04615
YG-04634 YG-04632



Freestanding deep fryers

- | | |
|-----------------------------------|-----------------------------------|
| DE Freistehende Fritteusen | RO Friteuze adânci |
| RU Автономные фритюрницы | ES Freidoras independientes |
| UK Автономні фритюрниця | FR Friteuses indépendantes |
| LT Laisvai pastatomos fritiūrinės | PT Fritadeiras com pés |
| LV Brīvi stāvoši fri katli | IT Friggitrici autoportanti |
| CS Volně stojící fritéza | BG Свободно стоящи фритюрници |
| SK Stojanové fritézy | EL Φριτέζες ελεύθερης τοποθέτησης |
| HU Szabadon álló olajsütő | ZH 立式电炸炉 |

- 60-200 °C
- SS**
STAINLESS STEEL
- PC**
PANEL COVER
- COLD AREA**
- DRAINING TAP**

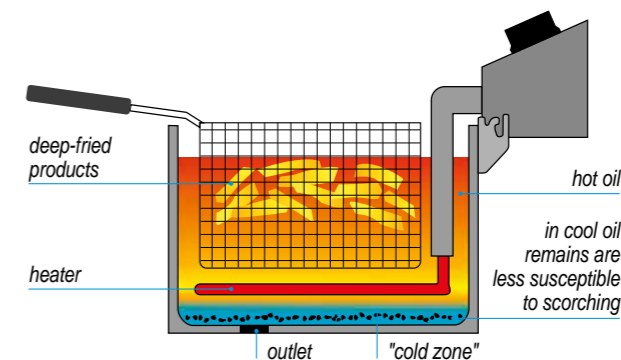

YG-04636



YG-04638

YATO	(W)	MAX. (l)*	BASKET (mm)	CABINET (mm)	(mm)	(kg)
YG-04636	5000	11.5	240 x 225 x 115	315 x 370 x 390	520 x 365 x 935	16
YG-04638	2 x 5000	2 x 11.5	240 x 225 x 115	680 x 370 x 390	520 x 730 x 900	31

* total capacity

Frying machines

- DE Multibräter
- RU Жарительницы
- UK Жаровня
- LT Gruzdintuvės
- LV Cepēji
- CS Smažicí stroje
- SK Zariadenia na vysmážanie
- HU Olajsütők
- RO Maşini de prăjit
- ES Freidoras
- FR Friteuses
- PT Fritadeiras
- IT Friggitrici
- BG Специални фритюрници
- EL Ανατρελόµενα τηγάνια
- ZH 电炸炉

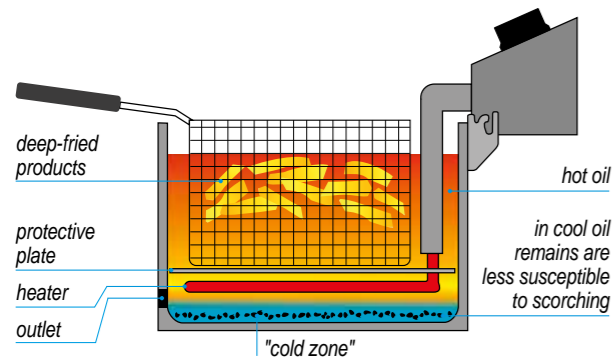
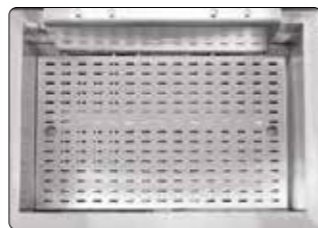
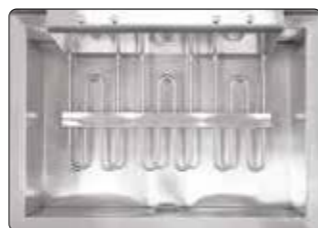

YATO	(W)	MAX. (l)*	BASKET (mm)	(mm)	(kg)
YG-04640	6000	23	270 x 480 x 90	570 x 580 x 340	14
YG-04641	6000	26.5	270 x 480 x 90	600 x 600 x 360	15

* total capacity

Circulator for sous vide cooking

- DE Zirkulator zum Sous-Vide-Kochen
- RU Циркулятор для вакуумного приготовления
- UK Циркулятор для приготування їжі sous vide
- LT Sous vide virimo cirkulatorius
- LV Sous vide cirkulators
- CS Cirkulátor pro vakuované vaření
- SK Cirkulačný prístroj na varenie sous vide
- HU Sous-Vide keringető
- RO Aparat pentru gătit sous vide
- ES Circulador de inmersión sous vide
- FR Circulateur d'immersion de précision pour cuisson sous vide
- PT Circulador para cozimento a vácuo
- IT Circolatore per la cottura sous vide
- BG Циркулятор за sous vide готвене
- EL Κυκλοφορητής για sous vide μαγειρική
- ZH 真空低温烹饪器



YATO	(W)	(l)	(mm)	(kg)
YG-04730	1500	<30	28.5 x 18.2 x 14.5	2

Insulating spheres for sous vide cooking

- DE Isolierkugeln zum Sous-Vide-Kochen
- RU Изоляционные шарики для вакуумного приготовления
- UK Ізоляційні кульки для приготування їжі sous vide
- LT Sous vide izoliaciniai virimo rutuliukai
- LV Izolācijas lodītes sous vide gatavošanai
- CS Izolační kuličky pro vakuované vaření
- SK Izolačné guľôčky na varenie sous vide
- HU Szigetelő golyók Sous-Vide keringetőhöz
- RO Bile izolante pentru gătit sous vide
- ES Pelotas para cocina sous vide
- FR Billes isolantes pour cuisson sous vide

- PT Bolas de isolamento para cozimento a vácuo
- IT Palline isolanti per la cottura sous vide
- BG Изолационни топки за sous vide готвене
- EL Μπάλες μόνωσης για sous vide μαγειρική
- ZH 真空绝缘球



YATO	(pcs.)	Ø (mm)	MAX. TEMPERATURE (°C)
YG-04735	100	20	110

- 1500W
- °C 5-99
- 0.1°C TEMP. ADJUSTMENT
- +/-0.5°C TEMP. TOLERANCE
- 0~99 h TIME SETTING
- <30L MAX CAPACITY
- WATER CIRCULATION
- MEMORY
- LCD DISPLAY
- SS STAINLESS STEEL

Pancake maker

DE Срепесмакер
RU Блинная
UK Млинниця
LT Lietinių gaminimo aparatas
LV Pankūku cepšanas iekārta
CS Palačinkovač
SK Stroj na smaženie palacinek
HU Palacsinta készítő
RO Plită pentru clătite
ES Срепера
FR Crêpière
PT Panquequeira
IT Macchina per pancake
BG Уред за палачинки
EL Τηγάνι για κρέπες
ZH 煎饼机



Ø 400 mm PTFE 50-300 °C WORKING TEMPERATURE 3000W SS STAINLESS STEEL



YATO	(W)	(mm)	PLATE (mm)	(kg)
YG-04680	3000	450 x 470 x 220	Ø 400 x 15	13

Rice cookers

DE Reiskocher
RU Рисоварки
UK Пристрої для приготування рису
LT Ryžių virimo įrenginys
LV Rīsu vāritāji
CS Zařízení k vaření rýže
SK Zariadenia na varenie ryže
HU Rizsfőző készülék
RO Oală pentru gătit orezului
ES Aparatos para cocinar arroz
FR Cuiseurs à riz
PT Panelas de arroz
IT Macchina per la cottura del riso
BG Уред за варене на ориз
EL Συσκευές για μαγειρέμα ρυζιού
ZH 电饭煲



SS STAINLESS STEEL ABS ENERGY SAVING MODE COOKING WARMING DIODES NON STICK POT



YG-04695

- container capacity: 16.5 l
- maximum amount of dry rice: 5.5 l (30 servings of 180 ml)
- internal dimensions of the container: Ø 320 x 210 mm

YATO	V (l)	(mm)	(W)
YG-04695	16.5	480 x 380 x 380	1950
YG-04696	27	560 x 490 x 405	2850

YG-04696

- container capacity: 27 l
- maximum amount of dry rice: 9 l (50 servings of 180 ml)
- internal dimensions of the container: Ø 380 x 240 mm



Steel food transport containers

DE Transport-Thermobehälter aus Stahl
RU Термосы для транспортировки
UK Сталеві транспортні термоси
LT Plieniniai transportavimo termosai
LV Transportēšanas termosī, tērauda
CS Přepavní stylové termosky
SK Prepravné ocelové termosky
HU Acél szállítótermoszok
RO Container etanș pentru transport
ES Contenedores isotérmicos de acero
FR Récipients isothermes en acier
PT Garrafas térmicas de aço para transporte
IT Thermos da trasporto in acciaio
BG Стоманени термоси за транспортиране
EL Θερμομονωτικές φιάλες μεταφοράς από ανοξείδωτο χάλυβα
ZH 保温桶



SS443/201 STAINLESS STEEL THERMAL ISOLATION 80-68 °C 0-6 °C 8h

DECOMPRESSION VALVE SILICONE GASKET RUBBER BOTTOM PAD

x2 HANDLES x6 CLIPS DOUBLE WALL

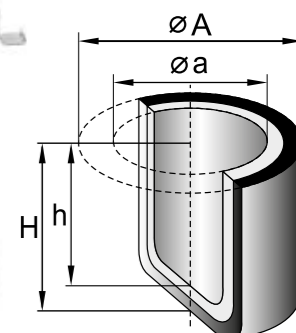

YATO	V (l)	Ø A (mm)	Ø a (mm)	H (mm)	h (mm)
YG-09200	10	355	300	240	165
YG-09201	15	355	300	300	210
YG-09202	20	355	300	380	300

YATO	V (l)	Ø A (mm)	Ø a (mm)	H (mm)	h (mm)
YG-09203	25	355	300	450	375
YG-09204	35	355	300	590	510
YG-09205	50	505	450	390	320

Thermally insulated food transport containers

DE Thermobehälter für den Transport von Lebensmitteln
RU Термосы для транспортировки пищи
UK Термос для транспортування їжі
LT Maisto transportavimo termosai
LV Pārtikas transportēšanas termosī
CS Termosky k přepravě potravin
SK Prepravné termosky pre potraviny
HU Ételszállító termoszok
RO Vas izoterm pentru transportul alimentelor
ES Contenedores isotérmicos transporte de alimentos
FR Conteneurs isothermes pour le transport d'aliment
PT Garrafas térmicas para transporte de alimentos

IT Thermos per il trasporto di alimenti
BG Термоси за транспортиране на храна
EL Θερμομονωτικές φιάλες για μεταφορά τροφίμων
ZH 保温桶

SS STAINLESS STEEL PE DECOMPRESSION VALVE

SILICONE GASKET THERMAL ISOLATION 85-80 °C -3-0 °C 4h

x2 HANDLES x4 CLIPS

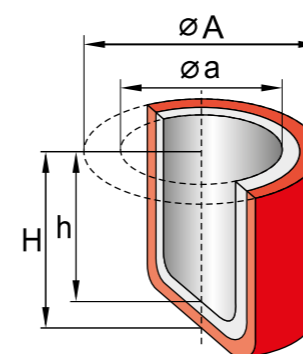

YATO	V (l)	Ø A (mm)	Ø a (mm)	H (mm)	h (mm)
YG-09225	15	335	280	300	240
YG-09226	30	410	350	380	320
YG-09227	48	465	405	445	380

Thermally insulated catering container GN 1/1

DE Thermoisolierte Cateringbehälter GN 1/1
RU Контейнер с термоизоляцией GN 1/1
UK Кейтеринговий теплоізоляційний контейнер GN 1/1
LT Termoizoliacinis maisto pervežimo konteineris GN 1/1
LV Kateringa termoss GN 1/1
CS Cateringová termoizolační nádoba GN 1/1
SK Termoizolačná cateringová nádoba GN 1/1
HU GN 1/1 thermo láda
RO Recipient termoizolant GN 1/1

ES Contenedores isotérmicos de hostelería GN 1/1
FR Récipient isotherme pour la restauration GN 1/1
PT Recipiente isolado para restauração GN 1/1
IT Contenitore termoisolante per il catering GN 1/1
BG Изотермичен контейнер GN 1/1
EL Δοχείο θερμομόνωσης GN 1/1 για κέττερινγκ
ZH 保温桶

GN 1/1 **PE** **x4 CLIPS**

85-80°C
-3-0°C
4h

THERMAL ISOLATION



YATO	V (l)	(mm)	INTERIOR (mm)
YG-09250	30	610 x 410 x 310	510 x 300 x 200

Thermally insulated catering container GN 1/1

DE Thermoisolierte Cateringbehälter GN 1/1
RU Контейнер с термоизоляцией GN 1/1
UK Кейтеринговий теплоізоляційний контейнер GN 1/1
LT Termoizoliacinis maisto pervežimo konteineris GN 1/1
LV Kateringa termoss GN 1/1
CS Cateringová termoizolační nádoba GN 1/1
SK Termoizolačná cateringová nádoba GN 1/1
HU GN 1/1 thermo láda
RO Recipient termoizolant GN 1/1
ES Contenedores isotérmicos de hostelería GN 1/1
FR Récipient isotherme pour la restauration GN 1/1
PT Recipiente isolado para restauração GN 1/1
IT Contenitore termoisolante per il catering GN 1/1

BG Изотермичен контейнер GN 1/1
EL Δοχείο θερμομόνωσης GN 1/1 για κέττερινγκ
ZH 保温桶



GN 1/1 **40L** **30mm WALL THICKNESS**

THERMAL ISOLATION

PIOCELAN **LID**



YATO	V (l)	(mm)	INTERIOR (mm)
YG-09210	40	600 x 400 x 283	540 x 340 x 222

Thermally insulated catering cabinet

DE Thermoisolierte Cateringbehälter
RU Термоконтейнер для перевозки
UK Кейтеринговий теплоізоляційний контейнер
LT Termoizoliacinis maisto pervežimo konteineris
LV Kateringa termoss
CS Cateringová termoizolační nádoba
SK Termoizolačná cateringová nádoba
HU Thermo láda
RO Container termoizolant pentru transport
ES Contenedores isotérmicos para restaurantes
FR Récipients isothermes pour la restauration
PT Recipiente isolado para restauração
IT Contenitore termoisolante per il catering
BG Изотермичен контейнер за кетъринг

EL Δοχείο θερμομόνωσης για κέττερινγκ
ZH 保温餐饮柜

90L **PE** **1/1 GN** **1/2 GN** **1/3 GN**

x6 (65mm)
x4 (100mm)
x3 (150mm)

x8 (100mm)
x4 (150mm)

x12 (100mm)
x9 (150mm)
x6 (200mm)

80-68°C
0-6°C
4h

THERMAL ISOLATION

x2 HANDLES **DECOMPRESSION VALVE**



YATO	(mm)
YG-09245	477 x 680 x 620

• equipped with 12 guides that make it match the following GN containers:

- 1/1, 65 mm high – 6 pcs.
- 1/1, 100 mm high – 4 pcs.
- 1/1, 150 mm high – 3 pcs.
- 1/2, 100 mm high – 8 pcs.
- 1/2, 150 mm high – 4 pcs.
- 1/3, 100 mm high – 12 pcs.
- 1/3, 150 mm high – 9 pcs.
- 1/3, 200 mm high – 6 pcs.

Cart for thermally insulated cabinet

DE Wagen für thermoisolierte Behälter
RU Подставка для термоконтейнера на колесах
UK Візок для термоізоляційного контейнера
LT Termoizoliacinio konteinerio vežimėlis
LV Ratiņi kateringa termosam
CS Vozík na termoizolační nádobu
SK Vozík pre termoizolačné nádoby
HU Thermo láda szállító kocsi
RO Platformă cu roți
ES Carro portacontenedores isotérmicos
FR Chariot pour conteneurs isothermes
PT Carrinho para recipientes térmicos

IT Carrello per il contenitore termoisolante
BG Количка за изотермичен контейнер
EL Καροτσάκι για δοχεία θερμομόνωσης
ZH 保温柜推车

PP **x2 YG-09245 MAX LOAD** **360° 2x** **FOR: YG-09245**



YATO	(mm)	FOR:
YG-09246	710 x 530 x 230	YG-09245

Thermally insulated beverage dispenser

DE Thermoisolierte Transportbehälter
RU Термоконтейнеры для транспортировки
UK Транспортні термоізоляційні ємності
LT Termoizoliaciniai maisto transportavimo konteineriai
LV Transportēšanas termosi
CS Přepravní termoizolační nádoby
SK Prepravné termoizolačné nádoby
HU Thermo szállító ládák
RO Containere termoizolante pentru băuturi
ES Contenedores isotérmicos de transporte
FR Conteneurs isothermes de transport
PT Recipientes térmicos para transporte
IT Contenitori da trasporto termoisolanti
BG Изотермични контейнери за транспортиране
EL Δοχείο θερμομόνωσης μεταφοράς
ZH 饮料保温分配器

x2 HANDLES **80-72°C** **0-4°C** **4h** **THERMAL ISOLATION** **PE**



YATO	V (l)	(mm)	INTERIOR (mm)
YG-09249	9	430 x 230 x 470	330 x 175 x 265

Waiter trolleys

DE Kellnerwagen
RU Тележки для официантов
UK Візки для офіціантів
LT Padavėjo vežimėlis
LV Viesmīļu ratiņi
CS Číšnícké vozíky
SK Čašnické vozíky
HU Pincérkocsik
RO Cărucioare pentru servire
ES Carros de camarero
FR Table roulante
PT Carrinhos de garçom
IT Carrelli per camerieri

BG Ресторантски колички за сервиране
EL Καροτσάκια σερβιτόρων
ZH 服务车

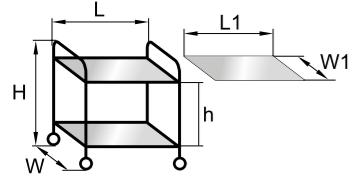

x2
SHELVES

Two-shelf waiter trolley

YATO 	L x W x H (mm)	L1 x W1 (mm)	h (mm)
YG-09090	860 x 530 x 950	820 x 500	570

x3
SHELVES

Three-shelf waiter trolley

YATO 	L x W x H (mm)	L1 x W1 (mm)	h (mm)
YG-09091	860 x 530 x 950	820 x 500	270

Waiter trolleys

DE Servierwagen
RU Сервировочные тележки
UK Сервісні візки
LT Serviravimo vežimėliai
LV Servēšanas ratiņi
CS Servisní vozíky
SK Vozíky na servírovanie
HU Felszolgáló kocsik
RO Cărucioare din oțel inoxidabil
ES Carros de servicio
FR Chariots de service
PT Carrinhos de serviço
IT Carrelli di servizio
BG Ресторантски колички за съдове
EL Καροτσάκια σέρβις
ZH 服务车

x2
SHELVES

Two-shelf waiter trolley

YATO 	L x W x H (mm)	L1 x W1 (mm)	h (mm)
YG-09095	950 x 500 x 950	890 x 495	600

x3
SHELVES

Three-shelf waiter trolley

YATO 	L x W x H (mm)	L1 x W1 (mm)	h (mm)
YG-09096	950 x 500 x 950	890 x 495	280

x2
SHELVES

Deep two-shelf waiter trolley

YATO 	L x W x H (mm)	L1 x W1 (mm)	h (mm)
YG-09099	950 x 500 x 950	820 x 430	500

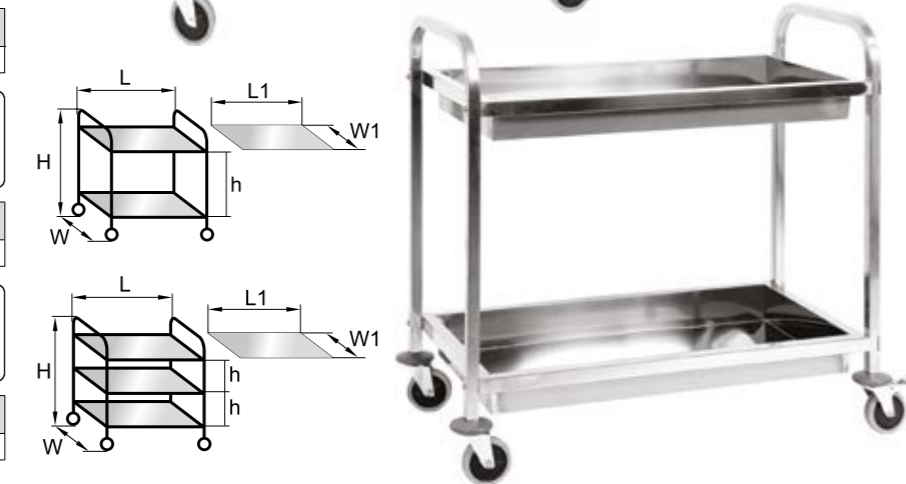
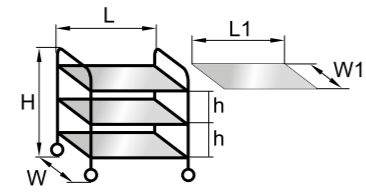
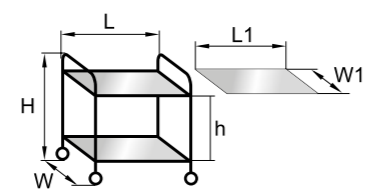

Service trolley

DE Servierwagen
RU Сервисная тележка
UK Сервісний візок
LT Serviravimo vežimėlis
LV Servēšanas ratiņi
CS Servisní vozík
SK Vozík na servírovanie
HU Felszolgáló kocsi
RO Cărucior pentru debarasat cu trei polițe
ES Carro de servicio
FR Chariot de service
PT Carrinho de serviço
IT Carrello di servizio
BG Ресторантска количка за съдове
EL Καροτσάκι σέρβις
ZH 服务车

YATO 	(mm)
YG-09100	1040 x 510 x 980

Containers for service trolley

DE Behälter für Servierwagen
RU Контейнеры для сервисной тележки
UK Контейнери для сервісного візка
LT Serviravimo vežimėlio indai
LV Trauī servēšanas ratiņiem
CS Nádobys na servisní vozík
SK Nádobys pre vozík na servírovanie
HU Tartályok felszolgáló kocsihoz
RO Containere pentru cărucior de debarasare

YATO 	(mm)	FOR:
YG-09104	330 x 230 x 175	YG-09100
YG-09105	340 x 225 x 440	YG-09100

Service trolley

DE Servierwagen
RU Сервисная тележка
UK Сервісний візок
LT Serviravimo vežimėlis
LV Servēšanas ratiņi
CS Servisní vozík
SK Vozík na servírovanie
HU Felszolgáló kocsi
RO Cărucior pentru debarasat cu trei polițe
ES Carro de servicio
FR Chariot de service
PT Carrinho de serviço
IT Carrello di servizio
BG Ресторантска количка за съдове
EL Καροτσάκι σέρβις
ZH 服务车

YATO 	(mm)
YG-09101	870 x 435 x 905

Containers for service trolley

DE Behälter für Servierwagen
RU Контейнеры для сервисной тележки
UK Контейнери для сервісного візка
LT Serviravimo vežimėlio indai
LV Trauī servēšanas ratiņiem
CS Nádobys na servisní vozík
SK Nádobys pre vozík na servírovanie
HU Tartályok felszolgáló kocsihoz

YATO 	(mm)	INTERIOR (mm)	FOR:
YG-09102	540 x 380 x 135	460 x 330 x 130	YG-09101
YG-09103	540 x 380 x 205	460 x 330 x 200	YG-09101
YG-09106	275 x 195 x 310	265 x 185 x 305	YG-09101



PE **x3** SHELVES **2x** BRAKE

360° **2x** 



ES Recipientes para carro de servicio
FR Conteneurs pour chariot de service
PT Recipientes para carrinho de serviço
IT Contenitori per il carrello di servizio
BG Контейнери за ресторантска количка
EL Δοχείο για καροτσάκια σέρβις
ZH 服务车收集盒



PP



SS STAINLESS STEEL **PP** **x5** CONTAINERS

2x BRAKE **360°** **2x** 



RO Containere pentru cărucior de debarasare
ES Recipientes para carro de servicio
FR Conteneurs pour chariot de service
PT Recipientes para carrinho de serviço
IT Contenitori per il carrello di servizio
BG Контейнери за ресторантска количка
EL Δοχείο για καροτσάκια σέρβις
ZH 服务车收集盒



PP

Transport trolleys

- | | |
|---|----------------------------|
| DE Transportwagen | ES Carro de transporte |
| RU Тележки-шпильки | FR Chariot de transport |
| UK Транспортні візки | IT Carrelli da trasporto |
| LT Transportavimo vežimėliai | BG Транспортни колички |
| LV Transportēšanas ratiņi | EL Καροτσάκια μεταφοράς |
| CS Převážní vozíky | PT Carrinhos de transporte |
| SK Prepravné vozíky | ZH 手推车 |
| HU Tálcaszállító kocsik | |
| RO Cărucioare pentru transportul tăvilor și GN-urilor | |

SS 201 STAINLESS STEEL	max 40kg SHELF	80 mm	2x BRAKE	TRANSPORT LOCK	
----------------------------------	-----------------------------	----------	--------------------	-------------------	--





15x
1/1GN

30x
1/2GN

Guides M



The guides enables adjusting the spacing between containers



Guides L



Gastronomic trolley for waiter's trays and baking trays

Transport trolley for GN containers

YATO [®]	(mm)
YG-09070	380 x 550 x 1700

YATO [®]	(mm)
YG-09072	470 x 620 x 1700

Platform trolley

- | | |
|---------------------------|---------------------------|
| DE Plattformwagen | ES Carro de plataforma |
| RU Платформенная тележка | FR Chariot à plate-forme |
| UK Платформний візок | PT Carrinho de plataforma |
| LT Platforminis vežimėlis | IT Carrello a pianale |
| LV Platformas ratiņi | BG Платформена количка |
| CS Platformový vozík | EL Καροτσάκι πλατφόρμας |
| SK Plošinový vozík | ZH 折叠手推车 |
| HU Platform kocsik | |
| RO Cărucior platformă | |

SS 201 STAINLESS STEEL
max 150kg
360° 2x
FOLDABLE HANDLE

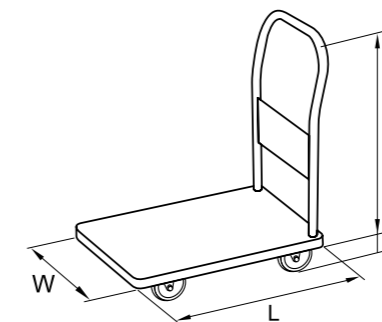

YATO [®]	L x W (mm)	H (mm)	h (mm)
YG-09080	740 x 440	725	125

Assemblable work tables

DE Arbeitstische – zusammengeschaubt
RU Столы рабочие – сборные
UK Болтові робочі столи
LT Susukami darbataliai
LV Darba galdi, saskrūvējami
CS Pracovní montované stoly
SK Pracovné stoly skladacie
HU Csavarozott munkasztalok
RO Mese de lucru
ES Mesa de trabajo para cocina profesional
FR Table avec un plan de travail pour cuisine
PT Mesas de trabalho montadas
IT Banchi da lavoro avvitati
BG Сглобяеми работни маси
EL Περιτρεφόμενα τραπέζια εργασίας
ZH 不锈钢工作台

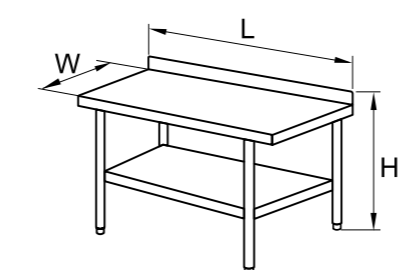
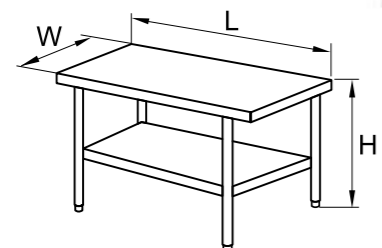

Central tables with undershelf

YATO 	L (mm)	W (mm)	H (mm)
YG-09000	800	600	850
YG-09001	1000	600	850
YG-09002	1200	600	850
YG-09003	1400	600	850
YG-09004	1500	600	850
YG-09005	1600	600	850
YG-09006	800	700	850
YG-09010	1000	700	850
YG-09011	1200	700	850
YG-09012	1400	700	850
YG-09013	1500	700	850
YG-09014	1600	700	850

Wall tables with undershelf - with a 100 mm back splash

YATO 	L (mm)	W (mm)	H (mm)
YG-09020	800	600	850+100
YG-09021	1000	600	850+100
YG-09022	1200	600	850+100
YG-09023	1400	600	850+100
YG-09024	1500	600	850+100
YG-09025	1600	600	850+100
YG-09030	800	700	850+100
YG-09031	1000	700	850+100
YG-09032	1200	700	850+100
YG-09033	1400	700	850+100
YG-09034	1500	700	850+100
YG-09035	1600	700	850+100

SS 201
STAINLESS STEEL

max **150 kg**
TABLE

max **35 kg**
SHELF

ADJUSTABLE FEET

DETERGENT



Slatted racks

DE Lagerregale
RU Сетчатые стеллажи
UK Ажурні стелажі
LT Azūriniai stelažai
LV Azūra plauktu stelāžas

CS Transparentní regály
SK Dierované regály
HU Állványos polc rendszer
RO Rafturi tip plasă
ES Estanterías con baldas

FR Étagères ajourées
PT Prateleiras vazadas
IT Scaffalature traforate
BG Ажурни рафтове

EL Διάφανα ράφια
ZH 置物架

Cr
CHROME PLATED

Shelves

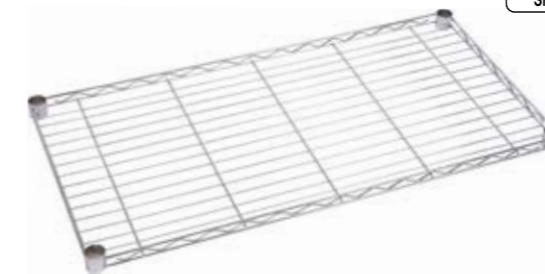

max **200 kg**
SHELF

8+2
FIXING
WEDGES

YATO 	(mm)	CONFIGURATIONS OF ASSEMBLED RACK	(mm)
YG-09050	600 x 457	4 x YG-09050 + 4 x YG-09065	600 x 457 x 1880
YG-09051	906 x 457	4 x YG-09051 + 4 x YG-09065	906 x 457 x 1880
YG-09052	1210 x 457	4 x YG-09052 + 4 x YG-09065	1210 x 457 x 1880
YG-09053	1520 x 457	4 x YG-09053 + 4 x YG-09065	1520 x 457 x 1880
YG-09054	600 x 610	4 x YG-09054 + 4 x YG-09065	600 x 610 x 1880
YG-09055	906 x 610	4 x YG-09055 + 4 x YG-09065	906 x 610 x 1880
YG-09056	1060 x 610	4 x YG-09056 + 4 x YG-09065	1060 x 610 x 1880
YG-09057	1210 x 610	4 x YG-09057 + 4 x YG-09065	1210 x 610 x 1880
YG-09058	1520 x 610	4 x YG-09058 + 4 x YG-09065	1520 x 610 x 1880
YG-09059	1820 x 610	4 x YG-09059 + 4 x YG-09065	1820 x 610 x 1880

Bars

1880 mm

RUBBER FOOT

FOR:
YG-09050, YG-09051
YG-09052, YG-09053
YG-09054, YG-09055
YG-09056, YG-09057
YG-09058, YG-09059

YATO 	L (mm)	∅ (mm)
YG-09065	1880	25.4

Hanging shelves with rim

DE Hängeregale mit Rand
RU Навесные полки с бортиком
UK Навісні полиці з бортиками
LT Kabančios lentynos su kraštu
LV Piekaramie plaukti ar apmali
CS Visací police se záhybem
SK Závesné police s okrajom
HU Fügő polcok peremmel
RO Polița de perete cu bordură
ES Repisas flotantes con borde elevado
FR Étagères murales avec bord surélevé
PT Prateleiras suspensas com borda
IT Mensole sospese con bordo
BG Стенни рафтове с кант
EL Κρεμαστά ράφια με άκρες
ZH 不锈钢挂墙架

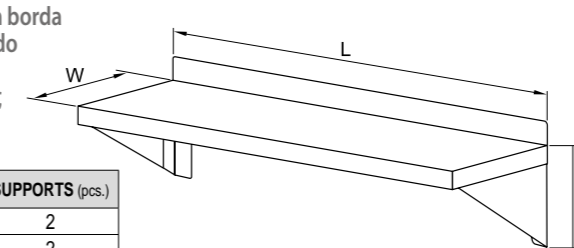

YATO 	L x W x H (mm)	SUPPORTS (pcs.)
YG-09040	900 x 300 x 180	2
YG-09041	1200 x 300 x 180	2
YG-09042	1500 x 300 x 180	3
YG-09044	1800 x 300 x 180	3



Vacuum packaging machine

DE Vakuumband-Verpackungsmaschine
RU Вакуумная упаковочная машина
UK Вакуумна пакувальна машина
LT Vakuuminio pakavimo mašina
LV Vakuuma iepakojanas mašina
CS Lištové vakuovací stroj
SK Vákuový baliaci stroj
HU Vákuumsomagoló gép
RO Mașină de ambalat sub vid
ES Máquina de envasado al vacío
FR Machine d'emballage sous vide
PT Embaladora a vácuo
IT Macchina confezionatrice sottovuoto
BG Вакуумна опаковъчна машина
EL Μηχανή συσκευασίας κενού
ZH 真空封口机

700W	MAX 320mm SEALING BAR	5.0 mm SEAL WIRE WIDTH	SS STAINLESS STEEL
DUAL PUMP	PULS VACUUM	IMPULS BAG SEALING	MARINATE



YATO	(W)	(mm)	BAR (mm)	(m ³ /h)
YG-09315	700	390 x 275 x 135	320	1

Chamber packaging machine

DE Vakuumkammer-Verpackungsmaschine
RU Камерная вакуумная упаковочная машина
UK Камерна вакуумна пакувальна машина
LT Kamerinis vakuuminio pakavimo aparatas
LV Kameras vakuuma iepakotājs
CS Komorový vakuovací stroj
SK Komorový vákuový baliaci stroj
HU Kamrás vákuumsomagoló gép
RO Masina de ambalat in vid cu camera
ES Envasadora al vacío de campana
FR Machine d'emballage sous vide à chambre profonde
PT Embaladora de câmara a vácuo
IT Confezionatrice sottovuoto a camere
BG Вакуум опаковъчна машина, камерна
EL Κοιλιακό μηχάνημα συσκευασίας κενού
ZH 真空封口机

630W	MAX 300mm SEALING BAR	3.5 mm SEAL WIRE WIDTH	110/60 mm	SS STAINLESS STEEL
-------------	---------------------------------	----------------------------------	------------------	------------------------------



YATO	(W)	(mm)	CHAMBER (mm)	BAR (mm)	(m ³ /h)	(kg)
YG-09317	630	430 x 360 x 345	350 x 300 x 110	300	4.6	24.4

Vacuum packaging machines

- DE Vakuum-Verpackungsmaschinen
- RU Машины вакуумной упаковки
- UK Вакуумні пакувальні машини
- LT Vakuuminio pakavimo aparatas
- LV Vakuuma iepakotāji
- CS Vakuovací stroje
- SK Vákuové baliace stroje
- HU Vákuumsomagoló gépek
- RO Maşini de ambalare în vid
- ES Envasadoras al vacío
- FR Machines d'emballage sous vide
- PT Embaladoras a vácuo
- IT Macchine confezionatrici sottovuoto
- BG Вакуум опаковъчни машини
- EL Μηχανήματα συσκευασίας κενού
- ZH 真空封口机



Adjustable packaging machines

YATO 	(mm)	CHAMBER (mm)	BAR (mm)	V (l)	(W)	(m ³ /h)
YG-09303	480 x 330 x 320h	385 x 280 x 50 (100)	260	230	370	10
YG-09304	480 x 370 x 435h	370 x 320 x 135 (185)	300	230	370	10
YG-09305	560 x 425 x 460h	450 x 370 x 170 (220)	350	230	900	20



Free-standing packaging machines

- equipped with 4 wheels with brakes



YATO 	(mm)	CHAMBER (mm)	BAR (mm)	V (l)	(W)	(m ³ /h)
YG-09310	555 x 475 x 1000h	440 x 420 x 75 (125)	2 x 420	230	900	20
YG-09311	555 x 475 x 1050h	440 x 420 x 150 (200)	400	230	900	20
YG-09312	630 x 790 x 960h	720 x 480 x 150 (210)	2 x 460	230	900	20



Bags for vacuum packaging machines

- DE Beutel für Vakuum-Verpackungsmaschinen
- RU Пакеты для вакуумных упаковочных машин
- UK Мішки для вакуумної упаковки
- LT Maišeliai vakuuminiam pakavimo aparatui
- LV Maisiņi vakuuma iepakotājiem
- CS Pytlíky do vakuovacích strojů
- SK Vrecká pre vákuové baliace stroje
- HU Tasakok vákuumsomagoló géphez
- RO Pungi pentru maşinile de ambalare în vid
- ES Bolsas para envasadoras al vacío
- FR Sacs pour machines d'emballage sous vide
- PT Sacos para embaladoras a vácuo
- IT Sacchetti per macchine confezionatrici sottovuoto
- BG Пликове за вакуум машини
- EL Σάκοι για μηχανήματα συσκευασίας κενού
- ZH 真空包装袋

x100 70 µm



Bags for chamber packaging machines

PA/PE

Bags for sous vide and chamber packaging machines

PA/PE SV 120°C (max)

- Recommended for preparing dishes in sous vide technology, marinating and pasteurizing.
- they can be used at temperature from -20°C to +120°C

YATO 	(mm)
YG-09330	140 x 200
YG-09331	160 x 230
YG-09332	200 x 300
YG-09333	250 x 350
YG-09334	300 x 400

YATO 	(mm)
YG-09335	140 x 200
YG-09336	160 x 230
YG-09337	200 x 300
YG-09338	250 x 350
YG-09339	300 x 400

Industrial vacuum packaging machine

DE Industrie-Vakuum-Verpackungsmaschine
RU Промышленная машина вакуумной упаковки
UK Промислова вакуумна пакувальна машина
LT Pramoninis vakuuminio pakavimo aparatas
LV Rūpnieciskais vakuuma iepakotājs
CS Průmyslový vakuovací stroj
SK Priemyselný vákuový baliaci stroj
HU Ipari vákuumsomagoló gép
RO Mașină de ambalare în vid industrială
ES Envasadoras al vacío industrial
FR Machines d'emballage sous vide industrielles
PT Embaladora a vácuo industrial
IT Macchina confezionatrice sottovuoto industriale
BG Индустриална вакуум опаковъчна машина
EL Βιομηχανικό μηχάνημα συσκευασίας κενού
ZH 工业真空封口机



SS
STAINLESS STEEL

2x
720x560
mm
CHAMBER

160
mm

2x20
m³/h
PUMP EFFICIENCY

2x900W



YATO 	(mm)	CHAMBER (mm)	BAR (mm)	V (l)	(W)	(m ³ /h)
YG-09307	720 x 1460 x 980h	720 x 560 x 160	2 x 600	480	2 x 900	2 x 20

Cooling and freezing cabinets

DE Kühl- und Gefrierschränke
RU Холодильные и морозильные шкафы
UK Холодильні та морозильні шафи
LT Vėsinimo ir šaldymo spintos
LV Aukstuma skapji
CS Chladicí a mrazicí boxy
SK Chladné a mraziace skrine
HU Hűtő- és fagyasztószelekre nyitók
RO Dulapuri de răcire și congelare
ES Armarios refrigerados y de congelación
FR Armoires réfrigérées et congélateurs
PT Armários de refrigeração e congelamento
IT Armadi frigoriferi e congelatori
BG Хладилни шкафовe и фризерни
EL Θάλαμοι ψύξης και κατάψυξης
ZH 冷藏柜



SS 201
STAINLESS STEEL

FORCED AIR CIRCULATION

AUTOMATIC DEFROST



max 40kg
SHELF

SELF CLOSING DOOR

LOCK

LED LIGHT

X4 †120-180
mm
ADJUSTABLE FEET

R290
REFRIGERANT

GN 2/1

HEPA FILTER



Cooling and freezing 1-door cabinets

• 3 coated shelves

YATO 	(°C)	V (l)	(mm)	(W)	(kg)	(kWh/year)*
YG-05215	-2/+8	600	680 x 810 x 2010	195	110	887
YG-05200	-2/+8	650	740 x 830 x 2010	215	121	1081
YG-05216	-18/-22	600	680 x 810 x 2010	450	117	2738
YG-05201	-18/-22	650	740 x 830 x 2010	480	126	2351



Cooling and freezing 2-door cabinets

• 6 coated shelves

YATO 	(°C)	V (l)	(mm)	(W)	(kg)	(kWh/year)*
YG-05220	-2/+8	1200	1340 x 810 x 2010	400	167	1716
YG-05210	-2/+8	1300	1480 x 830 x 2010	440	188	1517
YG-05221	-18/-22	1200	1340 x 810 x 2010	700	177	4238
YG-05211	-18/-22	1300	1480 x 830 x 2010	780	201	3650



* power consumption

Cooling tables – line 600

DE Kühlische – Linie 600
RU Холодильные столы – линия 600
UK Холодильні столи – лінія 600
LT Šaldomi darbastaliai – linija 600
LV Aukstuma galdi – sērija 600
CS Chladicí stoly – řada 600
SK Chladené stoly – linka 600
HU Hűtőasztalok – 600-as sorozat
RO Masă rece – linia 600
ES Mesas frigoríficas – serie 600
FR Tables de réfrigération – série 600
PT Mesas de refrigeração – linha 600
IT Tavoli refrigerati – linea 600
BG Хладилни маси – линия 600
EL Τραπεζία ψύξης – γραμμή 600
ZH 冷冻台-600 mm



Cooling 2-door table – line 600

- 2 coated shelves
- tabletop dimensions: 1360 x 600 mm
- adjusted height: 850-910 mm

YATO	(°C)	V (l)	(mm)	(W)	(kg)	(kWh/year)*
YG-05253	-2/+8	228	1360 x 600 x 850	215	83	913



Cooling 3-door table – line 600

- 3 coated shelves
- tabletop dimensions: 1795 x 600 mm
- adjusted height: 845-905 mm

YATO	(°C)	V (l)	(mm)	(W)	(kg)	(kWh/year)*
YG-05258	-2/+8	339	1795 x 600 x 845	230	105	1145

* power consumption

SS 201
STAINLESS STEEL

FORCED AIR CIRCULATION

AUTOMATIC DEFROST

max 40kg
SHELF

SELF CLOSING DOOR

X4 140-200mm
ADJUSTABLE FEET

R290
REFRIGERANT



Cooling tables – line 700

DE Kühlische – Linie 700
RU Холодильные столы – линия 700
UK Холодильні столи – лінія 700
LT Šaldomi darbastaliai – linija 700
LV Aukstuma galdi – sērija 700
CS Chladicí stoly – řada 700
SK Chladené stoly – linka 700
HU Hűtőasztalok – 700-as sorozat
RO Mesă rece – linia 700
ES Mesas frigoríficas – serie 700
FR Tables de réfrigération – série 700
PT Mesas de refrigeração – linha 700
IT Tavoli refrigerati – linea 700
BG Хладилни маси – линия 700
EL Τραπεζία ψύξης – γραμμή 700
ZH 冷冻台-700 mm



SS 201
STAINLESS STEEL

FORCED AIR CIRCULATION

AUTOMATIC DEFROST

max 40kg
SHELF

SELF CLOSING DOOR

GN 1/1

HEPA FILTER



Cooling 2-door table – line 700

- 2 coated shelves
- lower compressor – Zanussi
- cooling agent: R600a
- tabletop dimensions: 900 x 700 mm

R600a
REFRIGERANT

YATO	(°C)	V (l)	(mm)	(W)	(kg)	(kWh/year)*
YG-05270	+2/+8	240	900 x 700 x 870	170	75	830

SEE ALSO
shelves and guides

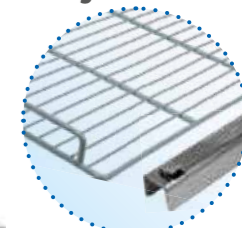

p. 87



Cooling 3-door table – line 700

- 3 coated shelves
- lower compressor – Embraco
- cooling agent: R290
- tabletop dimensions: 1365 x 700 mm

R290
REFRIGERANT

YATO	(°C)	V (l)	(mm)	(W)	(kg)	(kWh/year)*
YG-05300	+2/+8	368	1365 x 700 x 870	240	98	1294

* power consumption



Cooling table with 4 drawers – line 700

DE Kühlisch mit 4 Schubladen – Linie 700
 RU Холодильный стол с 4 выдвижными ящиками – линия 700
 UK Холодильний стіл з 4 ящиками – лінія 700
 LT Šaldomas darbastalis su 4 stalčiais – linija 700
 LV Aukstuma galds ar 4 atvilktnēm – sērija 700
 CS Chladicí stůl se 4 šuplíky – řada 700
 SK Chladený stôl s 4 zásuvkami – linka 700
 HU Hűtőasztal 4 fiókkal – 700-as sorozat
 RO Masă rece cu 4 sertare – linia 700
 ES Mesas frigoríficas con 4 cajones – serie 700
 FR Tables de réfrigération avec 4 tiroirs – série 700
 PT Mesa de refrigeração com 4 gavetas – linha 700
 IT Tavoli refrigerati con 4 cassetti – linea 700
 BG Хладилна маса с 4 чекмеджета – линия 700
 EL Τραπέζι ψύξης με 4 συρτάρια – γραμμή 700
 ZH 4抽屜冷凍台 – 700 mm



SS 201 STAINLESS STEEL	FORCED AIR CIRCULATION	AUTOMATIC DEFROST
x4 DRAWER	GN 1/1	R600a REFRIGERANT
		HEPA FILTER



YATO	(°C)	V (l)	(mm)	(W)	(kg)	(kWh/year)*
YG-05280	+2/+8	220	900 x 700 x 870	170	90	830

Cooling table with 6 drawers – line 700

DE Kühlisch mit 6 Schubladen – Linie 700
 RU Холодильный стол с 6 выдвижными ящиками – линия 700
 UK Холодильний стіл з 6 ящиками – лінія 700
 LT Šaldomas darbastalis su 6 stalčiais – linija 700
 LV Aukstuma galds ar 6 atvilktnēm – sērija 700
 CS Chladicí stůl se 6 šuplíky – řada 700
 SK Chladený stôl s 6 zásuvkami – linka 700
 HU Hűtőasztal 6 fiókkal – 700-as sorozat
 RO Masă rece cu 6 sertare – linia 700
 ES Mesas frigoríficas con 6 cajones – serie 700

FR Tables de réfrigération avec 6 tiroirs – série 700
 PT Mesa de refrigeração com 6 gavetas – linha 700
 IT Tavoli refrigerati con 6 cassetti – linea 700
 BG Хладилна маса с 6 чекмеджета – линия 700
 EL Τραπέζι ψύξης με 6 συρτάρια – γραμμή 700
 ZH 6抽屜冷凍台 – 700 mm



SS 201 STAINLESS STEEL	FORCED AIR CIRCULATION	AUTOMATIC DEFROST
x6 DRAWER	GN 1/1	R290 REFRIGERANT

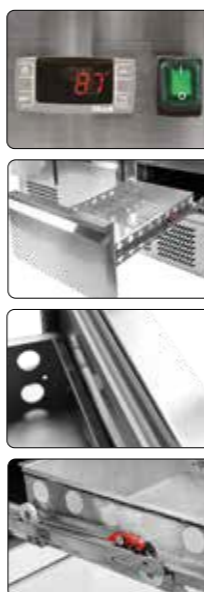

YATO	(°C)	V (l)	(mm)	(W)	(kg)	(kWh/year)*
YG-05281	+2/+8	368	1365 x 700 x 880	240	104	1294

* power consumption



Cooling and freezing tables with side compressor – line 700

DE Kühl- und Gefrierische mit Seitenaggregat – Linie 700
 RU Холодильные и морозильные столы с боковым агрегатом – линия 700
 UK Холодильні столи та морозильні камери з бічним агрегатом – лінія 700
 LT Šaldomi darbastaliai su šoniniu agregatu – linija 700
 LV Aukstuma galdi ar sānu agregātu – sērija 700
 CS Chladicí a mraziací stoly s bočním agregátem – řada 700
 SK Chladené a mraziace stoly s bočným agregátom – linka 700
 HU Hűtő- és fagyasztóasztalok oldalsó aggregátummal – 700-as sorozat
 RO Mese reci și de congelare cu compresor lateral – linia 700
 ES Mesas frigoríficas y de congelación con aislamiento lateral – serie 700
 FR Tables de réfrigération et congélateurs avec isolation latérale – série 700
 PT Mesas de refrigeração e congelamento com agregado lateral – linha 700
 IT Tavoli refrigerati e congelatori con aggregato laterale – linea 700
 BG Хладилни маси и фризер маси със страничен агрегат – линия 700
 EL Τραπέζι ψύξης και καταψύξεις με πλευρικό συσσωμάτωμα – γραμμή 700
 ZH 自帶側壓縮機制冷冷凍台 – 700 mm



SS 201 STAINLESS STEEL	FORCED AIR CIRCULATION
AUTOMATIC DEFROST	max 40kg SHELF
GN 1/1	SELF CLOSING DOOR
	x4 120-180 mm ADJUSTABLE FEET
R290 REFRIGERANT	HEPA FILTER



Cooling and freezing 2-door tables with side compressor – line 700

• 2 coated shelves

YATO	(°C)	V (l)	(mm)	(W)	(kg)	(kWh/year)*
YG-05250	-2/+8	282	1360 x 700 x 950	215	102	919
YG-05251	-18/-22	282	1360 x 700 x 950	520	110	2592



SEE ALSO
shelves and guides

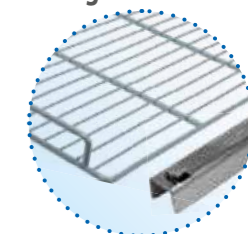

p. 87

Cooling and freezing 3-door tables with side compressor – line 700

• 3 coated shelves

YATO	(°C)	V (l)	(mm)	(W)	(kg)	(kWh/year)*
YG-05255	-2/+8	417	1795 x 700 x 950	230	134	1145
YG-05256	-18/-22	417	1795 x 700 x 950	560	159	3103

* power consumption



3-door refrigerated base – line 700

DE Unterbaukühlisch 3-türig – Linie 700
 RU Холодильный стол 3-дверный – линия 700
 UK Основа охолодження 3-дверна – лінія 700
 LT Šaldomas pagrindas su 3 durimis – linija 700
 LV Aukstuma galds ar 3 durvīm – sērija 700
 CS Chladicí 3-dvěřová základna – řada 700
 SK Chladený základ 3-dverový – linka 700
 HU 3 ajtós hűtőasztal – 700-as sorozat
 RO Masă frigorifică cu 3 uși – linia 700
 ES Mesas frigoríficas con tablero de trabajo – serie 700
 FR Tables de réfrigération avec le plan de travail et à trois portes – série 700
 PT Base de resfriamento de 3 portas – linha 700
 IT Base frigorifera a 3 ante – linea 700
 BG Хладилна основа с 3 врати – линия 700
 EL 3-θύρη βάση ψύξης – γραμμή 700
 ZH 三门冷藏柜-700 mm



SS 201 STAINLESS STEEL	FORCED AIR CIRCULATION	AUTOMATIC DEFROST
max 40kg SHELF	SELF CLOSING DOOR	X4 140-200 mm ADJUSTABLE FEET
		R290 REFRIGERANT



YATO	(°C)	V (l)	(mm)	(W)	(kg)	(kWh/year)*
YG-05259	-2/+8	317	1795 x 700 x 650	230	107	1132

Freezing cabinet for ice cream cuvettes

DE Gefrierschrank für Eisküvetten
 RU Морозильный шкаф для кювет с мороженым
 UK Морозильна камера для ящиків з морозивом
 LT Šaldymo spintos ledų indams
 LV Aukstumaskapis saldējuma kastēm
 CS Mrazicí box na nádoby na led
 SK Mraziaca skriňa pre nádoby na ľad
 HU Fagylaltfagyasztó szekrény
 RO Dulap de congelare pentru cuve de înghețată
 ES Armarios frigoríficos para la heladería
 FR Armoires de stockage pour bacs à crème glacée
 PT Armário de congelamento para bandejas de sorvete
 IT Congelatore per vaschette per gelati
 BG Фризер шкаф за сладолед
 EL Θάλαμος κατάψυξης για δοχεία πάγου
 ZH 冰淇淋冷藏柜



SS 201 STAINLESS STEEL	FORCED AIR CIRCULATION	AUTOMATIC DEFROST	max 40kg SHELF	SELF CLOSING DOOR
----------------------------------	-------------------------------	--------------------------	--------------------------	--------------------------

LOCK	LED LIGHT	X4 140-200 mm ADJUSTABLE FEET	R290 REFRIGERANT
-------------	------------------	---	----------------------------



YATO	(°C)	V (l)	(mm)	(W)	(kg)	(kWh/rok)*
YG-05230	-18/-22	737	740 x 990 x 2010	520	183	3061

* power consumption

Glass cooling cabinet

DE Kühlschrank mit Glastür
 RU Холодильный шкаф со стеклянными дверцами
 UK Холодильна шафа зі склом
 LT Šaldymo spintos su stiklu
 LV Aukstuma skapis ar stikla durvīm
 CS Prosklený chladicí box
 SK Chladená skriňa zasklená
 HU Üvegezett hűtőszekrény
 RO Dulap de răcire cu ușă din sticlă
 ES Armario frigorífico acristalado
 FR Armoire réfrigérée avec des portes en verre
 PT Armário de vidro de refrigeração
 IT Armadio refrigerato vetrato
 BG Хладилен шкаф, остъклен
 EL Θάλαμος κατάψυξης με τζάμι
 ZH 玻璃冷藏柜



SS 201 STAINLESS STEEL	FORCED AIR CIRCULATION	AUTOMATIC DEFROST
GN 2/1	max 40kg SHELF	SELF CLOSING DOOR
		LED LIGHT

LOCK	DOUBLE GLASS	X4 140-200 mm ADJUSTABLE FEET	R290 REFRIGERANT
-------------	---------------------	---	----------------------------



YATO	(°C)	V (l)	(mm)	(W)	(kg)
YG-05225	+2/+8	650	740 x 830 x 2010	215	132

Glass cooling tables – line 700

DE Kühlische mit Glastüren – Linie 700
 RU Холодильные столы со стеклянными дверцами – линия 700
 UK Холодильні столи зі склом – лінія 700
 LT Šaldomi darbastaliai su stiklinimu – linija 700
 LV Aukstuma galdi ar stikla durvīm – sērija 700
 CS Prosklené chladicí stoly – řada 700
 SK Chladené stoly zasklené – linka 700
 HU Üvegezett hűtőasztalok – 700-as sorozat
 RO Mesă rece cu ușă din sticlă – linia 700
 ES Mesas de refrigeración con puertas de cristal – serie 700
 FR Tables de réfrigération avec portes en verre – série 700
 PT Mesas de vidro de refrigeração – linha 700
 IT Armadio refrigerato vetrato – linea 700
 BG Хладилни маси, остъклени – линия 700
 EL Τραπεζι ψύξης με τζάμι – γραμμή 700
 ZH 玻璃冷藏柜 – 700 mm

SS 201 STAINLESS STEEL	FORCED AIR CIRCULATION	AUTOMATIC DEFROST	max 40kg SHELF
----------------------------------	-------------------------------	--------------------------	--------------------------

SELF CLOSING DOOR	LED LIGHT	DOUBLE GLASS	X4 140-200 mm ADJUSTABLE FEET	R290 REFRIGERANT
--------------------------	------------------	---------------------	---	----------------------------



YG-05252 Glass cooling 2-door table – line 700

- 2 coated shelves
- tabletop dimensions: 1360 x 700 mm



YATO	(°C)	V (l)	(mm)	(W)	(kg)
YG-05252	+2/+8	282	1360 x 700 x 850	215	108
YG-05257	+2/+8	417	1795 x 700 x 850	230	134

YG-05257 Glass cooling 3-door table – line 700

- 3 coated shelves
- tabletop dimensions: 1795 x 700 mm



Cooling and freezing cabinets for bakery

DE Kühl- und Gefrierschränke für Backwaren
 RU Холодильные и морозильные шкафы для пекарен
 UK Холодильні та морозильні шафи для хлібобулочних виробів
 LT Kepimo vėsavimo ir šaldymo spintos
 LV Maiznieku aukstuma skapji
 CS Pekařské chladicí a mrazicí boxy
 SK Pekárske, chladené a mraziace skrine
 HU Hűtő- és fagyasztószekrény pékségek számára
 RO Dulapuri de răcire și congelare pentru panificație
 ES Armarios refrigerados pastelería y panadería
 FR Armoires réfrigérées pour pâtisserie et boulangerie
 PT Armários de refrigeração e congelamento para padarias
 IT Armadi da forno refrigerati
 BG Хладилни шкафове и фризерни за хлябни изделия
 EL Θάλαμοι αρτοποιίας ψύξης και κατάψυξης
 ZH 烘焙冷藏柜

YG-05226
Cooling cabinet

YG-05227
Freezing cabinet

YATO	(°C)	V (l)	(mm)	(W)	(kg)	(kWh/year)*
YG-05226	-2/+8	737	740 x 990 x 2010	295	134	1000
YG-05227	-18/-22	737	740 x 990 x 2010	520	183	3061

2-door cooling table for bakery

DE Backwarenkühltisch 2-türig
 RU Пекарский 2-дверный холодильный стол
 UK Холодильний стіл для хлібобулочних виробів 2-дверний
 LT Kepimo šaldomas darbastalis
 LV Maiznieku aukstuma galds ar 2 durvīm
 CS Chladicí pekařské 2-dvéřové stoly
 SK Chladený pekársky stôl 2-dverový
 HU 2 ajtós hűtőasztal pékségek számára
 RO Masă rece cu 2 uși pentru brutărie
 ES Mesas de refrigeración de dos puertas para pastelería y panadería
 FR Tables de réfrigération à deux portes pour pâtisserie et boulangerie
 PT Mesa de refrigeração para padarias 2 portas
 IT Tavolo refrigerato da forno con 2 ante
 BG Хладилна маса за хлябни изделия с 2 врати
 EL Τραπεζι ψύξης αρτοποιίας 2-θυρών
 ZH 烘焙两门冷藏台

YATO	(°C)	V (l)	(mm)	(W)	(kg)	(kWh/year)*
YG-05254	-2/+8	390	1510 x 800 x 845	215	110	1026

* power consumption



- SS 201 STAINLESS STEEL
- FORCED AIR CIRCULATION
- AUTOMATIC DEFROST
- x10 ADJUSTABLE LEVELS
- max 40kg SHELF
- SELF CLOSING DOOR
- LOCK
- LED LIGHT
- x4 140-200mm ADJUSTABLE FEET
- R290 REFRIGERANT



Salad cooling tables

DE Saladetten
 RU Холодильные столы для салата
 UK Холодильні столи для салатів
 LT Šaldomi darbastaliai salotoms
 LV Aukstuma galsi salātiem
 CS Chladicí salátové stoly
 SK Chladené stoly pre šalát
 HU Saláta hűtőasztalok
 RO Masă rece pentru salate

ES Mesas de refrigeración para ensaladas
 FR Tables réfrigérées préparation de salades
 PT Mesas de refrigeração de salada
 IT Tavolo refrigerato per insalate
 BG Хладилни маси за салати
 EL Τραπεζία ψύξης σαλατών
 ZH 色拉冷藏台

Cooling 2-door table with a glass extension

- 2 coated shelves
- top hole for containers GN (4 x GN 1/2 and 3 x GN 1/6)
- tempered glass extension

R600a
REFRIGERANT

Cooling 2-door table with a cover

- 2 coated shelves
- top hole for containers GN (4 x GN 1/2 and 3 x GN 1/6)
- swing top cover

R600a
REFRIGERANT



YATO	(°C)	V (l)	(mm)	(W)	(kg)
YG-05260	+2/+8	240	900 x 700 x 850	170	76

YATO	(°C)	V (l)	(mm)	(W)	(kg)
YG-05262	+2/+8	240	900 x 700 x 876	170	70

Cooling 3-door table with a cover

- 3 coated shelves
- top hole for containers GN (4 x GN 1/1)
- swing top cover

R290
REFRIGERANT



YATO	(°C)	V (l)	(mm)	(W)	(kg)
YG-05290	+2/+8	368	1365 x 700 x 876	240	115

SEE ALSO
GN containers

p. 7

Pizza cooling tables

DE Pizzakühlische
RU Холодильные столы для пиццы
UK Холодильні столи для піци
LT Šaldomi darbastaliai picoms
LV Aukstuma galdi picai
CS Chladicí stoly na pizzu
SK Cladené stoly pre pizzu
HU Pizza hűtőasztalok

RO Masă rece pentru pizza
ES Mesas de refrigeración para pizzas
FR Tables réfrigérées pour pizza
PT Mesas de refrigeração de pizza
IT Tavolo refrigerato per pizza
BG Хладилни маси за пицца
EL Τραπεζία ψύξης πίτσας
ZH 披萨冷藏台

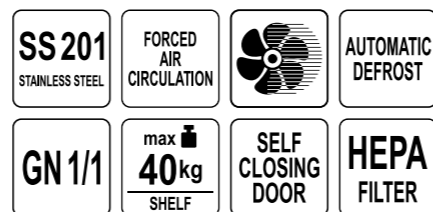

Cooling 2-door table with extension and granite top

- lower compressor – Zanussi
- cooling agent: R600a
- marble work top
- 2 coated shelves with dimensions of 325 x 560 mm
- top hole for GN containers (5 x GN 1/6)

R600a
REFRIGERANT

YATO	(°C)	V (l)	(mm)	(W)	(kg)
YG-05275	+2/+8	240	900 x 700 x 1075	170	105

Pizza cooling 3-door table with extension and granite top

- compressors – Embraco (table) and Zanussi (extension)
- cooling agent: R290 (table), R600a (extension)
- granite work top
- 3 coated shelves with dimensions of 325 x 560 mm
- extension for GN containers (6 x GN 1/4)

R290
REFRIGERANT

R600a
REFRIGERANT

YATO	(°C)	V (l)	(mm)	(W)	(kg)
YG-05305	+2/+8	368	1400 x 700 x 1020 + 1400 x 335 x 435	240 + 110	170 + 27

Pizza cooling 2-door table with 7 drawers and granite top

- side compressor – Embraco
- cooling agent: R290
- granite work top
- 2 coated shelves with dimensions of 408 x 630 mm
- 7 shelves without cooling
- 6 steering wheels, including 3 wheels with brakes

R290
REFRIGERANT

YATO	(°C)	V (l)	(mm)	(W)	(kg)
YG-05310	-2/+8	580	2025 x 800 x 1000	215	332

Accessories for cooling cabinets and tables

DE Zubehör für Kühlschränke und -Tische
RU Аксессуары для холодильных шкафов и столов
UK Аксесуари для шаф і холодильних столів
LT Šaldomų spintų ir darbastalių priedai
LV Aukstuma skapju un galdu piederumi
CS Příslušenství pro chladicí boxy a stoly
SK Wybavenie pre chladené skrine a stoly
HU Kiegészítők hűtőszekrényekhez és hűtőasztalokhoz

RO Accesorii pentru dulapuri frigorifice și mese reci
ES Accesorios para armarios y mesas de refrigeración
FR Accessoires pour armoires et tables de réfrigération
PT Acessórios para armários e mesas de refrigeração
IT Accessori per armadi e tavoli refrigerati
BG Аксесоари за хладилни маси и шкафове
EL Αξεσουάρ για θαλάμους και τραπέζια ψύξης
ZH 冷藏柜冷藏台配件

Coated shelves



PVC
COATED SHELVES

YATO	(mm)	FOR:
YG-05400	534 x 650	YG-05200, YG-05201, YG-05210, YG-05211, YG-05225

YATO	(mm)	FOR:
YG-05403	534 x 650	YG-05215, YG-05216, YG-05220, YG-05221



YATO	(mm)	FOR:
YG-05406	333 x 530	YG-05250, YG-05251, YG-05252, YG-05255, YG-05256, YG-05257, YG-05259, YG-05270, YG-05300
YG-05409	325 x 560	YG-05260, YG-05262, YG-05275, YG-05290, YG-05305
YG-05412	408 x 630	YG-05310, YG-05254
YG-05420	333 x 430	YG-05253, YG-05258

Shelf guides



YATO	L/R*	FOR:
YG-05401	L	YG-05200, YG-05201, YG-05210, YG-05211, YG-05225
YG-05402	R	YG-05200, YG-05201, YG-05210, YG-05211, YG-05225
YG-05404	L	YG-05215, YG-05216, YG-05220, YG-05221
YG-05405	R	YG-05215, YG-05216, YG-05220, YG-05221
YG-05407	L	YG-05250, YG-05251, YG-05252, YG-05255, YG-05256, YG-05257, YG-05259, YG-05270, YG-05300
YG-05408	R	YG-05250, YG-05251, YG-05252, YG-05255, YG-05256, YG-05257, YG-05259, YG-05270, YG-05300
YG-05410	L	YG-05260, YG-05262, YG-05275, YG-05290, YG-05305
YG-05411	R	YG-05260, YG-05262, YG-05275, YG-05290, YG-05305
YG-05413	L	YG-05310, YG-05254
YG-05414	R	YG-05310, YG-05254
YG-05421	L	YG-05253, YG-05258
YG-05422	R	YG-05253, YG-05258

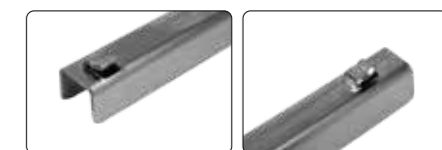

YATO	L/R*	FOR:
YG-05423	L	YG-05226
YG-05424	R	YG-05226
YG-05425	L	YG-05227
YG-05426	R	YG-05227



* L – left, R – right

Cooling extensions

- DE Kühlauflätze
- RU Холодильные витрины
- UK Холодильні надставки
- LT Aušinimo pratėsimai
- LV Aukstuma uzliktņi
- CS Chladicí nástavky
- SK Chladiaci nadstavec
- HU Hűtő feltétek
- RO Extensii pentru mese reci
- ES Vitrinas expositoras de comida fría
- FR Vitrines réfrigérées pour aliments
- PT Extensões de refrigeração
- IT Unità di refrigerazione
- BG Хладилно надграждане
- EL Ψυγείο μπουφέ
- ZH 其他冷藏设备



- SS 201**
STAINLESS STEEL
- AUTOMATIC DEFROST**
- DIGITAL TEMPERATURE CONTROLLER**
- HARDENED GLASS**
- R600a**
REFRIGERANT
- HEPA FILTER**



SEE ALSO
GN containers



p. 7

YATO	(°C)		(mm)	(W)	(kg)
YG-05320	+2/+8	5 x GN 1/4	1200 x 335 x 435	110	25
YG-05321	+2/+8	6 x GN 1/4	1400 x 335 x 435	110	27
YG-05322	+2/+8	7 x GN 1/4	1500 x 335 x 435	110	29
YG-05323	+2/+8	8 x GN 1/4	1800 x 335 x 435	110	32
YG-05330	+2/+8	6 x GN 1/3	1400 x 395 x 435	110	30
YG-05331	+2/+8	7 x GN 1/3	1600 x 395 x 435	110	32
YG-05332	+2/+8	9 x GN 1/3	2000 x 395 x 435	110	36

Refrigerated display cases for sushi

- DE Sushi und Tapas Belegstation
- RU Холодильные витрины для суши
- UK Холодильні вітрини для суши
- LT Sušių šaldymo vitrina
- LV Aukstuma vitrinas suši
- CS Chladicí pulty na sushi
- SK Chladené výklady pre sushi
- HU Sushi hűtővitrin
- RO Vitrină frigorifică pentru sushi
- ES Vitrinas expositoras de sushi
- FR Vitrines réfrigérées pour sushi
- PT Vitrinas de refrigeração de sushi
- IT Vetrine refrigerate per sushi
- BG Хладилни витрини за суши
- EL Βιτρίνα ψύξης σουσί
- ZH 寿司冷藏展示柜



- AUTOMATIC DEFROST**
- DIGITAL TEMPERATURE CONTROLLER**
- LED LIGHT**
- R600a**
REFRIGERANT



• panoramic, rounded front glass

YATO	(°C)		(mm)	(W)	(kg)
YG-05000	0/+6	4 x GN 1/3	1177 x 420 x 295	125	34.5
YG-05001	0/+6	5 x GN 1/3	1350 x 420 x 295	135	38.5
YG-05002	0/+6	6 x GN 1/3	1530 x 420 x 295	145	41.5
YG-05005	0/+6	5 x GN 1/2	1800 x 420 x 295	160	45



• glass shelf

YATO	(°C)		(mm)	(W)	(kg)
YG-05007	0/+6	5 x GN 1/2	1755 x 395 x 375	180	53

Refrigerated display cases for bottles

- DE Kühlvitrinen für Flaschen
- RU Холодильные витрины для бутылок
- UK Холодильні вітрини для пляшок
- LT Butelių šaldymo vitrina
- LV Aukstuma vitrinas pudelēm
- CS Chladicí pulty na láhve
- SK Chladené výklady pre fľaše
- HU Üveg hűtővitrin
- RO Dulap frigorific pentru băuturi
- ES Vitrinas refrigeradas para botellas
- FR Vitrines réfrigérées pour bouteilles
- PT Vitrinas de refrigeração para garrafas
- IT Vetrine refrigerate per bottiglie
- BG Хладилни витрини за бутилки
- EL Βιτρίνες ψύξης μπουκαλιών
- ZH 冷藏展示柜



1-door case

• 2 chrome plated shelves
with dimensions of 515 x 350 mm



YATO	(°C)	V (l)	(mm)	(W)	(kg)
YG-05350	+2/+8	142	600 x 515 x 905	180	83

2-door case

• 4 chrome plated shelves
with dimensions of 835 x 350 mm



YATO	(°C)	V (l)	(mm)	(W)	(kg)
YG-05355	+2/+8	227	920 x 515 x 905	200	102

2-door case (sliding doors)

• 4 chrome plated shelves
with dimensions of 835 x 350 mm



YATO	(°C)	V (l)	(mm)	(W)	(kg)
YG-05356	+2/+8	227	920 x 515 x 905	200	102

3-door case

• 6 chrome plated shelves:
middle with dimensions
445 x 350 mm
and side 400 x 350 mm



YATO	(°C)	V (l)	(mm)	(W)	(kg)
YG-05360	+2/+8	341	1350 x 515 x 910	225	130

- SS AI**
- FORCED AIR CIRCULATION**
- LED LIGHT**
- LOCK**

- SELF CLOSING DOOR**
- HARDENED GLASS**
- CHROME PLATED SHELVES**
- R600a**
REFRIGERANT
- HEPA FILTER**



Accessories for refrigerated display cases for bottles



DE Zubehör für Kühlvitrinen für Flaschen

RU Аксессуары для холодильных витрин для бутылок

UK Аксесуари для холодильних установок для пляшок

LT Butelių šaldymo vitrinų priedai

LV Aukstuma vitrinu pudelēm piederumi

CS Příslušenství k chladicím pultům na láhve

SK Výbavenie pre chladené výklady pre fľaše

HU Kiegészítők üveg hűtővitrinekhez

RO Accesorii pentru dulapuri frigorifice pentru băuturi

ES Accesorios para vitrinas refrigeradas para botellas

FR Accessoires pour vitrines réfrigérées pour bouteilles

PT Acessórios para vitrinas de refrigeração para garrafas

IT Accessori per vetrine refrigerate per bottiglie

BG Аксесоари за хладилни витрини за бутилки

EL Αξεσουάρ για βιτρίνες ψύξης μπουκαλιών

ZH 冷藏展示柜配件

Chrome plated shelves

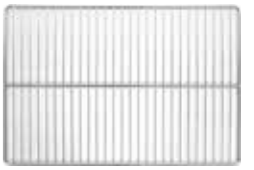

YATO	(mm)	FOR:
YG-05415	515 x 350	YG-05350

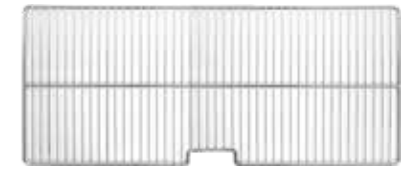

YATO	(mm)	FOR:
YG-05416	835 x 350	YG-05355, YG-05356



• middle shelf

YATO	(mm)	FOR:
YG-05417	445 x 350	YG-05360

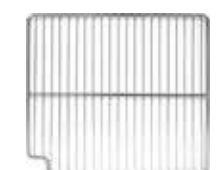

• left/right shelf

YATO	(mm)	FOR:
YG-05418	400 x 350	YG-05360

K-type shelf holder



YATO	(mm)	FOR:
YG-05419	400 x 350	YG-05350, YG-05355, YG-05356, YG-05360



Refrigerated display cases

- DE Kühlvitriren
- RU Холодильные витрины
- UK Холодильні вітрини
- LT Šaldymo vitrinos
- LV Aukstuma vitrinas
- CS Chladicí pulty
- SK Chladené výklady
- HU Hűtővitrinek
- RO Vitrine frigorifice
- ES Vitrinas refrigeradas
- FR Vitrines réfrigérées
- PT Vitrinas de refrigeração
- IT Vetrine refrigerate
- BG Хладилни витрини
- EL Βιτρίνες ψύξης
- ZH 冷藏展示柜



- AUTOMATIC DEFROST
- DIGITAL TEMPERATURE CONTROLLER
- LED LIGHT
- R600a REFRIGERANT
- ADJUSTABLE SHELVES



YATO	(°C)	V (l)	(mm)	(W)	COLOUR	(kg)
YG-05020	0/+12	100	682 x 450 x 675	160	●	39.1
YG-05021	0/+12	100	682 x 450 x 675	160	○	39.1
YG-05022	0/+12	100	682 x 450 x 675	160	○	39.1



YATO	(°C)	V (l)	(mm)	(W)	(kg)
YG-05025	0/+12	120	688 x 568 x 686	160	64



Refrigerated display cases

- DE Kühlvitriren
- RO Vitrine frigorifice
- RU Холодильные витрины
- ES Vitrinas refrigeradas
- UK Холодильні вітрини
- FR Vitrines réfrigérées
- LT Šaldymo vitrinos
- PT Vitrinas de refrigeração
- LV Aukstuma vitrinas
- IT Vetrine refrigerate
- CS Chladicí pulty
- BG Хладилни витрини
- SK Chladené výklady
- EL Βιτρίνες ψύξης
- ZH 冷藏展示柜

- AUTOMATIC DEFROST
- DIGITAL TEMPERATURE CONTROLLER
- LED LIGHT
- ADJUSTABLE SHELVES

- 4 SIDE DOUBLE GLASS
- R290 REFRIGERANT
- 360° 4x



YATO	(°C)	V (l)	(mm)	(W)	(kg)
YG-05040	+2/+8	300	650 x 805 x 1445	450	135
YG-05045	+2/+8	400	900 x 805 x 1445	450	160



Refrigerated display cases

DE Kühlvitriren
RU Холодильные витрины
UK Холодильні вітрини
LT Šaldymo vitrinos
LV Aukstuma vitrinas
CS Chladicí pulty
SK Chladené výklady
HU Hűtővitrinek
RO Vitrine frigorifice
ES Vitrinas refrigeradas
FR Vitrines réfrigérées
PT Vitrinas de refrigeração
IT Vetrine refrigerate
BG Хладилни витрини
EL Βιτρίνες ψύξης
ZH 冷藏展示柜



A G C

YATO	(°C)	V (l)	(mm)	(W)	COLOUR	(kg)
YG-05055	0/+6	78	428 x 386 x 960	164	○	33.8
YG-05056	0/+6	78	428 x 386 x 960	164	●	33.8
YG-05057	0/+6	78	428 x 386 x 960	164	○	33.8

Refrigerated display case

DE Kühlvitrine
RU Холодильная витрина
UK Холодильна вітрина
LT Šaldymo vitrina
LV Aukstuma vitrina
CS Chladicí pult
SK Chladený výklad
HU Hűtővitrin
RO Vitrine frigorifice
ES Vitrina refrigerada
FR Vitrine réfrigérée
PT Vitrina de refrigeração
IT Vetrina refrigerata
BG Хладилна витрина
EL Βιτρίνα ψύξης
ZH 冷藏展示柜



A G C

YATO	(°C)	V (l)	(mm)	(W)	(kg)
YG-05060	0/+6	78	430 x 390 x 986	180	42

Refrigerated display cases

DE Kühlvitriren
RU Холодильные витрины
UK Холодильні вітрини
LT Šaldymo vitrinos
LV Aukstuma vitrinas
CS Chladicí pulty
SK Chladené výklady
HU Hűtővitrinek
RO Vitrine frigorifice
ES Vitrinas refrigeradas
FR Vitrines réfrigérées
PT Vitrinas de refrigeração
IT Vetrine refrigerate
BG Хладилни витрини
EL Βιτρίνες ψύξης
ZH 冷藏展示柜



A G C

YATO	(°C)	V (l)	(mm)	(W)	(kg)
YG-05064	0/+6	270	650 x 650 x 1500	636	140
YG-05068	0/+6	400	650 x 650 x 1908	636	175

Refrigerated display case

DE Kühlvitrine
RU Холодильная витрина
UK Холодильна вітрина
LT Šaldymo vitrina
LV Aukstuma vitrina
CS Chladicí pult
SK Chladený výklad
HU Hűtővitrin
RO Vitrine frigorifice
ES Vitrina refrigerada
FR Vitrine réfrigérée
PT Vitrina de refrigeração
IT Vetrina refrigerata
BG Хладилна витрина
EL Βιτρίνα ψύξης
ZH 冷藏展示柜

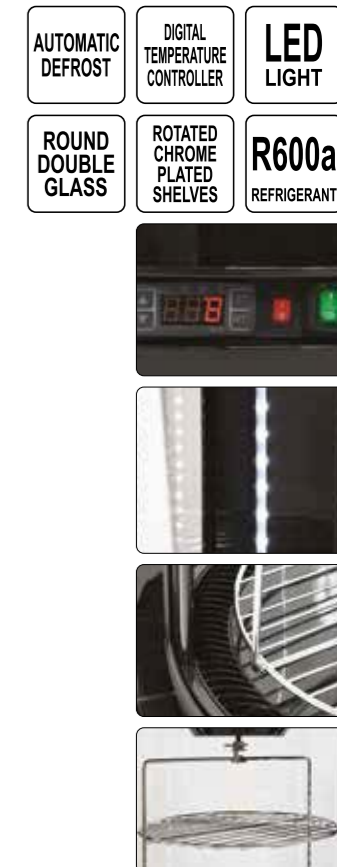

A G C

YATO	(°C)	V (l)	(mm)	(W)	(kg)
YG-05090	+2/+12	73	504 x 504 x 1060	170	45

Refrigerated display cases

- DE Kühlvitrienen
- RU Холодильные витрины
- UK Холодильні вітрини
- LT Šaldymo vitrinos
- LV Aukstuma vitrinas
- CS Chladicí pulty
- SK Chladené výklady
- HU Hűtővitrinek
- RO Vitrine frigorifice
- ES Vitrinas refrigeradas
- FR Vitrines réfrigérées
- PT Vitrinas de refrigeração
- IT Vetrine refrigerate
- BG Хладилни витрини
- EL Βιτρίνες ψύξης
- ZH 冷藏展示柜



- cooling agent: R600a
- 3 adjustable glass shelves with diameter of 390 mm

YATO	(°C)	V (l)	(mm)	(W)	(kg)
YG-05094	+2/+8	100	480 x 480 x 1030	170	50



- cooling agent: R290
- 4 adjustable glass shelves with diameter of 540 mm

YATO	(°C)	V (l)	(mm)	(W)	(kg)
YG-05098	+2/+8	400	680 x 680 x 1750	450	127

FORCED AIR CIRCULATION

AUTOMATIC DEFROST

DIGITAL TEMPERATURE CONTROLLER

LED LIGHT

ROUND DOUBLE GLASS

AUTOMATIC DOOR CLOSER

ADJUSTABLE GLASS SHELVES

R290
REFRIGERANT

360°
4x



Sink with knee switch

- DE Knie-Kontakt-Handwaschbecken
- RU Рукомойник с коленным приводом
- UK Колінна раковина
- LT Bekontaktė virtuvinė plautuvė
- LV Ceļgalu izlietne
- CS Kolenní umyvadlo
- SK Kolenné umývadlo
- HU Kézmosó
- RO Chiuvetă cu acționare la genunchi
- ES Lavamanos rodilla
- FR Lavabo à commande au genou
- PT Pia com acionamento por joelho
- IT Lavabo con comando a ginocchio
- BG Безконтактна мивка с бутон за коляно
- EL Υγειονομικός νιπτήρας με πλάτη
- ZH 不锈钢洗涤槽



SS 304/201
STAINLESS STEEL

40mm
DRAIN HOLE

TEMPERATURE
REGULATION

WATER
STOP
VALVE



YATO	(mm)
YG-10010	400 x 330 x 570

Automatic water softener with bypass

- DE Automatischer Wasserenthärter mit Bypass
- RU Автоматический смягчитель воды с байпасом
- UK Автоматичний пом'якшувач води з байпасом
- LT Automatinis vandens minkštintuvas su apėjimu
- LV Automātiskais ūdens mīkstinātājs ar apeju
- CS Automatický změkčovač vody z bypassem
- SK Automatický prístroj na zmäkčenie vody s bypassom
- HU Automatikus vízlágyító bypass-szal
- RO Aparat de dedurizare a apei cu bypass
- ES Descalcificador automático con bypass
- FR Adoucisseur d'eau automatique, jeu de clés Bypass inclus
- PT Abrandador de água automático com bypass
- IT Addolcitore automatico d'acqua con bypass
- BG Автоматичен омекотител за вода с байпас
- EL Αυτόματο μαλακτικό νερού με bypass
- ZH 软水机



500l/h

5L
CAPACITY

5-38°C
WATER
TEMPERATURE

0.1-0.6
MPa
WORKING
PRESSURE

PE

3/4"
CONNECTION

BYPASS
VALVE

15kg
SALT TANK
CAPACITY



YATO	(l/h)	(MPa)	(mm)	(kg)
YG-09510	500	0.1-0.6	510 x 520 x 215	9

TOYA S.A.

ul. Sołtysowicka 13-15
51-168 Wrocław
☎ (+48 71) 32 46 200
fax: (+48 71) 32 46 370
sales@yato.pl (domestic)
export@yato.pl (export)
import@yato.pl (import)

WARSAW BRANCH

Teren ProLogis Park Nadarzyn
al. Kasztanowa 160
05-831 Młochów k. Warszawy
☎ (+48 22) 73 82 800
☎ (+48 22) 73 82 828
sales@yato.pl (domestic)
export@yato.pl (export)

TOYA ROMANIA S.A.

Soseaua Stefanesti 8-8a
077175 Stefanestii De Jos
☎ (+40 031) 710 8692
office@yato.ro

YATO TOOLS (SHANGHAI) Co., Ltd.

YATO TOOLS (JIAXING) Co., Ltd.
No. 1, Lane 1300
East Kangqiao Road
Shanghai, China 201315
☎ (+86 21) 681 829 50
fax: (+86 21) 681 829 51
yato@yato-sh.com



V2.22

YOUR TRUSTED SUPPLIER

yatogastro.com